

Approval body for construction products
and types of construction

Bautechnisches Prüfamt

An institution established by the Federal and
Laender Governments



European Technical
Assessment

ETA-13/0172
of 4 April 2018

English translation prepared by DIBt - Original version in German language

General Part

Technical Assessment Body issuing the
European Technical Assessment:

Deutsches Institut für Bautechnik

Trade name of the construction product

Hilti powder-actuated fastener X-ENP2K-20 L15,
X-ENP2K-20 L15 MX

Product family
to which the construction product belongs

Hilti powder actuated fasteners X-ENP2K-20 L15 and
X-ENP2K-20 L15 MX in combination with Hilti fastening
tool DX 76 PTR

Manufacturer

Hilti AG
Feldkircherstraße 100
9494 Schaan
FÜRSTENTUM LIECHTENSTEIN

Manufacturing plant

Hilti AG
Feldkircherstraße 100
9494 Schaan
Liechtenstein

This European Technical Assessment
contains

12 pages including 7 annexes which form an integral part
of this assessment

This European Technical Assessment is
issued in accordance with Regulation (EU)
No 305/2011, on the basis of

EAD 330153-00-0602

European Technical Assessment

ETA-13/0172

English translation prepared by DIBt

Page 2 of 12 | 4 April 2018

The European Technical Assessment is issued by the Technical Assessment Body in its official language. Translations of this European Technical Assessment in other languages shall fully correspond to the original issued document and shall be identified as such.

Communication of this European Technical Assessment, including transmission by electronic means, shall be in full. However, partial reproduction may only be made with the written consent of the issuing Technical Assessment Body. Any partial reproduction shall be identified as such.

This European Technical Assessment may be withdrawn by the issuing Technical Assessment Body, in particular pursuant to information by the Commission in accordance with Article 25(3) of Regulation (EU) No 305/2011.

Specific part

1 Technical description of the product

The products are mechanical fasteners (powder-actuated fasteners / cartridge fired pins)¹ made of carbon steel. The fasteners comprise a pin (nominal diameter: 3.7 mm) which is assembled with two washers. The washers serve to guide the fasteners while they are being driven into the base material. The washers also serve to improve the bearing area. Special fastening tools are used in order to install the fasteners. The driving force of the fastening tools is provided by the power load of the used cartridge (several cartridge strengths available) and can be altered at the fastening tools within a limit. The application limit depends on the strength and the thickness of the base material.

The dimensions and materials of the fasteners are given in Annex A1. The difference of the fastening tools is the kind of feeding: single fasteners or collated in fastener strips. The following overview shows the 2 powder-actuated fastening systems approved.

Fastener	Fastening tool	Features
X-ENP2K-20 L15	DX 76 PTR	With single fastener guide X-76-F-15-PTR.
X-ENP2K-20 L15 MX	DX 76 PTR	With magazine MX 76-PTR. The fasteners are collated in a MX fastener strip, which is indicated in the fastener designation.

Fasteners, fastening tools and cartridges are shown in Annex A1 and Annex A2.

The fastener and the corresponding connections are subject to tension and/or shear forces (see Annex B2).

2 Specification of the intended use in accordance with the applicable European Assessment Document

The intended use is specified in Annex B1 and B2.

The performances given in Section 3 are only valid if the fastener is used in compliance with the specifications and conditions given in Annex B1 to B3.

The verifications and assessment methods on which this European Technical Assessment is based lead to the assumption of a working life of the fastener of at least 25 years. The indications given on the working life cannot be interpreted as a guarantee given by the producer, but are to be regarded only as a means for choosing the right products in relation to the expected economically reasonable working life of the works.

¹ Both terms (powder-actuated fastener and cartridge fired pin) are commonly used.

3 Performance of the product and references to the methods used for its assessment

3.1 Mechanical resistance and stability (BWR 1)

Essential characteristic	Performance
Tension resistance of connection	See Annex C1 and C2
Shear resistance of connection	See Annex C1 and C2
Design resistance in case of combined tension and shear forces (interaction)	See Annex B1
Check of deformation capacity in case of constraining forces due to temperature	See Annex B1
Determination and check of application limits	See Annex C1

3.2 Safety in case of fire (BWR 2)

Essential characteristic	Performance
Reaction to fire	Class A1
Resistance to fire	See Annex B1

3.3 Hygiene, health and the environment (BWR 3)

Essential characteristic	Performance
Content and/or release of dangerous substances	no performance determined

3.4 Safety and assessability in use (BWR 4)

Essential characteristic	Performance
Tension resistance of connection	See Annex C1 and C2
Shear resistance of connection	See Annex C1 and C2
Design resistance in case of combined tension and shear forces (interaction)	See Annex B1
Check of deformation capacity in case of constraining forces due to temperature	See Annex B1
Determination and check of application limits	See Annex C1

3.5 Sustainable use of natural resources (BWR 7)

Essential characteristic	Performance
Durability	See Annex B1, use conditions

4 Assessment and verification of constancy of performance (AVCP) system applied, with reference to its legal base

In accordance with EAD No. 330153-00-0602, the applicable European legal act is: Decision 1998/214/EC, amended by 2001/596/EC.

The system to be applied is: 2+

5 Technical details necessary for the implementation of the AVCP system, as provided for in the applicable EAD

Technical details necessary for the implementation of the AVCP system are laid down in the control plan deposited with Deutsches Institut für Bautechnik.

Issued in Berlin on 4 April 2018 by Deutsches Institut für Bautechnik

BD Dipl.-Ing. Andreas Kummerow
Head of Department

beglaubigt:
Schult

Powder-actuated fastener / cartridge fired pin X-ENP2K-20 L15

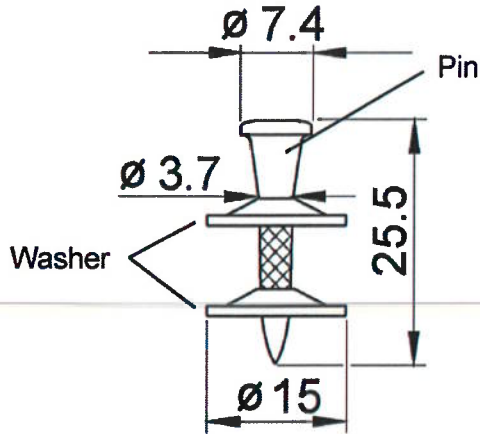

Material:

Pin Steel C67S in keeping with EN 10132-4 tempered, quenched and galvanised. Nominal hardness: 56 HRC

Washer Steel DC01 galvanised according to EN 10139

Zinc coating to resist 2 cycles Kesternich test with 2 l SO₂ according to EN 3231 without red rust

Powder-actuated fastening tool DX 76 PTR and cartridges



Detail of wheel on tool allowing continuous regulation of the driving energy within one cartridge colour:

Setting 1:
Minimum energy
Setting 4:
Maximum energy

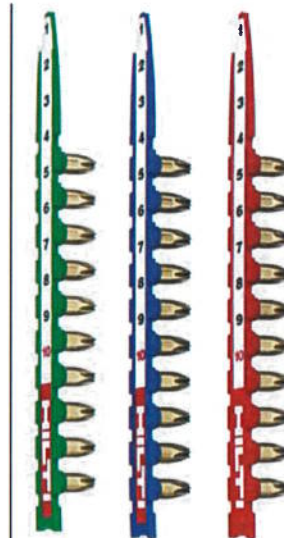





Cartridges 6,8/18 M10 with 10 cartridges per plastic strip for DX 76 PTR

Green: Low load (level 3)
Blue: Medium load (level 5)
Red: Medium high load (level 6)

Hilti powder-actuated fastener X-ENP2K-20 L15 (MX)

Product description
Product, dimension and material

Annex A1

<p>Single Fastener: X-ENP2K-20 L15</p>	  <p>DX 76 PTR with single-fastener guide X-76-F-15-PTR</p>	
<p>Collated fasteners for magazine tools: X-ENP2K-20 L15 MX</p>	  <p>DX 76 PTR with magazine MX 76-PTR</p>	
<p>Hilti powder-actuated fastener X-ENP2K-20 L15 (MX)</p>		<p>Annex A2</p>
<p>Product description Powder-actuated fastening tools</p>		

Specification of intended use

The fasteners are intended to be used for fastening of steel sheeting to steel members. The sheeting can either be used as cladding or as load bearing wall and roof element.

Anchorage subject to:

- Predominantly static and quasi-static loads. Wind loads are regarded as predominantly static.

Fixed material sheeting (flat products and therewith produced profiled products):

- Steel sheeting of steel grades \geq S280 according to EN 10346:2015 and a thickness $t_f = 0.75$ mm to 1.5 mm (with max 4 mm for 2 to 4 layers).
- Other thin gauge steel members.

Base materials:

- Structural steel \geq S235 with a nominal thickness $t_{fl} \geq 3$ mm provided the relevant application limits (Annex C1) are taken into account.
- For hot-dipped galvanized base materials a zinc coating up to approximately 150 μ m is allowed, for powder-coated or painted base materials a dry coat thickness of up to 160 μ m is allowed.

Use conditions (Environmental conditions):

- The intended use only comprises fasteners and connections which are not directly exposed to external weather conditions or moist atmospheres.

Design:

- The verification concept stated in EN 1990:2002 + A1:2005 + A1:2005/AC:2010 is used for the design of the connection made with the fasteners. The characteristic values (shear and tension resistance) according to Annex C1 are used for the design of the entire connection.
- The partial safety factor of $\gamma_M = 1.25$ is used in order to determine the corresponding design resistance, provided no values are given in national regulations of the member state in which the fastener is used or in the respective National Annex to Eurocode 3.
- In case of combined tension and shear forces the linear interaction formula according to EN 1993-1-3:2006 + AC:2009, section 8.3 (8) is taken into account.
- The possibly required reduction of the tension resistance due to the position of the fastener is taken into account in accordance with EN 1993-1-3:2006 + AC:2009, section 8.3 (7) and Fig. 8.2.
- For the type of connection (a, b, c, d) listed in Annex C1 and for the fastening patterns listed in Annex C2 it is not necessary to take into account the effect of constraints due to temperature for the steel grades S280 to S350 in accordance with EN 10346:2015.
- Dimensions, material properties, application limits and nail head standoffs as stated in the ETA are observed.
- Resistance to fire: The part of the structure in which the powder-actuated fasteners X-ENP2K-20 L15 are intended to be installed shall be tested, using the test method relevant for the corresponding fire resistance class, in order to be classified according to the appropriate part of EN 13501.

Installation:

- The installation is only carried out according to the manufacturer's instructions. The manufacturer hands over the assembly instructions to the assembler.
- The installation is carried out such that the fasteners are replaceable if necessary.
- The steel sheeting is in direct contact with the steel base material in the area of the connection.
- The conformity of the installed fastener with the provisions of the ETA is attested by the executing company.

Hilti powder-actuated fastener X-ENP2K-20 L15 (MX)

Intended use
Specification

Annex B1

Types of connection and corresponding loading conditions

	Types of connection			
	Type a	Type b	Type c	Type d
Type of loading	Single connection	Side lap connection	End overlap connection	Side lap + end overlap connection
Shear loading				
Tension loading				

Fixed material thickness t_I , base material thickness t_{II}
and nail head standoff h_{NVS}

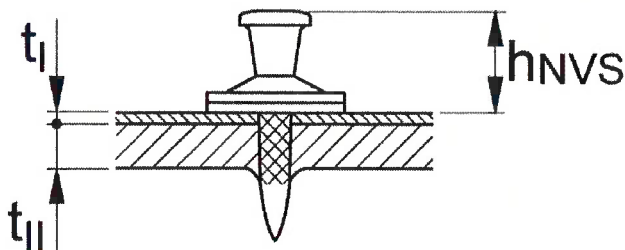

Hilti powder-actuated fastener X-ENP2K-20 L15 (MX)

Intended use
Types of connection

Annex B2

Instructions for use

- The powder-actuated fasteners X-ENP2K-20 L15 and X-ENP2K-20 L15 MX are driven by using the powder-actuated fastening tool DX 76 PTR as shown in Annex A2.
- The steel sheeting is in direct contact with the steel supporting structure at the area of the connection. Cartridge selection and tool energy settings in order to cover the application limit diagram are taken into account as given in Annex C1.
- Installation safety tests are to be carried out (e.g. check of nail head standoff h_{NVS}), provided the fitness of the recommended cartridge cannot be checked otherwise. Fine regulation of the driving energy by using the wheel on the fastening tool is acceptable in order to meet the nail head standoff h_{NVS} .
- The powder-actuated fastener is properly set if the metal sheet is tightened against the steel surface and the nail head standoff h_{NVS} is in accordance with the requirements given in Annex C1.

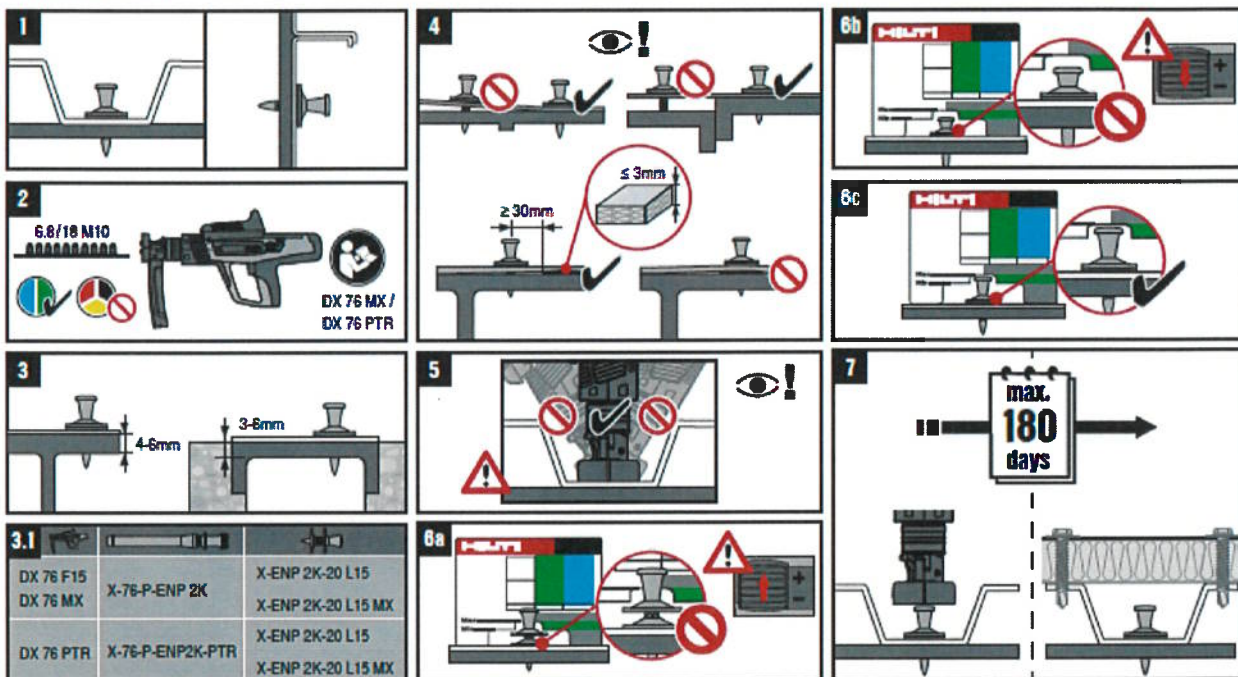

Specific geometric details:

Fastening to cold-formed C- and Z-sections with a thickness from 2.9 to 4.0 mm

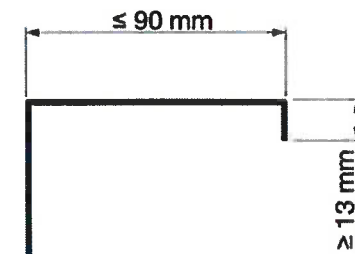

Grade: \geq S320 GD according to EN 10346:2015

Fastening to U-shape concrete inlays with a nominal thickness t_{II} of 3 mm.

$$t_{II} = 3.0 \pm 0.3 \text{ mm}$$

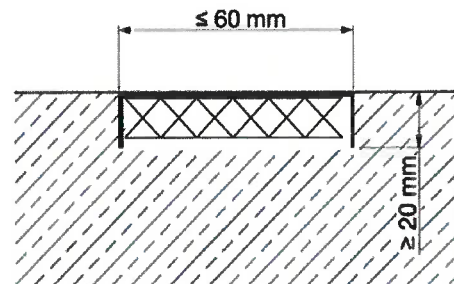

Hilti powder-actuated fastener X-ENP2K-20 L15 (MX)

Intended use

Instructions for use and specific geometric details

Annex B3

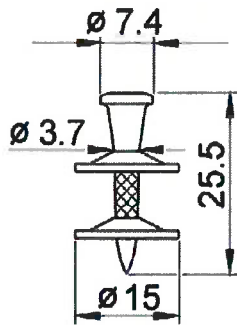

Powder-actuated fastener and fastening tool:

X-ENP2K-20 L15 with DX 76 PTR and single-fastener guide X-76-F-15-PTR

X-ENP2K-20 L15 MX with DX 76 PTR and fastener magazine MX 76-PTR

Piston: **X-76-P-ENP2K-PTR**

Cartridges: **6.8/18 M10**

Installation control:

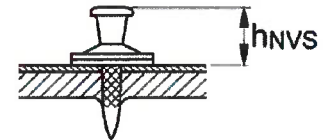

$h_{NVS} = 7 \text{ to } 11 \text{ mm}$

Characteristic shear and tension resistance V_{Rk} and N_{Rk}

t_l [mm]	$3 \text{ mm} \leq t_l < 4 \text{ mm}$			$4 \text{ mm} \leq t_l < 5 \text{ mm}$			$5 \text{ mm} \leq t_l \leq 6 \text{ mm}$		
	V_{Rk} [kN]	N_{Rk} [kN]	Types of conn.	V_{Rk} [kN]	N_{Rk} [kN]	Types of conn.	V_{Rk} [kN]	N_{Rk} [kN]	Types of conn.
0.75	4.7	6.0	a,c	4.7	6.3	a,b,c,d	4.7	6.3	a,b,c,d
0.88	5.4	6.0	a,c	5.4	7.2	a,c,d	5.4	7.2	a,(b)*,c,d
1.00	6.0	6.0	a,c	6.0	8.0	a,c,d	6.0	8.0	a,(b)*,c,d
1.13	-	-	-	7.0	8.4	a,c	7.0	8.4	a,c
1.25	-	-	-	8.0	8.8	a,c	8.0	8.8	a,c
1.50	-	-	-	8.6	8.8	a	8.6	8.8	a

* Fastening type (b) covered for $5 \text{ mm} \leq t_l < 6 \text{ mm}$, if N_{Rk} is reduced to 6.6 kN
Fastening type (b) fully covered for $t_l = 6 \text{ mm}$

Design shear and tension resistance V_{Rd} and N_{Rd}

$$V_{Rd} = V_{Rk} / \gamma_M$$

$$N_{Rd} = \alpha_{cycl} \cdot N_{Rk} / \gamma_M \text{ with } \alpha_{cycl} = 1.0 \text{ for all sheeting thickness } t_l$$

α_{cycl} considers the effect of repeated wind loads

$\gamma_M = 1.25$ in the absence of national regulations

Application limit diagram

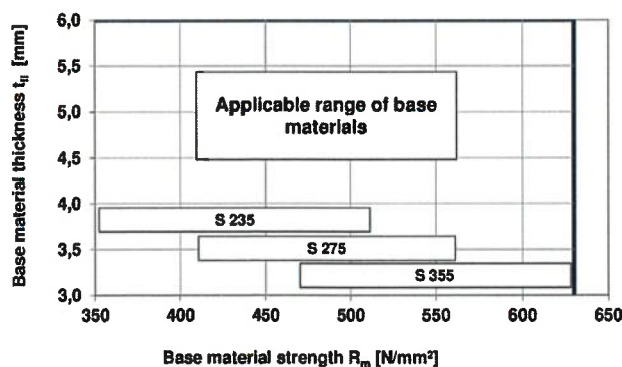

Base material:
Structural steel S235, S275 and S355 in qualities JR, JO, J2, K2 acc. to EN 10025-2; min. nominal thickness = 3 mm (specific details on min. thickness see Annex B3); $t_{l,max} = 6 \text{ mm}$

Cartridge selection and tool energy setting

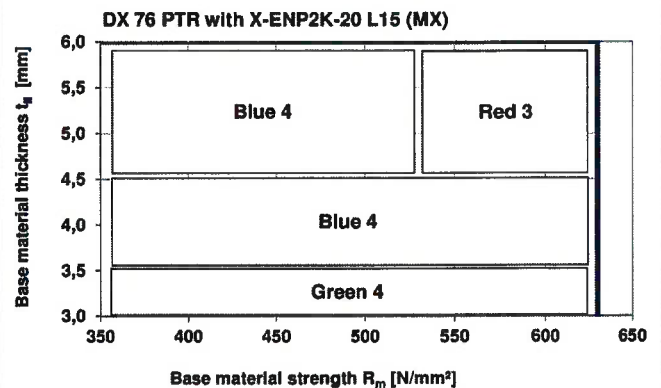

Job-site trials are recommended to prove proper energy setting. If required, fine adjustment of energy setting.

Hilti powder-actuated fastener X-ENP2K-20 L15 (MX)

Performances

X-ENP2K-20 L15 with tool DX 76 PTR: Characteristic and design resistance, application limit, cartridge selection and nail head standoff

Annex C1

English translation prepared by DIBt

Characteristic tension resistances n_{Rk} [kN/m] and shear resistances v_{Rk} [kN/m] per unit length, taking the effect of thermal constraints into account

N_{Rk} and V_{Rk} according to Annex C1

w ... width of the panel sheet

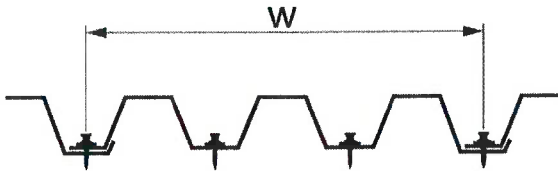

$$n_{Rk} = 0.9 \cdot 2 \cdot N_{Rk} / w$$

$$v_{Rk} = 2 \cdot V_{Rk} / w$$

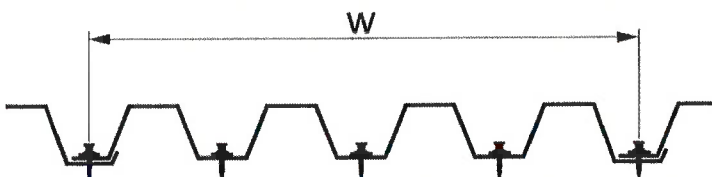

$$n_{Rk} = 0.9 \cdot 3 \cdot N_{Rk} / w$$

$$v_{Rk} = 3 \cdot V_{Rk} / w$$

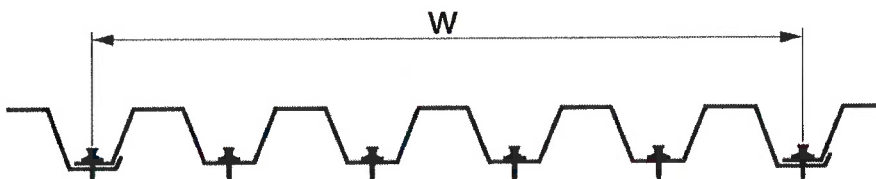

$$n_{Rk} = 0.9 \cdot 4 \cdot N_{Rk} / w$$

$$v_{Rk} = 4 \cdot V_{Rk} / w$$

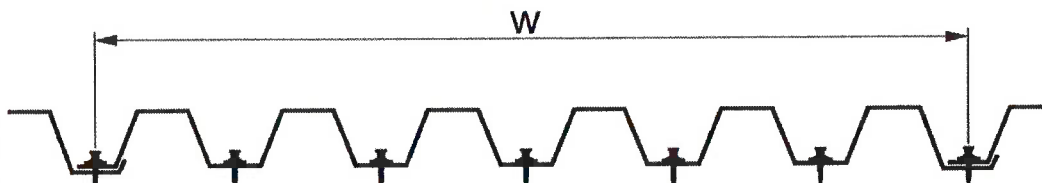

$$n_{Rk} = 0.9 \cdot 5 \cdot N_{Rk} / w$$

$$v_{Rk} = 5 \cdot V_{Rk} / w$$

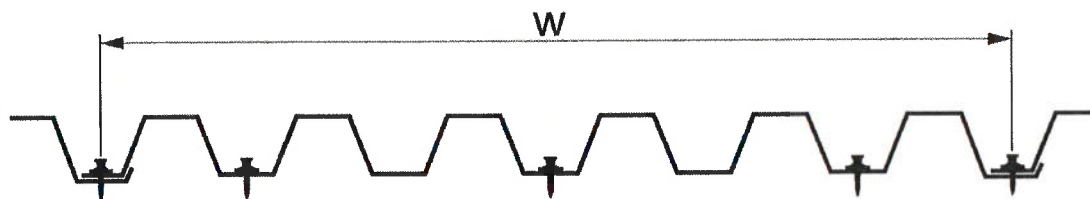

$$n_{Rk} = 3 \cdot N_{Rk} / w$$

$$v_{Rk} = 3 \cdot V_{Rk} / w$$

Remark: The same characteristic resistances can also be applied along supports at end-overlaps, if connection type "d" is not covered in the load table Annex C1

Hilti powder-actuated fastener X-ENP2K-20 L15 (MX)

Performances

Characteristic resistances per unit length for selected fastener patterns taking the effect of thermal constraints into account

Annex C2