

## HLD Light duty anchor

Anchor version	Benefits
 <p>HLD</p>	<ul style="list-style-type: none"> <li>- plastic undercut anchor</li> <li>- simple setting</li> <li>- esp. for drywall applications</li> </ul>

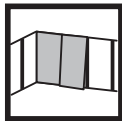

Drywall

### Basic loading data (for a single anchor)

#### All data in this section applies to

- Correct setting (See setting instruction)
- No edge distance and spacing influence
- Base material as specified in the table
- Load data given in the tables is independent of load direction

### Characteristic resistance

Anchor size				HLD 2	HLD 3	HLD 4
Anchoring principle <sup>a)</sup>						
Gypsum board Thickness 12,5mm	B	$F_{Rk}$	[kN]	0,4	0,4	0,4
Fibre reinforced gypsum board Thickness 12,5mm	A	$F_{Rk}$	[kN]	0,3	-	-
Fibre reinforced gypsum board Thickness 2x12,5mm	A	$F_{Rk}$	[kN]	-	0,6	-
Hollow clay brick	A / B	$F_{Rk}$	[kN]	0,75	0,75	
Concrete $\geq$ C16/20	C	$F_{Rk}$	[kN]	1,25	2	2,5

a) See setting details

## Design resistance

Anchor size			HLD 2	HLD 3	HLD 4
Anchoring principle <sup>a)</sup>					
Gypsum board Thickness 12,5mm	B	$F_{Rd}$ [kN]	0,11	0,11	0,11
Fibre reinforced gypsum board Thickness 12,5mm	A	$F_{Rd}$ [kN]	0,08	-	-
Fibre reinforced gypsum board Thickness 2x12,5mm	A	$F_{Rd}$ [kN]	-	0,17	-
Hollow clay brick	A / B	$F_{Rd}$ [kN]	0,21	0,21	-
Concrete $\geq$ C16/20	C	$F_{Rd}$ [kN]	0,35	0,56	0,70

a) See setting details

## Recommended loads <sup>b)</sup>

Anchor size			HLD 2	HLD 3	HLD 4
Anchoring principle <sup>a)</sup>					
Gypsum board Thickness 12,5mm	B	$F_{rec}$ [kN]	0,08	0,08	0,08
Fibre reinforced gypsum board Thickness 12,5mm	A	$F_{rec}$ [kN]	0,06	-	-
Fibre reinforced gypsum board Thickness 2x12,5mm	A	$F_{rec}$ [kN]	-	0,12	-
Hollow clay brick	A / B	$F_{rec}$ [kN]	0,15	0,15	-
Concrete $\geq$ C16/20	C	$F_{rec}$ [kN]	0,25	0,4	0,5

a) See setting details

b) With overall global safety factor  $\gamma = 5$  to the characteristic loads and a partial safety factor of  $\gamma = 1,4$  to the design values.

## Service temperature range

Hilti HLD light duty anchor may be applied in the temperature range given below.

Temperature range	Base material temperature	Maximum long term base material temperature	Maximum short term base material temperature
Temperature range	-40 °C to +80 °C	+50 °C	+80 °C

### Max short term base material temperature

Short-term elevated base material temperatures are those that occur over brief intervals, e.g. as a result of diurnal cycling.

### Max long term base material temperature

Long-term elevated base material temperatures are roughly constant over significant periods of time.

## Materials

### Material quality

Part	Material
Sleeve	Polyamide PA 6

## Setting

### Installation equipment

Anchor size	
Rotary hammer	TE 2 – TE 16
Other tools	Screwdriver

### Setting instruction

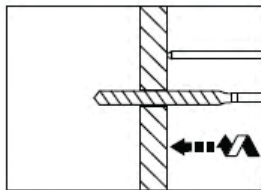

Drill hole with drill bit.

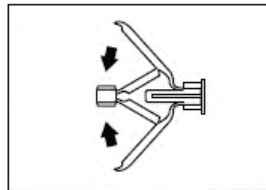

Install the HLD anchor.

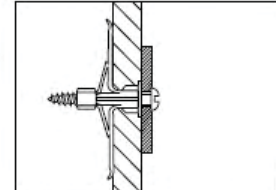
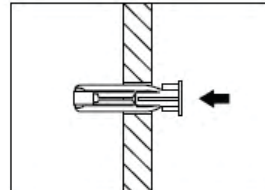

Drive in the screw.

For detailed information on installation see instruction for use given with the package of the product.

### Setting details and anchoring principles:

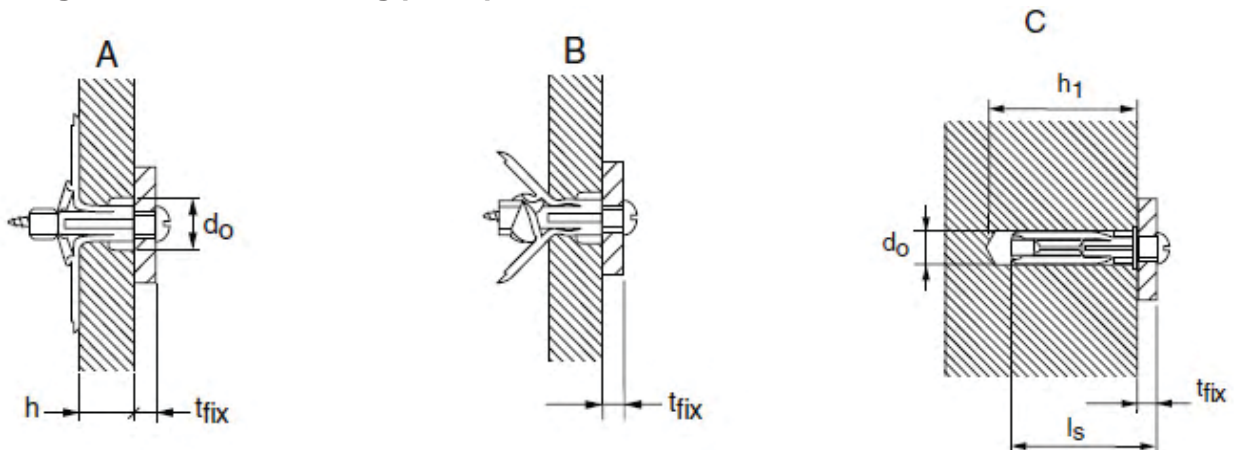

### Setting details HSP / HFP

Anchor version		HLD 2	HLD 3	HLD 4
Nominal diameter of drill bit	$d_o$ [mm]	10		
Depth of drill hole	(only anchoring principle C) $h_1 \geq$ [mm]	50	56	66
Screw length	(anchoring principle A/B) $l_s$ [mm]	$33 + t_{fix}$	$40 + t_{fix}$	$49 + t_{fix}$
	(anchoring principle C) $l_s$ [mm]	$40 + t_{fix}$	$46 + t_{fix}$	$56 + t_{fix}$
Screw diameter	(anchoring principle A/B) $d_s$ [mm]	4 – 5		
	(anchoring principle C) $d_s$ [mm]	5 – 6		
Wall / panel thickness	(anchoring principle A) $h$ [mm]	4 – 12	15 – 19	24 – 28
	(anchoring principle B) $h$ [mm]	12 – 16	19 – 25	28 – 32
	(anchoring principle C) $h \geq$ [mm]	35	42	50
Installation temperature	[°C]	-10 to +40		