

## HST Stud anchor

	Anchor version	Benefits
	HST Carbon steel	<ul style="list-style-type: none"> <li>- suitable for non-cracked and cracked concrete C 20/25 to C 50/60</li> <li>- quick and simple setting operation</li> <li>- safety wedge for certain follow up expansion</li> </ul>
	HST-R Stainless steel	
	HST-HCR High corrosion resistance steel	

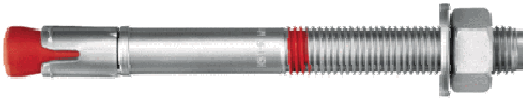

Concrete

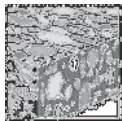

Tensile zone



Fire resistance



Shock



Seismic



Corrosion resistance



High corrosion resistance



European Technical Approval



CE conformity



### Approvals / certificates

Description	Authority / Laboratory	No. / date of issue
European technical approval <sup>a)</sup>	DIBt, Berlin	ETA-98/0001 / 2011-06-17
Shockproof fastenings in civil defence installations	Federal Office for Civil Protection, Bern	BZS D 08-602 / 2008-12-15
Fire test report	DIBt, Berlin	ETA-98/0001 / 2011-06-17
Fire test report ZTV-Tunnel	IBMB, Braunschweig	UB 3332/0881-2 / 2003-07-02
Assessment report (fire)	warringtonfire	WF 166402 / 2007-10-26

a) All data given in this section according ETA-98/0001, issue 2011-06-17.

### Basic loading data (for a single anchor)

All data in this section applies to

- Correct setting (See setting instruction)
- No edge distance and spacing influence
- Concrete as specified in the table
- **Steel** failure
- Minimum base material thickness
- Concrete C 20/25,  $f_{ck,cube} = 25 \text{ N/mm}^2$

For details see Simplified design method

**Mean ultimate resistance**

Anchor size	Non-cracked concrete						Cracked concrete					
	M8	M10	M12	M16	M20	M24	M8	M10	M12	M16	M20	M24
Tensile $N_{Ru,m}$												
HST [kN]	16,6	22,3	35,2	48,7	76,0	86,1	10,3	11,6	21,9	31,1	44,9	60,2
HST-R [kN]	18,1	26,7	35,1	49,8	77,4	79,1	12,7	18,4	20,1	36,0	55,1	70,5
HST-HCR [kN]	15,2	22,7	32,4	45,5	-	-	13,8	16,2	21,5	32,4	-	-
Shear $V_{Ru,m}$												
HST [kN]	17,6	27,8	40,5	67,8	102,9	112,3	17,6	27,8	40,5	67,8	102,9	112,3
HST-R [kN]	15,8	24,4	35,4	61,2	95,6	137,7	15,8	24,4	35,4	61,2	95,6	137,7
HST-HCR [kN]	17,6	27,8	40,5	75,4	-	-	17,6	27,8	40,5	75,4	-	-

**Characteristic resistance**

Anchor size	Non-cracked concrete						Cracked concrete					
	M8	M10	M12	M16	M20	M24	M8	M10	M12	M16	M20	M24
Tensile $N_{Rk}$												
HST [kN]	9,0	16,0	20,0	35,0	50,0	60,0	5,0	9,0	12,0	20,0	30,0	40,0
HST-R [kN]	9,0	16,0	20,0	35,0	50,0	60,0	5,0	9,0	12,0	25,0	30,0	40,0
HST-HCR [kN]	9,0	16,0	20,0	35,0	-	-	5,0	9,0	12,0	25,0	-	-
Shear $V_{Rk}$												
HST [kN]	14,0	23,5	35,0	55,0	84,0	94,0	14,0	23,5	35,0	55,0	84,0	94,0
HST-R [kN]	13,0	20,0	30,0	50,0	80,0	115,0	13,0	20,0	30,0	50,0	80,0	115,0
HST-HCR [kN]	13,0	20,0	30,0	55,0	-	-	13,0	20,0	30,0	53,5	-	-

**Design resistance**

Anchor size	Non-cracked concrete						Cracked concrete					
	M8	M10	M12	M16	M20	M24	M8	M10	M12	M16	M20	M24
Tensile $N_{Rd}$												
HST [kN]	5,0	10,7	13,3	23,3	33,3	40,0	2,8	6,0	8,0	13,3	20,0	26,7
HST-R [kN]	6,0	10,7	13,3	23,3	33,3	40,0	3,3	6,0	8,0	16,7	20,0	26,7
HST-HCR [kN]	6,0	10,7	13,3	23,3	-	-	3,3	6,0	8,0	16,7	-	-
Shear $V_{Rd}$												
HST [kN]	11,2	18,8	28,0	44,0	67,2	62,7	11,2	18,8	28,0	44,0	60,9	62,7
HST-R [kN]	10,4	16,0	24,0	38,5	55,6	79,9	10,4	16,0	24,0	35,6	55,6	79,9
HST-HCR [kN]	10,4	16,0	24,0	44,0	-	-	10,4	16,0	24,0	35,6	-	-

**Recommended loads**

Anchor size	Non-cracked concrete						Cracked concrete					
	M8	M10	M12	M16	M20	M24	M8	M10	M12	M16	M20	M24
Tensile $N_{rec}^{a)}$												
HST [kN]	3,6	7,6	9,5	16,7	23,8	28,6	2,0	4,3	5,7	9,5	14,3	19,0
HST-R [kN]	4,3	7,6	9,5	16,7	23,8	28,6	2,4	4,3	5,7	11,9	14,3	19,0
HST-HCR [kN]	4,3	7,6	9,5	16,7	-	-	2,4	4,3	5,7	11,9	-	-
Shear $V_{rec}^{a)}$												
HST [kN]	8,0	13,4	20,0	31,4	48,0	44,8	8,0	13,4	20,0	31,4	43,5	44,8
HST-R [kN]	7,4	11,4	17,1	27,5	39,7	57,0	7,4	11,4	17,1	25,5	39,7	57,0
HST-HCR [kN]	7,4	11,4	17,1	31,4	-	-	7,4	11,4	17,1	25,5	-	-

a) With overall partial safety factor for action  $\gamma = 1,4$ . The partial safety factors for action depend on the type of loading and shall be taken from national regulations.

## Materials

### Mechanical properties of HST, HST-R, HST-HCR

Anchor size		M8	M10	M12	M16	M20	M24
Nominal tensile strength $f_{uk}$	HST [N/mm <sup>2</sup> ]	800	800	800	720	700	530
	HST-R [N/mm <sup>2</sup> ]	720	700	700	650	650	650
	HST-HCR [N/mm <sup>2</sup> ]	800	800	800	800	-	-
Yield strength $f_{yk}$	HST [N/mm <sup>2</sup> ]	640	640	640	580	560	451
	HST-R [N/mm <sup>2</sup> ]	575	560	560	500	450	450
	HST-HCR [N/mm <sup>2</sup> ]	640	640	640	640	-	-
Stressed cross-section $A_s$	[mm <sup>2</sup> ]	36,6	58,0	84,3	157	245	353
Moment of resistance $W$	[mm <sup>3</sup> ]	31,2	62,3	109,2	277,5	540,9	935,5
Char. bending resistance $M_{Rk,s}^0$	HST [Nm]	30	60	105	240	454	595
	HST-R [Nm]	27	53	92	216	422	730
	HST-HCR [Nm]	30	60	105	266	-	-

### Material quality

Part	Material	
Bolt	HST	Carbon steel, galvanised to min. 5 $\mu$ m
	HST-R	Stainless steel
	HST-HCR	High corrosion resistant steel

## Anchor dimensions

Anchor size		M8	M10	M12	M16	M20	M24
Minimum thickness of fixture	$t_{fix,min}$ [mm]	2	2	2	2	2	2
Maximum thickness of fixture	$t_{fix,max}$ [mm]	195	200	200	235	305	330
Shaft diameter at the cone	$d_R$ [mm]	5,5	7,2	8,5	11,6	14,6	17,4
Minimum length of the anchor	$l_{1,min}$ [mm]	75	90	115	140	170	200
Maximum length of the anchor	$l_{1,max}$ [mm]	260	280	295	350	450	500
Length of expansion sleeve	$l_2$ [mm]	14,8	18,2	22,7	24,3	28,3	36

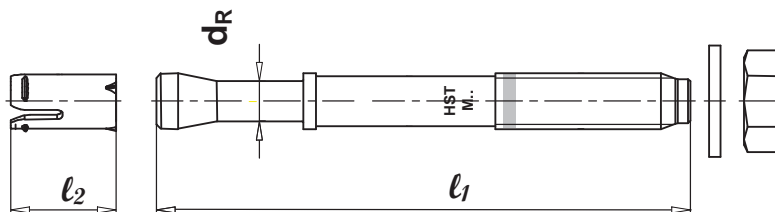

## Setting

### Installation equipment

Anchor size	M8	M10	M12	M16	M20	M24
Rotary hammer	TE2 – TE16				TE40 – TE70	
Other tools	hammer, torque wrench, blow out pump					

### Setting instruction

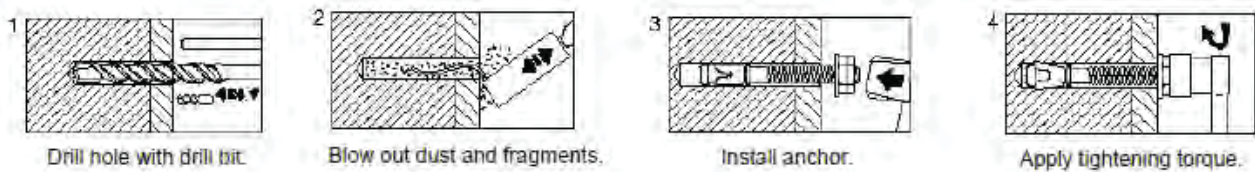

For detailed information on installation see instruction for use given with the package of the product.

For technical data for anchors in diamond drilled holes please contact the Hilti Technical advisory service.

### Setting details: depth of drill hole $h_1$ and effective anchorage depth $h_{ef}$

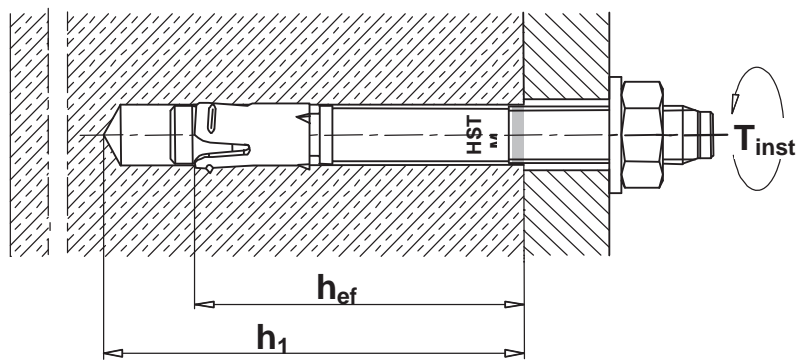

### Setting details HST, HST-R, HST-HCR

			M8	M10	M12	M16	M20	M24
Nominal diameter of drill bit	$d_o$	[mm]	8	10	12	16	20	24
Cutting diameter of drill bit	$d_{cut} \leq$	[mm]	8,45	10,45	12,5	16,5	20,55	24,55
Depth of drill hole	$h_1 \geq$	[mm]	65	80	95	115	140	170
Diameter of clearance hole in the fixture	$d_f \leq$	[mm]	9	12	14	18	22	26
Effective anchorage depth	$h_{ef}$	[mm]	47	60	70	82	101	125
Torque moment	$T_{inst}$	[Nm]	20	45	60	110	240	300
Width across	SW	[mm]	13	17	19	24	30	36

## Setting parameters

Anchor size			M8	M10	M12	M16	M20	M24
Minimum base material thickness	$h_{min}$	[mm]	100	120	140	160	200	250
Minimum spacing in non-cracked concrete	HST	$s_{min}$	60	55	60	70	100	125
		for $c \geq$	50	80	85	110	225	255
	HST-R	$s_{min}$	60	55	60	70	100	125
		for $c \geq$	60	70	80	110	195	205
	HST-HCR	$s_{min}$	60	55	60	70	-	-
		for $c \geq$	50	70	80	110	-	-
Minimum spacing in cracked concrete	HST	$s_{min}$	40	55	60	70	100	125
		for $c \geq$	50	70	75	100	160	180
	HST-R	$s_{min}$	40	55	60	70	100	125
		for $c \geq$	50	65	75	100	130	130
	HST-HCR	$s_{min}$	40	55	60	70	-	-
		for $c \geq$	50	70	75	100	-	-
Minimum edge distance in non-cracked concrete	HST	$c_{min}$	50	55	55	85	140	170
		for $s \geq$	60	115	145	150	270	295
	HST-R	$c_{min}$	60	50	55	70	140	150
		for $s \geq$	60	115	145	160	210	235
	HST-HCR	$c_{min}$	60	55	55	70	-	-
		for $s \geq$	60	115	145	160	-	-
Minimum edge distance in cracked concrete	HST	$c_{min}$	45	55	55	70	100	125
		for $s \geq$	50	90	120	150	225	240
	HST-R HST-HCR	$c_{min}$	45	50	55	60	100	125
		for $s \geq$	50	90	110	160	160	140
Critical spacing for splitting failure and concrete cone failure	$s_{cr,sp}$ $s_{cr,N}$	[mm]	141	180	210	246	303	375
Critical edge distance for splitting failure and concrete cone failure	$c_{cr,sp}$ $c_{cr,N}$	[mm]	71	90	105	123	152	188

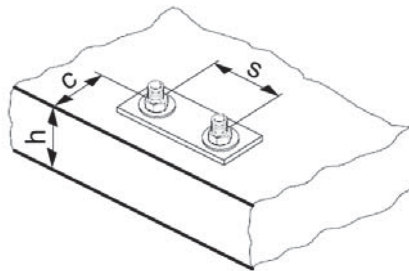

For spacing (edge distance) smaller than critical spacing (critical edge distance) the design loads have to be reduced.

## Simplified design method

Simplified version of the design method according ETAG 001, Annex C. Design resistance according data given in ETA-98/0001, issue 2011-06-17.

- Influence of concrete strength
- Influence of edge distance
- Influence of spacing
- Valid for a group of two anchors. (The method may also be applied for anchor groups with more than two anchors or more than one edge. The influencing factors must then be considered for each edge distance and spacing. The calculated design loads are then on the safe side: They will be lower than the exact

values according ETAG 001, Annex C. To avoid this, it is recommended to use the anchor design software PROFIS anchor)

The design method is based on the following simplification:

- No different loads are acting on individual anchors (no eccentricity)

The values are valid for one anchor.

For more complex fastening applications please use the anchor design software PROFIS Anchor.

### Tension loading

The design tensile resistance is the lower value of

- Steel resistance:  $N_{Rd,s}$
- Concrete pull-out resistance:  $N_{Rd,p} = N_{Rd,p}^0 \cdot f_B$
- Concrete cone resistance:  $N_{Rd,c} = N_{Rd,c}^0 \cdot f_B \cdot f_{1,N} \cdot f_{2,N} \cdot f_{3,N} \cdot f_{re,N}$
- Concrete splitting resistance (only non-cracked concrete):  
 $N_{Rd,sp} = N_{Rd,c}^0 \cdot f_B \cdot f_{1,sp} \cdot f_{2,sp} \cdot f_{3,sp} \cdot f_{h,sp} \cdot f_{re,N}$

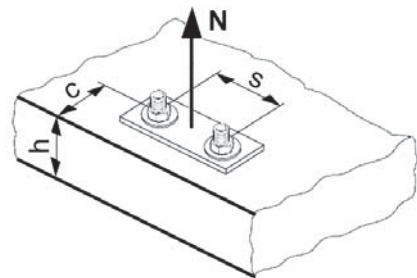

### Basic design tensile resistance

#### Design steel resistance $N_{Rd,s}$

Anchor size		M8	M10	M12	M16	M20	M24
$N_{Rd,s}$	HST [kN]	12,7	21,3	30,0	50,7	78,0	90,1
	HST-R [kN]	11,3	18,7	26,7	44,2	63,0	90,2
	HST-HCR [kN]	12,9	21,5	30,5	56,3	-	-

#### Design pull-out resistance $N_{Rd,p} = N_{Rd,p}^0 \cdot f_B$

Anchor size		Non-cracked concrete						Cracked concrete					
		M8	M10	M12	M16	M20	M24	M8	M10	M12	M16	M20	M24
$N_{Rd,p}^0$	HST [kN]	5,0	10,7	13,3	23,3	33,3	40,0	2,8	6,0	8,0	13,3	20,0	26,7
	HST-R [kN]	6,0	10,7	13,3	23,3	33,3	40,0	3,3	6,0	8,0	16,7	20,0	26,7
	HST-HCR [kN]	6,0	10,7	13,3	23,3	-	-	3,3	6,0	8,0	16,7	-	-

#### Design concrete cone resistance $N_{Rd,c} = N_{Rd,c}^0 \cdot f_B \cdot f_{1,N} \cdot f_{2,N} \cdot f_{3,N} \cdot f_{re,N}$

#### Design splitting resistance <sup>a)</sup> $N_{Rd,sp} = N_{Rd,c}^0 \cdot f_B \cdot f_{1,sp} \cdot f_{2,sp} \cdot f_{3,sp} \cdot f_{h,sp} \cdot f_{re,N}$

Anchor size		Non-cracked concrete						Cracked concrete					
		M8	M10	M12	M16	M20	M24	M8	M10	M12	M16	M20	M24
$N_{Rd,c}^0$	HST [kN]	9,0	15,6	19,7	24,9	34,1	47	6,4	11,2	14,1	17,8	24,4	33,5
	HST-R [kN]	10,8	15,6	19,7	24,9	34,1	47	7,7	11,2	14,1	17,8	24,4	33,5
	HST-HCR [kN]	10,8	15,6	19,7	24,9	-	-	7,7	11,2	14,1	17,8	-	-

a) Splitting resistance must only be considered for non-cracked concrete

## Influencing factors

### Influence of concrete strength

Concrete strength designation (ENV 206)	C 20/25	C 25/30	C 30/37	C 35/45	C 40/50	C 45/55	C 50/60
$f_B = (f_{ck,cube}/25N/mm^2)^{1/2}$ a)	1	1,1	1,22	1,34	1,41	1,48	1,55

a)  $f_{ck,cube}$  = concrete compressive strength, measured on cubes with 150 mm side length

### Influence of edge distance a)

$c/c_{cr,N}$	0,1	0,2	0,3	0,4	0,5	0,6	0,7	0,8	0,9	1
$c/c_{cr,sp}$										
$f_{1,N} = 0,7 + 0,3 \cdot c/c_{cr,N} \leq 1$	0,73	0,76	0,79	0,82	0,85	0,88	0,91	0,94	0,97	1
$f_{1,sp} = 0,7 + 0,3 \cdot c/c_{cr,sp} \leq 1$										
$f_{2,N} = 0,5 \cdot (1 + c/c_{cr,N}) \leq 1$	0,55	0,60	0,65	0,70	0,75	0,80	0,85	0,90	0,95	1
$f_{2,sp} = 0,5 \cdot (1 + c/c_{cr,sp}) \leq 1$										

a) The edge distance shall not be smaller than the minimum edge distance  $c_{min}$  given in the table with the setting details. These influencing factors must be considered for every edge distance.

### Influence of anchor spacing a)

$s/s_{cr,N}$	0,1	0,2	0,3	0,4	0,5	0,6	0,7	0,8	0,9	1
$s/s_{cr,sp}$										
$f_{3,N} = 0,5 \cdot (1 + s/s_{cr,N}) \leq 1$	0,55	0,60	0,65	0,70	0,75	0,80	0,85	0,90	0,95	1
$f_{3,sp} = 0,5 \cdot (1 + s/s_{cr,sp}) \leq 1$										

a) The anchor spacing shall not be smaller than the minimum anchor spacing  $s_{min}$  given in the table with the setting details. This influencing factor must be considered for every anchor spacing.

### Influence of base material thickness

$h/h_{ef}$	2,0	2,2	2,4	2,6	2,8	3,0	3,2	3,4	3,6	$\geq 3,68$
$f_{h,sp} = [h/(2 \cdot h_{ef})]^{2/3}$	1	1,07	1,13	1,19	1,25	1,31	1,37	1,42	1,48	1,5

### Influence of reinforcement

Anchor size	M8	M10	M12	M16	M20	M24
$f_{re,N} = 0,5 + h_{ef}/200mm \leq 1$	0,74 a)	0,8 a)	0,85 a)	0,91 a)	1	1

a) This factor applies only for dense reinforcement. If in the area of anchorage there is reinforcement with a spacing  $\geq 150$  mm (any diameter) or with a diameter  $\leq 10$  mm and a spacing  $\geq 100$  mm, then a factor  $f_{re,N} = 1$  may be applied.

## Shear loading

### The design shear resistance is the lower value of

- Steel resistance:  $V_{Rd,s}$
- Concrete pryout resistance:  $V_{Rd,cp} = k \cdot N_{Rd,c}$
- Concrete edge resistance:  $V_{Rd,c} = V_{Rd,c}^0 \cdot f_B \cdot f_{\beta} \cdot f_h \cdot f_4 \cdot f_{hef} \cdot f_c$

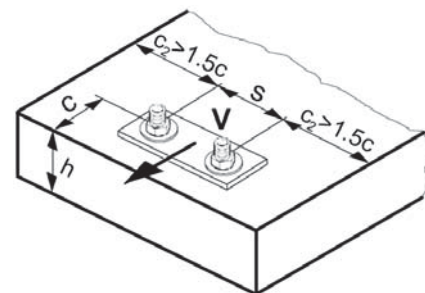

### Basic design shear resistance

#### Design steel resistance $V_{Rd,s}$

Anchor size		M8	M10	M12	M16	M20	M24
$V_{Rd,s}$	HST [kN]	11,2	18,8	28,0	44,0	67,2	62,7
	HST-R [kN]	10,4	16,0	24,0	38,5	55,6	79,9
	HST-HCR [kN]	10,4	16,0	24,0	44,0	-	-

#### Design concrete pryout resistance $V_{Rd,cp} = k \cdot N_{Rd,c}$ <sup>a)</sup>

Anchor size	M8	M10	M12	M16	M20	M24
k	2	2	2,2	2,5	2,5	2,5

a)  $N_{Rd,c}$ : Design concrete cone resistance

#### Design concrete edge resistance <sup>a)</sup> $V_{Rd,c} = V_{Rd,c}^0 \cdot f_B \cdot f_{\beta} \cdot f_h \cdot f_4 \cdot f_{hef} \cdot f_c$

Anchor size	Non-cracked concrete						Cracked concrete					
	M8	M10	M12	M16	M20	M24	M8	M10	M12	M16	M20	M24
$V_{Rd,c}^0$ [kN]	5,9	8,6	11,7	18,9	27,3	37,1	4,2	6,1	8,3	13,4	19,3	26,3

a) For anchor groups only the anchors close to the edge must be considered.

### Influencing factors

#### Influence of concrete strength

Concrete strength designation (ENV 206)	C 20/25	C 25/30	C 30/37	C 35/45	C 40/50	C 45/55	C 50/60
$f_B = (f_{ck,cube}/25N/mm^2)^{1/2}$ <sup>a)</sup>	1	1,1	1,22	1,34	1,41	1,48	1,55

a)  $f_{ck,cube}$  = concrete compressive strength, measured on cubes with 150 mm side length

#### Influence of angle between load applied and the direction perpendicular to the free edge

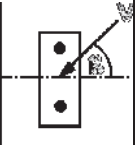
Angle $\beta$	0°	10°	20°	30°	40°	50°	60°	70°	80°	≥ 90°
$f_{\beta} = \frac{1}{\sqrt{(\cos \alpha_v)^2 + \left(\frac{\sin \alpha_v}{2,5}\right)^2}}$ 	1	1,01	1,05	1,13	1,24	1,40	1,64	1,97	2,32	2,50

#### Influence of base material thickness

h/c	0,15	0,3	0,45	0,6	0,75	0,9	1,05	1,2	1,35	≥ 1,5
$f_h = \{h/(1,5 \cdot c)\}^{1/2} \leq 1$	0,32	0,45	0,55	0,63	0,71	0,77	0,84	0,89	0,95	1,00



Influence of anchor spacing and edge distance <sup>a)</sup> for concrete edge resistance:  $f_4$

$$f_4 = (c/h_{ef})^{1,5} \cdot (1 + s / [3 \cdot c]) \cdot 0,5$$

c/h <sub>ef</sub>	Single anchor	Group of two anchors s/h <sub>ef</sub>														
		0,75	1,50	2,25	3,00	3,75	4,50	5,25	6,00	6,75	7,50	8,25	9,00	9,75	10,50	11,25
0,50	0,35	0,27	0,35	0,35	0,35	0,35	0,35	0,35	0,35	0,35	0,35	0,35	0,35	0,35	0,35	0,35
0,75	0,65	0,43	0,54	0,65	0,65	0,65	0,65	0,65	0,65	0,65	0,65	0,65	0,65	0,65	0,65	0,65
1,00	1,00	0,63	0,75	0,88	1,00	1,00	1,00	1,00	1,00	1,00	1,00	1,00	1,00	1,00	1,00	1,00
1,25	1,40	0,84	0,98	1,12	1,26	1,40	1,40	1,40	1,40	1,40	1,40	1,40	1,40	1,40	1,40	1,40
1,50	1,84	1,07	1,22	1,38	1,53	1,68	1,84	1,84	1,84	1,84	1,84	1,84	1,84	1,84	1,84	1,84
1,75	2,32	1,32	1,49	1,65	1,82	1,98	2,15	2,32	2,32	2,32	2,32	2,32	2,32	2,32	2,32	2,32
2,00	2,83	1,59	1,77	1,94	2,12	2,30	2,47	2,65	2,83	2,83	2,83	2,83	2,83	2,83	2,83	2,83
2,25	3,38	1,88	2,06	2,25	2,44	2,63	2,81	3,00	3,19	3,38	3,38	3,38	3,38	3,38	3,38	3,38
2,50	3,95	2,17	2,37	2,57	2,77	2,96	3,16	3,36	3,56	3,76	3,95	3,95	3,95	3,95	3,95	3,95
2,75	4,56	2,49	2,69	2,90	3,11	3,32	3,52	3,73	3,94	4,15	4,35	4,56	4,56	4,56	4,56	4,56
3,00	5,20	2,81	3,03	3,25	3,46	3,68	3,90	4,11	4,33	4,55	4,76	4,98	5,20	5,20	5,20	5,20
3,25	5,86	3,15	3,38	3,61	3,83	4,06	4,28	4,51	4,73	4,96	5,18	5,41	5,63	5,86	5,86	5,86
3,50	6,55	3,51	3,74	3,98	4,21	4,44	4,68	4,91	5,14	5,38	5,61	5,85	6,08	6,31	6,55	6,55
3,75	7,26	3,87	4,12	4,36	4,60	4,84	5,08	5,33	5,57	5,81	6,05	6,29	6,54	6,78	7,02	7,26
4,00	8,00	4,25	4,50	4,75	5,00	5,25	5,50	5,75	6,00	6,25	6,50	6,75	7,00	7,25	7,50	7,75
4,25	8,76	4,64	4,90	5,15	5,41	5,67	5,93	6,18	6,44	6,70	6,96	7,22	7,47	7,73	7,99	8,25
4,50	9,55	5,04	5,30	5,57	5,83	6,10	6,36	6,63	6,89	7,16	7,42	7,69	7,95	8,22	8,49	8,75
4,75	10,35	5,45	5,72	5,99	6,27	6,54	6,81	7,08	7,36	7,63	7,90	8,17	8,45	8,72	8,99	9,26
5,00	11,18	5,87	6,15	6,43	6,71	6,99	7,27	7,55	7,83	8,11	8,39	8,66	8,94	9,22	9,50	9,78
5,25	12,03	6,30	6,59	6,87	7,16	7,45	7,73	8,02	8,31	8,59	8,88	9,17	9,45	9,74	10,02	10,31
5,50	12,90	6,74	7,04	7,33	7,62	7,92	8,21	8,50	8,79	9,09	9,38	9,67	9,97	10,26	10,55	10,85

a) The anchor spacing and the edge distance shall not be smaller than the minimum anchor spacing  $s_{min}$  and the minimum edge distance  $c_{min}$ .

### Influence of embedment depth

Anchor size	M8	M10	M12	M16	M20	M24
$f_{hef} = 0,05 \cdot (h_{ef} / d)^{1,68}$	0,98	1,01	0,97	0,78	0,76	0,80

### Influence of edge distance <sup>a)</sup>

c/d	4	6	8	10	15	20	30	40
$f_c = (d / c)^{0,19}$	0,77	0,71	0,67	0,65	0,60	0,57	0,52	0,50

a) The edge distance shall not be smaller than the minimum edge distance  $c_{min}$ .

## Combined tension and shear loading

For combined tension and shear loading see section "Anchor Design".

### Precalculated values

Design resistance calculated according ETAG 001, Annex C and data given in ETA-98/0001, issue 2011-06-17. All data applies to concrete C 20/25 –  $f_{ck,cube} = 25 \text{ N/mm}^2$ .

Recommended loads can be calculated by dividing the design resistance by an overall partial safety factor for action  $\gamma = 1,4$ . The partial safety factors for action depend on the type of loading and shall be taken from national regulations.

### Design resistance

#### Single anchor, no edge effects

Anchor size			Non-cracked concrete						Cracked concrete					
			M8	M10	M12	M16	M20	M24	M8	M10	M12	M16	M20	M24
Min. base material thickness $h_{min}$ [mm]			100	120	140	160	200	250	100	120	140	160	200	250
	Tensile $N_{Rd}$													
	HST	[kN]	5,0	10,7	13,3	23,3	33,3	40,0	2,8	6,0	8,0	13,3	20,0	26,7
	HST-R	[kN]	6,0	10,7	13,3	23,3	33,3	40,0	3,3	6,0	8,0	16,7	20,0	26,7
	HST-HCR	[kN]	6,0	10,7	13,3	23,3	-	-	3,3	6,0	8,0	16,7	-	-
	Shear $V_{Rd}$ , without lever arm													
	HST	[kN]	11,2	18,8	28,0	44,0	67,2	62,7	11,2	18,8	28,0	44,0	60,9	62,7
	HST-R	[kN]	10,4	16,0	24,0	38,5	55,6	79,9	10,4	16,0	24,0	38,5	55,6	79,9
	HST-HCR	[kN]	10,4	16,0	24,0	44,0	-	-	10,4	16,0	24,0	44,0	-	-

#### Single anchor, min. edge distance ( $c = c_{min}$ )

Anchor size			Non-cracked concrete						Cracked concrete					
			M8	M10	M12	M16	M20	M24	M8	M10	M12	M16	M20	M24
Min. base material thickness $h_{min}$ [mm]			100	120	140	160	200	250	100	120	140	160	200	250
Min. edge distance $c_{min}$	HST	[mm]	50	55	55	85	140	170	45	55	55	70	100	125
	HST-R	[mm]	60	50	55	70	140	150	45	50	55	60	100	125
	HST-HCR	[mm]	60	55	55	70	-	-	45	50	55	60	-	-
	Tensile $N_{Rd}$													
	HST	[kN]	5,0	10,7	12,9	19,1	32,1	40,0	2,8	6,0	8,0	12,2	18,2	25,2
	HST-R	[kN]	6,0	10,5	12,9	17,0	32,1	39,7	3,3	6,0	8,0	11,2	18,2	25,2
	HST-HCR	[kN]	6,0	10,7	12,9	17,0	-	-	3,3	6,0	8,0	11,2	-	-
	Shear $V_{Rd}$ , without lever arm													
	HST	[kN]	4,5	5,6	5,9	11,3	22,8	32,0	2,8	3,9	4,2	6,2	10,7	15,4
	HST-R	[kN]	5,8	4,9	5,9	8,8	22,8	27,5	2,8	3,5	4,2	5,1	10,7	15,4
	HST-HCR	[kN]	5,8	5,6	5,9	8,8	-	-	2,8	3,5	4,2	5,1	-	-

#### Double anchor, no edge effects, min. spacing ( $s = s_{min}$ ), (load values are valid for one anchor)

Anchor size			Non-cracked concrete						Cracked concrete					
			M8	M10	M12	M16	M20	M24	M8	M10	M12	M16	M20	M24
Min. base material thickness $h_{min}$ [mm]			100	120	140	160	200	250	100	120	140	160	200	250
Min. spacing $s_{min}$ [mm]			60	55	60	70	100	125	40	55	60	70	100	125
	Tensile $N_{Rd}$													
	HST	[kN]	5,0	10,2	12,7	16,0	22,7	31,3	2,8	6,0	8,0	11,4	16,2	22,4
	HST-R	[kN]	6,0	10,2	12,7	16,0	22,7	31,3	3,3	6,0	8,0	11,4	16,2	22,4
	HST-HCR	[kN]	6,0	10,2	12,7	16,0	-	-	3,3	6,0	8,0	11,4	-	-
	Shear $V_{Rd}$ , without lever arm													
	HST	[kN]	11,2	18,8	27,8	40,1	56,7	62,7	8,3	14,6	19,9	22,9	40,5	55,9
	HST-R	[kN]	10,4	16,0	24,0	38,5	55,6	78,4	9,9	14,6	19,9	28,6	40,5	55,9
	HST-HCR	[kN]	10,4	16,0	24,0	40,1	-	-	9,9	14,6	19,9	28,6	-	-