



Foreword

Dear customer,

As it is our ambition to be the worldwide leader in fastening technology, we are continuously striving to provide you with state-of-the-art technical information reflecting the latest developments in codes, regulations and approvals and technical information for our products.

The Fastening Technology Manuals for Post-installed Anchors and for Anchor Channel reflect our ongoing investment into long term research and development of leading fastening products.

This Fastening Technology Manual for Post-installed Anchors should be a valuable support tool for you when solving fastening tasks with Post-installed Anchor fastening technology. It should provide you with profound technical know-how, and help you to be more productive in your daily work without any compromise regarding reliability and safety.

As we strive to be a reliable partner for you, we would very much appreciate your feedback for improvements. We are available at any time to answer additional questions that even go beyond this content.

Raimund Zaggl

Business Unit Anchors

Important notices

1. Construction materials and conditions vary on different sites. If it is suspected that the base material has insufficient strength to achieve a suitable fastening, contact the Hilti Technical Advisory Service.
2. The information and recommendations given herein are based on the principles, formulae and safety factors set out in the Hilti technical instructions, the operating manuals, the setting instructions, the installation manuals and other data sheets that are believed to be correct at the time of writing. The data and values are based on the respective average values obtained from tests under laboratory or other controlled conditions. It is the users responsibility to use the data given in the light of conditions on site and taking into account the intended use of the products concerned. The user has to check the listed prerequisites and criteria conform with the conditions actually existing on the job-site. Whilst Hilti can give general guidance and advice, the nature of Hilti products means that the ultimate responsibility for selecting the right product for a particular application must lie with the customer.
3. All products must be used, handled and applied strictly in accordance with all current instructions for use published by Hilti, i.e. technical instructions, operating manuals, setting instructions, installation manuals and others.
4. All products are supplied and advice is given subject to the Hilti terms of business.
5. Hilti's policy is one of continuous development. We therefore reserve the right to alter specifications, etc. without notice.
6. The given mean ultimate loads and characteristic data in the Anchor Fastening Technology Manual reflect actual test results and are thus valid only for the indicated test conditions. Due to variations in local base materials, on-site testing is required to determine performance at any specific site.
7. Hilti is not obligated for direct, indirect, incidental or consequential damages, losses or expenses in connection with, or by reason of, the use of, or inability to use the products for any purpose. Implied warranties of merchantability or fitness for a particular purpose are specifically excluded.

Hilti Corporation
FL-9494 Schaan
Principality of Liechtenstein
www.hilti.com

Hilti = registred trademark of the Hilti Corporation, Schaan

Anchor technology and design

Anchor selector
Legal environment
Base Material
Anchor design
Design examples
Dynamic loads (seismic, fatigue, shock)
Resistance to fire
Corrosion
Hilti SAFEset

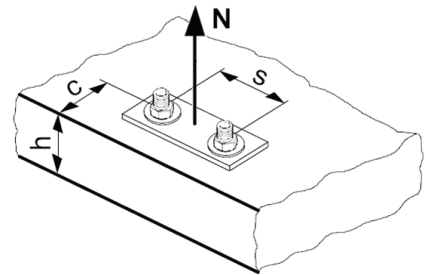

Mechanical anchoring systems

Heavy duty anchors
Medium duty anchors
Light duty anchors
Insulation fasteners



Adhesive anchoring systems

Adhesive capsule systems
Injection mortar systems



Post-installed rebar connections

Basics, design and installation
Injection mortar systems for post-installed rebars

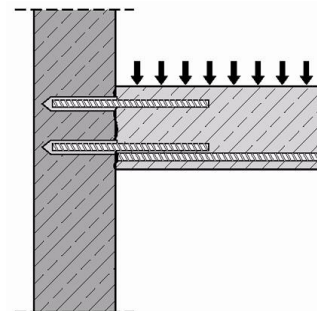

Rail anchoring systems

Introduction
Bottom-up – post-installed method
Top-down – cast-in method



Contents

Anchor technology and design	7
Anchor selector	8
Legal environment	22
Base material	26
Anchor design	32
Design example	42
Dynamic loads (seismic, fatigue, shock)	46
Resistance to fire	52
Corrosion	64
Hilti SAFEset	72
Mechanical anchoring systems	75
AM Heavy duty	
HSL-3 Heavy duty anchor, carbon steel	76
HSL-GR Heavy duty anchor, stainless steel	88
HDA Design anchor	98
HMU-PF Undercut anchor	114
HSC-A Safety anchor	128
HSC-I Safety anchor	138
AM Medium duty	
HST Stud anchor	148
HSA Stud anchor	162
HSA-F Stud anchor	182
HSV Stud anchor	196
HLC Sleeve anchor	206
HLV Sleeve anchor	212
HAM Hard sleeve anchor	216
HUS3 Screw anchor	218
HUS-HR, CR Screw anchor, stainless steel	252
HUS-V Screw anchor	272
HUS Screw anchor, carbon steel	288
HUS 6 Screw anchor, Redundant fastening	304
HUS-A 6 / HUS-H 6 / HUS-I 6 / HUS-P 6 Screw anchor in precast prestressed hollow core slabs	312
HUS 6 / HUS-S 6 Screw anchor	318
HKD Push-in anchor, Single anchor application	324
HKD Push-in anchor, Redundant fastening	338
HKV Push-in anchor, Single anchor application	346
AM Light duty	
HUD-1 Universal anchor	350
HUD-L Universal anchor	356
HLD Light duty anchor	360
HRD-U 10 / - S 10 / -U 14 Frame anchor	364
HRD Frame anchor, Redundant fastening	370
HRV Frame anchor	388
GD 14 + GRS 12 Scaffolding anchor	396
HPS-1 Impact anchor	400
HHD-S Cavity anchor	404
HCA Coil anchor	406
HSP / HFP Drywall plug	412
HA 8 Ring / hook anchor	414
DBZ Wedge anchor	418
HT Metal frame anchor	422
HK Ceiling anchor	426
HPD Aerated concrete anchor	432
HKH Hollow deck anchor	438
HTB Hollow wall metal anchor	442

AM Insulation fasteners

HIF Insulation fastener	446
IDP Insulation fastener	450
IZ Insulation fastener	454
IDMS / IDMR Insulation fastener	458

Adhesive anchoring systems463

AC Capsule systems

HVZ (HVU-TZ + HAS-TZ) adhesive anchor system	464
HVU with HAS/HAS-E rod adhesive anchor system	476
HVU with HIS-(R)N sleeve adhesive anchor system	486

AC Injectable mortars

Hilti HIT-RE 500-SD mortar with HIT-V rod	496
Hilti HIT-RE 500-SD mortar with HIS-(R)N sleeve	516
Hilti HIT-RE 500-SD mortar with rebar (as anchor)	530
Hilti HIT-RE 500-SD mortar with HIT-CS(-F) rod	546
Hilti HIT-RE 500 mortar with HIT-V / HAS rod	556
Hilti HIT-RE 500 mortar with HIS-(R)N sleeve	576
Hilti HIT-RE 500 mortar with rebar (as anchor)	592
Hilti HIT-HY 200 mortar with HIT-Z rod	610
Hilti HIT-HY 200 mortar with HIT-V rod	632
Hilti HIT-HY 200 mortar with HIS-(R)N sleeve	652
Hilti HIT-HY 200 mortar with rebar (as anchor)	668
Hilti HIT-HY 110 mortar with HIT-V / HAS rod	686
Hilti HIT-HY 110 mortar with HIS-(R)N sleeve	700
Hilti HIT-HY 110 mortar with rebar (as anchor)	712
Hilti HIT-HY 100 mortar with HIT-V rod	726
Hilti HIT-HY 100 mortar with HIS-(R)N sleeve	744
Hilti HIT-HY 100 mortar with rebar (as anchor)	756
Hilti HIT-HY 70 mortar for masonry	772
Hilti HIT-CT 1 mortar with HIT-V rod	798
Hilti HIT-ICE mortar with HIT-V / HAS rod	818
Hilti HIT-ICE mortar with HIS-(R)N sleeve	830
Hilti HIT-ICE mortar with rebar (as anchor)	842

Post-installed rebar connections853

Basics, design and installation of post installed rebars	854
Hilti HIT-RE 500-SD mortar with rebar (as post-installed connection)	892
Hilti HIT-RE 500 mortar with rebar (as post-installed connection)	908
Hilti HIT-HY 200 mortar with rebar (as post-installed connection)	922
Hilti HIT-HY 110 mortar with rebar (as post-installed connection)	930
Hilti HIT-HY 100 mortar with rebar (as post-installed connection)	938
Hilti HIT-CT 1 mortar with rebar (as post-installed connection)	946

Rail anchoring systems955

Introduction to Hilti rail anchoring systems	956
HRT-WH Rail anchor with Hilti HVU or Hilti HIT-RE 500	962
HRT Rail anchor with Hilti HIT-RE 500	966
HRC / HRC-DB Rail anchor with Hilti HIT-RE 500	970
HRA Rail anchor with Hilti HIT-RE 500 or HVU-G/EA glass capsule	974
HRT-I Rail anchor with Hilti HIT-RE 500	978
HRT-IP Rail Anchor for cast-in/top down construction method	982

Hilti worldwide986

Anchor technology and design

Anchor selector

Legal environment

Base Material

Anchor design

Design examples

Dynamic loads (seismic, fatigue, shock)







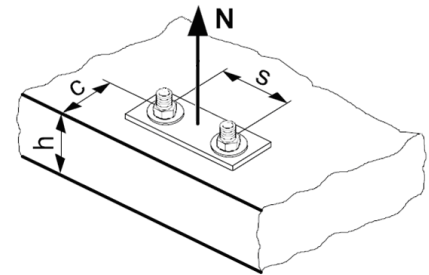

Resistance to fire

Corrosion

Hilti SAFEset



Anchor selector

Anchor type	Base material							Approvals					Application	
	Cracked concrete	Uncracked concrete	Lightweight concrete	Aerated concrete	Solid brick masonry	Hollow brick masonry	Pre-stressed concrete hollow deck	European Technical Approval	Seismic approval	Fatigue approval or test report	Shock approval	Fire tested		
Mechanical anchor systems														
Heavy duty anchors														
HSL-3 heavy duty anchor 	•	•						•	•	•	•	•	Fastening heavy loads e.g. from columns, high racks, machines	
HSL-GR heavy duty anchor 		•											Fastening heavy loads	
HDA-T/ -TR/TF/-P/-PR/-PF undercut anchor 	•	•						•	•	•	•	•	Anchor fastening for high loads e.g. in steel construction and plant construction	
HMU-PF Undercut anchor 	•	•						•	•	•	•	•	Fastening heavy loads	
HSC-A(R) /-I(R) safety anchor 	•	•						•				•	Safety relevant fastening at facades and ceilings where short embedment depth is required	
Medium duty anchors														
HST/-R/-HCR stud anchor 	•	•						•	•			•	•	Fastening through in place parts e.g. angles, tracks, channels, wooden beams, etc.
HSA/-R/-R2/-F stud anchor 		•						•					•	Fastening through in place parts like wooden beams, metal sections, columns, brackets, etc.
HSV stud anchor 		•												Fastening through in place parts









• = very suitable

○ = may be suitable per application

● = technical report



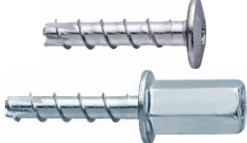







1) redundant fastening

Advantages	Drill bit diameter resp. anchor size	Specification						Setting		Page	
		Steel, galvanised	Steel, sheradised, hot dipped galv.	Stainless steel A2 (1.4303)	Stainless steel A4 (1.4401)	HCR steel (1.4529)	External thread	Internal thread	Pre-setting		Through-fastening
<ul style="list-style-type: none"> Integrated plastic section to telescope and pull down tightly The bolt can be retorqued 	Drill bit dia.: 12 – 32 mm Anchor size: M8 – M24	•					•		•	76	
<ul style="list-style-type: none"> Integrated plastic section to telescope and pull down tightly The bolt can be retorqued 	Drill bit dia.: 12 – 28 mm Anchor size: M8 – M20				•					88	
<ul style="list-style-type: none"> Automatic undercutting High load capacity Approved for all dynamic loads 	Drill bit dia.: 20 – 37 mm Anchor size: M10 – M20	•	•		•		•		•	98	
<ul style="list-style-type: none"> Reliable mechanical interlock Easy verification of correct setting due to red setting mark 	Drill bit dia.: 18 – 22 mm Anchor size: M12 – M16		•				•		•	114	
<ul style="list-style-type: none"> Automatic undercutting Small edge distances and spacings Small setting depth 	Drill bit dia.: 14 – 20 mm Anchor size: M6 – M12	•			•		•	•	•	128 138	
<ul style="list-style-type: none"> Quick and simple setting operation Setting mark Safety wedge for certain follow up expansion 	Drill bit dia.: 8 – 24 mm Anchor size: M8 – M24	•			•	•	•		•	•	148
<ul style="list-style-type: none"> Three setting depths Setting mark Extremely ductile steel for high bending capacity 	Drill bit dia.: 6 – 20 mm Anchor size: M6 – M20	•	•		•		•		•	•	162 182
<ul style="list-style-type: none"> Quick and simple setting operation 	Drill bit dia.: 8 – 16 mm Anchor size: M8 – M16	•					•		•	•	196

Anchor type	Base material						Approval					Application	
	Cracked concrete	Uncracked concrete	Lightweight concrete	Aerated concrete	Solid brick masonry	Hollow brick masonry	Pre-stressed concrete hollow deck	European Technical Approval	Seismic approval	Fatigue approval or test report	Shock approval		Fire tested
Medium duty anchors													
HLC sleeve anchor 		•			•							•	Suitable for a large range of temporary applications and fixing of small devices
HLV Sleeve anchor 		•											Light and medium-duty fastenings in concrete
HAM hard sleeve anchor 		•			•								Secure fastenings in various base materials
HUS3 screw anchor 	•	•		•	•	•		•	•			•	Fastening base plates, railings and handrailings, structural steel and temporary applications
HUS-HR CR screw anchor, stainless steel 	•	•		•	•			•	•			•	Fastening channels, railings, façade panels and tunnel construction
HUS-V screw anchor 	•	•											Fastening base plates, railings and handrailings and temporary applications
HUS- 6 screw anchor, redundant fastening 	• 1)	•		•	•		•	•				•	Fastening channels, brackets, racks, seating
HUS 6 / HUS-S 6 screw anchor 		•	•	•	•	•						•	Fastening light channels, brackets, interior panelling or cladding











• = very suitable ◦ = may be suitable per application ● = technical report 1) redundant fastening

Advantages	Drill bit diameter resp. anchor size	Specification							Setting		Page	
		Steel, galvanised	Steel, sheradised, hot dipped galv.	Stainless steel A2 (1.4303)	Stainless steel A4 (1.4401)	HCR steel (1.4529)	External thread	Internal thread	Pre-setting	Through-fastening		
<ul style="list-style-type: none"> Different base materials Ideal for through applications 	Drill bit dia.: 6,5 – 20 mm Anchor size: M5 – M16	•						•		•	•	206
<ul style="list-style-type: none"> Available in a variety of sizes Pre-setting and through fastening configurations 	Drill bit dia.: 6,5 – 16 mm Anchor size: M5 – M12	•						•		•	•	212
<ul style="list-style-type: none"> Wings to prevent spinning in the bore hole Plastic cap in cone to prevent dust entrance 	Drill bit dia.: 12 – 20 mm Thread: M6 – M12	•							•	•		216
<ul style="list-style-type: none"> Screw driven straight into base material Higher productivity Approval for reusability in fresh concrete 	Drill bit dia.: 8 – 14 mm	•									•	218
<ul style="list-style-type: none"> Screw driven straight into base material Higher productivity 	Drill bit dia.: 6 – 14 mm				•						•	252
<ul style="list-style-type: none"> Approval for reusability in fresh concrete 	Drill bit dia.: 8 – 10 mm											272
<ul style="list-style-type: none"> Screw driven straight into base material Forged on washer Matched system of screw anchor and screw driver 	Drill bit dia.: 6 mm	•							•		•	304
<ul style="list-style-type: none"> Screw driven straight into base material Small drill bit diameter Matched system of screw anchor and screw driver 	Drill bit dia.: 6 mm	•									•	318

Anchor type	Base material							Approvals					Application	
	Cracked concrete	Uncracked concrete	Lightweight concrete	Aerated concrete	Solid brick masonry	Hollow brick masonry	Dry wall	Pre-stressed concrete hollow deck	European Technical Approval	Seismic approval	Fatigue approval or test report	Shock approval		Fire tested
Medium duty anchors														
HKD push-in anchor 	•	•							•				•	Fastening with threaded rods for pipe suspensions, air ducts, suspended ceilings
HKV push-in anchor 		•												Fastening with threaded rods for pipe suspensions, air ducts, suspended ceilings
Light duty anchors														
HUD-1 universal anchor 		•	•	•	•	•	•							Light duty applications such as pipe clamps, electrical boxes, sanitary fixtures, etc.
HUD-L universal anchor 		•	•	•	•	•	•							Light duty applications such as pipe clamps, electrical boxes sanitary fixtures, etc.
HLD light duty anchor 		•				•	•	○						Fastenings to weak material with cavities
HRD-U/-S frame anchor 		•	•	•	•	•			•					• Securing support frames, timber frames, facade panels, curtain walling
HRD frame anchor 	•	•	•	•	•	•		•	•					• Universal frame anchor for facade panels, curtain walls and other applications
HRV Frame anchor 		•	○	○	•	○								Fastening metal substructures for ventilated facades
GD 14 + GRS Scaffolding anchor 		•			•									Light duty scaffold tie for use with hooks
HPS-1 impact anchor 		•	○	•	•	•								Fastening wood battens, channel installations for dry wall fixings, components for electrical and plumbing installations





• = very suitable ○ = may be suitable per application ● = technical report 1) redundant fastening

Advantages	Drill bit diameter resp. anchor size	Specification							Setting		Page
		Steel, galvanised	Steel, sheradised, hot dipped galv.	Stainless steel A2 (1.4303)	Stainless steel A4 (1.4401)	HCR steel (1.4529)	External thread	Internal thread	Pre-setting	Through-fastening	
<ul style="list-style-type: none"> Visual verification of full expansion Small setting depth 	Drill bit dia.: 8 – 25 mm Anchor size: M6 – M20	•			•			•	•	324 338	
<ul style="list-style-type: none"> Visual verification of full expansion Small setting depth 	Drill bit dia.: 8 – 20 mm Anchor size: M6 – M16	•						•	•	346	
<ul style="list-style-type: none"> Fast setting Flexibility of screw length An anchor for every base material 	Drill bit dia.: 5 – 14 mm							•	•	350	
<ul style="list-style-type: none"> Fast setting Flexibility of screw length An anchor for every base material 	Drill bit dia.: 6 – 10 mm							•	•	356	
<ul style="list-style-type: none"> Flexibility of screw length Resilient toggling action to suit every base material 	Drill bit dia.: 10 mm							•		360	
<ul style="list-style-type: none"> Preassembled with screw Screw of steel strength 5.8 	Drill bit dia.: 10 and 14 mm	•							•	364	
<ul style="list-style-type: none"> Impact and temperature resistant high quality plastic 	Drill bit dia.: 8 – 10 mm	•	•	•	•				•	370	
<ul style="list-style-type: none"> Integrated plastic and steel washers 	Drill bit dia.: 10 mm	•	•						•	388	
<ul style="list-style-type: none"> Various lengths are available to suit specific requirements 	Drill bit dia.: 14 mm									396	
<ul style="list-style-type: none"> impact and temperature resistant high quality plastic 	4 – 8 mm	•		•					•	400	

Anchor type	Base material							Approvals					Application
	Cracked concrete	Uncracked concrete	Lightweight concrete	Aerated concrete	Solid brick masonry	Hollow brick masonry	Dry wall	Pre-stressed concrete hollow deck	European Technical Approval	Seismic approval	Fatigue approval or test report	Shock approval	
Light duty anchors													
HHD-S cavity anchor 						•	•						Fastening battens, channels panels
HCA coil anchor 		•											Temporary external fastenings
HSP/HFPdrywall plug 								•					Fastenings in dry walls
HA8 ring/ hook anchor 	• 1)	•										•	For suspended ceilings and other items from concrete ceilings
DBZ wedge anchor 	• 1)	•							•				• Suspension from concrete ceilings e.g. using steel straps, punched band, Nonius system hanger
HT metal frame anchor 		•	•	•	•	•							• Fastening door and window frames
HK ceiling anchor 	• 1)	•							•				• Fastening of suspended ceilings, cable trays, pipes
HPD aerated concrete anchor 				•									• Various fastenings
HKH hollow deck anchor 								•	•				• Suspension from pre-stressed concrete hollow decks
HTB 						•	•	•					Ingenious and strong for hollow base materials





• = very suitable ○ = may be suitable per application ● = technical report 1) redundant fastening

Advantages	Drill bit diameter resp. anchor size	Specification							Setting		Page
		Steel, galvanised	Steel, sheradised, hot dipped galv.	Stainless steel A2 (1.4303)	Stainless steel A4 (1.4401)	HCR steel (1.4529)	External thread	Internal thread	Pre-setting	Through-fastening	
<ul style="list-style-type: none"> Controlled setting Deliverable with or without prefitted screw 	Drill bit dia.: 8 – 10 mm	•						•	•		404
<ul style="list-style-type: none"> Re-usable up to 140 times Removable High load capacity 	Drill bit dia.: 16 mm										406
<ul style="list-style-type: none"> Self-drilling tip One bit for anchor and screw Removable 	-								•		412
<ul style="list-style-type: none"> Quick and easy setting Automatic follow up expansion 	Drill bit dia.: 8 mm	•							•		414
<ul style="list-style-type: none"> Small drill bit diameter Quick setting by impact extension Automatic follow up expansion 	Drill bit dia.: 6 mm	•								•	418
<ul style="list-style-type: none"> No risk of distortion or forces of constraint Expansion cone can not be lost 	Drill bit dia.: 8 – 10 mm	•								•	422
<ul style="list-style-type: none"> Small bore hole Quick and easy setting 	Drill bit dia.: 6 mm M6	•					•		•		426
<ul style="list-style-type: none"> Approved (DIBt) Fire resistance Immediately loadable 	Without predrilling Thread: M6 – M10	•					•		•		432
<ul style="list-style-type: none"> Approval for single point fastenings Approved for sprinkler systems 	Drill bit dia.: 10 – 14 mm Thread: M6 – M10	•					•		•	•	438
<ul style="list-style-type: none"> Load carried by strong metal channel and screw Convincing simplicity when setting 	Drill bit dia.: 13 – 14 mm								•		442

Anchor type	Base material							Approvals					Application
	Cracked concrete	Uncracked concrete	Lightweight concrete	Aerated concrete	Solid brick masonry	Hollow brick masonry	Dry wall	Pre-stressed concrete hollow deck	European Technical Approval	Seismic approval	Fatigue approval or test report	Shock approval	
Insulation fasteners													
HIF insulation fastener 		●	●	●	●	●							Fastening of insulating materials in different base materials
IDP insulation fastener 		●	●		●	●							Fastening of hard, self supporting insulating materials
IZ expandable insulation fastener 		●	●		●	●							Fastening of soft and hard, self supporting insulating materials
IDMS / IDMR insulation fastener 		●	●		●	●						●	Fastening of soft and hard, self supporting insulating materials and non self supporting insulation materials





● = very suitable ○ = may be suitable per application ● = technical report 1) redundant fastening

Advantages	Drill bit diameter resp. anchor size	Specification						Setting		Page
		Steel, galvanised	Steel, sheradised, hot dipped galv.	Stainless steel A2 (1.4303)	Stainless steel A4 (1.4401)	HCR steel (1.4529)	External thread	Internal thread	Pre-setting	
<ul style="list-style-type: none"> No additional plate needed, do not sink in soft insulation material Speed due to less drilling effort 	Drill bit dia.: 8 mm Mat. thickness up to 240mm								•	446
<ul style="list-style-type: none"> One piece element Corrosion resistant No heat bridge 	Drill bit dia.: 8 mm Mat. thickness up tp 150mm								•	450
<ul style="list-style-type: none"> Corrosion resistant No heat bridge Reliable bonding of plaster 	Drill bit dia.: 8 mm Mat. thickness up to 180mm								•	454
<ul style="list-style-type: none"> One piece element Corrosion resistant Fire resistant 	Drill bit dia.: 8 mm Mat. thickness up to 150mm	•		•					•	458

Anchor type	Base material						Approvals					Application	
	Cracked concrete	Uncracked concrete	Lightweight concrete	Aerated concrete	Solid brick masonry	Hollow brick masonry	Pre-stressed concrete hollow deck	European Technical Approval	Seismic approval	Fatigue approval or test report	Shock approval		Fire tested
Adhesive anchor systems													
Adhesive capsule systems													
HVZ adhesive anchor 	•	•						•		•	•	•	Heavy-duty fastenings with small spacing and edge distances
HVU adhesive anchor 		•						•					Heavy duty fastenings with small spacing and edge distances
Injection mortar systems													
HIT-RE 500-SD 	•	•						•	•			•	Adhesive anchor in cracked concrete
HIT-RE 500 		•						•				•	Adhesive anchor
HIT-HY 200 	•	•						•	•			•	Adhesive anchor in cracked concrete

• = very suitable ◦ = may be suitable per application • = technical report 1) redundant fastening

Advantages	Drill bit diameter resp. anchor size	Specification							Setting		Page
		Steel, galvanised	Steel, sheradised, hot dipped galv.	Stainless steel A2 (1.4303)	Stainless steel A4 (1.4401)	HCR steel (1.4529)	External thread	Internal thread	Pre-setting	Through-fastening	
<ul style="list-style-type: none"> No expansion pressure Small edge distances and spacing A strong and flexible foil capsule 	M10 – M20	•			•	•	•		•		464
<ul style="list-style-type: none"> No expansion pressure Small edge distances and spacing A strong and flexible foil capsule 	HAS M8 – M39 HIS-M8 - M20 Rebar dia. 8 – 40 mm	•			•	•	•	•	•		476 486
<ul style="list-style-type: none"> No expansion pressure Long working time SAFEset with hollow drill bit 	HIT-V M8 – M30 HIS-M8 - M20 Rebar dia. 8 – 32 mm	•			•	•	•	•	•		496 516 530 546 920(post)
<ul style="list-style-type: none"> No expansion pressure Long working time SAFEset with hollow drill bit 	HIT-V M8 – M39 HIS-M8 - M20 Rebar dia. 8 – 40 mm	•			•	•	•	•	•		556 576 592 936(post)
<ul style="list-style-type: none"> No expansion pressure Flexibility in terms of working time No styrene content No plasticizer content Environmental protection due to the minimized packaging SAFEset with hollow drill bit and HIT-Z rod 	HIT-V M8 – M30 HIS-Z M8 - M20 Rebar dia. 8 – 32 mm	•	•	•	•	•	•	•	•	•	610 632 652 668 950(post)

Anchor type	Base material							Approvals					Application
	Cracked concrete	Uncracked concrete	Lightweight concrete	Aerated concrete	Solid brick masonry	Hollow brick masonry	Pre-stressed concrete hollow deck	European Technical Approval	Seismic approval	Fatigue approval or test report	Shock approval	Fire tested	
Injection mortar systems													
HIT-HY 110 		●						●					Adhesive anchor for use in concrete
HIT-HY 100 	●	●						●					Adhesive anchor for use in concrete
HIT-HY 70 		●			●	●						●	Universal mortar for solid and hollow brick
HIT-CT 1 		●						●					Hilti Clean technology adhesive anchor
HIT ICE 		●											Adhesive anchor for low installation temperatures

● = very suitable ○ = may be suitable per application ● = technical report 1) redundant fastening

Advantages	Drill bit diameter resp. anchor size	Specification						Setting		Page
		Steel, galvanised	Steel, sheradised, hot dipped galv.	Stainless steel A2 (1.4303)	Stainless steel A4 (1.4401)	HCR steel (1.4529)	External thread	Internal thread	Pre-setting	
<ul style="list-style-type: none"> Suitable for dry and water saturated concrete Small edge distance and anchor spacing possible Variable embedment depth 	HIT-V M8 – M30 HIS-M8 - M20 Rebar dia. 8 – 25 mm	•	•		•	•	•	•	•	686 700 712 958(post)
<ul style="list-style-type: none"> Suitable for dry and water saturated concrete Small edge distance and anchor spacing possible Variable embedment depth 	HIT-V M8 – M30 HIS-M8 - M20 Rebar dia. 8 – 25 mm	•	•		•	•	•	•	•	726 744 756 966(post)
<ul style="list-style-type: none"> No expansion pressure mortar filling control with HIT-SC sleeves 	Drill bit dia.: 10 – 22 mm Thread: M6 – M12	•			•		•	•	•	772
<ul style="list-style-type: none"> No expansion pressure Environmentally and user friendly: clean of critical hazardous substances 	HIT-V M8 – M24	•	•		•	•	•			798 974(post)
<ul style="list-style-type: none"> No expansion pressure 	HAS M8 – M24 HIS-M8 - M20 Rebar dia. 8 – 25 mm	•	•		•	•	•	•	•	818 830 842

Legal environment

Technical data

The technical data presented in this Anchor Fastening Technology Manual are all based on numerous tests and evaluation according to the state-of-the art. Hilti anchors are tested in our test labs in Kaufering (Germany), Schaan (Liechtenstein) or Tulsa (USA) and evaluated by our experienced engineers and/or tested and evaluated by independent testing institutes in Europe and the USA.

Approval based data given in this manual are either according to **European Assessment Documents (EADs)** or **European Technical Approval Guidelines (ETAGs)** (that as of 1st of July 2013 are used as EADs or have been evaluated according to these guidelines and/or national regulations. Where national or international regulations do not cover all possible types of applications, additional Hilti data help to find customised solutions.

In addition to the standard tests for admissible service conditions and suitability tests (including seismic as an option), for safety relevant applications fire resistance, shock and fatigue tests may have been performed.

Basis for assessing anchors

European Technical Approval Guidelines have been developed prior to July 2013 for the assessment of products not covered by a harmonised standard.

The European Technical Approval Guideline **ETAG 001 „METAL ANCHORS FOR USE IN CONCRETE“** sets out the basis for assessing anchors to be used in concrete (cracked and non-cracked). It consists of:

- Part 1 Anchors in general
- Part 2 Torque-controlled expansion anchors
- Part 3 Undercut anchors
- Part 4 Deformation-controlled expansion anchors
- Part 5 Bonded anchors
- Part 6 Anchors for multiple use for non-structural applications
- Annex A Details of test
- Annex B Tests for admissible service conditions – detailed information
- Annex C Design methods for anchorages

For **special anchors** for use in concrete, additional Technical Reports (TR) related to ETAG 001 set out additional requirements for the assessment and/or provide a design method:

- **TR 018 Assessment of torque-controlled bonded anchors**
- **TR 020 Evaluation of Anchorages in Concrete concerning Resistance to Fire**
- **TR 029 Design of Bonded Anchors**

The European Technical Approval Guideline **ETAG 020 „PLASTIC ANCHORS FOR MULTIPLE USE IN CONCRETE AND MASONRY FOR NON-STRUCTURAL APPLICATIONS“** sets out the basis for assessing plastic anchors to be used in **concrete or masonry for redundant fastenings (multiple use)**. It consists of:

- Part 1 General
- Part 2 Plastic anchors for use in normal weight concrete
- Part 3 Plastic anchors for use in solid masonry materials
- Part 4 Plastic anchors for use in hollow or perforated masonry

- Part 5 Plastic anchors for use in autoclaved aerated concrete (AAC)
- Annex A Details of tests
- Annex B Recommendations for tests to be carried out on construction works
- Annex C Design methods for anchorages

The European Technical Approval Guidelines including related Technical Reports set out the requirements for anchors and the acceptance criteria they shall meet.

The general assessment approach adopted in the Guideline is based on combining relevant existing knowledge and experience of anchor behaviour with testing. Using this approach, testing is needed to assess the suitability of anchors.

The requirements in European Technical Approval Guidelines are set out in terms of objectives and of relevant actions to be taken into account. ETAGs specify values and characteristics, the conformity with which gives the presumption that the requirements set out are satisfied, whenever the state of art permits to do so. The Guidelines may indicate alternate possibilities for the demonstration of the satisfaction of the requirements.

Basis for assessing post-installed rebar connections

The basis for the assessment of **post-installed rebar connections** is set out in the following Technical Report:

- **TR 023 Assessment of post-installed rebar connections**

The Technical Report TR 023 covers post-installed rebar connections designed in accordance with EN 1992 - 1-1: 2004 (EC2) only. ETAG 001 (Part 1 and Part 5) is the general basis for the assessment of this application. The Technical Report TR 023 deals with the preconditions, assumptions and the required tests and assessments for post-installed rebars.

European Assessment Documents (from 1st of July 2013)

European Assessment Documents (EADs) are harmonised technical specifications, applicable as of 1st of July 2013 within the frame of the new Construction Products Regulation (EU/305/2011), developed by the European Organisation for Technical Assessment (EOTA).

The EADs contribute to the safe assessment of construction products, enables manufacturers to comply with European legislation, facilitates the uptake of innovation, research and technical development, and promotes the interoperability of products and sustainability. The EAD contains the following information:

- General information, scope and use of the products
- Essential characteristics of the products
- Method of assessment of the performance of the products
- Reference to the Assessment and Verification of Constancy of Performance (AVCP)
- Assumptions for the assessment of the performances
- Identification of the product
- Reference documents such as other EADs, standards, technical reports etc.
- Product related example for a Declaration of Performance (DoP)

As of 1st of July 2013 no new ETAGs will be developed. However, the **existing ETAGs can be used as EADs until they are transferred into new EADs.**

European Technical Assessment (previously European Technical Approval)

According to the new Construction Products Regulation (EU/305/2011), the European Technical Assessment (ETA) is a document that provides information on the assessment of the performance of product regarding its essential characteristics. An ETA is delivered by a Technical Assessment Body (TAB) upon request by a manufacturer and is the basis for a Declaration of Performance (DoP), which in turn is required for affixing the CE marking on the product.

Current ETAs issued after 1st of July 2013 are valid of indeterminate duration and contain the following information:

- General information on the manufacturer and the product type
- Description of the product and its intended use
- Performances of the product and references to the methods used for its assessment
- Assessment and Verification of Constancy of Performance systems (AVCP) applied
- Technical details necessary for the implementation of the AVCP

ETAs which were issued up to 30 June 2013, called European Technical Approvals and based on ETAGs, remain valid until the end of their validity period.

Declaration of performance (DoP)

The DoP is prepared by the manufacturer and presents the information about the performance of the product in relation to the essential characteristics. In drawing up the DoP, the manufacturer assumes the responsibility for the conformity of the construction product with the declared performance.

Assessment and Verification of Constancy of Performance (AVCP)

In order to ensure that the declaration of performance (DoP) for specific products is accurate and reliable, the performance of the construction products shall be assessed and their production in the factory shall be controlled to ensure that the products will continue to have the same performances.

This is achieved by applying a system of Assessment and Verification of Constancy of Performance (AVCP) for each family of construction product, for which several tasks have to be undertaken (e.g. for System 1+ and 1):

For the manufacturer:

- factory production control (permanent internal control of production and documentation according to a prescribed test plan)
- involve a body which is notified for the tasks

The notified product certification body decides on the issuing, restriction, suspension or withdrawal of the certificate of constancy of performance of the product on the basis of the outcome of the following assessments and verification carried out by the body:

- assessment of the performance of the product
- initial inspection of the manufacturing plant and of factory production control
- continuing surveillance, assessment and evaluation of factory production control

Base material

General

Different anchoring conditions

The wide variety of building materials used today provide different anchoring conditions for anchors. There is hardly a base material in or to which a fastening cannot be made with a Hilti product. However, the properties of the base material play a decisive role when selecting a suitable fastener / anchor and determining the load it can hold.

The main building materials suitable for anchor fastenings have been described in the following.

Concrete

A mixture of cement, aggregates and water

Concrete is synthetic stone, consisting of a mixture of cement, aggregates and water, possibly also additives, which is produced when the cement paste hardens and cures. Concrete has a relatively high compressive strength, but only low tensile strength. Steel reinforcing bars are cast in concrete to take up tensile forces. It is then referred to as reinforced concrete.

Cracking from bending

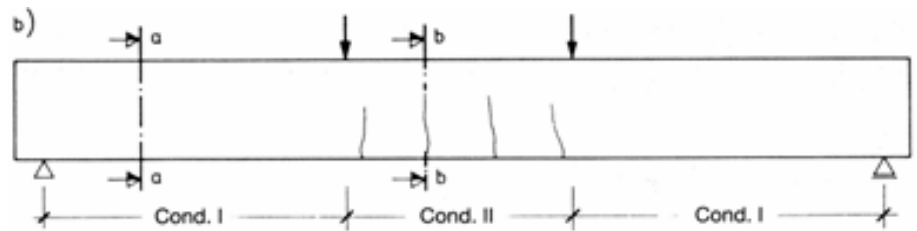

Stress and strain in sections with conditions I and II

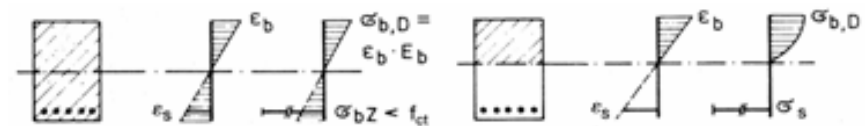

$\sigma_{b,D}$ calculated compressive stress
 $\sigma_{b,Z}$ calculated tensile stress
 f_{ct} concrete tensile strength

If cracks in the tension zone exist, suitable anchor systems are required

If the tensile strength of concrete is exceeded, cracks form, which, as a rule, cannot be seen. Experience has shown that the crack width does not exceed the figure regarded as admissible, i.e. $w \cong 0.3\text{mm}$, if the concrete is under a constant load. If it is subjected predominately to forces of constraint, individual cracks might be wider if no additional reinforcement is provided in the concrete to restrict the crack width. If a concrete component is subjected to a bending load, the cracks have a wedge shape across the component cross-section and they end close to the neutral axis. It is recommended that anchors that are suitable in cracked concrete be used in the tension zone of concrete components. Other types of anchors can be used if they are set in the compression zone.

Observe curing of concrete when using expansion anchors

Anchors are set in both low-strength and high-strength concrete. Generally, the range of the cube compressive strength, $f_{ck,cube,150}$, is between 25 and 60 N/mm². Expansion anchors should not be set in concrete which has not cured for more than seven days. If anchors are loaded immediately after they have been set, the loading capacity can be assumed to be only the actual strength of the concrete at that time. If an anchor is set and the load applied later, the loading capacity can be assumed to be the concrete strength determined at the time of applying the load.

Cutting through reinforcement when drilling anchor holes must be avoided. If this is not possible, the design engineer responsible must be consulted first.

Avoid cutting reinforcement

Masonry

Masonry is a heterogeneous base material. The hole being drilled for an anchor can run into mortar joints or cavities. Owing to the relatively low strength of masonry, the loads taken up locally cannot be particularly high. A tremendous variety of types and shapes of masonry bricks are on the market, e.g. clay bricks, sand-lime bricks or concrete bricks, all of different shapes and either solid or with cavities. Hilti offers a range of different fastening solutions for this variety of masonry base material, e.g. the HPS-1, HRD, HUD, HIT, etc.

Different types and shapes

If there are doubts when selecting a fastener / anchor, your local Hilti sales representative will be pleased to provide assistance.

When making a fastening, care must be taken to ensure that a lay of insulation or plaster is not used as the base material. The specified anchorage depth (depth of embedment) must be in the actual base material.

Plaster coating is not a base material for fastenings

Other base materials

Aerated concrete: This is manufactured from fine-grained sand as the aggregate, lime and/or cement as the binding agent, water and aluminium as the gas-forming agent. The density is between 0.4 and 0.8 kg/dm³ and the compressive strength 2 to 6 N/mm². Hilti offers the HGN and HRD-U anchors for this base material.

Aerated concrete

Lightweight concrete: This is concrete which has a low density, i.e. ≤ 1800 kg/m³, and a porosity that reduces the strength of the concrete and thus the loading capacity of an anchor. Hilti offers the HRD, HUD, HGN, etc anchor systems for this base material.

Lightweight concrete

Drywall (plasterboard/gypsum) panels: These are mostly building components without a supporting function, such as wall and ceiling panels, to which less important, so-called secondary fastenings are made. The Hilti anchors suitable for this material are the HTB, HLD and HHD.

Drywall / gypsum panels

In addition to the previously named building materials, a large variety of others, e.g. natural stone, etc, can be encountered in practice. Furthermore, special building components are also made from the previously mentioned materials which, because of manufacturing method and configuration, result in base materials with peculiarities that must be given careful attention, e.g. hollow ceiling floor components, etc.

Variety of base materials

Descriptions and explanations of each of these would go beyond the bounds of this manual. Generally though, fastenings can be made to these materials. In some cases, test reports exist for these special materials. It is also recommended that the design engineer, company carrying out the work and Hilti technical staff hold a discussion in each case.

In some cases, testing on the jobsite should be arranged to verify the suitability and the loading capacity of the selected anchor.

Jobsite tests

Why does an anchor hold in a base material?

Working principles

There are three basic working principles which make an anchor hold in a building material:

Friction

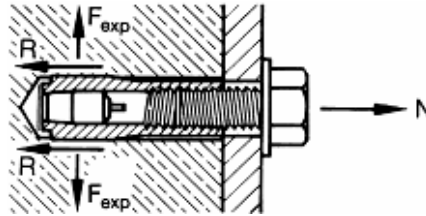

The tensile load, N , is transferred to the base material by friction, R . The expansion force, F_{exp} , is necessary for this to take place. It is produced, for example, by driving in an expansion plug (HKD).

Keying

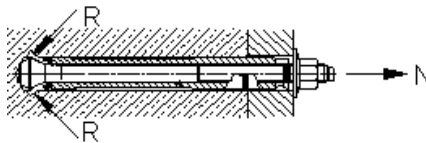

The tensile load, N , is in equilibrium with the supporting forces, R , acting on the base material, such as with the HDA anchor.

Bonding

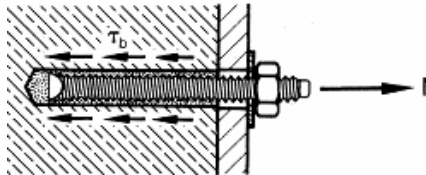

An adhesive bond is produced between the anchor rod and the hole wall by a synthetic resin adhesive, such as with HVU with HAS anchor rods.

Combination of working principles

Many anchors obtain their holding power from a combination of the above mentioned working principles.

For example, an anchor exerts an expansion force against wall of its hole as a result of the displacement of a cone relative to a sleeve. This permits the longitudinal force to be transferred to the anchor by friction. At the same time, this expansion force causes permanent local deformation of the base material, above all in the case of metal anchors. A keying action results which enables the longitudinal force in the anchor to be transferred additionally to the base material

Force-controlled and displacement-controlled expansion anchors

In the case of expansion anchors, a distinction is made between force-controlled and movement-controlled types. The expansion force of force-controlled expansion anchors is dependent on the tensile force in the anchor (HSL-3 heavy-duty anchor). This tensile force is produced, and thus controlled, when a tightening torque is applied to expand the anchor.

In the case of movement-controlled types, expansion takes place over a distance that is predetermined by the geometry of the anchor in the expanded state. Thus an expansion force is produced (HKD anchor) which is governed by the modulus of elasticity of the base material.

Adhesive/resin anchor

The synthetic resin of an adhesive anchor infiltrates into the pores of the base material and, after it has hardened and cured, achieves a local keying action in addition to the bond.

Failure modes

Effects of static loading

The failure patterns of anchor fastenings subjected to a continually increased load can be depicted as follows:

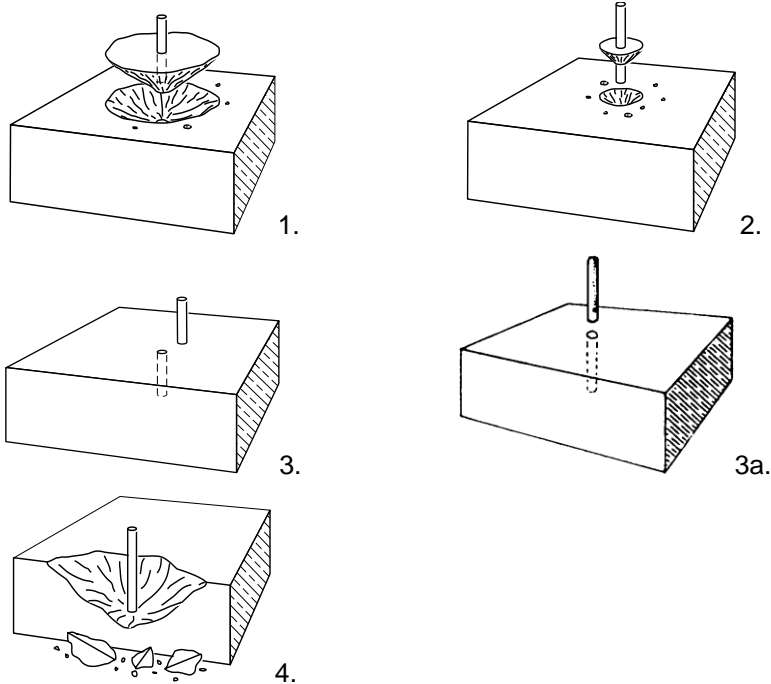

The weakest point in an anchor fastening determines the cause of failure. Modes of failure, 1. break-out, 2. anchor pull-away and, 3., 3a., failure of anchor parts, occur mostly when single anchors that are a suitable distance from an edge or the next anchor, are subjected to a pure tensile load. These causes of failure govern the max. loading capacity of anchors. On the other hand, a small edge distance causes mode of failure 4. edge breaking. The ultimate loads are then smaller than those of the previously mentioned modes of failure. The tensile strength of the fastening base material is exceeded in the cases of break-out, edge breaking and splitting.

Basically, the same modes of failure take place under a combined load. The mode of failure 1. break-out, becomes more seldom as the angle between the direction of the applied load and the anchor axis increases.

Generally, a shear load causes a conchoidal (shell-like) area of spall on one side of the anchor hole and, subsequently, the anchor parts suffer bending tension or shear failure. If the distance from an edge is small and the shear load is towards the free edge of a building component, however, the edge breaks away.

Causes of failure

Combined load

Shear load

Influence of cracks

Very narrow cracks are not defects in a structure

It is not possible for a reinforced concrete structure to be built which does not have cracks in it under working conditions. Provided that they do not exceed a certain width, however, it is not at all necessary to regard cracks as defects in a structure. With this in mind, the designer of a structure assumes that cracks will exist in the tension zone of reinforced concrete components when carrying out the design work (condition II). Tensile forces from bending are taken up in a composite construction by suitably sized reinforcement in the form of ribbed steel bars, whereas the compressive forces from bending are taken up by the concrete (compression zone).

Efficient utilisation of reinforcement

The reinforcement is only utilised efficiently if the concrete in the tension zone is permitted to be stressed (elongated) to such an extent that it cracks under the working load. The position of the tension zone is determined by the static / design system and where the load is applied to the structure. Normally, the cracks run in one direction (line or parallel cracks). Only in rare cases, such as with reinforced concrete slabs stressed in two planes, can cracks also run in two directions.

Loadbearing mechanisms

Testing and application conditions for anchors are currently being drafted internationally based on the research results of anchor manufacturers and universities. These will guarantee the functional reliability and safety of anchor fastenings made in cracked concrete.

When anchor fastenings are made in non-cracked concrete, equilibrium is established by a tensile stress condition of rotational symmetry around the anchor axis. If a crack exists, the loadbearing mechanisms are seriously disrupted because virtually no annular tensile forces can be taken up beyond the edge of the crack. The disruption caused by the crack reduces the loadbearing capacity of the anchor system.

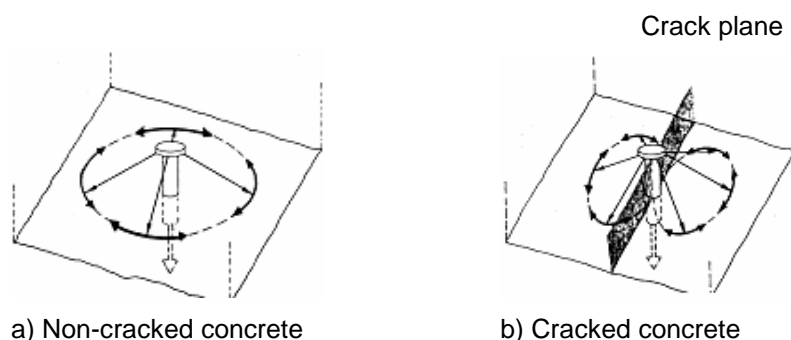

Reduction factor for cracked concrete

The width of a crack in a concrete component has a major influence on the tensile loading capacity of all fasteners, not only anchors, but also cast-in items, such as headed studs. A crack width of about 0.3mm is assumed when designing anchor fastenings. The reduction factor which can be used for the ultimate tensile loads of anchor fastenings made in cracked concrete as opposed to non-cracked concrete may be assumed to be 0.65 to 0.70 for the HSC anchor, for example. Larger reduction factors for ultimate tensile loads must be anticipated (used in calculations) in the case of all those anchors which were set in the past without any consideration of the above-mentioned influence of cracks. In this respect, the safety factor to use to allow for the failure of cracked concrete is not the same as the figure given in product information, i.e. all previous figures in the old anchor manual. This is an unacceptable situation which is being eliminated through specific testing with anchors set in cracked concrete, and adding suitable information to the product description sheets.

Since international testing conditions for anchors are based on the above-mentioned crack widths, no theoretical relationship between ultimate tensile loads and different crack widths has been given.

The statements made above apply primarily to static loading conditions. If the loading is dynamic, the clamping force and pretensioning force in an anchor bolt / rod play a major role. If a crack propagates in a reinforced concrete component after an anchor has been set, it must be assumed that the pretensioning force in the anchor will decrease and, as a result, the clamping force from the fixture (part fastened) will be reduced (lost). The properties of this fastening for dynamic loading will then have deteriorated. To ensure that an anchor fastening remains suitable for dynamic loading even after cracks appear in the concrete, the clamping force and pretensioning force in the anchor must be upheld. Suitable measures to achieve this can be sets of springs or similar devices.

As a structure responds to earthquake ground motion it experiences displacement and consequently deformation of its individual members. This deformation leads to the formation and opening of cracks in members. Consequently all anchorages intended to transfer earthquake loads should be suitable for use in cracked concrete and their design should be predicted on the assumption that cracks in the concrete will cycle open and closed for the duration of the ground motion.

Parts of the structures may be subjected to extreme inelastic deformation. In the reinforced areas yielding of the reinforcement and cycling of cracks may result in cracks width of several millimetres, particularly in regions of plastic hinges. Qualification procedures for anchors do not currently anticipate such large crack widths. For this reason, anchorages in this region where plastic hinging is expected to occur, such as the base of shear wall and joint regions of frames, should be avoided unless apposite design measures are taken.

Pretensioning force in anchor bolts / rods

Loss of pretensioning force due to cracks

Seismic loads and cracked concrete

Anchor design

Safety concept

Depending on the application and the anchor type one of the following two concepts can be applied:

For anchors for use in concrete having an European Technical Approval (ETA) the partial safety factor concept according to the European Technical Approval Guidelines ETAG 001 or ETAG 020 shall be applied. It has to be shown, that the value of design actions does not exceed the value of the design resistance: $S_d \leq R_d$.

For the characteristic resistance given in the respective ETA, reduction factors due to e.g. freeze/thaw, service temperature, durability, creep behaviour and other environmental or application conditions are already considered.

In addition to the design resistance, in this manual recommended loads are given, using an overall partial safety factor for action $\gamma = 1,4$.

Partial safety factor concept

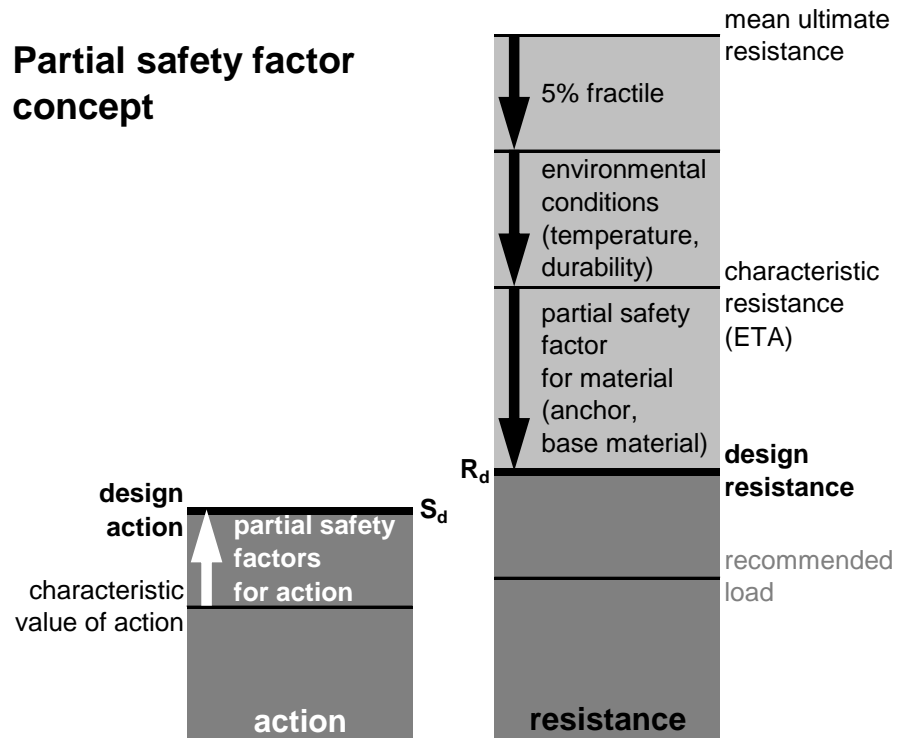

Global safety factor concept

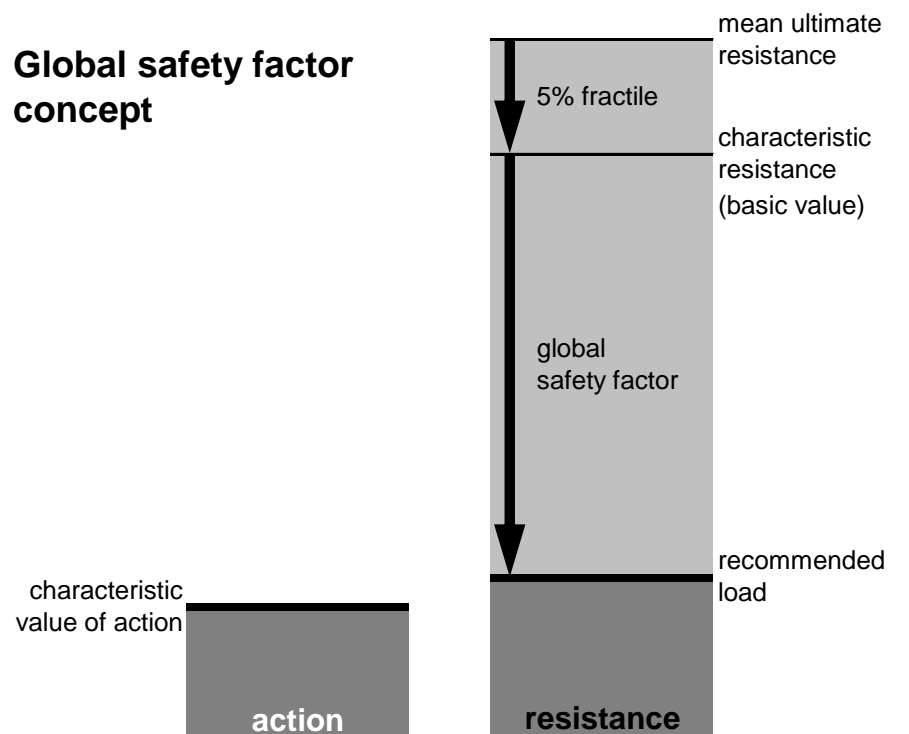

For the global safety factor concept it has to be shown, that the characteristic value of action does not exceed the recommend load value.

The characteristic resistance given in the tables is the 5% fractile value obtained from test results under standard test conditions. With a global safety factor all environmental and application conditions for action and resistance are considered, leading to a recommended load.

Design methods

Metal anchors for use in concrete according ETAG 001

The design methods for metal anchors for use in concrete are described in detail in Annex C of the European Technical Approval guideline ETAG 001 and for bonded anchors with variable embedment depth in EOTA Technical Report TR 029. Additional design rules for redundant fastenings are given in Part 6 of ETAG 001.

The design method given in this Anchor Fastening Technology Manual is based on these guidelines. The calculations according to this manual are simplified and lead to conservative results, i.e. the results are on the safe side. Tables with basic load values and influencing factors and the calculation method are given for each anchor in the respective section.

Anchors for use in other base materials and for special applications

If no special calculation method is given, the basic load values given in this manual are valid, as long as the application conditions (e.g. base material, geometry, environmental conditions) are observed.

Redundant fastenings with plastic anchors

Design rules for redundant fastenings with plastic anchors for use in concrete and masonry for non-structural applications are given in Annex C of ETAG 020. The additional design rules for redundant fastenings are considered in this manual.

Resistance to fire

When resistance to fire has to be considered, the load values given in the section "resistance to fire" should be observed. The values are valid for a single anchor.

Hilti design software PROFIS Anchor

For a more complex and accurate design according to international and national guidelines and for applications beyond the guidelines, e.g. group of anchors with more than four anchors close to the edge or more than eight anchors far away from the edge, the Hilti design software PROFIS Anchor yields customised fastening solutions. The results can be different from the calculations according to this manual.

The following methods can be used for design using PROFIS Anchor:

- ETAG
- CEN/TS
- ACI 318-08
- CSA (Canadian standard)
- Solution for Fastening (Hilti internal design method)

Simplified design method

Simplified version of the design method A according ETAG 001, Annex C or EOTA Technical Report TR 029. Design resistance according data given in the relevant European Technical Approval (ETA)

- Influence of concrete strength
- Influence of edge distance
- Influence of spacing
- Valid for a group of two anchors. (The method may also be applied for anchor groups with more than two anchors or more than one edge. The influencing factors must then be considered for each edge distance and spacing. The calculated design loads are then on the same side: They will be lower than the exact values according ETAG 001, Annex C. To avoid this, it is recommended to use the anchor design software PROFIS anchor)

The design method is based on the following simplification:

- No different loads are acting on individual anchors (no eccentricity)

The differences to the design method given in the guideline are shown in the following.

Annex C of ETAG 001 and EOTA TR 029 compared to simplified design

Design tensile resistance

The design tensile resistance is the lower value of

- Design steel resistance $N_{Rd,s}$
- Design pull-out resistance $N_{Rd,p}$
(Design combined pull-out and concrete cone resistance for bonded anchors)
- Design concrete cone resistance $N_{Rd,c}$
- Design splitting resistance $N_{Rd,sp}$

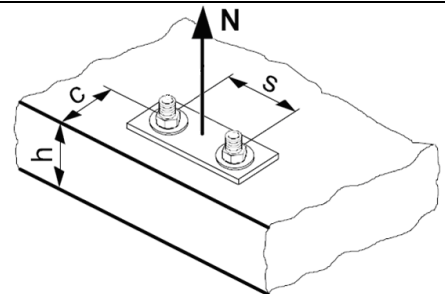

Design steel resistance $N_{Rd,s}$

Annex C of ETAG 001 / EOTA TR 029 and relevant ETA

$$N_{Rd,s} = N_{Rk,s} / \gamma_{Ms}$$

- * $N_{Rk,s}$: characteristic steel resistance
- * γ_{Ms} : partial safety factor for steel failure

* Values given in the relevant ETA

Simplified design method

$$** N_{Rd,s}$$

** Value given in the respective tables in this manual

Design pull-out resistance $N_{Rd,p}$ for anchors designed according Annex C of ETAG 001

Annex C of ETAG 001 and relevant ETA

$$N_{Rd,p} = (N_{Rk,p} / \gamma_{Mp}) \cdot \psi_c$$

- * $N_{Rk,p}$: characteristic pull-out resistance
- * γ_{Mp} : partial safety factor for pull-out failure
- * ψ_c : influence of concrete strength

* Values given in the relevant ETA

Simplified design method

$$N_{Rd,p} = N_{Rd,p}^0 \cdot f_B$$

- ** $N_{Rd,p}^0$: Basic design pull-out resistance
- ** f_B : influence of concrete strength

** Values given in the respective tables in this manual

Design combined pull-out and concrete cone resistance $N_{Rd,p}$ for bonded anchors designed according EOTA TR 029

EOTA TR 029 and relevant ETA

$$N_{Rd,p} = (N_{Rk,p}^0 / \gamma_{Mp}) \cdot (A_{p,N} / A_{p,N}^0) \cdot \psi_{s,Np} \cdot \psi_{g,Np} \cdot \psi_{ec,Np} \cdot \psi_{re,Np} \cdot \psi_c$$

where $N_{Rk,p}^0 = \pi \cdot d \cdot h_{ef} \cdot \tau_{Rk}$

$$\psi_{g,Np} = \psi_{g,Np}^0 - (s / s_{cr,Np})^{0.5} \cdot (\psi_{g,Np}^0 - 1) \geq 1$$

$$\psi_{g,Np}^0 = n^{0.5} - (n^{0.5} - 1) \cdot \{(d \cdot \tau_{Rk}) / [k \cdot (h_{ef} \cdot f_{ck,cube})^{0.5}]\}^{1.5} \geq 1$$

$$s_{cr,Np} = 20 \cdot d \cdot (\tau_{Rk,ucr} / 7.5)^{0.5} \leq 3 \cdot h_{ef}$$

* γ_{Mp} : partial safety factor for combined pull-out and concrete cone failure

+ $A_{p,N}^0$: influence area of an individual anchor with large spacing and

edge distance at the concrete surface (idealised)

+ $A_{p,N}$: actual influence area of the anchorage at the concrete surface, limited by overlapping areas of adjoining anchors and by edges of the concrete member

+ $\psi_{s,Np}$: influence of the disturbance of the distribution of stresses due to

edges

+ $\psi_{ec,Np}$: influence of excentricity

+ $\psi_{re,Np}$: influence of dense reinforcement

* ψ_c : influence of concrete strength

* d : anchor diameter

* h_{ef} : (variable) embedment depth

* τ_{Rk} : characteristic bond resistance

s : anchor spacing

$s_{cr,Np}$: critical anchor spacing

n : number of anchors in a anchor

group

k : = 2,3 in cracked concrete

= 3,2 in non-cracked concrete

$f_{ck,cube}$: concrete compressive

strength

* $\tau_{Rk,ucr}$: characteristic bond resistance for non-cracked concrete

* Values given in the relevant ETA

+ Values have to be calculated according data given in the relevant ETA (details of calculation see TR 029. The basis of the calculations may depend on the critical anchor spacing).

Simplified design method

$$N_{Rd,p} = N_{Rd,p}^0 \cdot f_{B,p} \cdot f_{1,N} \cdot f_{2,N} \cdot f_{3,N} \cdot f_{h,p} \cdot f_{re,N}$$

** $N_{Rd,p}^0$: Basic design combined pull-out and concrete cone resistance

** $f_{B,p}$: influence of concrete strength

** $f_{1,N}, f_{2,N}$: influence of edge distance

** $f_{3,N}$: influence of anchor spacing

** $f_{h,p}$: influence of (variable) embedment depth

** $f_{re,N}$: influence of dense reinforcement

** Values given in the respective tables in this manual

For the simplified design method the factor $\psi_{g,Np}$ (see TR 029) is assumed to be 1 and the critical anchor spacing is assumed to be $s_{cr,Np} = 3 \cdot h_{ef}$, both leading to conservative results = being on the save side.

Design concrete cone resistance $N_{Rd,c}$
**Annex C of ETAG 001 / EOTA TR 029
and relevant ETA**

$$N_{Rd,c} = (N_{Rk,c}^0 / \gamma_{Mc}) \cdot (A_{c,N} / A_{c,N}^0) \cdot \psi_{s,N} \cdot \psi_{re,N} \cdot \psi_{ec,N}$$

 $\psi_{ec,N}$

where $N_{Rk,c}^0 = k_1 \cdot f_{ck,cube}^{0,5} \cdot h_{ef}^{1,5}$

* γ_{Mc} : partial safety factor for concrete cone failure

+ $A_{c,N}^0$: area of concrete cone of an individual anchor with large spacing

and edge distance at the concrete surface (idealised)

+ $A_{c,N}$: actual area of concrete cone of the anchorage at the concrete surface, limited by overlapping concrete cones of adjoining anchors

and by edges of the concrete member

+ $\psi_{s,N}$: influence of the disturbance of the distribution of stresses due to edges

+ $\psi_{re,N}$: influence of dense reinforcement

+ $\psi_{ec,N}$: influence of excentricity

k_1 : = 7,2 for anchorages in cracked concrete
= 10,1 for anchorages in non-cracked concrete

$f_{ck,cube}$: concrete compressive strength

* h_{ef} : effective anchorage depth

* Values given in the relevant ETA

+ Values have to be calculated according data given in the relevant ETA (details of calculation see Annex C of ETAG 001 or EOTA TR 029)

Simplified design method

$$N_{Rd,c} = N_{Rd,c}^0 \cdot f_B \cdot f_{1,N} \cdot f_{2,N} \cdot f_{3,N} \cdot f_{h,N} \cdot f_{re,N}$$

** $N_{Rd,c}^0$: Basic design concrete cone resistance

** f_B : influence of concrete strength

** $f_{1,N}, f_{2,N}$: influence of edge distance

** $f_{3,N}$: influence of anchor spacing

** $f_{h,N}$: influence of embedment depth

** $f_{re,N}$: influence of dense reinforcement

** Values given in the respective tables in this manual

Design concrete splitting resistance $N_{Rd,sp}$

Annex C of ETAG 001 / EOTA TR 029 and relevant ETA

$$N_{Rd,sp} = (N_{Rk,c}^0 / \gamma_{Mc}) \cdot (A_{c,N} / A_{c,N}^0) \cdot \psi_{s,N} \cdot \psi_{re,N} \cdot \psi_{ec,N} \cdot \psi_{h,sp}$$

where $N_{Rk,c}^0 = k_1 \cdot f_{ck,cube}^{0,5} \cdot h_{ef}^{1,5}$

* γ_{Mc} : partial safety factor for concrete cone failure

++ $A_{c,N}^0$: area of concrete cone of an individual anchor with large spacing and edge distance at the concrete surface (idealised)

++ $A_{c,N}$: actual area of concrete cone of the anchorage at the concrete surface, limited by overlapping concrete cones of adjoining anchors and by edges of the concrete member

+ $\psi_{s,N}$: influence of the disturbance of the distribution of stresses due to edges

+ $\psi_{re,N}$: influence of dense reinforcement

+ $\psi_{ec,N}$: influence of excentricity
 k_1 : = 7,2 for anchorages in cracked concrete
 = 10,1 for anchorages in non-cracked concrete

+ $\psi_{h,sp}$: influence of the actual member depth

* $f_{ck,cube}$: concrete compressive strength
 * h_{ef} : embedment depth

* Values given in the relevant ETA
 + Values have to be calculated according data given in the relevant ETA (details of calculation see Annex C of ETAG 001 or EOTA TR 029)

++ Values of $A_{c,N}^0$ and $A_{c,N}$ for splitting failure may be different from those for concrete cone failure, due to different values for the critical edge distance and critical anchor spacing

Simplified design method

$$N_{Rd,sp} = N_{Rd,c}^0 \cdot f_B \cdot f_{1,sp} \cdot f_{2,sp} \cdot f_{3,sp} \cdot f_{h,N} \cdot f_{re,N}$$

** $N_{Rd,c}^0$: Basic design concrete cone resistance

** f_B : influence of concrete strength

** $f_{1,sp}, f_{2,sp}$: influence of edge distance

** $f_{3,sp}$: influence of anchor spacing

** $f_{h,N}$: influence of base material thickness (concrete member depth)

** $f_{re,N}$: influence of dense reinforcement

** Values given in the respective tables in this manual

Design shear resistance

The design shear resistance is the lower value of

- Design steel resistance $V_{Rd,s}$
- Design concrete pryout resistance $V_{Rd,cp}$
- Design concrete edge resistance $V_{Rd,c}$

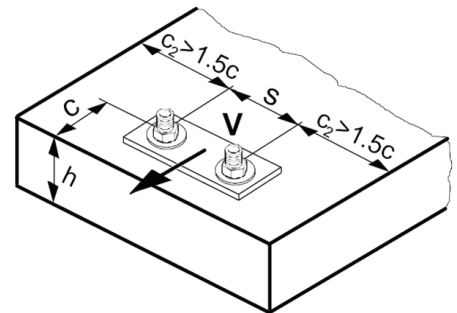

Design steel resistance $V_{Rd,s}$ (without lever arm)

Annex C of ETAG 001 / EOTA TR 029 and relevant ETA

$$V_{Rd,s} = V_{Rk,s} / \gamma_{Ms}$$

* $V_{Rk,s}$: characteristic steel resistance
 * γ_{Ms} : partial safety factor for steel failure

* Values given in the relevant ETA

For steel failure with lever arm see Annex C of ETAG 001 or EOTA TR 029

Simplified design method

$$** V_{Rd,s}$$

** Value given in the respective tables in this manual

Steel failure with lever arm is not considered for the simplified design method

Design concrete pryout resistance $V_{Rd,cp}$ for anchors designed according Annex C of ETAG 001

Annex C of ETAG 001 and relevant ETA

$$V_{Rd,cp} = (V_{Rk,cp} / \gamma_{Mp/Mc}) = k \cdot N_{Rd,c}$$

$$N_{Rd,c} = N_{Rk,c} / \gamma_{Mc}$$

for $N_{Rk,c}$: characteristic tension resistance
 concrete cone failure
 (see design concrete cone failure)

* γ_{Mc} : partial safety factor for concrete cone failure (see design concrete cone failure)

* k : influence of embedment depth

* Values given in the relevant ETA

Simplified design method

$$V_{Rd,cp} = k \cdot N_{Rd,c}$$

*** $N_{Rd,c}$: characteristic tension resistance for concrete cone failure
 (see design concrete cone failure)

** k : influence of embedment depth

** Value given in the respective tables in this manual

Design concrete pryout resistance $V_{Rd,cp}$ for bonded anchors designed according EOTA TR 029

EOTA TR 029 and relevant ETA

$V_{Rd,cp} = (V_{Rk,cp} / \gamma_{Mp/Mc}) = k \cdot \text{lower value of } N_{Rd,p} \text{ and } N_{Rd,c}$
 $N_{Rd,p} = N_{Rk,p} / \gamma_{Mp}$
 $N_{Rd,c} = N_{Rk,c} / \gamma_{Mc}$
 $N_{Rd,p}$: characteristic tension resistance for combined pull-out and concrete failure (see design combined pull-out and concrete cone failure)
 $N_{Rk,p}$: characteristic tension resistance for concrete cone failure (see design concrete cone failure)
 γ_{Mp} : partial safety factor for combined pull-out and concrete cone failure (see design combined pull-out and concrete cone failure)
 γ_{Mc} : partial safety factor for concrete failure (see design concrete cone failure)
 k : influence of embedment depth
 * Values given in the relevant ETA

Simplified design method

$V_{Rd,cp} = k \cdot \text{lower value of } N_{Rd,p} \text{ and } N_{Rd,c}$
 $N_{Rd,p}$: characteristic tension resistance for combined pull-out and concrete cone failure (see design combined pull-out and concrete cone failure)
 $N_{Rk,c}$: characteristic tension resistance for concrete cone failure (see design concrete cone failure)
 k : influence of embedment depth
 ** Values given in the respective tables in this manual

Design concrete edge resistance $V_{Rd,c}$

Annex C of ETAG 001 / EOTA TR 029 and relevant ETA

$$V_{Rd,c} = (V_{RK,c}^0 / \gamma_{Mc}) \cdot (A_{c,v} / A_{c,v}^0) \cdot \psi_{s,v} \cdot \psi_{h,v} \cdot \psi_{\alpha,v} \cdot \psi_{ec,v} \cdot \psi_{re,v}$$

where $V_{RK,c}^0 = k_1 \cdot d^\alpha \cdot h_{ef}^\beta \cdot f_{ck,cube}^{0,5} \cdot c_1^{1,5}$

$$\alpha = 0,1 \cdot (h_{ef} / c_1)^{0,5}$$

$$\beta = 0,1 \cdot (d / c_1)^{0,2}$$

- * γ_{Mc} : partial safety factor for concrete failure
- + $A_{c,v}^0$: area of concrete cone of an individual anchor at the lateral concrete surface not affected by edges (idealised)
- + $A_{c,v}$: actual area of concrete cone of anchorage at the lateral concrete surface, limited by overlapping concrete cones of adjoining anchors, by edges of the concrete member and by member thickness
- + $\psi_{s,v}$: influence of the disturbance of the distribution of stresses due to further edges
- + $\psi_{h,v}$: takes account of the fact that the shear resistance does not decrease proportionally to the member thickness as assumed by the idealised ratio $A_{c,v} / A_{c,v}^0$
- ++ $\psi_{\alpha,v}$: Influence of angle between load applied and the direction perpendicular to the free edge
- ++ $\psi_{ec,v}$: influence of excentricity
- ++ $\psi_{re,v}$: influence of reinforcement
- k_1 : = 1,7 for anchorages in cracked concrete
= 2,4 for anchorages in non-cracked concrete
- * d : anchor diameter
- $f_{ck,cube}$: concrete compressive strength
- c_1 : edge distance

* Values given in the relevant ETA
+ Values have to be calculated according data given in the relevant ETA (details of calculation see Annex C of ETAG 001 or EOTA TR 029)
++ Details see Annex C of ETAG 001 or EOTA TR 029

Simplified design method

$$V_{Rd,c} = V_{Rd,c}^0 \cdot f_B \cdot f_{\beta} \cdot f_h \cdot f_4 \cdot f_{hef} \cdot f_c$$

- ** $V_{Rd,c}^0$: Basic design concrete edge resistance
- ** f_B : influence of concrete strength
- ** f_{β} : Influence of angle between load applied and the direction perpendicular to the free edge
- ** f_h : Influence of base material thickness
- ** f_4 : Influence of anchor spacing and edge distance
- ** f_{hef} : influence of embedment depth
- ** f_c : influence of edge distance

** Values given in the respective tables in this manual

The factors f_{hef} and f_c replace the function $d^\alpha \cdot h_{ef}^\beta$, leading to conservative results = being on the safe side.

Special case: more than 2 anchors close to an edge

For a group of anchors f_4 can be calculated according to the following equation, if all anchors are equally loaded. This can be achieved by filling the annular gaps with a high performance injection mortar (e.g. Hilti HIT-RE 500-SD or Hilti HIT-HY 150 MAX).

$$f_4 = \left(\frac{c}{h_{ef}} \right)^{1,5} \cdot \left(1 + \frac{s_1 + s_2 + \dots + s_{n-1}}{3 \cdot c} \right) \cdot \frac{1}{n}$$

Where $s_1, s_2, \dots, s_{n-1} \leq 3c$

And $c_{2,1}, c_{2,2} \geq 1,5c$

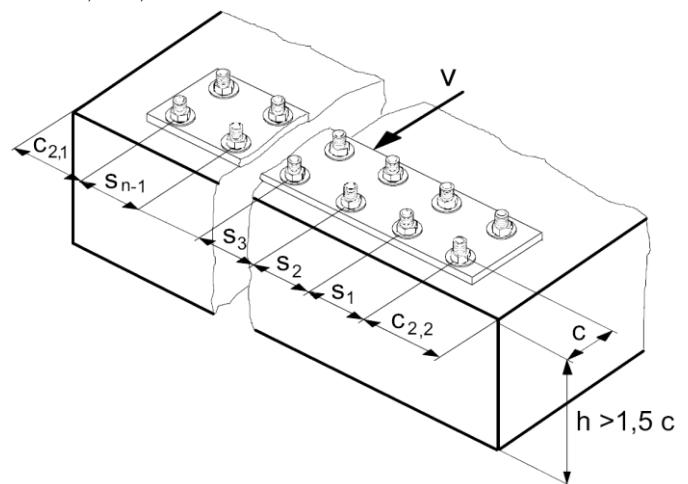

Combined tension and shear loading

The following equations must be satisfied

$$\beta_N \leq 1$$

$$\beta_V \leq 1$$

$$\beta_N + \beta_V \leq 1,2 \text{ or } \beta_N^\alpha + \beta_V^\alpha \leq 1$$

With

$$\beta_N = N_{Sd} / N_{Rd} \text{ and}$$

$$\beta_V = V_{Sd} / V_{Rd}$$

$N_{Sd} (V_{Sd})$ = tension (shear)
design action

$N_{Rd} (V_{Rd})$ = tension (shear)
design resistance

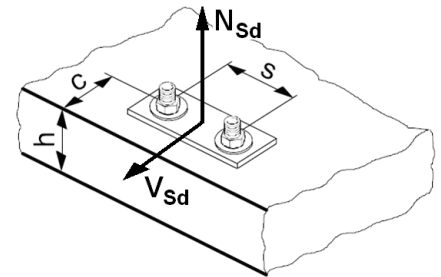

Annex C of ETAG 001

$\alpha = 2,0$ if N_{Rd} and V_{Rd} are governed by steel failure

$\alpha = 1,5$ for all other failure modes

Simplified design method

Failure mode is not considered for the simplified method

$\alpha = 1,5$ for all failure modes (leading to conservative results = being on the safe side)

Design example

Adhesive anchoring system with variable embedment depth in non-cracked concrete

Anchoring conditions

concrete	Non-cracked concrete C50/60		
service temperature range of base material	temperature range II		
number of anchors	Group of two anchors close to the edge		
base material thickness	h	100 mm	
anchor spacing	s	150 mm	
edge distance	c	100 mm	
shear load direction perpendicular to free edge	β	0°	
TENSION design action (fixing point)	N_{Sd}	15,0 kN	
SHEAR design action (fixing point)	V_{Sd}	15,0 kN	
TENSION design action per anchor	$N_{Sd}^{(1)}$	7,5 kN	
SHEAR design action per anchor	$V_{Sd}^{(1)}$	7,5 kN	
effective anchorage depth	h_{ef}	70 mm	

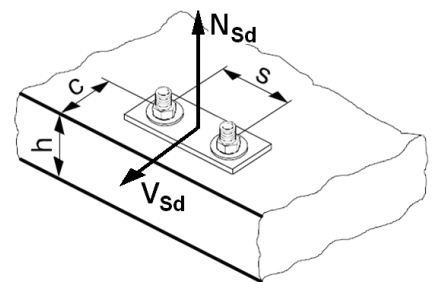

The parameters are given in the anchor-section in the tables “setting details” and “setting parameters” (for HIT-RE 500-SD with HIT-V 5.8, size M12)

anchor	Hilti HIT-RE 500-SD with HIT-V 5.8, size M12		
external diameter	d	12 mm	
typical anchorage depth	$h_{ef,typ}$	110 mm	
minimum edge distance	s_{min}	60 mm	
minimum spacing	c_{min}	60 mm	

Critical spacings and edge distances

critical spacing for concrete cone failure $s_{cr,N}$ and critical spacing for combined pull-out and concrete cone failure $s_{cr,Np}$

$h_{ef} =$	70 mm	$s_{cr,N} = s_{cr,Np} = 3 h_{ef} =$	210 mm
------------	-------	-------------------------------------	--------

critical edge distance for concrete cone failure $c_{cr,N}$ and critical edge distance for combined pull-out and concrete cone failure $c_{cr,Np}$

$h_{ef} =$	70 mm	$c_{cr,N} = c_{cr,Np} = 1,5 h_{ef} =$	105 mm
------------	-------	---------------------------------------	--------

critical edge distance for splitting failure

for $h \leq 1,3 h_{ef}$		$c_{cr,sp} = 2,26 h_{ef}$	
for $1,3 h_{ef} < h < 2 h_{ef}$		$c_{cr,sp} = 4,6 h_{ef} - 1,8 h$	
for $h \geq 2 h_{ef}$		$c_{cr,sp} = 1,0 h_{ef}$	
$h =$	100 mm	$h_{ef} =$ 70 mm	
$h/h_{ef} =$	1,43	$\rightarrow c_{cr,sp} =$	142 mm

critical spacing for splitting failure

$c_{cr,sp} =$	142 mm	$s_{cr,sp} = 2 c_{cr,sp} =$	284 mm
---------------	--------	-----------------------------	--------

General remarks

According EOTA Technical Report TR 029, concrete cone, combined concrete cone and pull-out, splitting, pryout and concrete edge design resistance must be verified for the anchor group. Steel design resistance must be verified for the most unfavourable anchor of the anchor group.

According to the simplified design method given in this Fastening Technology Manual all anchors of a group are loaded equally, the design resistance values given in the tables are valid for one anchor.

Tension loading

Design steel resistance

$N_{Rd,s} =$	28,0 kN
--------------	----------------

See “basic design tensile resistance”
(for HIT-RE 500-SD with HIT-V 5.8, size M12)

Design combined pull-out and concrete cone resistance

basic resistance				$N_{Rd,p}^0$	29,9 kN	
concrete		Non-cracked concrete C50/60		$f_{B,p}$	1,09	
$h_{ef} = 70$ mm	$h_{ef,typ} = 110$ mm			$f_{h,p} = h_{ef}/h_{ef,typ} =$	0,64	
$c = 100$ mm	$c_{cr,N} = 105$ mm	$c/c_{cr,N} = 0,95$	→	$f_{1,N}$	0,99	
				$f_{2,N}$	0,97	
$s = 150$ mm	$s_{cr,N} = 210$ mm	$s/s_{cr,N} = 0,71$	→	$f_{3,N}$	0,86	
$h_{ef} = 70$ mm				→	$f_{re,N}$	1,00
$N_{Rd,p} = N_{Rd,p}^0 f_{B,p} f_{1,N} f_{2,N} f_{3,N} f_{h,p} f_{re,N} =$					17,1 kN	

See “basic design tensile resistance”
(for HIT-RE 500-SD with HIT-V 5.8, size M12)

Design concrete cone resistance

basic resistance				$N_{Rd,c}^0$	32,4 kN	
concrete		Non-cracked concrete C50/60		f_B	1,55	
$h_{ef} = 70$ mm	$h_{ef,typ} = 110$ mm			$f_{h,N} = (h_{ef}/h_{ef,typ})^{1,5} =$	0,51	
$c = 100$ mm	$c_{cr,N} = 105$ mm	$c/c_{cr,N} = 0,95$	→	$f_{1,N}$	0,99	
				$f_{2,N}$	0,97	
$s = 150$ mm	$s_{cr,N} = 210$ mm	$s/s_{cr,N} = 0,71$	→	$f_{3,N}$	0,86	
$h_{ef} = 70$ mm				→	$f_{re,N}$	1,00
$N_{Rd,c} = N_{Rd,c}^0 f_B f_{h,N} f_{1,N} f_{2,N} f_{3,N} f_{re,N} =$					21,1 kN	

See “basic design tensile resistance”
(for HIT-RE 500-SD with HIT-V 5.8, size M12)
and “influencing factors”
(for HIT-RE 500-SD with HIT-V 5.8, size M12)

Influencing factors may be interpolated.

Design splitting resistance

basic resistance				$N_{Rd,c}^0$	32,4 kN	
concrete		Non-cracked concrete C50/60		f_B	1,55	
$h_{ef} = 70$ mm	$h_{ef,typ} = 110$ mm			$f_{h,N} = (h_{ef}/h_{ef,typ})^{1,5} =$	0,51	
$c = 100$ mm	$c_{cr,sp} = 142$ mm	$c/c_{cr,sp} = 0,70$	→	$f_{1,sp}$	0,91	
				$f_{2,sp}$	0,85	
$s = 150$ mm	$s_{cr,sp} = 284$ mm	$s/s_{cr,sp} = 0,53$	→	$f_{3,sp}$	0,76	
$h_{ef} = 70$ mm				→	$f_{re,N}$	1,00
$N_{Rd,sp} = N_{Rd,c}^0 f_B f_{h,N} f_{1,sp} f_{2,sp} f_{3,sp} f_{re,N} =$					15,0 kN	

See “basic design tensile resistance”
(for HIT-RE 500-SD with HIT-V 5.8, size M12)
and “influencing factors”
(for HIT-RE 500-SD with HIT-V 5.8, size M12)

Influencing factors may be interpolated.

Tension design resistance: lowest value	$N_{Rd} =$	15,0 kN
--	------------	----------------

Shear loading

Design steel resistance

$V_{Rd,s} =$	16,8 kN
--------------	----------------

See “basic design shear resistance”
(for HIT-RE 500-SD with HIT-V 5.8, size M12)

Concrete pryout design resistance

lower value of $N_{Rd,p}$ and $N_{Rd,c}$	$V^0 =$	17,1 kN
$h_{ef} = 70 \text{ mm}$	$\rightarrow k$	2
$V_{Rd,cp} = k V^0 =$		34,3 kN

See “basic design shear resistance”
(for HIT-RE 500-SD with HIT-V 5.8, size M12)
and “influencing factors”
(for HIT-RE 500-SD with HIT-V 5.8, size M12)

Concrete edge design resistance

basic resistance			$V^0_{Rd,c}$	11,6 kN
concrete	Non-cracked concrete C50/60		f_B	1,55
shear load direction perpendicular to free edge			$0^\circ \rightarrow f_\beta$	1,00
$h = 100 \text{ mm}$	$c = 100 \text{ mm}$	$h/c = 1,00$	$\rightarrow f_h$	0,82
$c = 100 \text{ mm}$	$h_{ef} = 70 \text{ mm}$	$c/h_{ef} = 1,43$	$\rightarrow f_4$	1,28
$s = 150 \text{ mm}$	$h_{ef} = 70 \text{ mm}$	$s/h_{ef} = 2,14$		
$h_{ef} = 70 \text{ mm}$	$d = 12 \text{ mm}$	$h_{ef}/d = 5,83$	$\rightarrow f_{hef}$	0,97
$c = 100 \text{ mm}$	$d = 12 \text{ mm}$	$c/d = 8,33$	$\rightarrow f_c$	0,67
$V_{Rd,c} = V^0_{Rd,c} f_B f_\beta f_h f_4 f_{hef} f_c =$				12,3 kN

See “basic design shear resistance”
(for HIT-RE 500-SD with HIT-V 5.8, size M12)
and “influencing factors”
(for HIT-RE 500-SD with HIT-V 5.8, size M12)

Influencing factors may be interpolated.

Shear design resistance: lowest value	$V_{Rd} =$	12,3 kN
--	------------	----------------

Combined tension and shear loading

The following equation must be satisfied for combined tension and shear loads:

$$\text{(Eq. 1)} \quad (\beta_N)^{1,5} + (\beta_V)^{1,5} \leq 1$$

β_N (β_V) ratio between design action and design resistance for tension (shear) loading

According to ETAG 001, Annex C, the following simplified equation may be applied:

$$\text{(Eq. 2)} \quad \beta_N + \beta_V \leq 1,2 \quad \text{and} \quad \beta_N \leq 1, \beta_V \leq 1$$

Example (load values are valid for one anchor)

$N_{Sd}^{(1)} = 7,5 \text{ kN}$	$\beta_N = N_{Sd}^{(1)}/N_{Rd} = 0,500 \leq 1$	✓
$V_{Sd}^{(1)} = 7,5 \text{ kN}$	$\beta_V = V_{Sd}^{(1)}/V_{Rd} = 0,612 \leq 1$	✓
$N_{Rd} = 15,0 \text{ kN}$	$\beta_N + \beta_V = 1,112 \leq 1,2$	✓
$V_{Rd} = 12,3 \text{ kN}$	$(\beta_N)^{1,5} + (\beta_V)^{1,5} = 0,832 \leq 1$	✓

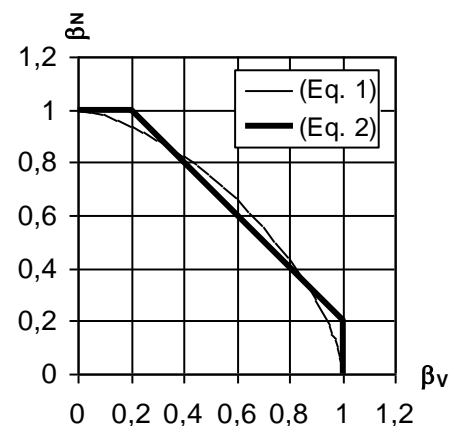

Dynamic loads (seismic, fatigue, shock)

Dynamic design for anchors

Actions	Common engineering design usually focuses around static loads. This chapter is intended to point out those cases, where static simplification may cause severe misjudgement and usually under-design of important structures.
Static loads	<p>Static loads can be segregated as follows:</p> <ul style="list-style-type: none"> • Own (dead) weight • Permanent actions • Loads of non-loadbearing components • Changing actions • working loads (fitting / furnishing , machines, "normal" wear) • Snow, Wind, Temperature
Material behaviour under static loading	The material behaviour under static loads is described essentially by the strength (tensile and compressive) and the elastic-plastic behaviour of the material. These properties are generally determined by carrying out tests according to the assessment guidelines.
Dynamic actions	The main difference between static and dynamic loads is the effectiveness of inertia and damping forces. These forces result from induced acceleration and must be taken into account when determining section forces and anchoring forces.
Typical Dynamic Actions	<p>Dynamic actions can generally be classified into 3 different groups:</p> <ul style="list-style-type: none"> • Seismic loads • Fatigue loads • Shock loads

Seismic loads

Earthquakes



Seismic anchorage applications can include strengthening or retrofitting an existing structure, as well as standard anchorage applications that exist both in seismic and non-seismic geographies. In addition to an engineers focus on the anchoring of structural elements, it is crucial for an adequate seismic design to attend to non-load bearing and non-structural elements. These elements failure can severely compromise the building/structure functionality or repair costs after a seismic event.

Concrete should be assumed cracked

As a structure responds to earthquake ground motion it experiences displacement and consequently deformation of its individual members. This deformation leads to the formation and opening of cracks in members. Consequently all anchorages intended to transfer earthquake loads should be suitable for use in cracked concrete and their design should be predicted on the assumption that cracks in the concrete will cycle open and closed for the duration of the ground motion.

Anchorages not recommended in plastic hinges areas

Parts of the structures may be subjected to extreme inelastic deformation as exposed in Fig. 1. In the reinforced areas yielding of the reinforcement and cycling of cracks may result in cracks width of several millimetres, particularly in regions of plastic hinges. Qualification procedures for anchorages do not currently anticipate such large crack widths. For this reason, anchorages in this region where plastic hinging is expected to occur, such as the base of shear wall and joint regions of frames, should be avoided unless apposite design measures are taken.

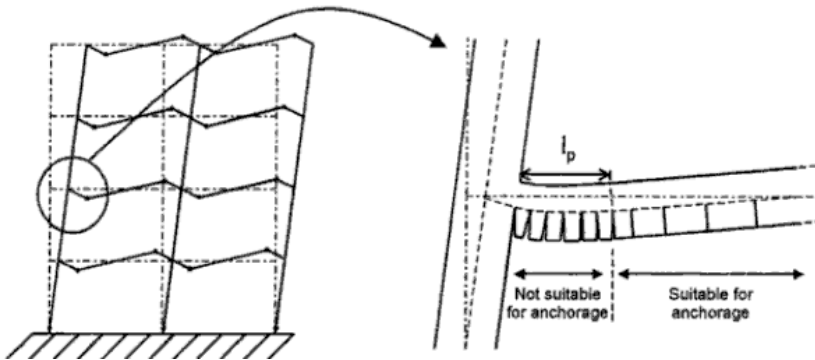

Fig 1: Member cracking assuming a strong-column, weak girder design

An anchor suitable (approved) to perform in a commonly defined cracked concrete, about 0.3 mm, is not consequently suitable to resist seismic actions, it's just a starting point.

During an earthquake cyclic loading of the structure and of the fastenings is induced simultaneously. Due to this the width of the cracks will vary between a minimum and a maximum value and the fastenings will be loaded cyclically. Specific testing programs and evaluation requirements are then necessary in order to evaluate the performance of an anchor subjected to seismic actions. Only the anchors approved after the mentioned procedure shall be specified for any safety relevant connection.

Anchors generally suitable for taking up seismic actions are those which can be given a controlled and sustained pre-tensioning force and are capable of re-expanding when cracking occurs. Also favorable are anchors which have an anchoring mechanism based on a keying (mechanical interlock) as it is the case for undercut anchors and concrete screws. Furthermore, some specific chemical anchors have also been recognized good performance to resist seismic actions, specially bond expansion anchors.

Additionally, Hilti's seismic research includes detailed investigation of product performance under simulated seismic conditions and full-scale system testing. This multilevel approach helps to capture the complexity of anchored system behaviour under seismic conditions.

In the United States the anchor seismic resistance shall be evaluated in accordance with ACI 318 Appendix D. Created in accordance with the ACI 355.2 regulated testing procedures and acceptance criteria ICC-ES AC193 and AC308, pre-qualification reports provide sound data in a proper design format.

With the release of the ETAG 001 Annex E in the first half of 2013, the seismic pre-qualification of anchors became regulated in Europe. Anchors submitted to these new test procedures will now also incorporate in the ETA (European Technical Approval) all the required technical data for seismic design. Until the release of the EN 1992-4, planned for 2015, EOTA TR045 (Technical Report) will set the standard for the seismic design of steel to concrete connections.

Therefore, the design framework for the seismic design of anchors is already available through both the U.S. and European regulations.

After a strong or design earthquake occasion, the ultimate loading capacity of an anchor is considerably reduced (30 to 80% of the original resistance). Proper inspection shall then be carried to ensure the level of performance not only for a future earthquake but also for the static load combinations.

Specific testing programs are needed to assess anchors

Anchors suitable to endure seismic loading

Full scale system testing

Seismic anchor design regulations landscape

After an earthquake

Fatigue loads

Fatigue

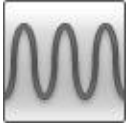

Material behaviour under fatigue impact

If an anchor is subjected to a sustained load that changes with respect to time, it can fail after a certain number of load cycles even though the upper limit of the load withstood up to this time is clearly lower than the ultimate tensile strength under static loading. This loss of strength is referred to as material fatigue. When evaluating actions causing fatigue also the planned or anticipated fastening life expectancy is of major importance.

The grade and quality of steel has a considerable influence on the alternating strength. In the case of structural and heat-treatable steels, the final strength (i.e. after 2 million load cycles or more) is approx. 25-35% of the static strength.

In the non-loaded state, concrete already has micro-cracks in the zone of contact of the aggregates and the cement paste, which are attributable to the aggregates hindering shrinkage of the cement paste. The fatigue strength of concrete is directly dependent on the grade of concrete. Concrete strength is reduced to about 55 – 65% of the initial strength after 2'000'000 load cycles.

Examples for Fatigue Loads

Two main groups of fatigue type loading can be identified:

- Vibration type loading of fasteners with very high recurrence and usually low amplitude (e.g. ventilators, production machinery, etc.).
- Repeated loading and unloading of structures with high loads and frequent recurrence (cranes, elevators, robots, etc.).

Shock loads

Shock



Examples of Shock Loading

Shock-like phenomena have a very short duration and generally tremendously high forces which, however, only occur as individual peaks. As the probability of such a phenomenon to occur during the life expectancy of the building components concerned is comparably small, plastic deformations of fasteners and structural members are permitted according to the pre-qualification criteria.

Shock loads are mostly unusual loading situations, even though sometimes they are the only loading case a structure is designed for (e.g. crash barriers, protection nets, ship or aeroplane impacts and falling rocks, avalanches and explosions, etc.).

Shock Testing

Load increase times in the range of milliseconds can be simulated during tests on servo-hydraulic testing equipment. The following main effects can then be observed:

- Deformation is greater when the breaking load is reached
- The energy absorbed by an anchor is also much higher
- Breaking loads are of roughly the same magnitude during static loading and shock-loading tests

In this respect, more recent investigations show that the base material (cracked or non-cracked concrete), has no direct effect on the load-bearing behaviour.

Dynamic set for shear resistance upgrade

If a multiple-anchor fastening is loaded towards the edge of a concrete member (shear load), the gap between anchor shaft and clearance hole has an important role. An uneven shear load distribution within the anchors in the fastening is the result as the clearance hole is always larger than the anchor diameter to ensure an easy installation. Design methods take this fact into account by assuming that only the row of anchors nearest to the concrete edge takes up all shear load.

Uneven shear load distribution

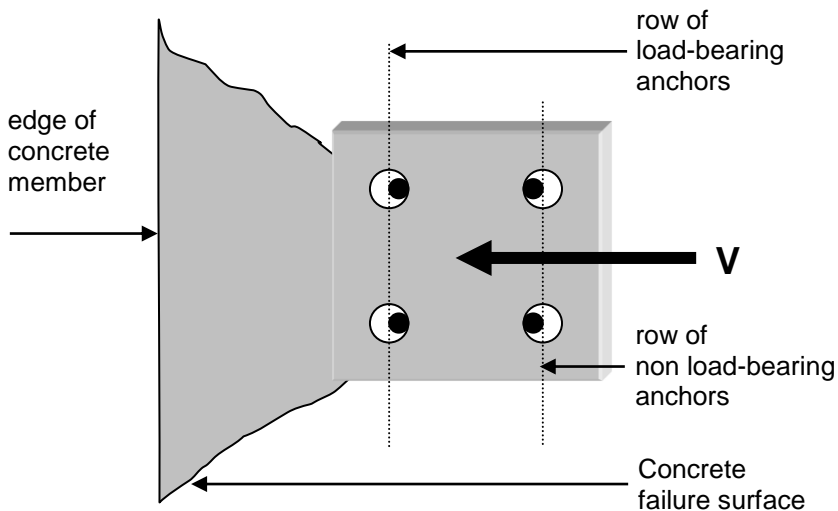

The second row of anchors can be activated only after a considerable slip of the anchoring plate. This slip normally takes place after the edge failure of the outside row. The effect of the clearance hole gap on the internal load distribution increases if the shear load direction changes during the service life. To make anchors suitable for alternating shear loads, Hilti developed the so called Dynamic Set. This consists of a special washer, which permits HIT injection adhesive to be dispensed into the clearance hole, a spherical washer, a nut and a lock nut.

Activating the second row of anchors

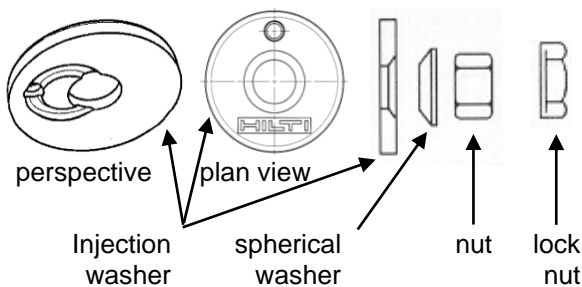

Dynamic Set

- Injection washer:** Fills clearance hole and thus guarantees that the load is uniformly distributed among all anchors.
- Spherical washer:** Reduces bending moment acting on anchor shaft not set at right angles and thus increases the tensile loading capacity.
- Lock nut:** Prevents loosening of the nut and thus lifting of the anchoring plate away from the concrete in case of cyclic loading.

Improvements with Dynamic Set

Delivery programme Dynamic Set: M10, M12, M16, M20

Shear resistance improvement with Dynamic Set

By using the dynamic set for static fastenings, the shear resistance is improved significantly. The unfavourable situation that only one row of anchors takes up all loads no longer exists and the load is distributed uniformly among all anchors. A series of experiments has verified this assumption. An example from this test programme, double fastenings with HVZ M10 anchors with and without the Dynamic Set are shown to compare resulting shear resistance and stiffness.

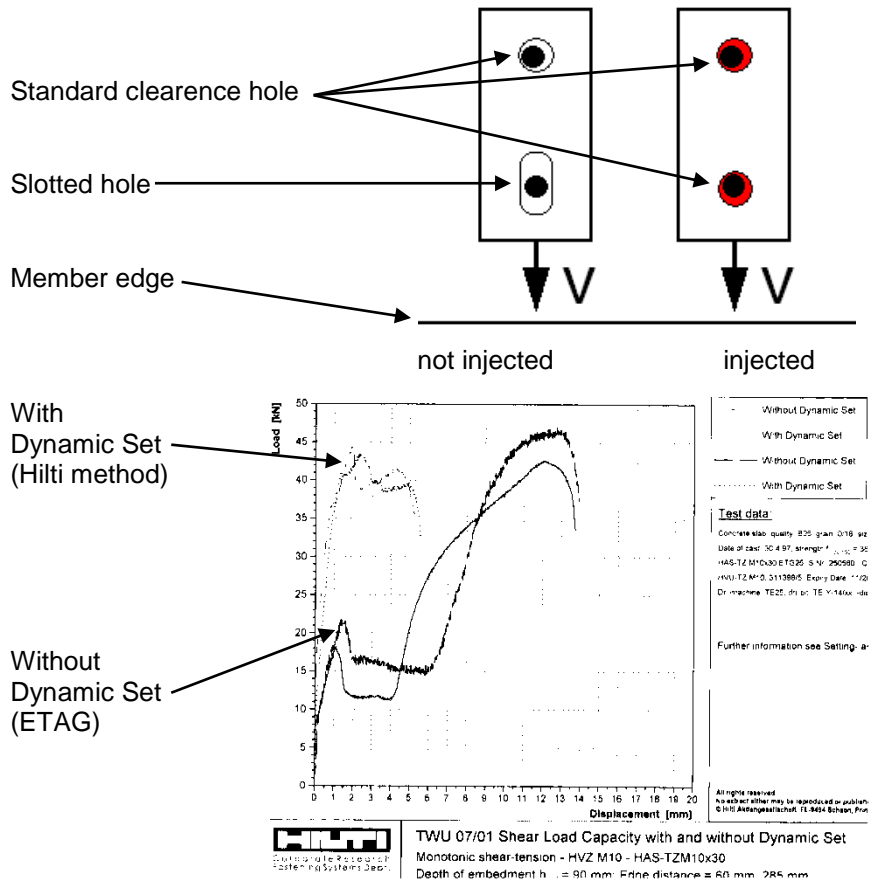

The test results show clearly that according to the current practice the second row of anchors takes up the load only after significant deformation of the plate, when the concrete edge has already failed. The injection and the Dynamic Set resulted in a continuous load increase until the whole multiple fastening fails.



When carrying out a simple fastening design, it may be assumed if the Dynamic Set is used the overall load bearing capacity of the multiple fastening is equal to the resistance of the first row of anchors multiplied by the number of rows in the fastening. In addition to that it must be checked whether the concrete edge resistance of the farthest row is smaller than the above mentioned resistance. If injection with the Dynamic Set is used, the ETAG restrictions on more than 6 anchor fastenings can be overcome.





Resistance to fire

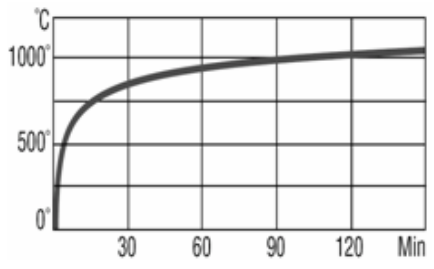

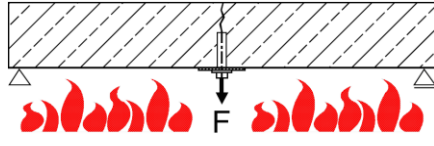





Tested fasteners for passive structural fire prevention





Tested according to the international standard temperature curve

MFPA Leipzig GmbH 	Tested according to the international standard temperature curve (ISO 834, DIN 4102 T.2) and/or to EOTA Technical Report TR 020 (Evaluation of Anchorages in Concrete concerning Resistance to Fire)	
	Tested when set in cracked concrete and exposed to flames without insulating or protective measures.	



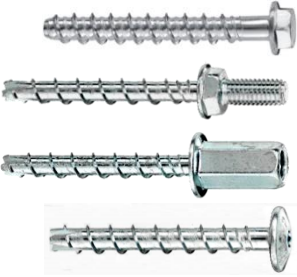



Anchor / fastener	Size	Max. loading (kN) for specified fire resistance time (fire resistance time in minutes)				Authority / No.
		F30	F60	F90	F120	
HDA  Fire resistance data for F 180 please refer to the test reports	M10	4,5	2,2	1,3	1,0	IBMB Braunschweig UB 3039/8151
	M12	10,0	3,5	1,8	1,2	
	M16	15,0	7,0	4,0	3,0	Warringtonfire WF Report No 327804/A
	M20	25,0	9,0	7,0	5,0	
HDA-F 	M10	4,5	2,2	1,3	1,0	IBMB Braunschweig UB 3039/8151
	M12	10,0	3,5	1,8	1,2	
	M16	15,0	7,0	4,0	3,0	Warringtonfire WF Report No 327804/A
HDA-R 	M10	20,0	9,0	4,0	2,0	IBMB Braunschweig UB 3039/8151
	M12	30,0	12,0	5,0	3,0	
	M16	50,0	15,0	7,5	6,0	Warringtonfire WF Report No 327804/A
HSL-3 	M8	3,0	1,1	0,6	0,4	IBMB Braunschweig UB 3041/1663-CM
	M10	7,0	2,0	1,3	0,8	
	M12	10,0	3,5	2,0	1,2	Warringtonfire WF Report No 327804/A
	M16	19,4	6,6	3,5	2,2	
	M20	30,0	10,3	5,4	3,5	
	M24	43,0	14,8	7,9	5,0	





Anchor / fastener	Size	Max. loading (kN) for specified fire resistance time (fire resistance time in minutes)				Authority / No.
		F30	F60	F90	F120	
HSL-3-G 	M8	3,0	1,1	0,6	0,4	IBMB Braunschweig report No, 3041/1663-CM Warringtonfire WF Report No 327804/A
	M10	7,0	2,0	1,3	0,8	
	M12	10,0	3,5	2,0	1,2	
	M16	19,4	6,6	3,5	2,2	
	M20	30,0	10,3	5,4	3,5	
	M24	43,0	14,8	7,9	5,0	
HSL-3-B 	M12	10,0	3,5	2,0	1,2	IBMB Braunschweig report No. 3041/1663-CM Warringtonfire WF Report No 327804/A
	M16	19,4	6,6	3,5	2,2	
	M20	30,0	10,3	5,4	3,5	
	M24	43,0	14,8	7,9	5,0	
HSL-3-SH 	M8	1,9	1,1	0,6	0,4	IBMB Braunschweig report No. 3041/1663-CM Warringtonfire WF Report No 327804/A
	M10	4,5	2,0	1,3	0,8	
	M12	8,5	3,5	2,0	1,2	
HSL-3-SK 	M8	3,0	1,1	0,6	0,4	IBMB Braunschweig report No. 3041/1663-CM Warringtonfire WF Report No 327804/A
	M10	7,0	2,0	1,3	0,8	
	M12	10,0	3,5	2,0	1,2	
HSC-A 	M8x40	1,5	1,5	1,5	-	IBMB Braunschweig UB 3177/1722-1 Warringtonfire WF Report No 327804/A
	M8x50	1,5	1,5	1,5	-	
	M10x40	1,5	1,5	1,5	-	
	M12x60	3,5	3,5	2,0	-	
HSC-I 	M8x40	1,5	1,5	1,5	-	IBMB Braunschweig UB 3177/1722-1 Warringtonfire WF Report No 327804/A
	M10x50	2,5	2,5	2,5	-	
	M10x60	2,5	2,5	2,5	-	
	M12x60	2,0	2,0	2,0	-	
HSC-AR 	M8x40	1,5	1,5	1,5	-	IBMB Braunschweig UB 3177/1722-1 Warringtonfire WF Report No 327804/A
	M8x50	1,5	1,5	1,5	-	
	M10x40	1,5	1,5	1,5	-	
	M12x60	3,5	3,5	3,5	3,0	
HSC-IR 	M8x40	1,5	1,5	1,5	-	IBMB Braunschweig UB 3177/1722-1 Warringtonfire WF Report No 327804/A
	M10x50	2,5	2,5	2,5	-	
	M10x60	2,5	2,5	2,5	-	
	M12x60	3,5	3,5	3,5	3,0	
HST 	M8	0,9	0,7	0,6	0,5	DIBt Berlin ETA-98/0001 Warringtonfire WF Report No 327804/A Data valid for steel failure, for other failure modes see ETA-98/0001
	M10	2,5	1,5	1,0	0,7	
	M12	5,0	3,5	2,0	1,0	
	M16	9,0	6,0	3,5	2,0	
	M20	15,0	10,0	6,0	3,5	
	M24	20,0	15,0	8,0	5,0	





Anchor / fastener	Size	Max. loading (kN) for specified fire resistance time (fire resistance time in minutes)				Authority / No.
		F30	F60	F90	F120	
HST-R 	M8	4,9	3,6	2,4	1,7	DIBt Berlin ETA-98/0001 Warringtonfire WF Report No 327804/A Data valid for steel failure, for other failure modes see ETA-98/0001
	M10	11,8	8,4	5,0	3,3	
	M12	17,2	12,2	7,3	4,8	
	M16	32,0	22,8	13,5	8,9	
	M20	49,9	35,5	21,1	13,9	
	M24	71,9	51,2	30,4	20,0	
HST-HCR 	M8	4,9	3,6	2,4	1,7	DIBt Berlin ETA-98/0001 Warringtonfire WF Report No 327804/A Data valid for steel failure, for other failure modes see ETA-98/0001
	M10	11,8	8,4	5,0	3,3	
	M12	17,2	12,2	7,3	4,8	
	M16	32,0	22,8	13,5	8,9	
HSA, HSA-BW, HSA-R2, HSA-R 	M6	0,20	0,18	0,14	0,10	IBMB Braunschweig 3215/229/12 Data valid for steel failure, for other failure modes see report 3215/229/12 Warringtonfire WF Report No 327804/A
	M8	0,37	0,33	0,26	0,18	
	M10	0,87	0,75	0,58	0,46	
	M12	1,69	1,26	1,10	0,84	
	M16	3,14	2,36	2,04	1,57	
	M20	4,90	3,68	3,19	2,45	
HLC-Standard 	6,5 (M5)	0,5	0,29	0,2	0,17	IBMB Braunschweig PB 3093/517/07-CM Warringtonfire WF Report No 327804/A
	8 (M6)	0,9	0,5	0,37	0,3	
	10 (M8)	1,9	0,99	0,6	0,5	
	12(M10)	3,0	1,5	1,0	0,8	
	16(M12)	4,0	2,2	1,5	1,1	
	20(M16)	4,0	3,7	2,7	2,2	
HLC-H 	8 (M6)	0,9	0,5	0,37	0,3	IBMB Braunschweig PB 3093/517/07-CM Warringtonfire WF Report No 327804/A
	10 (M8)	1,9	0,99	0,6	0,5	
	12(M10)	3,0	1,5	1,0	0,8	
	16(M12)	4,0	2,2	1,5	1,18	
HLC-L 	10 (M8)	1,9	0,99	0,67	0,5	IBMB Braunschweig PB 3093/517/07-CM Warringtonfire WF Report No 327804/A
HLC-EC 	8 (M6)	0,9	0,5	0,37	0,3	IBMB Braunschweig PB 3093/517/07-CM Warringtonfire WF Report No 327804/A
	10 (M8)	1,9	0,99	0,67	0,5	
	16(M12)	3,0	1,5	1,0	0,79	





Anchor / fastener	Size	Max. loading (kN) for specified fire resistance time (fire resistance time in minutes)				Authority / No.
		F30	F60	F90	F120	
 HUS-HR	6x30	0,5	0,5	0,5	0,4	Hilti Tech. data
	6x35	0,7	0,7	0,7	0,5	DIBt Berlin / ETA-10/0005 acc. Part 6
	6x55	1,3	1,3	1,3	1,0	DIBt Berlin ETA-08/0307
	8x60	1,5	1,5	1,5	1,2	
	8x80	3,0	3,0	3,0	1,7	
	10x70	2,3	2,3	2,3	1,8	
	10x90	4,0	4,0	4,0	2,4	
	14x70	3,0	3,0	3,0	2,4	
14x90	6,3	6,3	6,3	5,0		
 HUS-A/-H/-I/-P	6x35	0,5	0,5	0,5	0,4	DIBt Berlin / ETA-10/0005 acc. Part 6
	6x55	1,5	1,2	0,8	0,7	DIBt Berlin ETA-08/0307
	8x60	1,5	1,5	1,3	0,8	
	8x75	2,3	2,2	1,3	0,8	
	10x70	1,9	1,9	1,9	1,5	
	10x85	4,0	3,6	2,2	1,5	
 HUS3	M8	3,2	2,4	0,5	0,4	DIBt Berlin / ETA-13/1038 Table C3
	M10	6,1	4,6	3,1	2,4	Data valid for <u>steel</u> failure, for other failure modes see ETA-13/1038
	M14	10,4	7,8	5,3	4,0	
HUS (aerated concrete, plates and bricks, strength category ≥ 6)	6	1,0	0,6	0,4	0,3	IBMB Braunschweig BB 3707/983/11 Warringtonfire WF Report No 327804/A
	-H 6					
	-A 6					
 HKD	M6x25	0,5	0,4	0,3	0,2	DIBt Berlin ETA-06/0047 acc. Part 6
	M8x25	0,6	0,6	0,6	0,5	
	M8x30	0,9	0,9	0,9	0,7	Warringtonfire WF Report No 327804/A
	M8x40	1,3	1,3	1,3	0,7	
	M10x25	0,6	0,6	0,6	0,5	
	M10x30	0,9	0,9	0,9	0,7	
	M10x40	1,8	1,8	1,8	1,5	
	M12x25	0,6	0,6	0,6	0,5	
	M12x50	2,3	2,3	2,3	1,8	
	M16x65	4,0	4,0	4,0	3,2	
 HKD-SR HKD-ER	M6x30	0,5	0,5	0,4	0,3	DIBt Berlin ETA-06/0047 acc. Part 6 Warringtonfire WF Report No 327804/A
	M8x30	0,9	0,9	0,9	0,7	
	M10x40	1,8	1,8	1,8	1,5	
	M12x50	2,3	2,3	2,3	1,8	

Anchor / fastener	Size	Max. loading (kN) for specified fire resistance time (fire resistance time in minutes)				Authority / No.
		F30	F60	F90	F120	
HRD 8 / HRD 10 	only shear loads	1,9	1,4	1,0	0,7	MFPA Leipzig GS 3.2/10-157-1
HA 8 R1 	8	0,35	0,20	0,10	0,05	IBMB Braunschweig UB 3245/1817-5 Warringtonfire WF Report No 327804/A
DBZ 	6/4,5	0,6	0,5	0,3	0,2	DIBt Berlin; ETA-06/0179 acc. Part 6 Warringtonfire WF Report No 327804/A
	6/35					
HT 	HT 8 L	0,85	0,44	0,27	0,19	IBMB Braunschweig UB 3016/1114-CM Warringtonfire WF Report No 327804/A
	HT 10 L	0,74	0,41	0,3	0,24	
	HT 10 S					
HK 	HK6	0,3	0,3	0,3	0,2	DIBt Berlin ETA-04/0043, acc. Part 6 Warringtonfire WF Report No 327804/A
	HK6L	0,6	0,5	0,3	0,2	
	HK8	1,2	1,0	0,6	0,4	
HPD 	M6	0,85	0,5	0,35	0,3	IBMB Braunschweig UB 3077/3602 -Nau- Warringtonfire WF Report No 327804/A
	M8	1,4	0,7	0,45	0,35	
	M10	2,2	1,3	0,95	0,75	
	M12	2,2	1,3	0,95	0,75	
HKH/HKH-L 	M6	1,2	0,65	0,45	0,35	IBMB Braunschweig UB 3606 / 8892 Warringtonfire WF Report No 327804/A
	M8	1,9	0,95	0,65	0,5	
	M10	3,2	1,6	1,1	0,85	
IDMS/IDMR 	Tested with Tektalan-slabs classification according to DIN EN 13 502-2:2003 for REI 90 and RE 90 recommended				IBMB Braunschweig PB 3136/2315	

Anchor / fastener	Size	Max. loading (kN) for specified fire resistance time (fire resistance time in minutes)				Authority / No.
		F30	F60	F90	F120	
HVZ + HAS-TZ 	M10	4,5	2,2	1,3	1,0	IBMB Braunschweig UB 3357/0550-1 Warringtonfire WF Report No 327804/B
	M12	10,0	3,5	1,8	1,2	
	M16	15,0	7,0	4,0	3,0	
	M20	25,0	9,0	7,0	5,0	
HVZ + HAS-R/HAS-HCR-TZ 	M10	10,0	4,5	2,7	1,7	Warringtonfire WF Report No 327804/B
	M12	15,0	7,5	4,0	3,0	
	M16	20,0	11,5	7,5	6,0	
	M20	35,0	18,0	11,5	9,0	
HVU + HAS 	M8	1,5	0,8	0,5	0,4	IBMB Braunschweig UB- 3333/0891-1 Warringtonfire WF Report No 327804/B
	M10	4,5	2,2	1,3	0,9	
	M12	10,0	3,5	1,8	1,0	
	M16	15,0	5,0	4,0	3,0	
	M20	25,0	9,0	7,0	5,0	
	M24	35,0	12,0	9,5	8,0	
	M27	40,0	13,5	11,0	9,0	
	M30	50,0	17,0	14,0	11,0	
	M33	60,0	20,0	16,5	13,5	
	M36	70,0	24,0	19,5	16,0	
	M39	85,0	29,0	23,5	19,5	
HVU + HAS-R/HAS-E-R + HVU + HAS-HCR/HAS-E-HCR 	M8	2,0	0,8	0,5	0,4	Warringtonfire WF Report No 327804/B
	M10	6,0	3,5	1,5	1,0	
	M12	10,0	6,0	3,0	2,5	
	M16	20,0	13,5	7,5	6,0	
	M20	36,0	25,5	15,0	10,0	
	M24	56,0	38,0	24,0	16,0	
	M27	65,0	44,0	27,0	18,0	
	M30	85,0	58,0	36,0	24,0	
	M33	100,0	68,0	42,0	28,0	
	M36	120,0	82,0	51,0	34,0	
M39	140,0	96,0	60,0	40,0		
HVU + HIS-N 	M8	1,5	0,8	0,5	0,4	Warringtonfire WF Report No 327804/B
	M10	4,5	2,2	1,3	0,9	
	M12	10,0	3,5	1,8	1,0	
	M16	15,0	5,0	4,0	3,0	
	M20	25,0	9,0	7,0	5,0	
HVU + HIS-RN 	M8	10,0	5,0	1,8	1,0	Warringtonfire WF Report No 327804/B
	M10	20,0	9,0	4,0	2,0	
	M12	30,0	12,0	5,0	3,0	
	M16	50,0	15,0	7,5	6,0	
	M20	65,0	35,0	15,0	10,0	

Anchor / fastener	Size	Max. loading (kN) for specified fire resistance time (fire resistance time in minutes)				Authority / No.
		F30	F60	F90	F120	
HIT-RE 500-SD + HIT-V 	M8	2,3	1,08	0,5	0,28	MFPA Leipzig GS-III/B-07-070 Warringtonfire WF Report No 327804/B Loads for standard embedment depth, for variable embedment depth see test report.
	M10	3,7	1,9	0,96	0,59	
	M12	5,3	2,76	1,59	1,0	
	M16	10,0	5,4	3,1	1,97	
	M20	15,6	8,46	4,5	2,79	
	M24	22,5	12,19	7,0	4,4	
	M27	29,2	15,8	9,1	5,7	
	M30	35,7	19,3	11,1	7,0	
HIT-RE 500-SD + HIT-VR/HIT-V-HCR 	M8	2,42	1,08	0,5	0,28	
	M10	3,8	1,9	0,96	0,59	
	M12	6,5	4,2	2,3	1,5	
	M16	12,1	8,6	4,8	3,2	
	M20	18,8	15,9	12,2	10,5	
	M24	27,2	23,0	18,8	16,7	
	M27	35,3	29,9	24,4	21,7	
	M30	43,2	36,5	29,9	26,5	
HIT-RE 500-SD + HIS-N 	M8	2,3	1,26	0,73	0,46	MFPA Leipzig GS-III/B-07-070 Warringtonfire WF Report No 327804/B
	M10	3,7	2,0	1,15	0,73	
	M12	5,3	2,9	1,68	1,06	
	M16	10,0	5,4	3,1	1,97	
	M20	15,6	8,4	4,87	3,08	
HIT-RE 500-SD + HIS-RN 	M8	2,4	1,88	1,3	1,07	
	M10	3,8	2,98	2,1	1,69	
	M12	6,5	5,5	4,5	4,0	
	M16	12,1	10,2	8,3	7,4	
	M20	18,8	15,9	13,0	11,6	

Anchor / fastener	Size	Max. loading (kN) for specified fire resistance time (fire resistance time in minutes)				Authority / No.
		F30	F60	F90	F120	
HIT-RE 500 + HAS/HAS-E/HIT-V 	M8	2,3	1,26	0,73	0,46	IBMB Braunschweig PB 3588/4825-CM, & supplement letter 412/2008 Warringtonfire WF Report No 327804/B
	M10	3,7	2,0	1,15	0,73	
	M12	5,3	2,9	1,68	1,06	
	M16	10,0	5,4	3,1	1,97	
	M20	15,6	8,4	4,8	3,08	
	M24	22,5	12,1	7,0	4,4	
	M27	29,2	15,8	9,1	5,7	
	M30	35,7	19,3	11,1	7,0	
	M33	44,2	23,9	13,8	8,7	
	M36	58,5	31,6	18,2	11,5	
HIT-RE 500 + HAS-R/HAS-ER/ HAS-HCR/HIT-V-R/HIT-V-HCR 	M8	2,4	1,88	1,34	1,07	IBMB Braunschweig Test Report 3565 / 4595, & supplement letter 414/2008 Warringtonfire WF Report No 327804/B
	M10	3,8	2,98	2,1	1,69	
	M12	6,5	5,5	4,5	4,0	
	M16	12,1	10,2	8,3	7,4	
	M20	18,8	15,9	13,0	11,6	
	M24	27,2	23,0	18,8	16,7	
	M27	35,3	29,9	24,4	21,7	
	M30	43,2	36,5	29,9	26,5	
	M33	53,4	45,2	37,0	32,8	
	M36	70,6	59,7	48,9	43,4	
HIT-RE 500 + HIS-N 	M8	2,3	1,2	0,7	0,4	IBMB Braunschweig PB 3588/4825-CM Brunswick Warringtonfire WF Report No 327804/B
	M10	3,7	2,0	1,1	0,7	
	M12	5,3	2,9	1,68	1,06	
	M16	10,0	5,4	3,1	1,97	
	M20	15,6	8,4	4,87	3,08	
HIT-RE 500 + HIS-RN 	M8	2,3	1,2	0,7	0,4	
	M10	3,8	2,98	2,1	1,69	
	M12	6,5	5,5	4,5	4,0	
	M16	12,1	10,2	8,3	7,4	
	M20	18,9	15,9	13,0	11,6	





Anchor / fastener	Size	Max. loading (kN) for specified fire resistance time (fire resistance time in minutes)				Authority / No.
		F30	F60	F90	F120	
HIT-HY 200-A + HIT-Z 	M8	1,64	0,45	0,24	0,17	IBMB Braunschweig 3501/676/12 Loads for typical embedment depth, cracked concrete. For variable embedment depth and non-cracked concrete see test report.
	M10	2,75	0,75	0,40	0,28	
	M12	4,90	1,80	0,89	0,59	
	M16	10,5	6,07	2,95	1,83	
	M20	16,4	12,3	7,70	4,72	
HIT-HY 200-A + HIT-Z-R 	M8	1,64	0,45	0,24	0,17	Warringtonfire WF Report No 327804/B
	M10	2,75	0,75	0,40	0,28	
	M12	6,67	1,80	0,89	0,59	
	M16	20,1	6,07	2,95	1,83	
	M20	31,4	16,01	7,70	4,72	
HIT-HY 200-A + HIT-V 5.8 	M8	1,20	0,45	0,24	0,17	
	M10	2,00	0,75	0,40	0,28	
	M12	3,00	1,80	0,89	0,59	
	M16	6,20	2,55	1,29	0,86	
	M20	9,70	7,80	5,85	3,61	
	M24	14,0	11,3	8,60	7,20	
	M27	18,3	14,7	11,2	9,40	
M30	22,3	17,9	13,6	11,5		
HIT-HY 200-A + HIT-V 8.8 	M8	1,64	0,45	0,24	0,17	
	M10	2,75	0,75	0,40	0,28	
	M12	4,90	1,80	0,89	0,59	
	M16	9,09	2,55	1,29	0,86	
	M20	16,4	12,01	5,85	3,61	
	M24	23,6	17,7	11,8	8,80	
	M27	30,9	23,1	15,3	11,5	
	M30	37,6	28,1	18,7	14,0	
HIT-HY 200-A + HIT-V-R 	M8	1,64	0,45	0,24	0,17	
	M10	2,75	0,75	0,40	0,28	
	M12	6,67	1,80	0,89	0,59	
	M16	9,09	2,55	1,29	0,86	
	M20	31,4	12,01	5,85	3,61	
	M24	45,2	29,8	14,4	8,83	
	M27	30,9	23,1	15,3	11,5	
	M30	71,9	52,2	32,5	21,08	



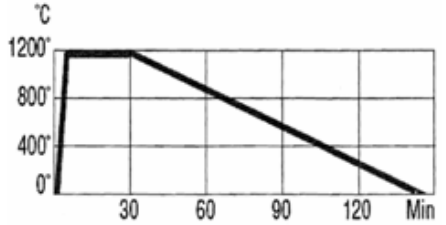

Anchor / fastener	Size	Max. loading (kN) for specified fire resistance time (fire resistance time in minutes)				Authority / No.
		F30	F60	F90	F120	
HIT-HY 70 $h_{ef} = 80$ mm (HLz, MVz, KSL, KSV) 	M8	2,0	0,4	0,2	-	MFPA Leipzig PB 3.2/12-055-1 Warringtonfire WF Report No 327804/B
	M10	2,0	0,4	0,2	-	
	M12	2,0	0,4	0,2	-	
HIT-HY 70 $h_{ef} = 130$ mm (HLz, MVz, KSL, KSV)	M8	2,0	1,2	0,7	-	
	M10	3,6	1,9	1,1	-	
	M12	5,9	3,0	1,5	-	
HIT-HY 70 $h_{ef} = 80$ mm (Autoclaved aerated concrete masonry units)	M8	2,0	0,4	0,2	-	
	M10	2,0	0,4	0,2	-	
	M12	2,0	0,4	0,2	-	
HIT-HY 70 $h_{ef} = 130$ mm (Autoclaved aerated concrete masonry units)	M8	2,0	0,8	0,6	-	
	M10	2,0	1,0	0,8	-	
	M12	2,0	1,2	1,0	-	
HIT-HY 70 $h_{ef} = 80$ and 130mm (Brick ceiling)	M6	0,7	0,4	0,2	-	

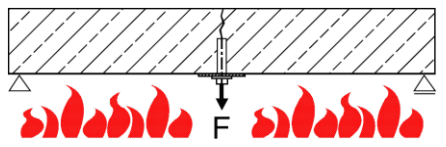

Tested fasteners for passive structural fire prevention

Tested according to the german tunnel temperature curve

MFPA Leipzig GmbH 	Tested according to the german tunnel temperature curve (ZTV-ING, part 5).	
	Tested when set in cracked concrete and exposed to flames without insulating or protective measures.	
		

Anchor / fastener	Size	Max. loading (kN) for specified fire rating/integrity	Authority/No.
	M10	1,0	IBMB Braunschweig UB 3332/0881-2-CM & supplement letter 13184/2006 Warringtonfire WF-Report No 327804/A
	M12	1,5	
	M16	2,5	
	M20	6,0	
	6	0,20 ^{a)}	MFPA Leipzig PB III/08-354 Warringtonfire WF-Report No 327804/A
	8	0,30 ^{a)}	
	10	0,50 ^{a)}	
	14	1,10 ^{a)}	
	M8	0,5	IBMB Braunschweig UB 3027/0274-4 & supplement letter 133/00-Nau- Warringtonfire WF-Report No 327804/A
	M10	0,8	
	M12	2,5	
	M16	5,0	
	M20	6,0	
	M10	1,5	IBMB Braunschweig UB 3357/0550-2 Warringtonfire WF Report No 327804/B
	M12	2,5	
	M16	6,0	
	M20	8,0	
	M8	0,5	IBMB Braunschweig UB 3333/0891-2 Warringtonfire WF Report No 327804/B
	M10	1,5	
	M12	1,5	
	M16	5,0	

a) Tested according tunnel temperature curve EBA

Corrosion

Atmospheric corrosion of anchors

Importance

Corrosion is a process that affects metals due to their exposure to atmospheric influence. A greater concern is the safety risks, where corrosion can lead to significant impairment to the functionality of the fastening systems of the structural elements.

Hilti conducts comprehensive laboratory and field based tests to assess the corrosion resistance of its products. Thanks to the in-house research and close collaboration with renowned universities and laboratories, Hilti can offer the right solutions with the suitable corrosion protection for a wide variety of environmental conditions.

Process

Corrosion is expected to occur when the material, the protection or the structural design of a metallic component do not match the requirements imposed by the surrounding environment.

To evaluate the risk of corrosion, it is essential to assess the interaction between environmental conditions, material properties, material combinations and design characteristics.

To understand this interaction, you would need to consider the following influencing factors to atmospheric corrosion:

- **Humidity:** Is a requirement for all atmospheric corrosion reactions.
- **Temperature:** The higher the temperatures, the higher rate of corrosive attack.
- **Salt:** Salt-laden air near the sea coast and the salt used for de-icing in winter accelerate corrosion.
- **Industrial pollution:** The high content of sulphur dioxide accelerates corrosive reactions.
- **Bimetallic corrosion:** Is caused by the contact of dissimilar metals (where one metal is less noble than the other).

Corrosion protection

Corrosion protection is the principle measure to mitigate these risks.

Active corrosion protection comprises the measures that directly influence the corrosion reaction, e.g. galvanic separation, resistant materials, or cathodic protection.

Passive Corrosion Protection prevents or at least decelerates corrosion through the isolation of the metal material from the corrosive agent by the application of metallic or non-metallic protective layers of coating.

For fastening and installation systems, such as anchors, screws or channel supports, the use of resistant material or a protective coating is considered to be the safest and most economical corrosion protection method.

This chapter presents a general guideline for selecting a suitable corrosion protection method for fastening systems in commonly accepted applications for given environmental conditions.

Special applications demand special attention to the corrosion protection of the metallic components. This could be for example the conditions prevailing in road tunnels, buildings with indoor swimming pools, or in chemical plants. For such specific applications, it is advisable to consult a specialist. Your local, qualified Hilti engineers will be pleased to provide you with technical support on your application.

Zinc-coated carbon steel

Zinc coated steel typically corrodes uniformly. Steel corrosion starts when the zinc protection is mostly consumed.

On duplex-coated products the zinc is further protected by an organic or inorganic coating.



Stainless steel

Stainless steel has the ability to form very thin but dense oxide layers to protect the surface against corrosion. However, in highly corrosive environments, stainless steel may suffer from pitting corrosion, which is a localised attack that significantly decreases the lifetime of stainless steel.



Selection of corrosion protection for anchors









Anchors		HSA HUS HST HIT-V	HUS-HF	HSA-F HIT-V-F	HSA-R2	HUS-HR HSA-R HST-R HIT-V-R HIT-Z-R	HST-HCR
Coating/Material		Electro galvanize	Duplex coated carbon steel	HDG/sherardized 45-50 µm	A2 AISI 304	A4 AISI 316	HCR, e.g. 1.4529
Environmental Conditions	Fastened part						
Dry indoor	Steel (zinc-coated, painted), aluminium, stainless steel	■	■	■	■	■	■
Indoor with temporary condensation	Steel (zinc-coated, painted), aluminium	-	■	■	■	■	■
	Stainless steel		-	-			
Outdoor with low pollution	Steel (zinc-coated, painted), aluminium	-	□ *	□ *	■ *	■	■
	Stainless steel		-	-			
Outdoor with moderate concentration of pollutants	Steel (zinc-coated, painted), aluminium	-	□ *	□ *	■ *	■	■
	Stainless steel		-	-			
Coastal areas	Steel (zinc-coated, painted), aluminium, stainless steel	-	-	-	-	■	■
Outdoor, areas with heavy industrial pollution	Steel (zinc-coated, painted), aluminium, stainless steel	-	-	-	-	■	■
Close proximity to roads treated with de-icing salts	Steel (zinc-coated, painted), aluminium, stainless steel	-	-	-	-	■	■
Special applications	-	Consult experts					■

- = expected lifetime of anchors made from this material is typically satisfactory in the specified environment based on the typically expected lifetime of a building. The assumed service life in ETA approvals for powder-actuated and screw fasteners is 25 years, and for concrete anchors it is 50 years.
- = a decrease in the expected lifetime of non-stainless fasteners in these atmospheres must be taken into account (≤ 25 years). Higher expected lifetime needs a specific assessment.
- = fasteners made from this material are not suitable in the specified environment. Exceptions need a specific assessment.

From a technical point of view, HDG/duplex coatings and A2/304 material are suitable for outdoor environments with certain lifetime and application restrictions. This is based on longterm experience with these materials as reflected e.g. in the corrosion rates for Zn given in the ISO 9224:2012 (corrosivity categories, C-classes), the selection table for stainless steel grades given in the national technical approval issued by the DIBt Z.30.3-6 (April 2009) or the ICC-ES evaluation reports for our KB-TZ anchors for North America (e.g. ESR-1917, May 2013). The use of those materials in outdoor environments however is currently not covered by the European Technical Approval (ETA) of anchors, where it is stated that anchors made of galvanized carbon steel or stainless steel grade A2 may only be used in structures subject to dry indoor conditions, based on an assumed working life of the anchor of 50 years.

Environment categories

Applications can be classified into various environmental categories, by taking the following factors into account:

Indoor applications	
	Dry indoor environments
	(Heated or air-conditioning areas) without condensation, e.g. office buildings, schools.
	Indoor environments with temporary condensation
	(Unheated areas without pollutant) e.g. storage sheds
Outdoor applications	
	Outdoor, rural or urban environment with low population
	Large distance (> 10 km) from the sea
	Outdoor, rural or urban environment with moderate concentration of pollutants and/or salt from sea water
	Distance from the sea 1-10 km
	Coastal areas
	Distance from sea <1 km
	Outdoor areas with heavy industrial pollution
	Close to plants < 1 km (e.g. petrochemical, coal industry)
	Close proximity to roadways threatened with de-icing salts
	Distance to roadways < 10 m
Outdoor applications	
	Special applications
	Areas with special corrosive conditions, e.g. road tunnels with de-icing salt, indoor swimming pools, special applications in the chemical industry (exceptions possible).

Important notes

The ultimate decision on the required corrosion protection must be made by the customer. Hilti accepts no responsibility regarding the suitability of a product for a specific application, even if informed of the application conditions.

The tables are based on an average service life for typical applications.

For metallic coatings, e.g. zinc layer systems, the end of lifetime is the point at which red rust is visible over a large fraction of the product and widespread structural deterioration can occur – the initial onset of rust may occur sooner.

National or international codes, standards or regulations, customer and/or industry specific guidelines must be independently considered and evaluated.

These guidelines apply to atmospheric corrosion only. Special types of corrosion, such as crevice corrosion or hydrogen assisted cracking must be independently evaluated.















The tables published in this brochure describe only a general guideline for commonly accepted applications in typical atmospheric environments.







Suitability for a specific application can be significantly affected by localised conditions, including but not limited to:

- Elevated temperatures and humidity; High levels of airborne pollutants; Direct contact with corrosive products, such as found in some types of chemically-treated wood, waste water, concrete additives, cleaning agents, etc. ;Direct contact to soil, stagnant water; Electrical current; Contact with dissimilar metals; Confined areas, e.g. crevices; Physical damage or wear; Extreme corrosion due to combined effects of different influencing factors; Enrichment of pollutants on the product

Typical examples of applications

Application	General conditions		Material	
Initial/carcass construction				
<i>Temporary fastening, maximum up to one year:</i> Forming, site fixtures, scaffolding		Outdoor and indoor applications	Electrogalvanised	
<i>Structural fastening:</i> Brackets, columns, beams		Dry indoor environments without condensation	Electrogalvanised	
		Damp inside rooms with occasional condensation due to high humidity and temperature fluctuations	Hot-dipped galvanised / sherardized min. 45 microns, A2 (304) and A4 (316) steel	
		Outdoor, rural or urban environment with low pollution. Large distance (>10km) from the sea.	Hot-dipped galvanised / sherardized min. 45 microns, A2 (304) and A4 (316) steel	
		Frequent and long-lasting condensation (greenhouses), open inside rooms or open halls/sheds	A4 (316) steel, possibly hot-dipped galvanised (depends on time of use)	
		Or Outdoor, rural or urban environment with low pollution		
	Or Coastal areas and areas with heavy industrial pollution			
Interior finishing				
<i>Drywalls, suspended ceilings, windows, doors, railings / fences, elevators, fire escapes</i>		Dry indoor environments without condensation	Electrogalvanised	
Facades / roofing				
Profiled metal sheets, curtain wall cladding, insulation fastenings, facade support framing		Outdoor, rural or urban atmosphere with low pollution	Indoor	Electrogalvanised
			Outside application	Hot-dipped galvanised / sherardized min. 45 microns, A2 (304) and A4 (316) steel
		Outdoor, rural or urban environment with moderate concentration of pollutants	Indoor	Electrogalvanised
			Outside application	Hot-dipped galvanised / sherardized min. 45 microns, A2 (304) and A4 (316) steel
		Outdoor, areas with heavy industrial pollution and (e.g. petrochemical and coal industry) or coastal areas	Indoor	Electrogalvanised
			Outside application	A4 (316) steel, Hilti HCR if chlorides and industrial pollution are combined,

Application	General conditions	Material
Installations		
Conduit installation, cable runs, air ducts <i>Electrical systems:</i> Runs, lighting, aerials <i>Industrial equipment:</i> Crane rails, barriers, conveyors, machine fastening	 Dry indoor environments without condensation	Electrogalvanised
	 Damp inside rooms with occasional condensation due to high humidity and temperature fluctuations	Hot-dipped galvanised / sherardized min. 45 microns, A2 (304) and A4 (316) steel
	 Outdoor, rural or urban environment with low pollution. Large distance (>10km) from the sea.	Hot-dipped galvanised / sherardized min. 45 microns, A2 (304) and A4 (316) steel
	 Frequent and long-lasting condensation (greenhouses), open inside rooms or open halls/sheeds Or  Outdoor, rural or urban environment with low pollution Or  Coastal areas and areas with heavy industrial pollution	A4 (316) steel, possibly hot-dipped galvanised (depends on time of use)
Dock/harbour / port facilities / off-shore rigs		
Fastenings to quaysides, dock / harbour	 Secondary relevance for safety, temporary fastenings	Electrogalvanised
	 On the platform / rig	A4 (316) steels
	 High humidity & temperature,, chlorides, often a superimposed "industrial atmosphere" or changes of oil / sea water, no whasing off	Hilti-HCR steel
Industry / chemical industry		
Conduit installation, cable runs, connecting structures, lighting	 Dry indoor environments without condensation	Electrogalvanised
	 Corrosive inside rooms, e.g. fastenings in laboratories, galvanising / plating plants etc., very corrosive vapours	A4 (316) steel, Hilti-HCR
	 Outside applications, very heavy exposure to SO ₂ and additional corrosive substances	A4 (316) steel, Hilti-HCR
Sewage / waste water treatment		
Conduit installation, cable runs, connecting structures etc	 In the atmosphere, high humidity, sewage / digester gases etc.	A4 (316) steel, hot-dipped galvanised / sherardized min. 45 microns
	 Underwater applications, municipal sewage / waste water, industrial waste water	A4 (316) steel or Hilti-HCR depending on the water composition

Application	General conditions	Material	
Tunnel construction - (Check Hilti tunnel brochure)			
Tunnel foils / sheeting, reinforcing mesh, traffic signs, lighting, tunnel wall cladding / lining, air ducts, ceiling suspensions, etc.		Secondary relevance for safety	A4 (316) steel
		Highly relevant to safety	Hilti-HCR steel
Road and bridge construction			
Conduit installation, cable runs, traffic signs, noise-insulating walls, crash barriers / guard rails, connecting structures		Directly weathered (chlorides are regularly washed off)	A4 (316) steel
		Frequently heavy exposure to deicing salt, no washing off, highly relevant to safety	Hilti HCR steel
Multi-storey car parks			
Fastening of, for example, guard rails, handrails, balustrades		Large amounts of chlorides (deicing salt) carried in by vehicles, many wet and dry cycles	A4 (316) steel, Hilti-HCR
Indoor swimming pools			
Fastening of, for example, service ladders, handrails, suspended ceilings		Fastenings relevant to safety	Hilti-HCR steel
Sports grounds / facilities / stadiums			
Fastening of, for example, seats, handrails, fences		Outdoor, rural or urban atmosphere with low pollution	Hot-dipped galvanised / sherardized min. 45 microns, A2 (304) and A4 (316) steel
		Outdoor, rural or urban environment with low pollution	Hot-dipped galvanised / sherardized min. 45 microns, A2 (304) and A4 (316) steel
		Coastal areas, inaccessible fastenings	A4 (316) steel

The following table shows the suitability of the respective metal couple. It also shows which two metals in contact are permissible in field practice and which should rather be avoided.

Fastened part (Large area)	Fastener (small area)			
	Electrogalvanised	Duplex coated carbon steel	Hot-dipped galvanised	Stainless steel
Electrogalvanised	<input type="checkbox"/>	<input type="checkbox"/>	<input type="checkbox"/>	<input type="checkbox"/>
Hot-dipped galvanised	<input type="checkbox"/>	<input type="checkbox"/>	<input type="checkbox"/>	<input type="checkbox"/>
Aluminium	■	■	■	<input type="checkbox"/>
Structural or cast steel	■	■	■	<input type="checkbox"/>
Stainless steel (CrNi or CrNiMo)	■	■	■	<input type="checkbox"/>
Tin	■	■	■	<input type="checkbox"/>
Copper	■	■	■	<input type="checkbox"/>
Brass	■	■	■	<input type="checkbox"/>

- Slightly or no corrosion of fastener
- Moderate corrosion of fastener, technically acceptable in many cases
- Heavy corrosion of fastener

Hilti SAFEset

SAFEset system

Hilti Innovation

Cleaning the holes after drilling is seen by contractors around the world as a tedious and time-consuming part of the chemical anchor installation process. It requires the use of inconvenient tools and equipment such as steel brushes, compressed air or manual pumps. Proper borehole cleaning is essential for reliable anchor performance; however, this step in the installation process has long been a major concern for chemical anchor users everywhere.

Contractors and engineers who design anchor points and post-installed rebar can now have greater peace of mind regarding the installation quality by specifying Hilti **SAFEset** systems. The load performance on the jobsite will be as robust as the level it has been designed for.

Hilti **SAFEset** systems are a combination of anchor system components that significantly increase the anchor's robustness and dramatically reduce potential user errors during the installation process.

The new system eliminates the need for traditional borehole cleaning and makes dustless working possible for key applications. The Hilti **SAFEset** systems are supported with an ETA approval.

This unique approach to chemical anchor installation greatly increases customer productivity by reducing the time and labor costs associated with the traditional method.

Anchoring solutions

Hilti HY 200 + HIT-Z



Drilling and installing the HIT-Z rod without borehole cleaning

HIT-Z / HY 200 system

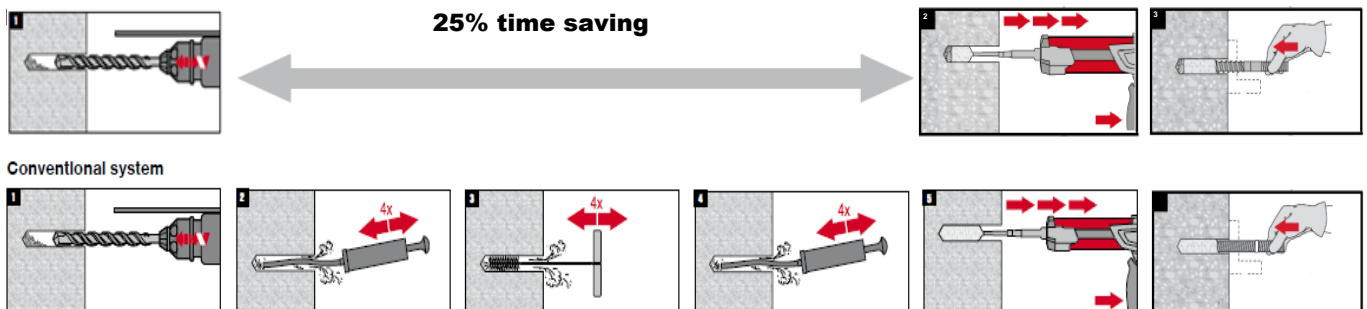

Rebar solutions

- Hilti HY 200 + TE CD-YD
- Hilti CT 1 + TE CD-YD
- Hilti RE 500 + TE CD-YD
- Hilti RE 500-SD + TE CD-YD



Drilling and borehole cleaning in one step

TE CD-YD / HY 200 system

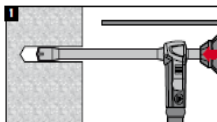

50% time saving

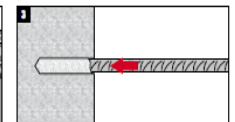
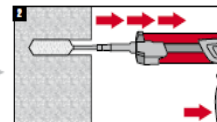

Conventional system

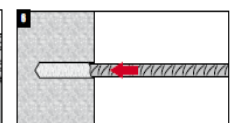
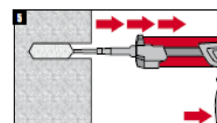
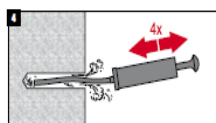
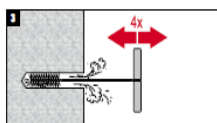
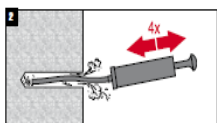
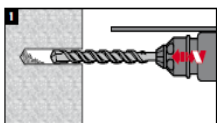

Mechanical anchoring systems

Heavy duty anchors
Medium duty anchors
Light duty anchors
Insulation fasteners



HSL-3 Heavy duty anchor, carbon steel

Anchor version		Benefits
	HSL-3 Bolt version	- suitable for non-cracked and cracked concrete C 20/25 to C 50/60 - high loading capacity - force-controlled expansion - reliable pull-down of the part fastened - no rotation in hole when tightening bolt
	HSL-3-G Threaded rod version	
	HSL-3-B Safety cap version	
	HSL-3-SH Hexagonal socked head screws	
	HSL-3-SK Countersunk version	



Concrete



Tensile zone



Seismic

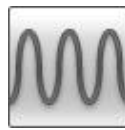

Fatigue



Shock



Fire resistance



European Technical Approval



CE conformity



PROFIS Anchor design software

Approvals / certificates

Description	Authority / Laboratory	No. / date of issue
European technical approval ^{a)}	CSTB, Paris	ETA-02/0042 / 2013-01-10
ICC-ES report incl. seismic	ICC evaluation service	ESR 1545 / 2014-02-01
Shockproof fastenings in civil defence installations	Federal Office for Civil Protection, Bern	BZS D 08-601 / 2008-06-30
Fire test report	IBMB, Braunschweig	UB 3041/1663-CM / 2004-03-22
Assessment report (fire)	warringtonfire	WF 327804/A / 2013-07-10

a) All data given in this section according ETA-02/0042, issue 2013-01-10.

Basic loading data (for a single anchor)

All data in this section applies to

- Correct setting (See setting instruction)
- No edge distance and spacing influence
- Concrete as specified in the table
- Steel failure
- Minimum base material thickness
- Concrete C 20/25, $f_{ck,cube} = 25 \text{ N/mm}^2$

For details see Simplified design method

Mean ultimate resistance

Anchor size	Non-cracked concrete						Cracked concrete					
	M8	M10	M12	M16	M20	M24	M8	M10	M12	M16	M20	M24
Tensile $N_{R_{u,m}}$ [kN]	31,1	39,2	47,9	66,9	93,5	122,9	15,9	21,2	34,2	47,8	66,8	87,8
Shear $V_{R_{u,m}}$												
HSL-3, HSL-3-B, HSL-3-SK ^{a)} , HSL-3-SH ^{a)} [kN]	43,0	68,0	95,8	133,8	187,0	245,3	40,0	56,0	68,4	95,6	133,6	175,6
HSL-3-G ^{b)} [kN]	36,1	48,1	75,1	118,5	187,0	-	36,1	48,1	68,4	95,6	133,6	-

Characteristic resistance

Anchor size	Non-cracked concrete						Cracked concrete					
	M8	M10	M12	M16	M20	M24	M8	M10	M12	M16	M20	M24
Tensile N_{R_k} [kN]	23,4	29,5	36,1	50,4	70,4	92,6	12,0	16,0	25,8	36,0	50,3	66,1
Shear V_{R_k}												
HSL-3, HSL-3-B, HSL-3-SK ^{a)} , HSL-3-SH ^{a)} [kN]	31,1	49,2	71,7	100,8	140,9	177,4	30,1	42,2	51,5	72,0	100,6	132,3
HSL-3-G ^{b)} [kN]	26,1	34,8	54,3	85,7	140,9	-	26,1	34,8	51,5	72,0	100,6	-

Design resistance

Anchor size	Non-cracked concrete						Cracked concrete					
	M8	M10	M12	M16	M20	M24	M8	M10	M12	M16	M20	M24
Tensile N_{R_d} [kN]	15,6	19,7	24,0	33,6	47,0	61,7	6,7	10,7	17,2	24,0	33,5	44,1
Shear V_{R_d}												
HSL-3, HSL-3-B, HSL-3-SK ^{a)} , HSL-3-SH ^{a)} [kN]	24,9	39,4	48,1	67,2	93,9	123,5	20,1	28,1	34,3	48,0	67,1	88,2
HSL-3-G ^{b)} [kN]	20,9	27,8	43,4	67,2	93,9	-	20,1	27,8	34,3	48,0	67,1	-

Recommended loads

Anchor size	Non-cracked concrete						Cracked concrete					
	M8	M10	M12	M16	M20	M24	M8	M10	M12	M16	M20	M24
Tensile $N_{rec}^{c)}$ [kN]	11,2	14,1	17,2	24,0	33,5	44,1	4,8	7,6	12,3	17,1	24,0	31,5
Shear $V_{rec}^{c)}$												
HSL-3, HSL-3-B, HSL-3-SK ^{a)} , HSL-3-SH ^{a)} [kN]	17,8	28,1	34,3	48,0	67,1	88,2	14,3	20,1	24,5	34,3	47,9	63,0
HSL-3-G ^{b)} [kN]	14,9	19,9	31,0	48,0	67,1	-	14,3	19,9	24,5	34,3	47,9	-

a) HSL-3-SK and HSL-3-SH is only available up to M12

b) HSL-3-G is only available up to M20

c) With overall partial safety factor for action $\gamma = 1,4$. The partial safety factors for action depend on the type of loading and shall be taken from national regulations.

Materials

Mechanical properties of HSL-3, HSL-3-G, HSL-3-B, HSL-3-SH, HSL-3-SK

Anchor size	M8	M10	M12	M16	M20	M24
Nominal tensile strength f_{uk} [N/mm ²]	800	800	800	800	830	830
Yield strength f_{yk} [N/mm ²]	640	640	640	640	640	640
Stressed cross-section A_s [mm ²]	36,6	58,0	84,3	157	245	353
Moment of resistance W [mm ³]	31,3	62,5	109,4	277,1	540,6	935,4
Design bending resistance without sleeve $M_{Rd,s}$ [Nm]	24,0	48,0	84,0	212,8	415,2	718,4

Material quality

Part	Material
Bolt, threaded rod	steel strength 8.8, galvanised to min. 5 μ m

Anchor dimensions

Dimensions of HSL-3, HSL-3-G, HSL-3-B, HSL-3-SH, HSL-3-SK

Anchor version	Thread size	t_{fix} [mm]		d_s [mm]	l_1 [mm]	l_2 [mm]	l_3 [mm]	l_4 [mm]		p [mm]
		min	max					min	max	
HSL-3	M8	5	200	11,9	12	32	15,2	19	214	2
HSL-3-G	M10	5	200	14,8	14	36	17,2	23	218	3
HSL-3	M12	5	200	17,6	17	40	20	28	223	3
HSL-3-G	M16	10	200	23,6	20	54,4	24,4	34,5	224,5	4
HSL-3-B	M20	10	200	27,6	20	57	31,5	51	241	4
HSL-3	M24	10	200	31,6	22	65	39	57	247	4
HSL-3-SH	M8	5		11,9	12	32	15,2	19		2
	M10	20		14,8	14	36	17,2	38		3
	M12	25		17,6	17	40	20	48		3
HSL-3-SK	M8	10	20	11,9	12	32	15,2	18,2	28,2	2
	M10	20		14,8	14	36	17,2	32,2		3
	M12	25		17,6	17	40	20	40		3

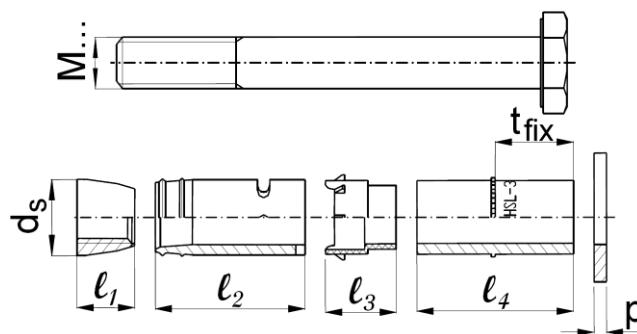

Setting

installation equipment

Anchor size	M8	M10	M12	M16	M20	M24
Rotary hammer	TE2 – TE16			TE40 – TE70		
Other tools	hammer, torque wrench, blow out pump					

Setting instruction

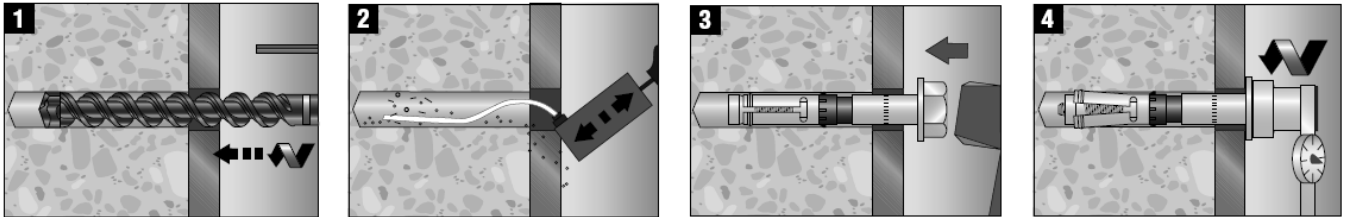

1 Drill hole.

2 Blow out dust and fragments.

3 Install anchor.

4 Apply tightening torque
(for HSL-3-B: no torque wrench is needed)

For detailed information on installation see instruction for use given with the package of the product.

For technical data for anchors in diamond drilled holes please contact the Hilti Technical advisory service.

Setting details: depth of drill hole h_1 and effective anchorage depth h_{ef}

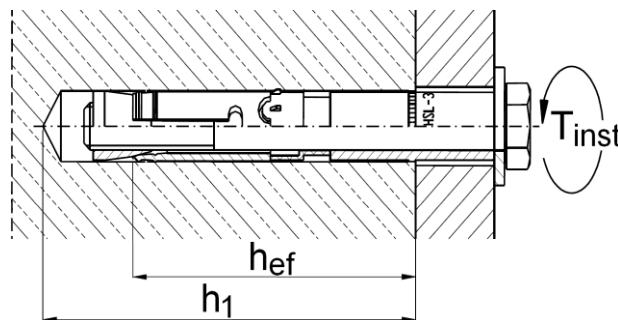

Setting details HSL-3

Anchor version HSL-3			M8	M10	M12	M16	M20	M24
Nominal diameter of drill bit	d_o	[mm]	12	15	18	24	28	32
Cutting diameter of drill bit	$d_{cut} \leq$	[mm]	12,5	15,5	18,5	24,55	28,55	32,7
Depth of drill hole	$h_1 \geq$	[mm]	80	90	105	125	155	180
Diameter of clearance hole in the fixture	$d_f \leq$	[mm]	14	17	20	26	31	35
Effective anchorage depth	h_{ef}	[mm]	60	70	80	100	125	150
Torque moment	T_{inst}	[Nm]	25	50	80	120	200	250
Width across	SW	[mm]	13	17	19	24	30	36

Setting details HSL-3-G

Anchor version HSL-3-G							
			M8	M10	M12	M16	M20
Nominal diameter of drill bit	d_o	[mm]	12	15	18	24	28
Cutting diameter of drill bit	$d_{cut} \leq$	[mm]	12,5	15,5	18,5	24,55	28,55
Depth of drill hole	$h_1 \geq$	[mm]	80	90	105	125	155
Diameter of clearance hole in the fixture	$d_f \leq$	[mm]	14	17	20	26	31
Effective anchorage depth	h_{ef}	[mm]	60	70	80	100	125
Torque moment	T_{inst}	[Nm]	20	35	60	80	160
Width across	SW	[mm]	13	17	19	24	30

Setting details HSL-3-B

Anchor version HSL-3-B						
			M12	M16	M20	M24
Nominal diameter of drill bit	d_o	[mm]	18	24	28	32
Cutting diameter of drill bit	$d_{cut} \leq$	[mm]	18,5	24,55	28,55	32,7
Depth of drill hole	$h_1 \geq$	[mm]	105	125	155	180
Diameter of clearance hole in the fixture	$d_f \leq$	[mm]	20	26	31	35
Effective anchorage depth	h_{ef}	[mm]	80	100	125	150
Width across	SW	[mm]	24	30	36	41

The torque moment is controlled by the safety cap

Setting details HSL-3-SH

Anchor version HSL-3-SH					
			M8	M10	M12
Nominal diameter of drill bit	d_o	[mm]	12	15	18
Cutting diameter of drill bit	$d_{cut} \leq$	[mm]	12,5	15,5	18,5
Depth of drill hole	$h_1 \geq$	[mm]	85	95	110
Diameter of clearance hole in the fixture	$d_f \leq$	[mm]	14	17	20
Effective anchorage depth	h_{ef}	[mm]	60	70	80
Torque moment	T_{inst}	[Nm]	25	35	60
Width across	SW	[mm]	6	8	10

Setting details HSL-3-SK

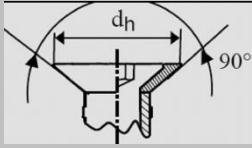
Anchor version HSL-3-SK			M8	M10	M12
Nominal diameter of drill bit	d_o	[mm]	12	15	18
Cutting diameter of drill bit	$d_{cut} \leq$	[mm]	12,5	15,5	18,5
Depth of drill hole	$h_1 \geq$	[mm]	80	90	105
Diameter of clearance hole in the fixture	$d_f \leq$	[mm]	14	17	20
Diameter of countersunk hole in the fixture	$d_h =$	[mm]	22,5	25,5	32,9
Effective anchorage depth	h_{ef}	[mm]	60	70	80
Torque moment	T_{inst}	[Nm]	25	50	80
Width across	SW	[mm]	5	6	8

Setting parameters

Anchor size			M8	M10	M12	M16	M20	M24
Minimum base material thickness	h_{min}	[mm]	120	140	160	200	250	300
	s_{min}	[mm]	60	70	80	100	125	150
Minimum spacing	for $c \geq$	[mm]	100	100	160	240	300	300
	c_{min}	[mm]	60	70	80	100	150	150
Minimum edge distance	for $s \geq$	[mm]	100	160	240	240	300	300
	$s_{cr,sp}$	[mm]	230	270	300	380	480	570
Critical spacing for splitting failure	$s_{cr,sp}$	[mm]	230	270	300	380	480	570
Critical edge distance for splitting failure	$c_{cr,sp}$	[mm]	115	135	150	190	240	285
Critical spacing for concrete cone failure	$s_{cr,N}$	[mm]	180	210	240	300	375	450
Critical edge distance for concrete cone failure	$c_{cr,N}$	[mm]	90	105	120	150	187,5	225

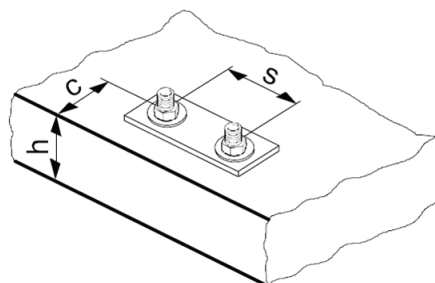

For spacing (edge distance) smaller than critical spacing (critical edge distance) the design loads have to be reduced.

Critical spacing and critical edge distance for splitting failure apply only for non-cracked concrete. For cracked concrete only the critical spacing and critical edge distance for concrete cone failure are decisive.

Simplified design method

Simplified version of the design method according ETAG 001, Annex C. Design resistance according data given in ETA-02/0042, issue 2013-01-10.

- Influence of concrete strength
- Influence of edge distance
- Influence of spacing
- Valid for a group of two anchors. (The method may also be applied for anchor groups with more than two anchors or more than one edge. The influencing factors must then be considered for each edge distance and spacing. The calculated design loads are then on the safe side: They will be lower than the exact values according ETAG 001, Annex C. To avoid this, it is recommended to use the anchor design software PROFIS anchor)

The design method is based on the following simplification:

- No different loads are acting on individual anchors (no eccentricity)

The values are valid for one anchor.

For more complex fastening applications please use the anchor design software PROFIS Anchor.

Tension loading

The design tensile resistance is the lower value of

- Steel resistance: $N_{Rd,s}$
- Concrete pull-out resistance: $N_{Rd,p} = N_{Rd,p}^0 \cdot f_B$
- Concrete cone resistance: $N_{Rd,c} = N_{Rd,c}^0 \cdot f_B \cdot f_{1,N} \cdot f_{2,N} \cdot f_{3,N} \cdot f_{re,N}$
- Concrete splitting resistance (only non-cracked concrete):
 $N_{Rd,sp} = N_{Rd,c}^0 \cdot f_B \cdot f_{1,sp} \cdot f_{2,sp} \cdot f_{3,sp} \cdot f_{h,sp} \cdot f_{re,N}$

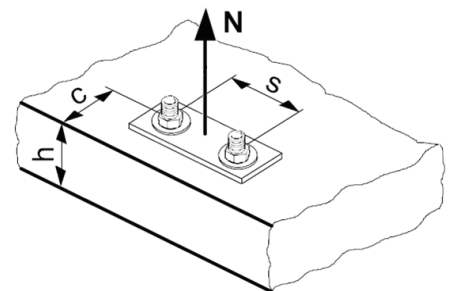

Basic design tensile resistance

Design steel resistance $N_{Rd,s}$

Anchor size		M8	M10	M12	M16	M20	M24
$N_{Rd,s}$	[kN]	19,5	30,9	44,9	83,7	130,7	188,3

Design pull-out resistance $N_{Rd,p} = N_{Rd,p}^0 \cdot f_B$ (only M8, M10 in cracked concrete)

Anchor size		Non-cracked concrete						Cracked concrete							
		M8	M10	M12	M16	M20	M24	M8	M10	M12	M16	M20	M24		
$N_{Rd,p}^0$	[kN]	No pull-out failure						6,7	10,7	No pull-out failure					

Design concrete cone resistance $N_{Rd,c} = N_{Rd,c}^0 \cdot f_B \cdot f_{1,N} \cdot f_{2,N} \cdot f_{3,N} \cdot f_{re,N}$

Design splitting resistance ^{a)} $N_{Rd,sp} = N_{Rd,c}^0 \cdot f_B \cdot f_{1,sp} \cdot f_{2,sp} \cdot f_{3,sp} \cdot f_{h,sp} \cdot f_{re,N}$

Anchor size		Non-cracked concrete						Cracked concrete					
		M8	M10	M12	M16	M20	M24	M8	M10	M12	M16	M20	M24
$N_{Rd,c}^0$	[kN]	15,6	19,7	24,0	33,6	47,0	61,7	11,2	14,1	17,2	24,0	33,5	44,1

a) Splitting resistance must only be considered for non-cracked concrete

Influencing factors

Influence of concrete strength

Concrete strength designation (ENV 206)	C 20/25	C 25/30	C 30/37	C 35/45	C 40/50	C 45/55	C 50/60
$f_B = (f_{ck,cube}/25N/mm^2)^{1/2}$ a)	1	1,1	1,22	1,34	1,41	1,48	1,55

a) $f_{ck,cube}$ = concrete compressive strength, measured on cubes with 150 mm side length

Influence of edge distance a)

$c/c_{cr,N}$	0,1	0,2	0,3	0,4	0,5	0,6	0,7	0,8	0,9	1
$c/c_{cr,sp}$										
$f_{1,N} = 0,7 + 0,3 \cdot c/c_{cr,N} \leq 1$	0,73	0,76	0,79	0,82	0,85	0,88	0,91	0,94	0,97	1
$f_{1,sp} = 0,7 + 0,3 \cdot c/c_{cr,sp} \leq 1$										
$f_{2,N} = 0,5 \cdot (1 + c/c_{cr,N}) \leq 1$	0,55	0,60	0,65	0,70	0,75	0,80	0,85	0,90	0,95	1
$f_{2,sp} = 0,5 \cdot (1 + c/c_{cr,sp}) \leq 1$										

a) The edge distance shall not be smaller than the minimum edge distance c_{min} given in the table with the setting details. These influencing factors must be considered for every edge distance.

Influence of anchor spacing a)

$s/s_{cr,N}$	0,1	0,2	0,3	0,4	0,5	0,6	0,7	0,8	0,9	1
$s/s_{cr,sp}$										
$f_{3,N} = 0,5 \cdot (1 + s/s_{cr,N}) \leq 1$	0,55	0,60	0,65	0,70	0,75	0,80	0,85	0,90	0,95	1
$f_{3,sp} = 0,5 \cdot (1 + s/s_{cr,sp}) \leq 1$										

a) The anchor spacing shall not be smaller than the minimum anchor spacing s_{min} given in the table with the setting details. This influencing factor must be considered for every anchor spacing.

Influence of base material thickness

h/h_{ef}	2,0	2,2	2,4	2,6	2,8	3,0	3,2	3,4	3,6	$\geq 3,68$
$f_{h,sp} = [h/(2 \cdot h_{ef})]^{2/3}$	1	1,07	1,13	1,19	1,25	1,31	1,37	1,42	1,48	1,5

Influence of reinforcement

Anchor size	M8	M10	M12	M16	M20	M24
$f_{re,N} = 0,5 + h_{ef}/200mm \leq 1$	0,8 ^{a)}	0,85 ^{a)}	0,9 ^{a)}	1	1	1

a) This factor applies only for dense reinforcement. If in the area of anchorage there is reinforcement with a spacing ≥ 150 mm (any diameter) or with a diameter ≤ 10 mm and a spacing ≥ 100 mm, then a factor $f_{re,N} = 1$ may be applied.

Shear loading

The design shear resistance is the lower value of

- Steel resistance: $V_{Rd,s}$
- Concrete pryout resistance: $V_{Rd,cp} = k \cdot N_{Rd,c}$
- Concrete edge resistance: $V_{Rd,c} = V_{Rd,c}^0 \cdot f_B \cdot f_h \cdot f_4 \cdot f_{hef} \cdot f_c$

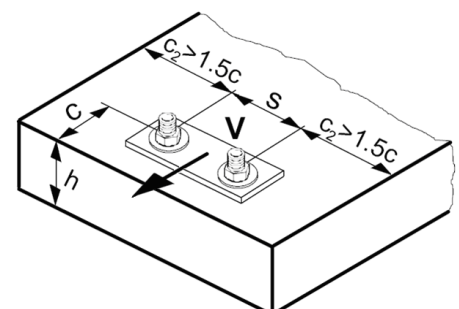

Basic design shear resistance

Design steel resistance $V_{Rd,s}$

Anchor size		M8	M10	M12	M16	M20	M24
$V_{Rd,s}$	HSL-3, HSL-3-B, HSL-3-SK ^{a)} , HSL-3-SH ^{a)} [kN]	24,9	39,4	57,4	80,9	113,5	141,9
	HSL-3-G [kN]	20,9	27,8	43,4	68,6	113,5	-

a) HSL-3-SK and HSL-3-SH is only available up to M12

Design concrete pryout resistance $V_{Rd,cp} = k \cdot N_{Rd,c}$ ^{a)}

Anchor size	M8	M10	M12	M16	M20	M24
k	1,8			2,0		

a) $N_{Rd,c}$: Design concrete cone resistance

Design concrete edge resistance^{a)} $V_{Rd,c} = V_{Rd,c}^0 \cdot f_B \cdot f_\beta \cdot f_h \cdot f_4 \cdot f_{hef} \cdot f_c$

Anchor size	Non-cracked concrete						Cracked concrete					
	M8	M10	M12	M16	M20	M24	M8	M10	M12	M16	M20	M24
$V_{Rd,c}^0$ [kN]	11,7	16,9	22,9	36,8	47,7	59,7	8,3	12,0	16,2	26,1	33,8	42,3

a) For anchor groups only the anchors close to the edge must be considered.

Influencing factors

Influence of concrete strength

Concrete strength designation (ENV 206)	C 20/25	C 25/30	C 30/37	C 35/45	C 40/50	C 45/55	C 50/60
$f_B = (f_{ck,cube}/25N/mm^2)^{1/2}$ ^{a)}	1	1,1	1,22	1,34	1,41	1,48	1,55

a) $f_{ck,cube}$ = concrete compressive strength, measured on cubes with 150 mm side length

Influence of angle between load applied and the direction perpendicular to the free edge

Angle β	0°	10°	20°	30°	40°	50°	60°	70°	80°	≥ 90°
$f_\beta = \frac{1}{\sqrt{(\cos \alpha_v)^2 + \left(\frac{\sin \alpha_v}{2,5}\right)^2}}$	1	1,01	1,05	1,13	1,24	1,40	1,64	1,97	2,32	2,50

Influence of base material thickness

h/c	0,15	0,3	0,45	0,6	0,75	0,9	1,05	1,2	1,35	≥ 1,5
$f_h = \{h/(1,5 \cdot c)\}^{1/2} \leq 1$	0,32	0,45	0,55	0,63	0,71	0,77	0,84	0,89	0,95	1,00

Influence of anchor spacing and edge distance ^{a)} for concrete edge resistance: f_4

$$f_4 = (c/h_{ef})^{1,5} \cdot (1 + s / [3 \cdot c]) \cdot 0,5$$

c/h _{ef}	Single anchor	Group of two anchors s/h _{ef}														
		0,75	1,50	2,25	3,00	3,75	4,50	5,25	6,00	6,75	7,50	8,25	9,00	9,75	10,50	11,25
0,50	0,35	0,27	0,35	0,35	0,35	0,35	0,35	0,35	0,35	0,35	0,35	0,35	0,35	0,35	0,35	0,35
0,75	0,65	0,43	0,54	0,65	0,65	0,65	0,65	0,65	0,65	0,65	0,65	0,65	0,65	0,65	0,65	0,65
1,00	1,00	0,63	0,75	0,88	1,00	1,00	1,00	1,00	1,00	1,00	1,00	1,00	1,00	1,00	1,00	1,00
1,25	1,40	0,84	0,98	1,12	1,26	1,40	1,40	1,40	1,40	1,40	1,40	1,40	1,40	1,40	1,40	1,40
1,50	1,84	1,07	1,22	1,38	1,53	1,68	1,84	1,84	1,84	1,84	1,84	1,84	1,84	1,84	1,84	1,84
1,75	2,32	1,32	1,49	1,65	1,82	1,98	2,15	2,32	2,32	2,32	2,32	2,32	2,32	2,32	2,32	2,32
2,00	2,83	1,59	1,77	1,94	2,12	2,30	2,47	2,65	2,83	2,83	2,83	2,83	2,83	2,83	2,83	2,83
2,25	3,38	1,88	2,06	2,25	2,44	2,63	2,81	3,00	3,19	3,38	3,38	3,38	3,38	3,38	3,38	3,38
2,50	3,95	2,17	2,37	2,57	2,77	2,96	3,16	3,36	3,56	3,76	3,95	3,95	3,95	3,95	3,95	3,95
2,75	4,56	2,49	2,69	2,90	3,11	3,32	3,52	3,73	3,94	4,15	4,35	4,56	4,56	4,56	4,56	4,56
3,00	5,20	2,81	3,03	3,25	3,46	3,68	3,90	4,11	4,33	4,55	4,76	4,98	5,20	5,20	5,20	5,20
3,25	5,86	3,15	3,38	3,61	3,83	4,06	4,28	4,51	4,73	4,96	5,18	5,41	5,63	5,86	5,86	5,86
3,50	6,55	3,51	3,74	3,98	4,21	4,44	4,68	4,91	5,14	5,38	5,61	5,85	6,08	6,31	6,55	6,55
3,75	7,26	3,87	4,12	4,36	4,60	4,84	5,08	5,33	5,57	5,81	6,05	6,29	6,54	6,78	7,02	7,26
4,00	8,00	4,25	4,50	4,75	5,00	5,25	5,50	5,75	6,00	6,25	6,50	6,75	7,00	7,25	7,50	7,75
4,25	8,76	4,64	4,90	5,15	5,41	5,67	5,93	6,18	6,44	6,70	6,96	7,22	7,47	7,73	7,99	8,25
4,50	9,55	5,04	5,30	5,57	5,83	6,10	6,36	6,63	6,89	7,16	7,42	7,69	7,95	8,22	8,49	8,75
4,75	10,35	5,45	5,72	5,99	6,27	6,54	6,81	7,08	7,36	7,63	7,90	8,17	8,45	8,72	8,99	9,26
5,00	11,18	5,87	6,15	6,43	6,71	6,99	7,27	7,55	7,83	8,11	8,39	8,66	8,94	9,22	9,50	9,78
5,25	12,03	6,30	6,59	6,87	7,16	7,45	7,73	8,02	8,31	8,59	8,88	9,17	9,45	9,74	10,02	10,31
5,50	12,90	6,74	7,04	7,33	7,62	7,92	8,21	8,50	8,79	9,09	9,38	9,67	9,97	10,26	10,55	10,85

a) The anchor spacing and the edge distance shall not be smaller than the minimum anchor spacing s_{min} and the minimum edge distance c_{min} .

Influence of embedment depth

Anchor size	M8	M10	M12	M16	M20	M24
$f_{hef} = 0,05 \cdot (h_{ef} / d)^{1,68}$	0,75	0,67	0,61	0,55	0,62	0,67

Influence of edge distance ^{a)}

c/d	4	6	8	10	15	20	30	40
$f_c = (d / c)^{0,19}$	0,77	0,71	0,67	0,65	0,60	0,57	0,52	0,50

a) The edge distance shall not be smaller than the minimum edge distance c_{min} .

Combined tension and shear loading

For combined tension and shear loading see section "Anchor Design".

Precalculated values

Design resistance calculated according ETAG 001, Annex C and data given in ETA-02/0042, issue 2013-01-10. All data applies to concrete C 20/25 – $f_{ck,cube} = 25 \text{ N/mm}^2$. HSL-3-SK and HSL-3-SH is only available up to M12.

Recommended loads can be calculated by dividing the design resistance by an overall partial safety factor for action $\gamma = 1,4$. The partial safety factors for action depend on the type of loading and shall be taken from national regulations.

Design resistance

Single anchor, no edge effects

Anchor size		Non-cracked concrete						Cracked concrete					
		M8	M10	M12	M16	M20	M24	M8	M10	M12	M16	M20	M24
Min. base material thickness h_{min} [mm]		120	140	160	200	250	300	120	140	160	200	250	300
	Tensile N_{Rd}												
	HSL-3, HSL-3-B, HSL-3-SK, HSL-3-SH HSL-3-G [kN]	15,6	19,7	24,0	33,6	47,0	61,7	6,7	10,7	17,2	24,0	33,5	44,1
	Shear V_{Rd}, without lever arm												
	HSL-3, HSL-3-B, HSL-3-SK, HSL-3-SH [kN]	24,9	39,4	48,1	67,2	93,9	123,5	20,1	28,1	34,3	48,0	67,1	88,2
	HSL-3-G [kN]	20,9	27,8	43,4	67,2	93,9	-	20,1	27,8	34,3	48,0	67,1	-

Single anchor, min. edge distance ($c = c_{min}$)

Anchor size		Non-cracked concrete						Cracked concrete					
		M8	M10	M12	M16	M20	M24	M8	M10	M12	M16	M20	M24
Min. base material thickness h_{min} [mm]		120	140	160	200	250	300	120	140	160	200	250	300
Min. edge distance c_{min} [mm]		60	70	80	100	125	150	60	70	80	100	125	150
	Tensile N_{Rd}												
	HSL-3, HSL-3-B, HSL-3-SK, HSL-3-SH HSL-3-G [kN]	10,2	12,8	15,9	22,0	33,9	40,4	6,7	10,5	12,9	18,0	28,4	33,1
	Shear V_{Rd}, without lever arm												
	HSL-3, HSL-3-B, HSL-3-SK, HSL-3-SH [kN]	6,4	8,4	10,6	15,5	28,1	30,0	4,5	5,9	7,5	11,0	19,9	21,3
	HSL-3-G [kN]												

Double anchor, no edge effects, min. spacing ($s = s_{min}$), (load values are valid for one anchor)

Anchor size		Non-cracked concrete						Cracked concrete					
		M8	M10	M12	M16	M20	M24	M8	M10	M12	M16	M20	M24
Min. base material thickness h_{min} [mm]		120	140	160	200	250	300	120	140	160	200	250	300
Min. spacing s_{min} [mm]		60	70	80	100	125	150	60	70	80	100	125	150
	Tensile N_{Rd}												
	HSL-3, HSL-3-B, HSL-3-SK, HSL-3-SH HSL-3-G [kN]	9,8	12,4	15,2	21,2	29,6	39,0	6,7	9,4	11,4	16,0	22,4	29,4
	Shear V_{Rd}, without lever arm												
	HSL-3, HSL-3-B, HSL-3-SK, HSL-3-SH [kN]	18,7	26,2	32,1	44,8	62,6	82,3	13,4	18,7	22,9	32,0	44,7	58,8
	HSL-3-G [kN]												

HSL-GR Heavy duty anchor, stainless steel

Anchor version	Benefits
 <p>HSL-GR</p>	<ul style="list-style-type: none"> - suitable for non-cracked C 20/25 to C 50/60 - high loading capacity - force-controlled expansion - reliable pull-down of the part fastened - no rotation in hole when tightening bolt



Concrete



PROFIS
Anchor
design
software

Basic loading data (for a single anchor)

All data in this section applies to

- Correct setting (See setting instruction)
- No edge distance and spacing influence
- Concrete as specified in the table
- Steel failure
- Minimum base material thickness
- Concrete C 20/25, $f_{ck,cube} = 25 \text{ N/mm}^2$

For details see Simplified design method

Mean ultimate resistance

		Hilti technical data for non-cracked concrete				
Anchor size		M8	M10	M12	M16	M20
Tensile $N_{Ru,m}$	[kN]	26,9	39,2	47,9	66,9	93,5
Shear $V_{Ru,m}$	[kN]	26,3	42,0	57,8	84,0	115,5

Characteristic resistance

		Hilti technical data for non-cracked concrete				
Anchor size		M8	M10	M12	M16	M20
Tensile N_{Rk}	[kN]	23,4	29,5	36,1	50,4	70,4
Shear V_{Rk}	[kN]	25,0	40,0	55,0	80,0	110,0

Design resistance

		Hilti technical data for non-cracked concrete				
Anchor size		M8	M10	M12	M16	M20
Tensile N_{Rd}	[kN]	13,0	16,4	20,1	28,1	39,2
Shear V_{Rd}	[kN]	16,0	25,6	35,3	51,3	70,5

Recommended loads ^{a)}

		Hilti technical data for non-cracked concrete				
Anchor size		M8	M10	M12	M16	M20
Tensile N_{rec}	[kN]	9,3	11,7	14,3	20,0	28,0
Shear V_{rec}	[kN]	11,4	18,3	25,2	36,6	50,4

a) With overall partial safety factor for action $\gamma = 1,4$. The partial safety factors for action depend on the type of loading and shall be taken from national regulations.

Materials

Mechanical properties of HSL-GR

Anchor size		M8	M10	M12	M16	M20
Nominal tensile strength f_{uk}	[N/mm ²]	700	700	700	700	700
Yield strength f_{yk}	[N/mm ²]	450	450	450	450	450
Stressed cross-section A_s	[mm ²]	36,6	58,0	84,3	157	245
Moment of resistance W	[mm ³]	31,2	62,3	109,2	277,5	540,9
Design bending resistance without sleeve $M_{Rd,s}$	[Nm]	16,8	33,5	58,8	149,4	291,3

Material quality

Part	Material
Bolt, threaded rod	steel grade A4

Anchor dimensions

Dimensions of HSL-GR

Thread size	t_{fix} [mm]		d_s [mm]	l_1 [mm]	l_2 [mm]	l_3 [mm]	l_4 [mm]		p [mm]
	min	max					min	max	
M8	5	200	11,8	8,5	26	15,2	26	221	3
M10	5	200	14,8	10,8	30	17,2	29	224	4
M12	5	200	17,6	12	32	20	32	227	5
M16	10	200	23,6	18	46	24,4	43	233	5
M20	10	200	27,6	22	57	31,5	51	241	6

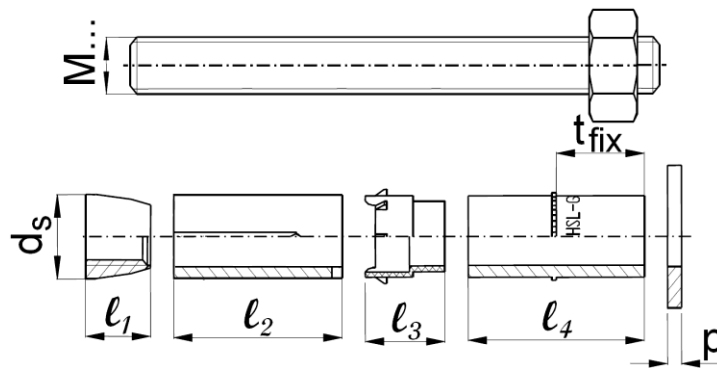

Setting

installation equipment

Anchor size	M8	M10	M12	M16	M20
Rotary hammer	TE2 – TE16			TE40 – TE70	
Other tools	hammer, torque wrench, blow out pump				

Setting instruction

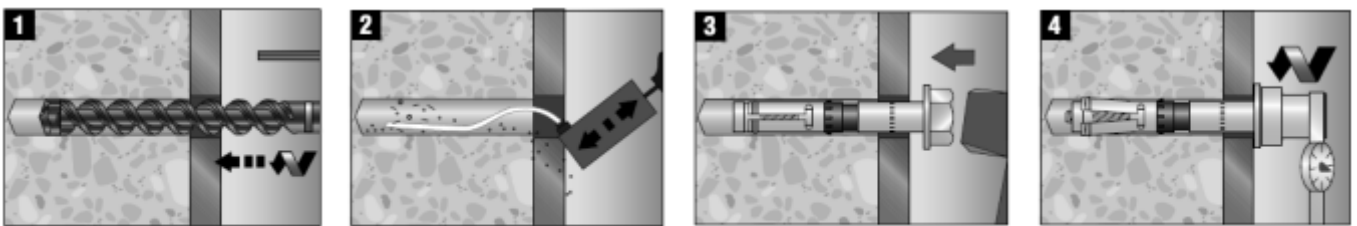

1 Drill hole.

2 Blow out dust and fragments.

3 Install anchor.

4 Apply tightening torque

For detailed information on installation see instruction for use given with the package of the product.

For technical data for anchors in diamond drilled holes please contact the Hilti Technical advisory service.

Setting details: depth of drill hole h_1 and effective anchorage depth h_{ef}

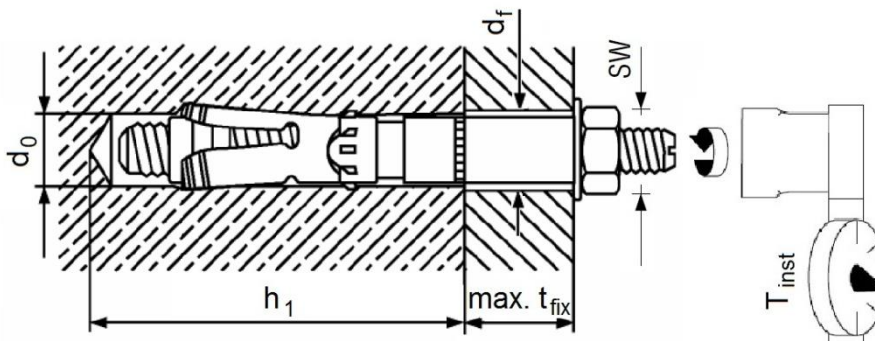

Setting details

Anchor size			M8	M10	M12	M16	M20
Nominal diameter of drill bit	d_o	[mm]	12	15	18	24	26
Cutting diameter of drill bit	$d_{cut} \leq$	[mm]	12,5	15,5	18,5	24,55	28,55
Depth of drill hole	$h_1 \geq$	[mm]	80	90	105	125	155
Diameter of clearance hole in the fixture	$d_f \leq$	[mm]	14	17	20	26	31
Effective anchorage depth	h_{ef}	[mm]	60	70	80	100	125
Torque moment	T_{inst}	[Nm]	25	50	80	120	200
Width across	SW	[mm]	13	17	19	24	30

Setting parameters

Anchor size			M8	M10	M12	M16	M20
Minimum base material thickness	h_{min}	[mm]	120	140	160	200	250
Minimum spacing	s_{min}	[mm]	100	160	240	240	300
Minimum edge distance	c_{min}	[mm]	60	70	80	100	150
Critical spacing for splitting failure	$s_{cr,sp}$	[mm]	270	300	330	380	480
Critical edge distance for splitting failure	$c_{cr,sp}$	[mm]	135	150	165	190	240
Critical spacing for concrete cone failure	$s_{cr,N}$	[mm]	180	210	240	300	375
Critical edge distance for concrete cone failure	$c_{cr,N}$	[mm]	90	105	120	150	187,5

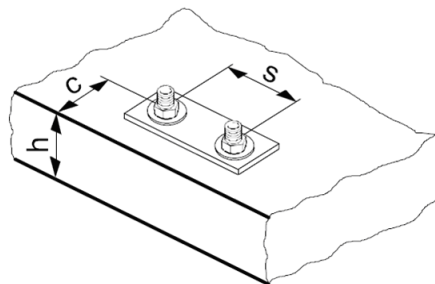

For spacing (edge distance) smaller than critical spacing (critical edge distance) the design loads have to be reduced.

Critical spacing and critical edge distance for splitting failure apply only for non-cracked concrete. For cracked concrete only the critical spacing and critical edge distance for concrete cone failure are decisive.

Simplified design method

Simplified version of the design method according ETAG 001, Annex C.

- Influence of concrete strength
- Influence of edge distance
- Influence of spacing
- Valid for a group of two anchors. (The method may also be applied for anchor groups with more than two anchors or more than one edge. The influencing factors must then be considered for each edge distance)

and spacing. The calculated design loads are then on the same side: They will be lower than the exact values according ETAG 001, Annex C.)

The design method is based on the following simplification:

- No different loads are acting on individual anchors (no eccentricity)

The values are valid for one anchor.

For more complex fastening applications please use the anchor design software PROFIS Anchor.

Tension loading

The design tensile resistance is the lower value of

- Steel resistance: $N_{Rd,s}$
- Concrete pull-out resistance: $N_{Rd,p} = N_{Rd,p}^0 \cdot f_B$
- Concrete cone resistance: $N_{Rd,c} = N_{Rd,c}^0 \cdot f_B \cdot f_{1,N} \cdot f_{2,N} \cdot f_{3,N} \cdot f_{re,N}$
- Concrete splitting resistance (only non-cracked concrete):
 $N_{Rd,sp} = N_{Rd,c}^0 \cdot f_B \cdot f_{1,sp} \cdot f_{2,sp} \cdot f_{3,sp} \cdot f_{h,sp} \cdot f_{re,N}$

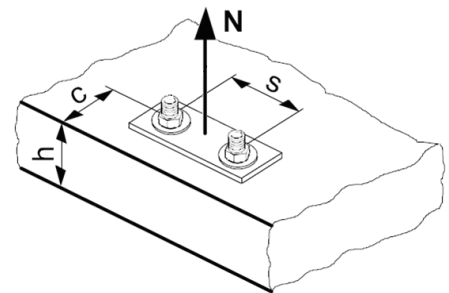

Basic design tensile resistance

Design steel resistance $N_{Rd,s}$

Anchor size	M8	M10	M12	M16	M20
$N_{Rd,s}$ [kN]	13,7	21,7	31,6	58,8	91,7

Design pull-out resistance $N_{Rd,p} = N_{Rd,p}^0 \cdot f_B$

Anchor size	M8	M10	M12	M16	M20
$N_{Rd,p}^0$ [kN]	No pull-out failure				

Design concrete cone resistance $N_{Rd,c} = N_{Rd,c}^0 \cdot f_B \cdot f_{1,N} \cdot f_{2,N} \cdot f_{3,N} \cdot f_{re,N}$

Design splitting resistance $N_{Rd,sp} = N_{Rd,c}^0 \cdot f_B \cdot f_{1,sp} \cdot f_{2,sp} \cdot f_{3,sp} \cdot f_{h,sp} \cdot f_{re,N}$

Anchor size	M8	M10	M12	M16	M20
$N_{Rd,c}^0$ [kN]	13,0	16,4	20,1	28,1	39,2

Influencing factors

Influence of concrete strength

Concrete strength designation (ENV 206)	C 20/25	C 25/30	C 30/37	C 35/45	C 40/50	C 45/55	C 50/60
$f_B = (f_{ck,cube}/25N/mm^2)^{1/2}$ a)	1	1,1	1,22	1,34	1,41	1,48	1,55

a) $f_{ck,cube}$ = concrete compressive strength, measured on cubes with 150 mm side length

Influence of edge distance ^{a)}

$c/c_{cr,N}$	0,1	0,2	0,3	0,4	0,5	0,6	0,7	0,8	0,9	1
$c/c_{cr,sp}$										
$f_{1,N} = 0,7 + 0,3 \cdot c/c_{cr,N} \leq 1$	0,73	0,76	0,79	0,82	0,85	0,88	0,91	0,94	0,97	1
$f_{1,sp} = 0,7 + 0,3 \cdot c/c_{cr,sp} \leq 1$										
$f_{2,N} = 0,5 \cdot (1 + c/c_{cr,N}) \leq 1$	0,55	0,60	0,65	0,70	0,75	0,80	0,85	0,90	0,95	1
$f_{2,sp} = 0,5 \cdot (1 + c/c_{cr,sp}) \leq 1$										

a) The edge distance shall not be smaller than the minimum edge distance c_{min} given in the table with the setting details. These influencing factors must be considered for every edge distance.

Influence of anchor spacing ^{a)}

$s/s_{cr,N}$	0,1	0,2	0,3	0,4	0,5	0,6	0,7	0,8	0,9	1
$s/s_{cr,sp}$										
$f_{3,N} = 0,5 \cdot (1 + s/s_{cr,N}) \leq 1$	0,55	0,60	0,65	0,70	0,75	0,80	0,85	0,90	0,95	1
$f_{3,sp} = 0,5 \cdot (1 + s/s_{cr,sp}) \leq 1$										

a) The anchor spacing shall not be smaller than the minimum anchor spacing s_{min} given in the table with the setting details. This influencing factor must be considered for every anchor spacing.

Influence of base material thickness

h/h_{ef}	2,0	2,2	2,4	2,6	2,8	3,0	3,2	3,4	3,6	$\geq 3,68$
$f_{h,sp} = [h/(2 \cdot h_{ef})]^{2/3}$	1	1,07	1,13	1,19	1,25	1,31	1,37	1,42	1,48	1,5

Influence of reinforcement

Anchor size	M8	M10	M12	M16	M20
$f_{re,N} = 0,5 + h_{ef}/200\text{mm} \leq 1$	0,8 ^{a)}	0,85 ^{a)}	0,9 ^{a)}	1	1

a) This factor applies only for dense reinforcement. If in the area of anchorage there is reinforcement with a spacing ≥ 150 mm (any diameter) or with a diameter ≤ 10 mm and a spacing ≥ 100 mm, then a factor $f_{re,N} = 1$ may be applied.

Shear loading

The design shear resistance is the lower value of

- Steel resistance: $V_{Rd,s}$
- Concrete pryout resistance: $V_{Rd,cp} = k \cdot N_{Rd,c}$
- Concrete edge resistance: $V_{Rd,c} = V_{Rd,c}^0 \cdot f_B \cdot f_h \cdot f_4 \cdot f_{hef} \cdot f_c$

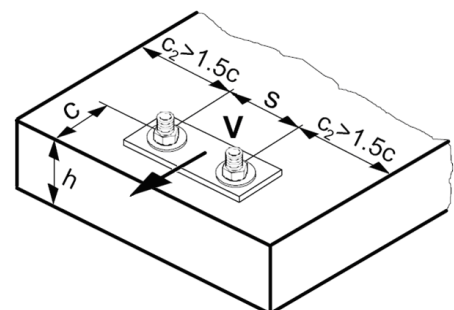

Basic design shear resistance

Design steel resistance $V_{Rd,s}$

Anchor size	M8	M10	M12	M16	M20
$V_{Rd,s}$ [kN]	16,0	25,6	35,3	51,3	70,5

Design concrete pryout resistance $V_{Rd,cp} = k \cdot N_{Rd,c}$ ^{a)}

Anchor size	M8	M10	M12	M16	M20
k	1,8	2,0			

a) $N_{Rd,c}$: Design concrete cone resistance

Design concrete edge resistance $V_{Rd,c} = V_{Rd,c}^0 \cdot f_B \cdot f_{\beta} \cdot f_h \cdot f_4 \cdot f_{hef} \cdot f_c$

Anchor size	M8	M10	M12	M16	M20
$V_{Rd,c}^0$ [kN]	11,4	16,5	22,4	36,2	46,9

a) For anchor groups only the anchors close to the edge must be considered.

Influencing factors

Influence of concrete strength

Concrete strength designation (ENV 206)	C 20/25	C 25/30	C 30/37	C 35/45	C 40/50	C 45/55	C 50/60
$f_B = (f_{ck,cube}/25N/mm^2)^{1/2}$ ^{a)}	1	1,1	1,22	1,34	1,41	1,48	1,55

a) $f_{ck,cube}$ = concrete compressive strength, measured on cubes with 150 mm side length

Influence of angle between load applied and the direction perpendicular to the free edge

Angle β	0°	10°	20°	30°	40°	50°	60°	70°	80°	≥ 90°
$f_{\beta} = \sqrt{\frac{1}{(\cos \alpha_v)^2 + \left(\frac{\sin \alpha_v}{2,5}\right)^2}}$	1	1,01	1,05	1,13	1,24	1,40	1,64	1,97	2,32	2,50

Influence of base material thickness

h/c	0,15	0,3	0,45	0,6	0,75	0,9	1,05	1,2	1,35	≥ 1,5
$f_h = \{h/(1,5 \cdot c)\}^{1/2} \leq 1$	0,32	0,45	0,55	0,63	0,71	0,77	0,84	0,89	0,95	1,00

Influence of anchor spacing and edge distance ^{a)} for concrete edge resistance: f_4

$$f_4 = (c/h_{ef})^{1,5} \cdot (1 + s / [3 \cdot c]) \cdot 0,5$$

c/h _{ef}	Single anchor	Group of two anchors s/h _{ef}														
		0,75	1,50	2,25	3,00	3,75	4,50	5,25	6,00	6,75	7,50	8,25	9,00	9,75	10,50	11,25
0,50	0,35	0,27	0,35	0,35	0,35	0,35	0,35	0,35	0,35	0,35	0,35	0,35	0,35	0,35	0,35	0,35
0,75	0,65	0,43	0,54	0,65	0,65	0,65	0,65	0,65	0,65	0,65	0,65	0,65	0,65	0,65	0,65	0,65
1,00	1,00	0,63	0,75	0,88	1,00	1,00	1,00	1,00	1,00	1,00	1,00	1,00	1,00	1,00	1,00	1,00
1,25	1,40	0,84	0,98	1,12	1,26	1,40	1,40	1,40	1,40	1,40	1,40	1,40	1,40	1,40	1,40	1,40
1,50	1,84	1,07	1,22	1,38	1,53	1,68	1,84	1,84	1,84	1,84	1,84	1,84	1,84	1,84	1,84	1,84
1,75	2,32	1,32	1,49	1,65	1,82	1,98	2,15	2,32	2,32	2,32	2,32	2,32	2,32	2,32	2,32	2,32
2,00	2,83	1,59	1,77	1,94	2,12	2,30	2,47	2,65	2,83	2,83	2,83	2,83	2,83	2,83	2,83	2,83
2,25	3,38	1,88	2,06	2,25	2,44	2,63	2,81	3,00	3,19	3,38	3,38	3,38	3,38	3,38	3,38	3,38
2,50	3,95	2,17	2,37	2,57	2,77	2,96	3,16	3,36	3,56	3,76	3,95	3,95	3,95	3,95	3,95	3,95
2,75	4,56	2,49	2,69	2,90	3,11	3,32	3,52	3,73	3,94	4,15	4,35	4,56	4,56	4,56	4,56	4,56
3,00	5,20	2,81	3,03	3,25	3,46	3,68	3,90	4,11	4,33	4,55	4,76	4,98	5,20	5,20	5,20	5,20
3,25	5,86	3,15	3,38	3,61	3,83	4,06	4,28	4,51	4,73	4,96	5,18	5,41	5,63	5,86	5,86	5,86
3,50	6,55	3,51	3,74	3,98	4,21	4,44	4,68	4,91	5,14	5,38	5,61	5,85	6,08	6,31	6,55	6,55
3,75	7,26	3,87	4,12	4,36	4,60	4,84	5,08	5,33	5,57	5,81	6,05	6,29	6,54	6,78	7,02	7,26
4,00	8,00	4,25	4,50	4,75	5,00	5,25	5,50	5,75	6,00	6,25	6,50	6,75	7,00	7,25	7,50	7,75
4,25	8,76	4,64	4,90	5,15	5,41	5,67	5,93	6,18	6,44	6,70	6,96	7,22	7,47	7,73	7,99	8,25
4,50	9,55	5,04	5,30	5,57	5,83	6,10	6,36	6,63	6,89	7,16	7,42	7,69	7,95	8,22	8,49	8,75
4,75	10,35	5,45	5,72	5,99	6,27	6,54	6,81	7,08	7,36	7,63	7,90	8,17	8,45	8,72	8,99	9,26
5,00	11,18	5,87	6,15	6,43	6,71	6,99	7,27	7,55	7,83	8,11	8,39	8,66	8,94	9,22	9,50	9,78
5,25	12,03	6,30	6,59	6,87	7,16	7,45	7,73	8,02	8,31	8,59	8,88	9,17	9,45	9,74	10,02	10,31
5,50	12,90	6,74	7,04	7,33	7,62	7,92	8,21	8,50	8,79	9,09	9,38	9,67	9,97	10,26	10,55	10,85

a) The anchor spacing and the edge distance shall not be smaller than the minimum anchor spacing s_{min} and the minimum edge distance c_{min} .

Influence of embedment depth

Anchor size	M8	M10	M12	M16	M20
$f_{hef} = 0,05 \cdot (h_{ef} / d)^{1,68}$	0,75	0,67	0,61	0,55	0,62

Influence of edge distance ^{a)}

c/d	4	6	8	10	15	20	30	40
$f_c = (d / c)^{0,19}$	0,77	0,71	0,67	0,65	0,60	0,57	0,52	0,50

a) The edge distance shall not be smaller than the minimum edge distance c_{min} .

Combined tension and shear loading

For combined tension and shear loading see section "Anchor Design".

Precalculated values

Recommended loads can be calculated by dividing the design resistance by an overall partial safety factor for action $\gamma = 1,4$. The partial safety factors for action γ depend on the type of loading and shall be taken from national regulations.

Design resistance

Single anchor, no edge effects

Anchor size		M8	M10	M12	M16	M20
Min. base material thickness h_{min} [mm]		120	140	160	200	250
	Tensile N_{Rd}					
	HSL-GR [kN]	13,0	16,4	20,1	28,1	39,2
	Shear V_{Rd}, without lever arm					
	HSL-GR [kN]	16,0	25,6	35,3	51,3	70,5

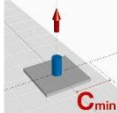
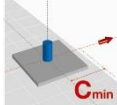

Single anchor, min. edge distance ($c = c_{min}$)

Anchor size		M8	M10	M12	M16	M20
Min. base material thickness h_{min} [mm]		120	140	160	200	250
Min. edge distance c_{min} [mm]		60	70	80	100	125
	Tensile N_{Rd}					
	HSL-GR [kN]	7,8	10,1	12,6	18,4	28,3
	Shear V_{Rd}, without lever arm					
	HSL-GR [kN]	6,4	8,4	10,6	15,5	28,1

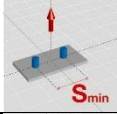
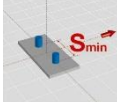
Double anchor, no edge effects, min. spacing ($s = s_{min}$), (load values are valid for one anchor)

Anchor size		M8	M10	M12	M16	M20
Min. base material thickness h_{min} [mm]		120	140	160	200	250
Min. spacing s_{min} [mm]		100	160	240	240	300
	Tensile N_{Rd}					
	HSL-GR [kN]	8,9	12,6	17,3	22,9	31,9
	Shear V_{Rd}, without lever arm					
	HSL-GR [kN]	16,0	25,6	35,3	51,3	70,5

HDA Design anchor

Anchor version		Benefits
 <p>HDA-P HDA-PR HDA-PF Anchor for pre-setting</p>	 <p>HDA-T HDA-TR HDA-TF Anchor for through-fastening</p>	<ul style="list-style-type: none"> - suitable for non-cracked and cracked concrete C 20/25 to C 50/60 - mechanical interlock (undercut) - low expansion force (thus small edge distance / spacing) - automatic undercutting (without special undercutting tool) - high loading capacity, performance of a headed stud - complete system (anchor, stop drill bit, setting tool, drill hammer) - setting mark on anchor for control (easy and safe) - completely removable - test reports: fire resistance, fatigue, shock, seismic



Concrete



Tensile zone



Seismic

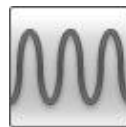

Fatigue



Shock

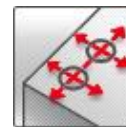

Small edge distance and spacing



Performance of a headed stud



Fire resistance

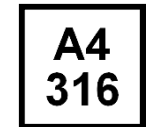

Corrosion resistance



Nuclear power plant approval



European Technical Approval



CE conformity



PROFIS Anchor design software

Approvals / certificates

Description	Authority / Laboratory	No. / date of issue
European technical approval ^{a)}	CSTB, Paris	ETA-99/0009 / 2013-03-25
ICC-ES report incl. seismic	ICC evaluation service	ESR 1546 / 2014-02-01
Shockproof fastenings in civil defence installations	Federal Office for Civil Protection, Bern	BZS D 09-601/ 2009-10-21
Nuclear power plants	DIBt, Berlin	Z-21.1-1987 / 2014-07-22
Fatigue loading	DIBt, Berlin	Z-21.1-1693 / 2013-07-29
Fire test report	IBMB, Braunschweig	UB 3039/8151-CM / 2001-01-31
Assessment report (fire)	warringtonfire	WF 327804/A / 2013-07-10

a) All data for HDA-P(R) and HDA-T(R) given in this section according ETA-99/0009, issue 2013-03-25. Sherardized versions HDA-PF and HDA-TF anchors are not covered by the approvals.

Basic loading data (for a single anchor)

All data in this section applies to

- Correct setting (See setting instruction)
- No edge distance and spacing influence
- Concrete as specified in the table
- Steel failure
- Minimum base material thickness
- Concrete C 20/25, $f_{ck,cube} = 25 \text{ N/mm}^2$

For details see Simplified design method

Mean ultimate resistance

Anchor size	Non-cracked concrete				Cracked concrete			
	M10	M12	M16	M20 ^{a)}	M10	M12	M16	M20 ^{a)}
Tensile $N_{Ru,m}$								
HDA-P(F), HDA-T(F) ^{b)} [kN]	48,7	70,9	133,3	203,2	33,3	46,7	100	126,7
HDA-PR, HDA-TR [kN]	48,7	70,9	133,3	203,2	33,3	46,7	100	126,7
Shear $V_{Ru,m}$								
HDA-P, HDA-PF ^{b)} [kN]	23,3	31,7	65,6	97,4	23,3	31,7	65,6	97,4
HDA-PR [kN]	24,3	36,0	66,7	-	24,3	36,0	66,7	-
HDA-T, HDA-TF ^{b) c)} [kN]	68,8	84,7	148,2	216,9	68,8	84,7	148,2	216,9
HDA-TR ^{c)} [kN]	75,1	92,1	160,9	-	75,1	92,1	160,9	-

a) HDA M20: only a galvanized 5 μ m version is available

b) HDA-PF and HDA-TF anchors are not covered by ETA-99/0009

c) Values are valid for minimum thickness of the base plate $t_{fix,min}$ without use of centering washer (see setting details)

Characteristic resistance

Anchor size	Non-cracked concrete				Cracked concrete			
	M10	M12	M16	M20 ^{a)}	M10	M12	M16	M20 ^{a)}
Tensile N_{Rk}								
HDA-P(F), HDA-T(F) ^{b)} [kN]	46	67	126	192	25	35	75	95
HDA-PR, HDA-TR [kN]	46	67	126	-	25	35	75	-

Anchor size	Non-cracked and cracked concrete															
	M10		M12		M16		M20 ^{a)}		M10		M12		M16		M20 ^{a)}	
Shear V_{Rk}																
HDA-P, HDA-PF ^{b)} [kN]	22		30		62		92									
HDA-PR	23		34		63		-									
for t_{fix}	[mm]	10 \leq	15 \leq	10 \leq	15 \leq	20 \leq	15 \leq	20 \leq	25 \leq	30 \leq	35 \leq	20 \leq	25 \leq	40 \leq	55 \leq	
	[mm]	<15	\leq 20	<15	<20	\leq 50	<20	<25	<30	<35	\leq 60	<25	<40	<55	\leq 100	
HDA-T, HDA-TF ^{b)} [kN]	65 ^{c)}	65	80 ^{c)}	80	100	140 ^{c)}	140	155	170	190	205 ^{c)}	205	235	250		
for t_{fix}	[mm]	10 \leq	15 \leq	10 \leq	15 \leq	20 \leq	30 \leq	20 \leq	25 \leq	30 \leq	35 \leq					-
	[mm]	<15	\leq 20	<15	<20	<30	\leq 50	<25	<30	<35	\leq 60					-
HDA-TR [kN]	71 ^{c)}	71	87 ^{c)}	87	94	109	152 ^{c)}	152	158	170					-	

a) HDA M20: only a galvanized 5 μ m version is available

b) HDA-PF and HDA-TF anchors are not covered by ETA-99/0009

c) With use of centering washer ($t = 5 \text{ mm}$) only

Design resistance

Anchor size	Non-cracked concrete				Cracked concrete			
	M10	M12	M16	M20 ^{a)}	M10	M12	M16	M20 ^{a)}
Tensile N_{Rd}								
HDA-P(F), HDA-T(F) ^{b)} [kN]	30,7	44,7	84,0	128,0	16,7	23,3	50,0	63,3
HDA-PR, HDA-TR [kN]	28,8	41,9	78,8	-	16,7	23,3	50,0	-

Anchor size	Non-cracked and cracked concrete															
	M10		M12				M16				M20 ^{a)}					
Shear V_{Rd}																
HDA-P, HDA-PF ^{b)} [kN]	17,6		24,0				49,6				73,6					
HDA-PR	17,3		25,6				47,4				-					
for t_{fix}	[mm]	10≤	15≤	10≤	15≤	20≤	15≤	20≤	25≤	30≤	35≤	20≤	25≤	40≤	55≤	
	[mm]	<15	≤20	<15	<20	≤50	<20	<25	<30	<35	≤60	<25	<40	<55	≤100	
HDA-T, HDA-TF ^{b)} [kN]	43 ^{c)}	43	53 ^{c)}	53	67	93 ^{c)}	93	103	113	127	137 ^{c)}	137	157	167		
for t_{fix}	[mm]	10≤	15≤	10≤	15≤	20≤	30≤	20≤	25≤	30≤	35≤	-				
	[mm]	<15	≤20	<15	<20	<30	≤50	<25	<30	<35	≤60	-				
HDA-TR [kN]	53 ^{c)}	53	65 ^{c)}	65	71	82	114 ^{c)}	114	119	128	-					

a) HDA M20: only a galvanized 5 μ m version is available

b) HDA-PF and HDA-TF anchors are not covered by ETA-99/0009

c) With use of centering washer ($t = 5$ mm) only

Recommended loads

Anchor size	Non-cracked concrete				Cracked concrete			
	M10	M12	M16	M20 ^{a)}	M10	M12	M16	M20 ^{a)}
Tensile N_{Rec} ^{b)}								
HDA-P(F), HDA-T(F) ^{c)} [kN]	21,9	31,9	60,0	91,4	11,9	16,7	35,7	45,2
HDA-PR, HDA-TR [kN]	20,5	29,9	56,3	-	11,9	16,7	35,7	-

Anchor size	Non-cracked and cracked concrete															
	M10		M12				M16				M20 ^{a)}					
Shear V_{Rec} ^{b)}																
HDA-P, HDA-PF ^{c)} [kN]	12,6		17,1				35,4				52,6					
HDA-PR	12,3		18,2				33,8				-					
for t_{fix}	[mm]	10≤	15≤	10≤	15≤	20≤	15≤	20≤	25≤	30≤	35≤	20≤	25≤	40≤	55≤	
	[mm]	<15	≤20	<15	<20	≤50	<20	<25	<30	<35	≤60	<25	<40	<55	≤100	
HDA-T, HDA-TF ^{c)} [kN]	31 ^{d)}	31	38 ^{d)}	38	48	67 ^{d)}	67	74	81	90	98 ^{d)}	98	112	119		
for t_{fix}	[mm]	10≤	15≤	10≤	15≤	20≤	30≤	20≤	25≤	30≤	35≤	-				
	[mm]	<15	≤20	<15	<20	<30	≤50	<25	<30	<35	≤60	-				
HDA-TR [kN]	38 ^{d)}	38	47 ^{d)}	47	50	59	82 ^{d)}	82	85	91	-					

a) HDA M20: only a galvanized 5 μ m version is available

b) With overall partial safety factor for action $\gamma_F = 1,4$. The partial safety factors for action depend on the type of loading and shall be taken from national regulations.

c) HDA-PF and HDA-TF anchors are not covered by ETA-99/0009

d) With use of centering washer ($t = 5$ mm) only

Materials

Mechanical properties of HDA

Anchor size	HDA-P(F), HDA-T(F)				HDA-PR, HDA-TR		
	M10	M12	M16	M20 ^{a)}	M10	M12	M16
Anchor bolt							
Nominal tensile strength f_{uk} [N/mm ²]	800	800	800	800	800	800	800
Yield strength f_{yk} [N/mm ²]	640	640	640	640	600	600	600
Stressed cross-section A_s [mm ²]	58,0	84,3	157	245	58,0	84,3	157
Moment of resistance W_{el} [mm ³]	62,3	109,2	277,5	540,9	62,3	109,2	277,5
Characteristic bending resistance without sleeve [Nm] $M_{Rk,s}^0$ ^{b)}	60	105	266	519	60	105	266
Anchor sleeve							
Nominal tensile strength f_{uk} [N/mm ²]	850	850	700	550	850	850	700
Yield strength f_{yk} [N/mm ²]	600	600	600	450	600	600	600

a) HDA M20: only a galvanized 5µm version is available

b) The recommended bending moment of the HDA anchor bolt may be calculated from $M_{rec} = M_{Rd,s} / \gamma_F = M_{Rk,s} / (\gamma_{MS} \cdot \gamma_F) = (1,2 \cdot W_{el} \cdot f_{uk}) / (\gamma_{MS} \cdot \gamma_F)$, where the partial safety factor for bolts of strength 8.8 is $\gamma_{MS} = 1,25$, for A4-80 equal to 1,33 and the partial safety factor for action may be taken as $\gamma_F = 1,4$. In case of HDA-T/TR/TF the bending capacity of the sleeve is neglected, only the capacity of the bolt is taken into account.

Material quality

Part	Material
HDA-P / HDA-T (Carbon steel version)	
Sleeve:	Machined steel with brazed tungsten carbide tips, galvanised to min. 5 µm
Bolt M10 - M16:	Cold formed steel, strength 8.8, galvanised to min. 5 µm
Bolt M20:	Cone machined, rod strength 8.8, galvanised to min. 5 µm
HDA-PR / HDA-TR (Stainless steel version)	
Sleeve:	Machined stainless steel with brazed tungsten carbide tips
Bolt M10 - M16:	Cone/rod: machined stainless steel
HDA-PF / HDA-TF (Sherardized version)	
Sleeve:	Machined steel with brazed tungsten carbide tips, shearadized
Bolt M10 - M16:	Cold formed steel, strength 8.8, shearadized

Anchor dimensions

HDA-P / HDA-PR / HDA-PF

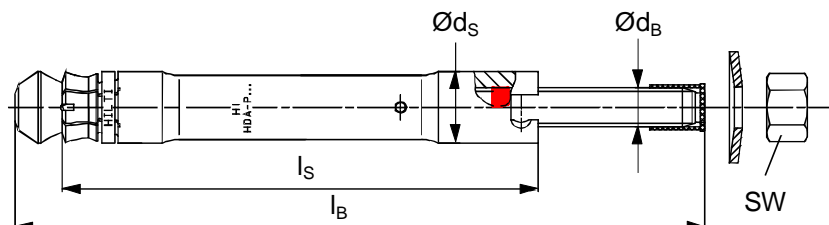

HDA-T / HDA-TR / HDA-TF

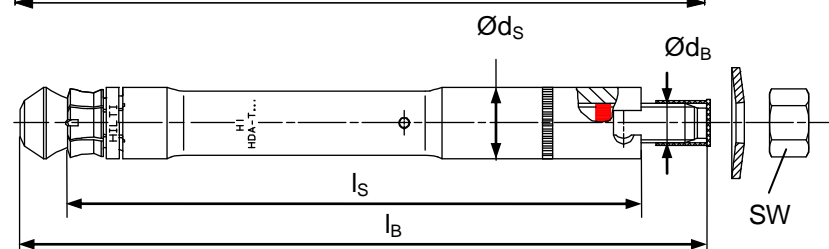

Dimensions of HDA

Anchor size	HDA-P / HDA-PR / HDA-PF / HDA-T / HDA-TR / HDA-TF						
	M10 x100/20	M12 x125/30 x125/50		M16 x190/40 x190/60		M20 x250/50 x250/100	
Length code letter	I	L	N	R	S	V	X
Total length of bolt l_B [mm]	150	190	210	275	295	360	410
Diameter of bolt d_B [mm]	10	12		16		20	
Total length of sleeve							
HDA-P l_s [mm]	100	125	125	190	190	250	250
HDA-T l_s [mm]	120	155	175	230	250	300	350
Max. diameter of sleeve d_s [mm]	19	21		29		35	
Washer diameter d_w [mm]	27,5	33,5		45,5		50	
Width across flats S_w [mm]	17	19		24		30	

Setting

Drilling



The stop drill is required for drilling in order to achieve the correct hole depth.

Anchor	Stop drill bit with TE-C (SDS plus) connection end	Stop drill bit with TE-Y (SDS max) connection end
HDA-P/ PF/ PR M10x100/20	TE-C-HDA-B 20x100	TE-Y-HDA-B 20x100
HDA-T/ TF/ TR M10x100/20	TE-C-HDA-B 20x120	TE-Y-HDA-B 20x120
HDA-P/ PF/ PR M12x125/30 HDA-P/ PF/ PR M12x125/50	TE-C HDA-B 22x125	TE-Y HDA-B 22x125
HDA-T/ TF/ TR M12x125/30	TE-C HDA-B 22x155	TE-Y HDA-B 22x155
HDA-T/ TF/ TR M12x125/50	TE-C HDA-B 22x175	TE-Y HDA-B 22x175
HDA-P/ PF/ PR M16 x190/40 HDA-P/ PF/ PR M16 x190/60		TE-Y HDA-B 30x190
HDA-T/ TF/ TR M16x190/40		TE-Y HDA-B 30x230
HDA-T/ TF/ TR M16x190/60		TE-Y HDA-B 30x250
HDA-P M20 x250/50 HDA-P M20 x250/100		TE-Y HDA-B 37x250
HDA-T M20x250/50		TE-Y HDA-B 37x300
HDA-T M20x250/100		TE-Y HDA-B 37x350

Setting

Drilling hammer



Setting tool

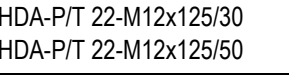
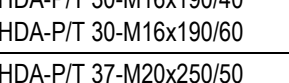

The setting system (tool and setting tool) is required for transferring the specific energy for the undercutting process.

Anchor											Setting tool
	TE 24 ^{a)} TE 25 ^{a)}	TE 35	TE 40 TE 40 AVR	TE 56 TE 56-ATC	TE 60 TE 60-ATC	TE 70 TE 70-ATC	TE 75	TE 76 TE 76-ATC	TE 80-ATC TE 80-ATC AVR		
 HDA-P/T20-M10x100/20	■		■								TE-C-HDA-ST 20 M10
				■	■						TE-Y-HDA-ST 20 M10
 HDA-P/T 22-M12x125/30 HDA-P/T 22-M12x125/50	■		■								TE-C-HDA-ST 22 M12
	■		■	■	■						TE-Y-HDA-ST 22 M12
 HDA-P/T 30-M16x190/40 HDA-P/T 30-M16x190/60						■	■	■	■		TE-Y-HDA-ST 30 M16
						■			■		TE-Y-HDA-ST 37 M20

a) 1st gear

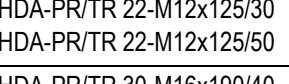
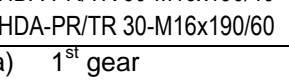
Anchor											Setting tool
	TE 24 ^{a)} TE 25 ^{a)}	TE 35	TE 40 TE 40 AVR	TE 56 TE 56-ATC	TE 60 TE 60-ATC	TE 70 TE 70-ATC	TE 75	TE 76 TE 76-ATC	TE 80-ATC TE 80-ATC AVR		
 HDA-PR/TR20-M10x100/20	■	■	■		■						TE-C-HDA-ST 20 M10
				■	■						TE-Y-HDA-ST 20 M10
 HDA-PR/TR 22-M12x125/30 HDA-PR/TR 22-M12x125/50	■	■	■	■	■						TE-C-HDA-ST 22 M12
	■	■	■	■	■						TE-Y-HDA-ST 22 M12
 HDA-PR/TR 30-M16x190/40 HDA-PR/TR 30-M16x190/60						■	■	■	■		TE-Y-HDA-ST 30 M16

a) 1st gear

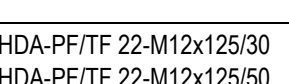
Anchor											Setting tool
	TE 24 ^{a)} TE 25 ^{a)}	TE 35	TE 40 TE 40 AVR	TE 56 TE 56-ATC	TE 60 TE 60-ATC	TE 70 TE 70-ATC	TE 75	TE 76 TE 76-ATC	TE 80-ATC TE 80-ATC AVR		
 HDA-PF/TF 20-M10x100/20		■	■		■						TE-C-HDA-ST 20 M10
		■	■		■						TE-C-HDA-ST 22 M12
 HDA-PF/TF 30-M16x190/40 HDA-PF/TF 30-M16x190/60						■	■	■	■		TE-Y-HDA-ST 30 M16

a) 1st gear

Setting instruction

HDA-P, HDA-PR, HDA-PF

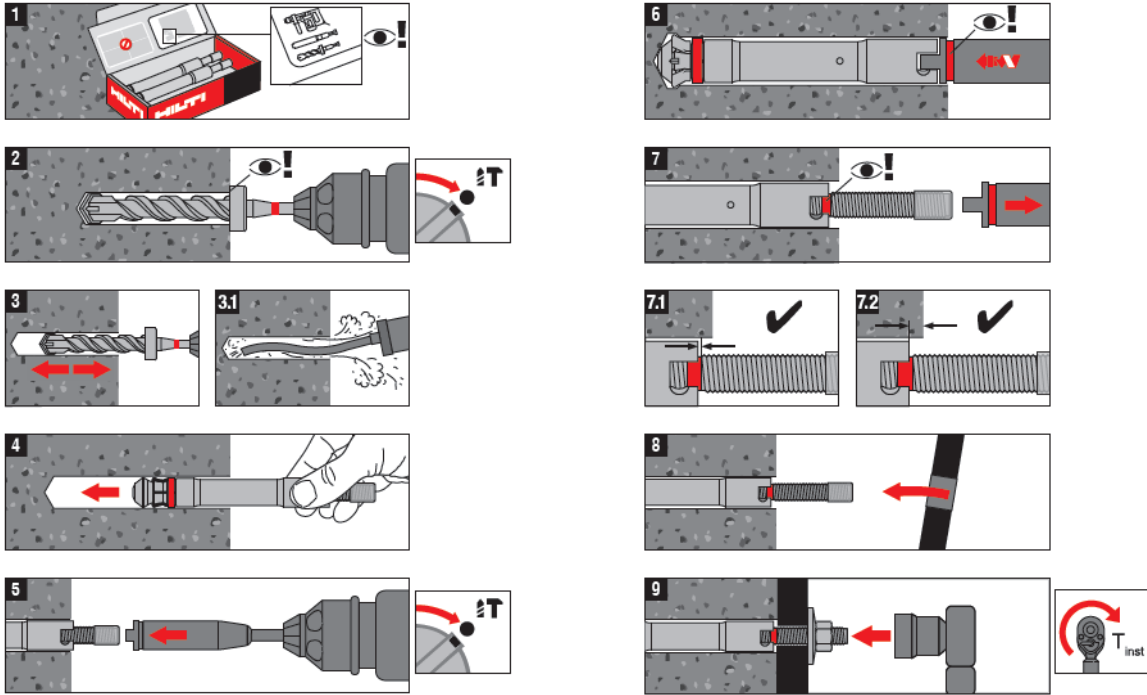

209616-A /05.07

HDA-T, HDA-TR, HDA-TF

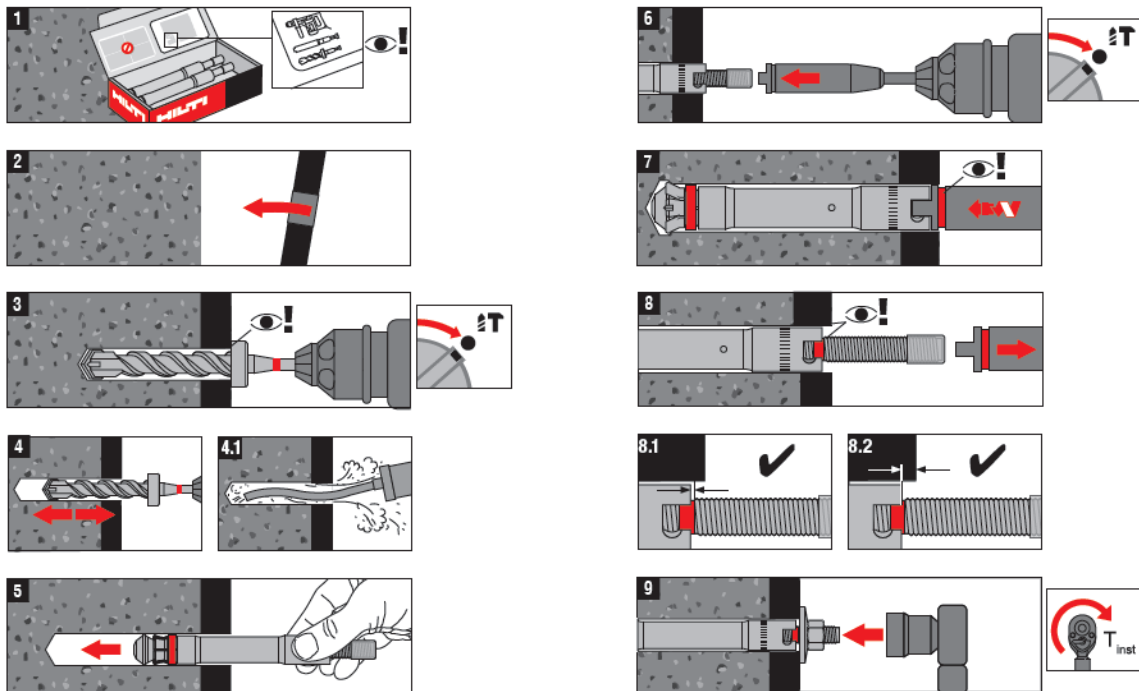

209617-A /05.07

HDA-F-CW, HDA-R-CW (to be set with HDA-T, HDA-TF, HDA-TR)

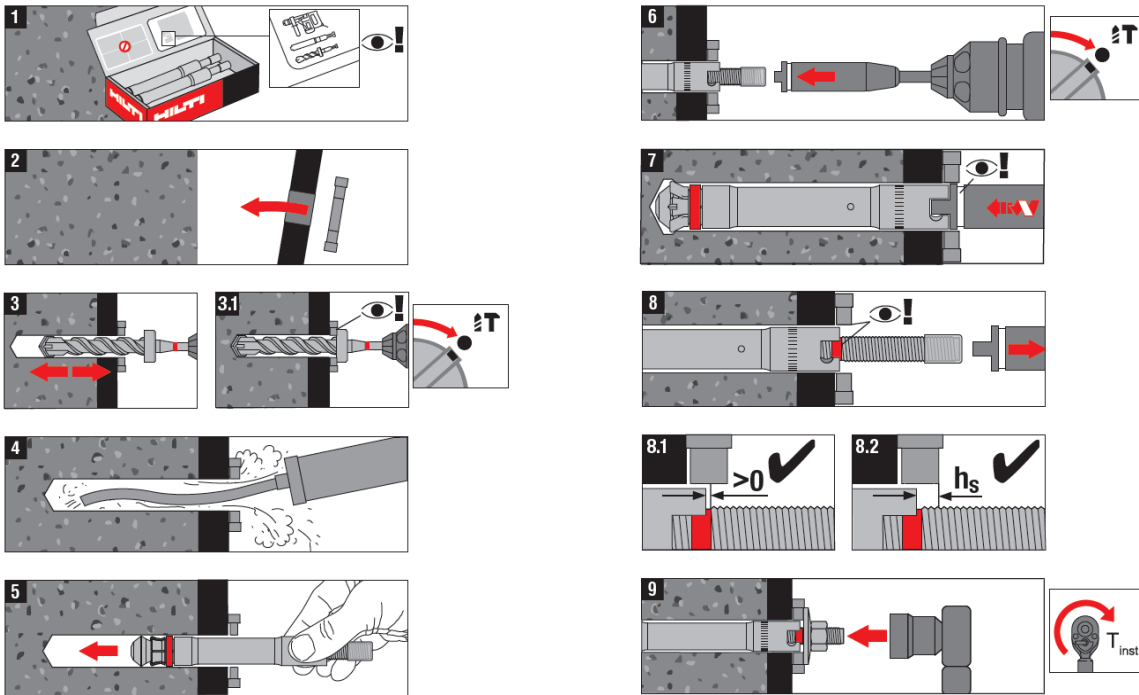

230285-A/11.07

For detailed information on installation see instruction for use given with the package of the product.

Setting details

HDA-P / HDA-PR / HDA-PF

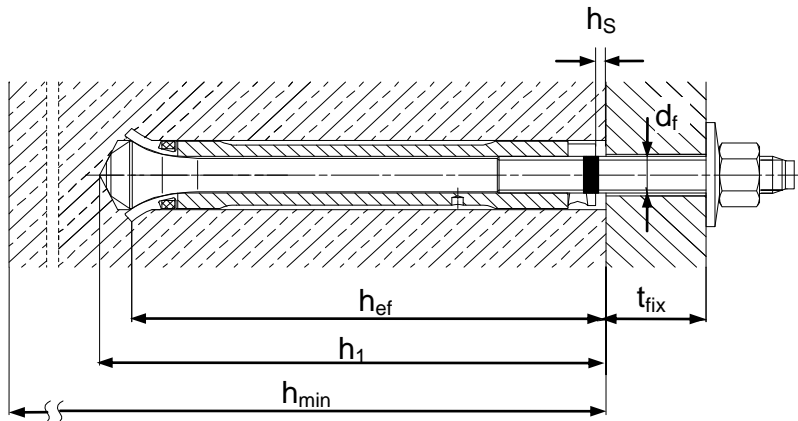

HDA-T / HDA-TR / HDA-TF

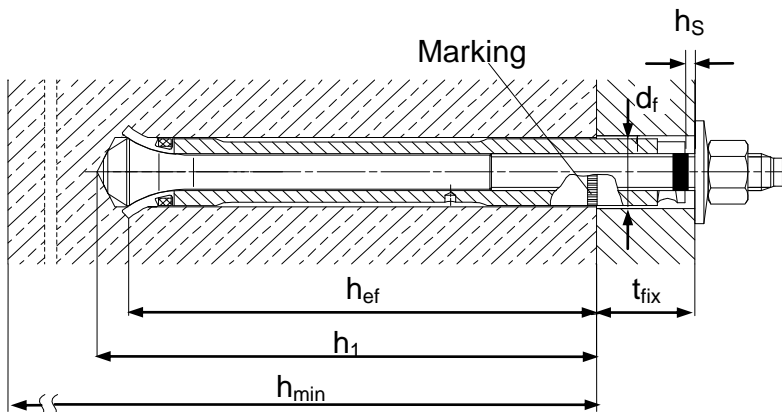

Anchor size	HDA-P / HDA-PR / HDA-PF / HDA-T / HDA-TR / HDA-TF							
	M10 x100/20	M12 x125/30 x125/50		M16 x190/40 x190/60		M20 x250/50 x250/100		
Head marking	I	L	N	R	S	V	X	
Nominal drill bit diameter	d_0 [mm]	20	22	30	37			
Cutting diameter of drill bit	$d_{cut,min}$ [mm]	20,10	22,10	30,10	37,15			
	$d_{cut,max}$ [mm]	20,55	22,55	30,55	37,70			
Depth of drill hole ^{a)}	$h_1 \geq$ [mm]	107	133	203	266			
Anchorage depth	h_{ef} [mm]	100	125	190	250			
Sleeve recess	$h_{s,min}$ [mm]	2	2	2	2			
	$h_{s,max}$ [mm]	6	7	8	8			
Torque moment	T_{inst} [Nm]	50	80	120	300			
For HDA-P/-PF/-PR								
Clearance hole	d_f [mm]	12	14	18	22			
Minimum base material thickness	h_{min} [mm]	180	200	270	350			
Fixture thickness	$t_{fix,min}$ [mm]	0	0	0	0			
	$t_{fix,max}$ [mm]	20	30	50	40	60	50	100
For HDA-T/-TF/-TR								
Clearance hole	d_f [mm]	21	23	32	40			
Minimum base material thickness	h_{min} [mm]	200- t_{fix}	230- t_{fix}	250- t_{fix}	310- t_{fix}	330- t_{fix}	400- t_{fix}	450- t_{fix}
Min. fixture thickness								
-Tension load only!	$t_{fix,min}$ [mm]	10	10	15	20	50		
-Shear load - without use of centering washer	$t_{fix,min}$ [mm]	15	15	20	25	50		
-Shear load - with use of centering washer	$t_{fix,min}$ ^{b)} [mm]	10	10	15	20	-		
Max. fixture thickness	$t_{fix,max}$ [mm]	20	30	50	40	60	50	100

a) use specified stop drill bit

b) with use of centering washer a reduction of $t_{fix,min}$ is possible for shear loading, details see ETA-99/0009

Setting parameters

Anchor size	HDA-P / HDA-PR / HDA-PF / HDA-T / HDA-TR / HDA-TF					
	M10 x100/20	M12 x125/30 x125/50		M16 x190/40 x190/60		M20 x250/50 x250/100
Minimum spacing s_{min} [mm]	100	125		190		250
Minimum edge distance c_{min} [mm]	80	100		150		200
Critical spacing for splitting failure $s_{cr,sp}$ [mm]	300	375		570		750
Critical edge distance for splitting failure $c_{cr,sp}$ [mm]	150	190		285		375
Critical spacing for concrete cone failure $s_{cr,N}$ [mm]	300	375		570		750
Critical edge distance for concrete cone failure $c_{cr,N}$ [mm]	150	190		285		375

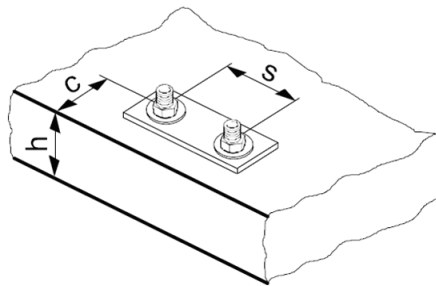

For spacing (edge distance) smaller than critical spacing (critical edge distance) the design loads have to be reduced.

Critical spacing and critical edge distance for splitting failure apply only for non-cracked concrete. For cracked concrete only the critical spacing and critical edge distance for concrete cone failure are decisive.

Simplified design method

Simplified version of the design method according ETAG 001, Annex C. Design resistance according data given in ETA-99/0009, issue 2013-03-25.

- Influence of concrete strength
- Influence of edge distance
- Influence of spacing
- Valid for a group of two anchors. (The method may also be applied for anchor groups with more than two anchors or more than one edge. The influencing factors must then be considered for each edge distance and spacing. The calculated design loads are then on the same side: They will be lower than the exact values according ETAG 001, Annex C. To avoid this, it is recommended to use the anchor design software PROFIS anchor)

The design method is based on the following simplification:

- No different loads are acting on individual anchors (no eccentricity)

The values are valid for one anchor.

For more complex fastening applications please use the anchor design software PROFIS Anchor.

Tension loading

The design tensile resistance is the lower value of

- Steel resistance: $N_{Rd,s}$
- Concrete pull-out resistance: $N_{Rd,p} = N_{Rd,p}^0 \cdot f_B$
- Concrete cone resistance: $N_{Rd,c} = N_{Rd,c}^0 \cdot f_B \cdot f_{1,N} \cdot f_{2,N} \cdot f_{3,N} \cdot f_{re,N}$
- Concrete splitting resistance (only non-cracked concrete):
 $N_{Rd,sp} = N_{Rd,c}^0 \cdot f_B \cdot f_{1,sp} \cdot f_{2,sp} \cdot f_{3,sp} \cdot f_{h,sp} \cdot f_{re,N}$

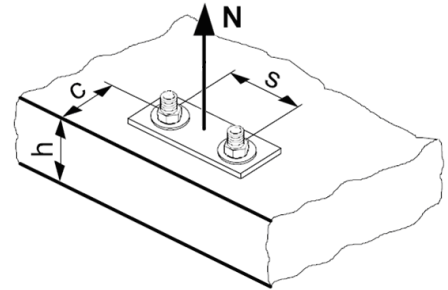

Basic design tensile resistance

Design steel resistance $N_{Rd,s}$

Anchor size		M10	M12	M16	M20 ^{a)}
$N_{Rd,s}$	HDA-P(F), HDA-T(F) [kN]	30,7	44,7	84,0	128,0
	HDA-PR, HDA-TR [kN]	28,8	41,9	78,8	-

a) HDA M20: only a galvanized 5µm version is available

Design pull-out resistance^{a)} $N_{Rd,p} = N_{Rd,p}^0 \cdot f_B$ (only in cracked concrete)

Anchor size	Non-cracked concrete				Cracked concrete			
	M10	M12	M16	M20 ^{b)}	M10	M12	M16	M20 ^{b)}
$N_{Rd,p}^0$ [kN]	-	-	-	-	16,7	23,3	50,0	63,3

a) Design pull-out resistance is not decisive in non-cracked concrete

b) HDA M20: only a galvanized 5µm version is available

Design concrete cone resistance $N_{Rd,c} = N_{Rd,c}^0 \cdot f_B \cdot f_{1,N} \cdot f_{2,N} \cdot f_{3,N} \cdot f_{re,N}$

Design splitting resistance^{a)} $N_{Rd,sp} = N_{Rd,c}^0 \cdot f_B \cdot f_{1,sp} \cdot f_{2,sp} \cdot f_{3,sp} \cdot f_{h,sp} \cdot f_{re,N}$

Anchor size	Non-cracked concrete				Cracked concrete			
	M10	M12	M16	M20 ^{b)}	M10	M12	M16	M20 ^{b)}
$N_{Rd,c}^0$ [kN]	38,7	54,1	101,4	153,1	27,7	38,7	72,5	109,3

a) Splitting resistance must only be considered for non-cracked concrete

b) HDA M20: only a galvanized 5µm version is available

Influencing factors

Influence of concrete strength

Concrete strength designation (ENV 206)	C 20/25	C 25/30	C 30/37	C 35/45	C 40/50	C 45/55	C 50/60
$f_B = (f_{ck,cube}/25N/mm^2)^{1/2}$ ^{a)}	1	1,1	1,22	1,34	1,41	1,48	1,55

a) $f_{ck,cube}$ = concrete compressive strength, measured on cubes with 150 mm side length

Influence of edge distance ^{a)}

$c/c_{cr,N}$	0,1	0,2	0,3	0,4	0,5	0,6	0,7	0,8	0,9	1
$c/c_{cr,sp}$										
$f_{1,N} = 0,7 + 0,3 \cdot c/c_{cr,N} \leq 1$	0,73	0,76	0,79	0,82	0,85	0,88	0,91	0,94	0,97	1
$f_{1,sp} = 0,7 + 0,3 \cdot c/c_{cr,sp} \leq 1$										
$f_{2,N} = 0,5 \cdot (1 + c/c_{cr,N}) \leq 1$	0,55	0,60	0,65	0,70	0,75	0,80	0,85	0,90	0,95	1
$f_{2,sp} = 0,5 \cdot (1 + c/c_{cr,sp}) \leq 1$										

a) The edge distance shall not be smaller than the minimum edge distance c_{min} given in the table with the setting details. These influencing factors must be considered for every edge distance.

Influence of anchor spacing ^{a)}

$s/s_{cr,N}$	0,1	0,2	0,3	0,4	0,5	0,6	0,7	0,8	0,9	1
$s/s_{cr,sp}$										
$f_{3,N} = 0,5 \cdot (1 + s/s_{cr,N}) \leq 1$	0,55	0,60	0,65	0,70	0,75	0,80	0,85	0,90	0,95	1
$f_{3,sp} = 0,5 \cdot (1 + s/s_{cr,sp}) \leq 1$										

a) The anchor spacing shall not be smaller than the minimum anchor spacing s_{min} given in the table with the setting details. This influencing factor must be considered for every anchor spacing.

Influence of base material thickness

h/h_{ef}	2	2,2	2,4	2,6	2,8	3	3,2	3,4	3,6	$\geq 3,68$
$f_{h,sp} = [h/(2 \cdot h_{ef})]^{2/3}$	1	1,07	1,13	1,19	1,25	1,31	1,37	1,42	1,48	1,5

Influence of reinforcement

Anchor size	M10	M12	M16	M20
$f_{re,N} = 0,5 + h_{ef}/200\text{mm} \leq 1$	1			

Shear loading

The design shear resistance is the lower value of

- Steel resistance: $V_{Rd,s}$
- Concrete pryout resistance: $V_{Rd,cp} = k \cdot N_{Rd,c}$
- Concrete edge resistance: $V_{Rd,c} = V_{Rd,c}^0 \cdot f_B \cdot f_{\beta} \cdot f_h \cdot f_4 \cdot f_{hef} \cdot f_c$

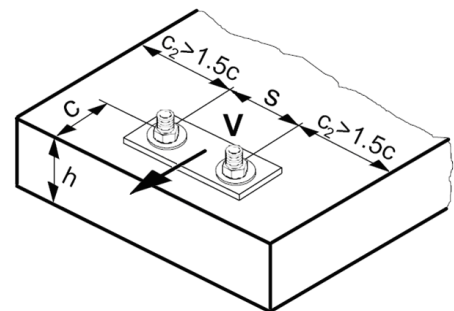

Basic design shear resistance

Design steel resistance $V_{Rd,s}$

Anchor size		M10	M12	M16	M20 ^{a)}
$V_{Rd,s}$	HDA-P, HDA-PF [kN]	17,6	24,0	49,6	73,6
	HDA-PR [kN]	17,3	25,6	47,4	-
	HDA-T, HDA-TF ^{b)} [kN]	43,3	53,3	93,3	136,7
	HDA-TR ^{b)} [kN]	53,4	65,4	114,3	-

- a) HDA M20: only a galvanized 5µm version is available
- b) Values are valid for minimum thickness of the base plate $t_{fix,min}$. For characteristic resistance to shear loads with thicker base plates see ETA-99/0009 or use PROFIS software.

Design concrete pryout resistance $V_{Rd,cp} = k \cdot N_{Rd,c}$ ^{a)}

Anchor size	M10	M12	M16	M20
k	2,0			

- a) $N_{Rd,c}$: Design concrete cone resistance

Design concrete edge resistance^{a)} $V_{Rd,c} = V_{Rd,c}^0 \cdot f_B \cdot f_{\beta} \cdot f_h \cdot f_4 \cdot f_{hef} \cdot f_c$

Anchor size	Non-cracked concrete				Cracked concrete			
	M10	M12	M16	M20 ^{b)}	M10	M12	M16	M20 ^{b)}
$V_{Rd,c}^0$ [kN]	25,1	29,8	51,1	70,0	17,8	21,1	36,2	49,6

- a) For anchor groups with more than two anchors only the anchors close to the edge must be considered.
- b) HDA M20: only a galvanized 5µm version is available

Influencing factors

Influence of concrete strength

Concrete strength designation (ENV 206)	C 20/25	C 25/30	C 30/37	C 35/45	C 40/50	C 45/55	C 50/60
$f_B = (f_{ck,cube}/25N/mm^2)^{1/2}$ ^{a)}	1	1,1	1,22	1,34	1,41	1,48	1,55

- a) $f_{ck,cube}$ = concrete compressive strength, measured on cubes with 150 mm side length

Influence of angle between load applied and the direction perpendicular to the free edge

Angle β	0°	10°	20°	30°	40°	50°	60°	70°	80°	≥ 90°
$f_{\beta} = \frac{1}{\sqrt{(\cos \alpha_V)^2 + \left(\frac{\sin \alpha_V}{2,5}\right)^2}}$	1	1,01	1,05	1,13	1,24	1,40	1,64	1,97	2,32	2,50

Influence of base material thickness

h/c	0,15	0,3	0,45	0,6	0,75	0,9	1,05	1,2	1,35	≥ 1,5
$f_h = \{h/(1,5 \cdot c)\}^{1/2} \leq 1$	0,32	0,45	0,55	0,63	0,71	0,77	0,84	0,89	0,95	1,00

Influence of anchor spacing and edge distance ^{a)} for concrete edge resistance: f_4
 $f_4 = (c/h_{ef})^{1,5} \cdot (1 + s / [3 \cdot c]) \cdot 0,5$

c/h _{ef}	Single anchor	Group of two anchors s/h _{ef}														
		0,75	1,50	2,25	3,00	3,75	4,50	5,25	6,00	6,75	7,50	8,25	9,00	9,75	10,50	11,25
0,50	0,35	0,27	0,35	0,35	0,35	0,35	0,35	0,35	0,35	0,35	0,35	0,35	0,35	0,35	0,35	0,35
0,75	0,65	0,43	0,54	0,65	0,65	0,65	0,65	0,65	0,65	0,65	0,65	0,65	0,65	0,65	0,65	0,65
1,00	1,00	0,63	0,75	0,88	1,00	1,00	1,00	1,00	1,00	1,00	1,00	1,00	1,00	1,00	1,00	1,00
1,25	1,40	0,84	0,98	1,12	1,26	1,40	1,40	1,40	1,40	1,40	1,40	1,40	1,40	1,40	1,40	1,40
1,50	1,84	1,07	1,22	1,38	1,53	1,68	1,84	1,84	1,84	1,84	1,84	1,84	1,84	1,84	1,84	1,84
1,75	2,32	1,32	1,49	1,65	1,82	1,98	2,15	2,32	2,32	2,32	2,32	2,32	2,32	2,32	2,32	2,32
2,00	2,83	1,59	1,77	1,94	2,12	2,30	2,47	2,65	2,83	2,83	2,83	2,83	2,83	2,83	2,83	2,83
2,25	3,38	1,88	2,06	2,25	2,44	2,63	2,81	3,00	3,19	3,38	3,38	3,38	3,38	3,38	3,38	3,38
2,50	3,95	2,17	2,37	2,57	2,77	2,96	3,16	3,36	3,56	3,76	3,95	3,95	3,95	3,95	3,95	3,95
2,75	4,56	2,49	2,69	2,90	3,11	3,32	3,52	3,73	3,94	4,15	4,35	4,56	4,56	4,56	4,56	4,56
3,00	5,20	2,81	3,03	3,25	3,46	3,68	3,90	4,11	4,33	4,55	4,76	4,98	5,20	5,20	5,20	5,20
3,25	5,86	3,15	3,38	3,61	3,83	4,06	4,28	4,51	4,73	4,96	5,18	5,41	5,63	5,86	5,86	5,86
3,50	6,55	3,51	3,74	3,98	4,21	4,44	4,68	4,91	5,14	5,38	5,61	5,85	6,08	6,31	6,55	6,55
3,75	7,26	3,87	4,12	4,36	4,60	4,84	5,08	5,33	5,57	5,81	6,05	6,29	6,54	6,78	7,02	7,26
4,00	8,00	4,25	4,50	4,75	5,00	5,25	5,50	5,75	6,00	6,25	6,50	6,75	7,00	7,25	7,50	7,75
4,25	8,76	4,64	4,90	5,15	5,41	5,67	5,93	6,18	6,44	6,70	6,96	7,22	7,47	7,73	7,99	8,25
4,50	9,55	5,04	5,30	5,57	5,83	6,10	6,36	6,63	6,89	7,16	7,42	7,69	7,95	8,22	8,49	8,75
4,75	10,35	5,45	5,72	5,99	6,27	6,54	6,81	7,08	7,36	7,63	7,90	8,17	8,45	8,72	8,99	9,26
5,00	11,18	5,87	6,15	6,43	6,71	6,99	7,27	7,55	7,83	8,11	8,39	8,66	8,94	9,22	9,50	9,78
5,25	12,03	6,30	6,59	6,87	7,16	7,45	7,73	8,02	8,31	8,59	8,88	9,17	9,45	9,74	10,02	10,31
5,50	12,90	6,74	7,04	7,33	7,62	7,92	8,21	8,50	8,79	9,09	9,38	9,67	9,97	10,26	10,55	10,85

a) The anchor spacing and the edge distance shall not be smaller than the minimum anchor spacing s_{min} and the minimum edge distance c_{min} .

Influence of embedment depth

Anchor size	M10	M12	M16	M20
$f_{hef} = 0,05 \cdot (h_{ef} / d)^{1,68}$	0,81	1,00	1,18	1,36

Influence of edge distance ^{a)}

c/d	4	6	8	10	15	20	30	40
$f_c = (d / c)^{0,19}$	0,77	0,71	0,67	0,65	0,60	0,57	0,52	0,50

a) The edge distance shall not be smaller than the minimum edge distance c_{min} .

Combined tension and shear loading

For combined tension and shear loading see section "Anchor Design".

Precalculated values

Design resistance calculated according ETAG 001, Annex C and data given in ETA-99/0009, issue 2013-03-25. All data applies to concrete C 20/25 – $f_{ck,cube} = 25 \text{ N/mm}^2$. HDA-PF and HDA-TF anchors are not covered by the approval. For HDA-T and HDA-TR anchors the resistance to shear loads is calculated for the minimum thickness of the base plate given in chapter setting details.

Recommended loads can be calculated by dividing the design resistance by an overall partial safety factor for action $\gamma = 1,4$. The partial safety factors for action depend on the type of loading and shall be taken from national regulations.

Design resistance

Single anchor, no edge effects, shear without lever arm

Anchor size		Non-cracked concrete				Cracked concrete			
		M10	M12	M16	M20	M10	M12	M16	M20
Min. base material thickness h_{min} [mm]		180	200	270	350	180	200	270	350
HDA-T: Min. fixture thickness t_{fix} [mm]		15	15	20	25	15	15	20	25
	Tensile N_{Rd}								
	HDA-P(F), HDA-T(F) [kN]	30,7	44,7	84,0	128,0	16,7	23,3	50,0	63,3
	HDA-PR, HDA-TR [kN]	28,8	41,9	78,8	-	16,7	23,3	50,0	-
	Shear V_{Rd}								
	HDA-P, HDA-PF [kN]	17,6	24,0	49,6	73,6	17,6	24,0	49,6	73,6
	HDA-PR [kN]	17,3	25,6	47,4	-	17,3	25,6	47,4	-
	HDA-T, HDA-TF [kN]	43,3	53,3	93,3	136,7	43,3	53,3	93,3	136,7
	HDA-TR [kN]	53,4	65,4	114,3	-	53,4	65,4	114,3	-



Single anchor, min. edge distance ($c = c_{min}$), shear without lever arm

Anchor size		Non-cracked concrete				Cracked concrete			
		M10	M12	M16	M20	M10	M12	M16	M20
Min. base material thickness h_{min} [mm]		180	200	270	350	180	200	270	350
HDA-T: Min. fixture thickness t_{fix} [mm]		15	15	20	25	15	15	20	25
Min. edge distance c_{min} [mm]		80	100	150	200	80	100	150	200
	Tensile N_{Rd}								
	HDA-P(F), HDA-T(F) HDA-PR, HDA-TR [kN]	25,5	35,9	66,4	100,9	16,7	23,3	47,4	63,3
	Shear V_{Rd}								
	HDA-P, HDA-PF								
	HDA-PR								
	HDA-T, HDA-TF [kN]	10,4	14,8	26,4	41,8	7,3	10,5	18,7	29,6
	HDA-TR								

Double anchor, no edge effects, min. spacing ($s = s_{min}$), shear without lever arm (load values are valid for one anchor)

Anchor size		Non-cracked concrete				Cracked concrete			
		M10	M12	M16	M20	M10	M12	M16	M20
Min. base material thickness h_{min} [mm]		180	200	270	350	180	200	270	350
HDA-T: Min. fixture thickness t_{fix} [mm]		15	15	20	25	15	15	20	25
Min. spacing s_{min} [mm]		100	125	190	250	100	125	190	250
	Tensile N_{Rd}								
	HDA-P(F), HDA-T(F) HDA-PR, HDA-TR [kN]	25,8	36,0	67,6	102,1	16,7	23,3	48,3	63,3
	Shear V_{Rd}								
	HDA-P, HDA-PF [kN]	17,6	24,0	49,6	73,6	17,6	24,0	49,6	73,6
	HDA-PR [kN]	17,3	25,6	47,4	-	17,3	25,6	47,4	-
	HDA-T, HDA-TF [kN]	43,3	53,3	93,3	136,7	36,9	51,4	93,3	136,7
	HDA-TR [kN]	51,6	65,4	114,3	-	36,9	51,4	96,6	-

HMU-PF Undercut anchor

Anchor version		Benefits
	M12 HMU-PF	<ul style="list-style-type: none"> - reliable mechanical interlock due to consistent high quality undercut - comes standard with a hot-dip galvanized protective coating against corrosion - cost efficient heavy duty anchoring solution for high volume fastenings - easy verification of correct setting due to red setting mark - optimized and matching system components enable efficient and reliable installation
	M16 HMU-PF	



Concrete



Tensile zone



Seismic
ETA-C1

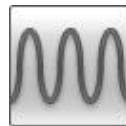

Fatigue



Shock

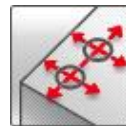

Small edge
distance
and spacing



Fire
resistance



European
Technical
Approval



CE
conformity



PROFIS
Anchor design
software

Approvals / certificates

Description	Authority / Laboratory	No. / date of issue
European Technical Assessment	CSTB, Paris	ETA-14/0069 / 2014-04-02
Shockproof fastenings in civil defence installations	Federal Office for Civil Protection, Bern	BZS D 14-602/ 2014-10-31

a) All data given in this section for HMU-PF M12 and M16 according to ETA-14/0001, issue 2014-04-02.

Basic loading data (for a single anchor)

All data in this section is applies to

- Correct setting (See setting instruction)
- No edge distance and spacing influence
- Concrete as specified in the table
- Steel failure
- Minimum base material thickness
- Concrete C 20/25, $f_{ck,cube} = 25 \text{ N/mm}^2$

For details see Simplified design method

Mean ultimate resistance

		Non-cracked concrete			Cracked concrete		
Anchor size	HMU-PF	M12x80	M16x100	M16x125	M12x80	M16x100	M16x125
Effective anchorage depth $h_{ef} \geq$	[mm]	80	100	125	80	100	125
Tensile $N_{Ru,m}$	[kN]	48,0	67,0	93,7	26,6	47,8	53,1
Shear $V_{Ru,m}$	[kN]	35,4	65,9	65,9	35,4	65,9	65,9

Characteristic resistance

		Non-cracked concrete			Cracked concrete		
Anchor size	HMU-PF	M12x80	M16x100	M16x125	M12x80	M16x100	M16x125
Effective anchorage depth $h_{ef} \geq$	[mm]	80	100	125	80	100	125
Tensile N_{Rk}	[kN]	36,1	50,5	70,6	20,0	36,0	40,0
Shear V_{Rk}	[kN]	33,7	62,8	62,8	33,7	62,8	62,8

Design resistance

		Non-cracked concrete			Cracked concrete		
Anchor size	HMU-PF	M12x80	M16x100	M16x125	M12x80	M16x100	M16x125
Effective anchorage depth $h_{ef} \geq$	[mm]	80	100	125	80	100	125
Tensile N_{Rd}	[kN]	24,1	33,7	47,1	13,3	24,0	26,7
Shear V_{Rd}	[kN]	27,0	50,2	50,2	27,0	48,0	50,2

Recommended loads

		Non-cracked concrete			Cracked concrete		
Anchor size	HMU-PF	M12x80	M16x100	M16x125	M12x80	M16x100	M16x125
Effective anchorage depth $h_{ef} \geq$	[mm]	80	100	125	80	100	125
Tensile $N_{rec}^{a)}$	[kN]	17,2	24,0	33,6	9,5	17,1	19,0
Shear $V_{rec}^{a)}$	[kN]	19,3	35,9	35,9	19,3	34,3	35,9

a) With overall partial safety factor for action $\gamma = 1,4$. The partial safety factors for action depend on the type of loading and shall be taken from national regulations.

Materials

Mechanical properties of the anchor bolt

Anchor size		HMU-PF M12x80	HMU-PF M16x100	HMU-PF M16x125
Nominal tensile strength	f_{uk} [N/mm ²]	800		
Yield strength	f_{yk} [N/mm ²]	640		
Stressed cross-section, thread	A_s [mm ²]	84,3	157	
Moment of resistance	W [mm ³]	109	278	
Char. bending resistance	$M^0_{Rk,s}$ [Nm]	105	266	

Material quality

Part	Material
Bolt	Carbon steel strength 8.8, hot dip galvanized to min. 50 µm
Expansion sleeve	Carbon steel, hot dip galvanized min. 50µm
Hexagon nut	Steel grade 8, hot dip galvanized min. 50µm
Washer	According to DIN 125-1, 140 HV, hot dip galvanized min. 50µm

Letter code for anchor length

Anchor size	HMU-PF M12	M12x80/20	M12x80/35	M12x80/65
Letter code		Ⓜ	Ⓝ	Ⓞ
Anchor size	HMU-PF M16	M16x100/30	M16x100/60	M16x125/60
Letter code		Ⓚ	Ⓜ	Ⓞ

Anchor dimensions

Anchor size	HMU-PF	HMU-PF M12x80	HMU-PF M16x100	HMU-PF M16x125
Total length of bolt L_B	Min [mm]	133	167	222
	max [mm]	176	197	-
Diameter of sleeve d_s	[mm]	17,5	21,6	
Length of sleeve l_s	[mm]	80,6	102	127

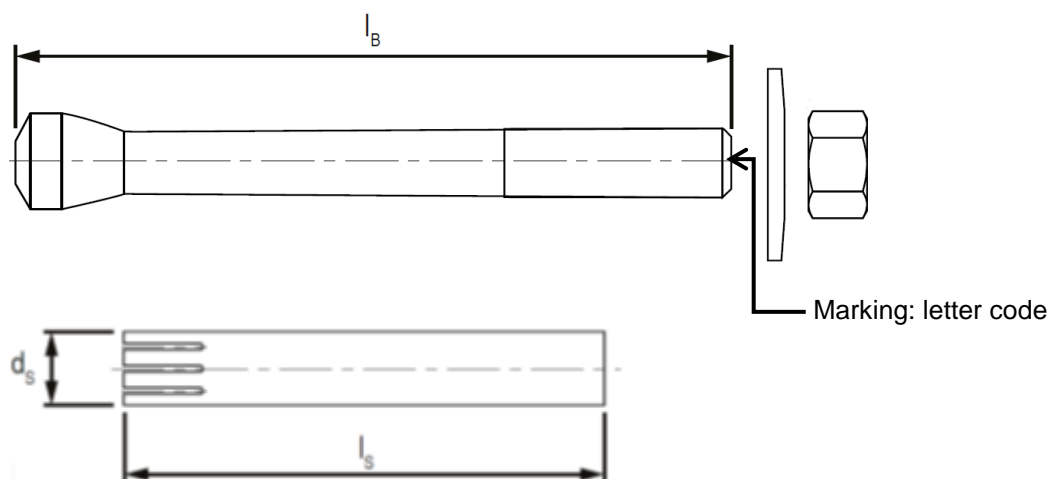

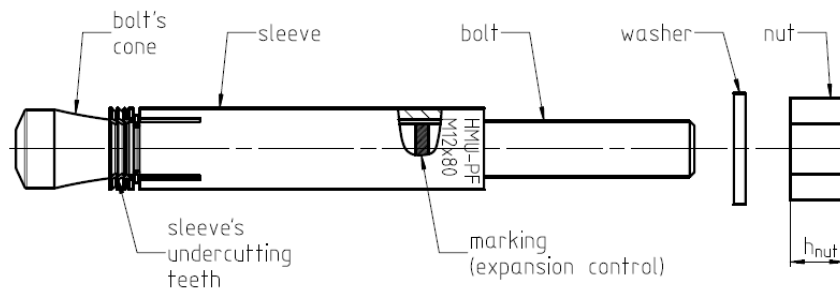

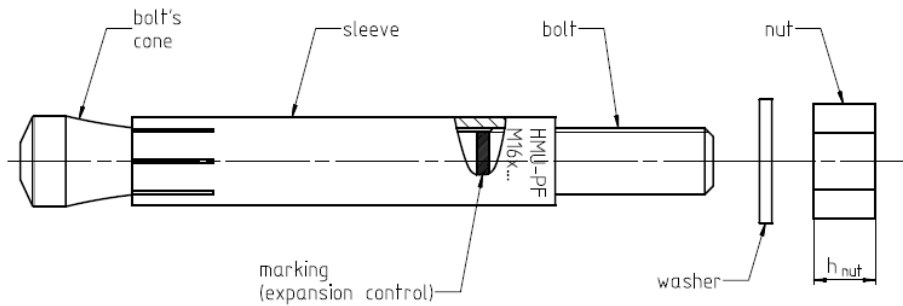

HMU-PF M12



HMU-PF M16

Setting

Installation equipment

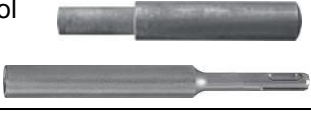
Anchor size	HMU-PF M12x80	HMU-PF M16x100	HMU-PF M16x125
Rotary hammer For undercutting 	TE 30 TE 30-A36 TE 40	TE 40	
Stop drill bit 	TE-C-HMU B 18x80- M12	TE-C-HMU B 22x100- M16	TE-C-HMU B 22x125- M16
Undercutting tool 	Not needed	TE-C HMU-UT 22-M16	
Setting tool 	HMU-ST M12 + recommended TE tool (see IFU)	HMU-ST M16 + hammer	
Other tools	Blow-out bulb		

Setting instructions for M12 (left hand side) and M16 (right hand side) HMU undercut anchor

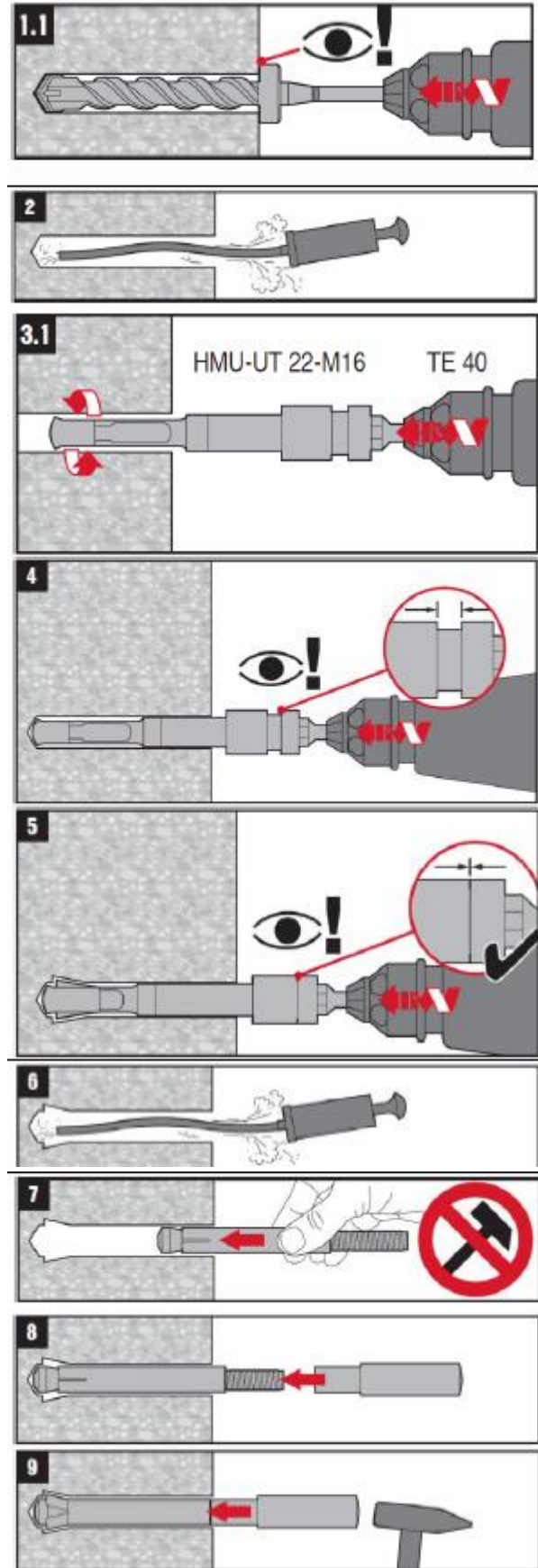
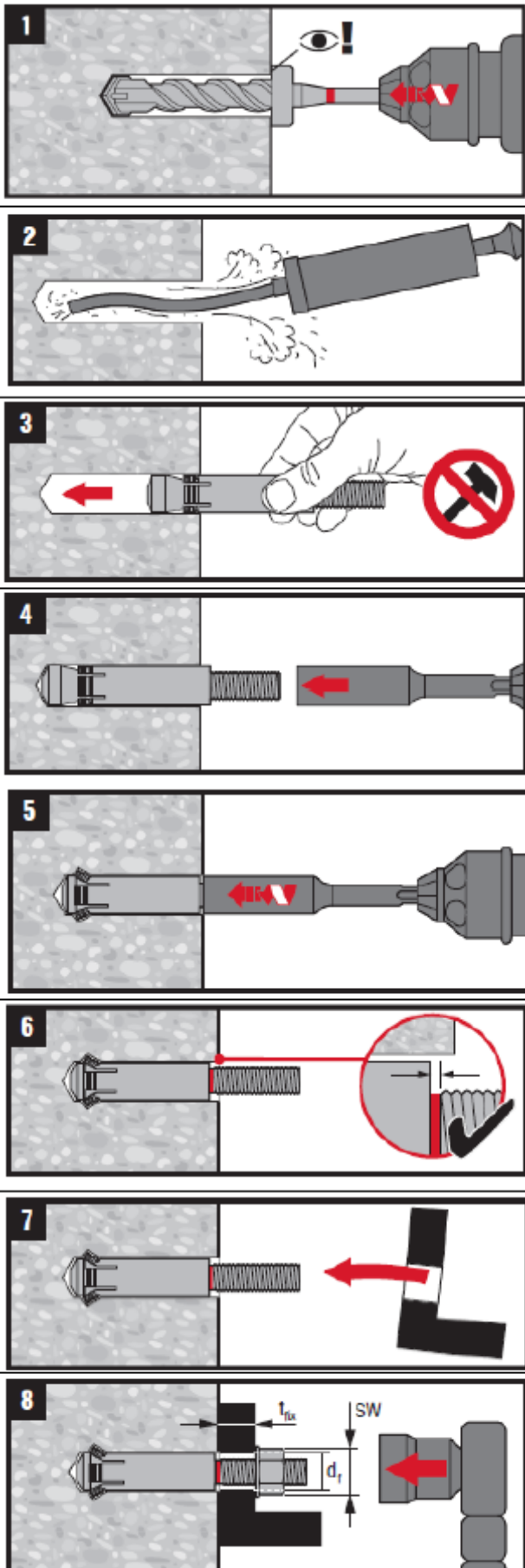

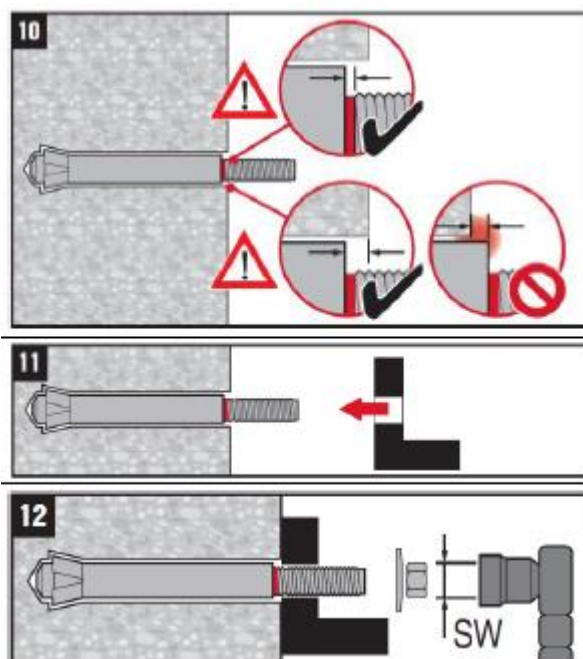

For detailed information on installation see instruction for use given with the package of the product.

Setting details

Anchor size	HMU-PF M12x80	HMU-PF M16x100	HMU-PF M16x125
Effective anchorage depth h_{ef} [mm]	80	100	125
Nominal Diameter of drill bit d_0 [mm]	18	22	
Cutting diameter of drill bit ^{a)} $d_{cut} \leq$ [mm]	18,5	22,8	
Depth of drill hole ^{a)} $h_1 =$ [mm]	92	108	132
Diameter of clearance hole in the fixture $d_f \leq$ [mm]	14	18	
Thickness of fixture t_{fix} [mm]	2 ... 65	5 ... 60	5 ... 60
Torque moment T_{inst} [Nm]	45	120	
Width across nut flats SW [mm]	19	24	

a) use special stop drill bit TE-C-HMU-B only

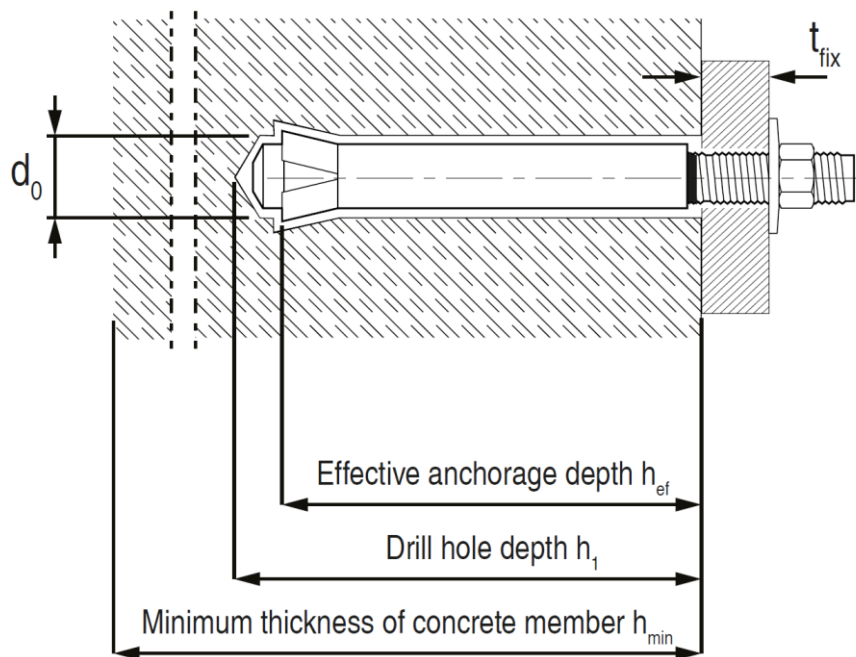

Setting parameters ^{a)}

Anchor size		HMU-PF M12x80	HMU-PF M16x100	HMU-PF M16x125
Effective anchorage depth	h_{ef} [mm]	80	100	125
Minimum base material thickness	$h_{min} \geq$ [mm]	160	200	250
Minimum spacing	$s_{min} \geq$ [mm]	90	100	100
Minimum edge distance	$c_{min} \geq$ [mm]	90	100	100
Critical spacing for splitting failure	$s_{cr,sp}$ [mm]	300	300	375
Critical edge distance for splitting failure	$c_{cr,sp}$ [mm]	150	150	188
Critical spacing for concrete cone failure	$s_{cr,N}$ [mm]	240	300	375
Critical edge distance for concrete cone failure	$c_{cr,N}$ [mm]	120	150	188

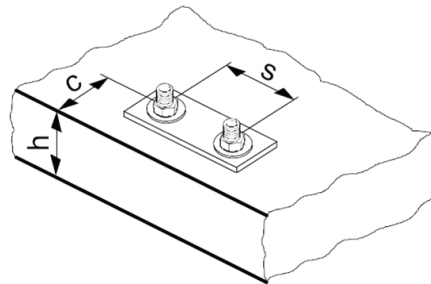

b) In case of smaller edge distance and spacing than $c_{cr,sp}$, $s_{cr,sp}$, $c_{cr,N}$ and $s_{cr,N}$ the load values shall be reduced according ETAG 001, Annex C

Critical spacing and critical edge distance for splitting failure apply only for non-cracked concrete. For cracked concrete only the critical spacing and critical edge distance for concrete cone failure are decisive.

Simplified design method

Simplified version of the design method according ETAG 001, Annex C. Design resistance according data given in ETA-14/0069, issue 2014-04-02.

- Influence of concrete strength
- Influence of edge distance
- Influence of spacing
- Valid for a group of two anchors. The method may also be applied for anchor groups with more than two anchors or more than one edge. The influencing factors must then be considered for each edge distance and spacing. The calculated design loads are then on the same side: They will be lower than the exact values according ETAG 001, Annex C.

The design method is based on the following simplification:

- No different loads are acting on individual anchors (no eccentricity)

The values are valid for one anchor.

For more complex fastening applications please use the anchor design software PROFIS Anchor.

Tension loading

The design tensile resistance is the lower value of

- Steel resistance: $N_{Rd,s}$
- Concrete pull-out resistance: $N_{Rd,p} = N_{Rd,p}^0 \cdot f_B$
- Concrete cone resistance: $N_{Rd,c} = N_{Rd,c}^0 \cdot f_B \cdot f_{1,N} \cdot f_{2,N} \cdot f_{3,N} \cdot f_{re,N}$
- Concrete splitting resistance (only non-cracked concrete):
 $N_{Rd,sp} = N_{Rd,c}^0 \cdot f_B \cdot f_{1,sp} \cdot f_{2,sp} \cdot f_{3,sp} \cdot f_{h,sp} \cdot f_{re,N}$

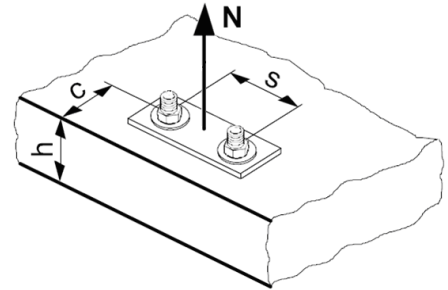

Basic design tensile resistance

Design steel resistance $N_{Rd,s}$

Anchor size	HMU-PF	M12x80	M16x100	M16x125
$N_{Rd,s}$	[kN]	44,9	83,7	

Design pull-out resistance $N_{Rd,p} = N_{Rd,p}^0 \cdot f_B$

		Non-cracked concrete			Cracked concrete		
Anchor size	HMU-PF	M12x80	M16x100	M16x125	M12x80	M16x100	M16x125
Effective anchorage depth $h_{ef} \geq$	[mm]	80	100	125	80	100	125
$N_{Rd,p}^0$	[kN]	N.A.			13,3	N.A.	26,7

Design concrete cone resistance $N_{Rd,c} = N_{Rd,c}^0 \cdot f_B \cdot f_{1,N} \cdot f_{2,N} \cdot f_{3,N} \cdot f_{re,N}$

Design splitting resistance ^{a)} $N_{Rd,sp} = N_{Rd,c}^0 \cdot f_B \cdot f_{1,sp} \cdot f_{2,sp} \cdot f_{3,sp} \cdot f_{h,sp} \cdot f_{re,N}$

		Non-cracked concrete			Cracked concrete		
Anchor size	HMU-PF	M12x80	M16x100	M16x125	M12x80	M16x100	M16x125
Effective anchorage depth $h_{ef} \geq$	[mm]	80	100	125	80	100	125
$N_{Rd,c}^0$	[kN]	24,1	33,7	47,1	17,2	24,0	33,5

Influencing factors

Influence of concrete strength on pull-out, concrete cone and splitting resistance

Concrete strength designation (ENV 206)	C 20/25	C 25/30	C 30/37	C 35/45	C 40/50	C 45/55	C 50/60
$f_B = (f_{ck,cube}/25N/mm^2)^{1/2 a)}$	1	1,1	1,22	1,34	1,41	1,48	1,55

a) $f_{ck,cube}$ = concrete compressive strength, measured on cubes with 150 mm side length

Influence of edge distance ^{a)}

$c/c_{cr,N}$	0,1	0,2	0,3	0,4	0,5	0,6	0,7	0,8	0,9	1
$c/c_{cr,sp}$										
$f_{1,N} = 0,7 + 0,3 \cdot c/c_{cr,N} \leq 1$	0,73	0,76	0,79	0,82	0,85	0,88	0,91	0,94	0,97	1
$f_{1,sp} = 0,7 + 0,3 \cdot c/c_{cr,sp} \leq 1$										
$f_{2,N} = 0,5 \cdot (1 + c/c_{cr,N}) \leq 1$	0,55	0,60	0,65	0,70	0,75	0,80	0,85	0,90	0,95	1
$f_{2,sp} = 0,5 \cdot (1 + c/c_{cr,sp}) \leq 1$										

a) The edge distance shall not be smaller than the minimum edge distance c_{min} given in the table with the setting details. These influencing factors must be considered for every edge distance.

Influence of anchor spacing ^{a)}

$s/s_{cr,N}$	0,1	0,2	0,3	0,4	0,5	0,6	0,7	0,8	0,9	1
$s/s_{cr,sp}$										
$f_{3,N} = 0,5 \cdot (1 + s/s_{cr,N}) \leq 1$	0,55	0,60	0,65	0,70	0,75	0,80	0,85	0,90	0,95	1
$f_{3,sp} = 0,5 \cdot (1 + s/s_{cr,sp}) \leq 1$										

a) The anchor spacing shall not be smaller than the minimum anchor spacing s_{min} given in the table with the setting details. This influencing factor must be considered for every anchor spacing.

Influence of base material thickness

h/h_{ef}	2,0	2,2	2,4	2,6	2,8	3,0	3,2	3,4	3,6	$\geq 3,68$
$f_{h,sp} = [h/(2 \cdot h_{ef})]^{2/3}$	1	1,07	1,13	1,19	1,25	1,31	1,37	1,42	1,48	1,5

Influence of reinforcement

Anchor size	M12x80	M16x100	M16x125
$f_{re,N} = 0,5 + h_{ef}/200\text{mm} \leq 1$	0,9	1	1

Shear loading

The design shear resistance is the lower value of

- Steel resistance: $V_{Rd,s}$
- Concrete pryout resistance: $V_{Rd,cp} = k \cdot N_{Rd,c}$
- Concrete edge resistance: $V_{Rd,c} = V_{Rd,c}^0 \cdot f_B \cdot f_{lB} \cdot f_h \cdot f_4 \cdot f_c$

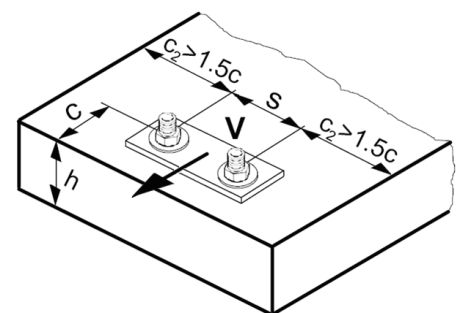

Basic design shear resistance

Design steel resistance $V_{Rd,s}$

Anchor size	HMU-PF M12x80	HMU-PF M16x100	HMU-PF M16x125
$V_{Rd,s}$ [kN]	27,0	50,2	

Design concrete pryout resistance $V_{Rd,cp} = k \cdot N_{Rd,c}$ ^{a)}

Anchor size	HMU-PF M12x80	HMU-PF M16x100	HMU-PF M16x125
k	2		

a) $N_{Rd,c}$: Design concrete cone resistance

Design concrete edge resistance $V_{Rd,c}^a = V_{Rd,c}^0 \cdot f_B \cdot f_\beta \cdot f_h \cdot f_c$

Anchor size	HMU-PF	Non-cracked concrete			Cracked concrete		
		M12x80	M16x100	M16x125	M12x80	M16x100	M16x125
Effective anchorage depth $h_{ef} \geq$	[mm]	80	100	125	80	100	125
$V_{Rd,c}^0$	[kN]	22,9	36,8	47,7	16,2	26,1	33,8

a) For anchor groups only the anchors close to the edge must be considered.

Influencing factors

Influence of concrete strength

Concrete strength designation (ENV 206)	C 20/25	C 25/30	C 30/37	C 35/45	C 40/50	C 45/55	C 50/60
$f_B = (f_{ck,cube}/25N/mm^2)^{1/2}$ ^{a)}	1	1,1	1,22	1,34	1,41	1,48	1,55

a) $f_{ck,cube}$ = concrete compressive strength, measured on cubes with 150 mm side length

Influence of angle between load applied and the direction perpendicular to the free edge

Angle β	0°	10°	20°	30°	40°	50°	60°	70°	80°	≥ 90°
$f_\beta = \sqrt{\frac{1}{(\cos \alpha_V)^2 + \left(\frac{\sin \alpha_V}{2,5}\right)^2}}$	1	1,01	1,05	1,13	1,24	1,40	1,64	1,97	2,32	2,50

Influence of base material thickness

h/c	0,15	0,3	0,45	0,6	0,75	0,9	1,05	1,2	1,35	≥ 1,5
$f_h = \{h/(1,5 \cdot c)\}^{1/2} \leq 1$	0,32	0,45	0,55	0,63	0,71	0,77	0,84	0,89	0,95	1,00

Influence of anchor spacing and edge distance ^{a)} for concrete edge resistance: f_4

$$f_4 = (c/h_{ef})^{1,5} \cdot (1 + s / [3 \cdot c]) \cdot 0,5$$

c/h _{ef}	Single anchor	Group of two anchors s/h _{ef}														
		0,75	1,50	2,25	3,00	3,75	4,50	5,25	6,00	6,75	7,50	8,25	9,00	9,75	10,50	11,25
0,50	0,35	0,27	0,35	0,35	0,35	0,35	0,35	0,35	0,35	0,35	0,35	0,35	0,35	0,35	0,35	0,35
0,75	0,65	0,43	0,54	0,65	0,65	0,65	0,65	0,65	0,65	0,65	0,65	0,65	0,65	0,65	0,65	0,65
1,00	1,00	0,63	0,75	0,88	1,00	1,00	1,00	1,00	1,00	1,00	1,00	1,00	1,00	1,00	1,00	1,00
1,25	1,40	0,84	0,98	1,12	1,26	1,40	1,40	1,40	1,40	1,40	1,40	1,40	1,40	1,40	1,40	1,40
1,50	1,84	1,07	1,22	1,38	1,53	1,68	1,84	1,84	1,84	1,84	1,84	1,84	1,84	1,84	1,84	1,84
1,75	2,32	1,32	1,49	1,65	1,82	1,98	2,15	2,32	2,32	2,32	2,32	2,32	2,32	2,32	2,32	2,32
2,00	2,83	1,59	1,77	1,94	2,12	2,30	2,47	2,65	2,83	2,83	2,83	2,83	2,83	2,83	2,83	2,83
2,25	3,38	1,88	2,06	2,25	2,44	2,63	2,81	3,00	3,19	3,38	3,38	3,38	3,38	3,38	3,38	3,38
2,50	3,95	2,17	2,37	2,57	2,77	2,96	3,16	3,36	3,56	3,76	3,95	3,95	3,95	3,95	3,95	3,95
2,75	4,56	2,49	2,69	2,90	3,11	3,32	3,52	3,73	3,94	4,15	4,35	4,56	4,56	4,56	4,56	4,56
3,00	5,20	2,81	3,03	3,25	3,46	3,68	3,90	4,11	4,33	4,55	4,76	4,98	5,20	5,20	5,20	5,20
3,25	5,86	3,15	3,38	3,61	3,83	4,06	4,28	4,51	4,73	4,96	5,18	5,41	5,63	5,86	5,86	5,86
3,50	6,55	3,51	3,74	3,98	4,21	4,44	4,68	4,91	5,14	5,38	5,61	5,85	6,08	6,31	6,55	6,55
3,75	7,26	3,87	4,12	4,36	4,60	4,84	5,08	5,33	5,57	5,81	6,05	6,29	6,54	6,78	7,02	7,26
4,00	8,00	4,25	4,50	4,75	5,00	5,25	5,50	5,75	6,00	6,25	6,50	6,75	7,00	7,25	7,50	7,75
4,25	8,76	4,64	4,90	5,15	5,41	5,67	5,93	6,18	6,44	6,70	6,96	7,22	7,47	7,73	7,99	8,25
4,50	9,55	5,04	5,30	5,57	5,83	6,10	6,36	6,63	6,89	7,16	7,42	7,69	7,95	8,22	8,49	8,75
4,75	10,35	5,45	5,72	5,99	6,27	6,54	6,81	7,08	7,36	7,63	7,90	8,17	8,45	8,72	8,99	9,26
5,00	11,18	5,87	6,15	6,43	6,71	6,99	7,27	7,55	7,83	8,11	8,39	8,66	8,94	9,22	9,50	9,78
5,25	12,03	6,30	6,59	6,87	7,16	7,45	7,73	8,02	8,31	8,59	8,88	9,17	9,45	9,74	10,02	10,31
5,50	12,90	6,74	7,04	7,33	7,62	7,92	8,21	8,50	8,79	9,09	9,38	9,67	9,97	10,26	10,55	10,85

a) The anchor spacing and the edge distance shall not be smaller than the minimum anchor spacing s_{min} and the minimum edge distance c_{min} .

Influence of edge distance ^{a)}

c/d	4	6	8	10	15	20	30	40
$f_c = (d/c)^{0,19}$	0,77	0,71	0,67	0,65	0,60	0,57	0,52	0,50

a) The edge distance shall not be smaller than the minimum edge distance c_{min} .

Combined tension and shear loading

The following equations must be satisfied

$$\beta_N \leq 1$$

$$\beta_V \leq 1$$

$$\beta_N + \beta_V \leq 1,2 \text{ or } \beta_N^\alpha + \beta_V^\alpha \leq 1$$

With

$$\beta_N = N_{Sd} / N_{Rd} \text{ and}$$

$$\beta_V = V_{Sd} / V_{Rd}$$

$$N_{Sd} (V_{Sd}) = \text{tension (shear) design action}$$

$$N_{Rd} (V_{Rd}) = \text{tension (shear) design resistance}$$

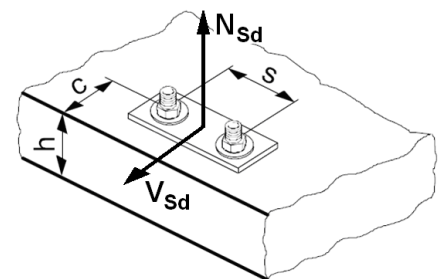

Annex C of ETAG 001

$\alpha = 2,0$ if N_{Rd} and V_{Rd} are governed by steel failure

$\alpha = 1,5$ for all other failure modes

Simplified design method

Failure mode is not considered for the simplified method

$\alpha = 1,5$ for all failure modes (leading to conservative results)

Precalculated values

Design resistance calculated according ETAG 001, Annex C and data given in ETA-14/0069, issue 2014-04-02. All data applies to concrete C 20/25 – $f_{ck,cube} = 25 \text{ N/mm}^2$.

Recommended loads can be calculated by dividing the design resistance by an overall partial safety factor for action $\gamma = 1,4$. The partial safety factors for action depend on the type of loading and shall be taken from national regulations.

Design resistance

Single anchor, no edge effects, shear without lever arm

Anchor size			Non-cracked concrete			Cracked concrete		
			M12x80	M16x100	M16x125	M12x80	M16x100	M16x125
Min. base material thickness h_{min} [mm]			160	200	250	160	200	250
	Tensile N_{Rd}	[kN]	24,1	33,7	47,1	13,3	24,0	26,7
	Shear V_{Rd}	[kN]	27,0	50,2	50,2	27,0	48,0	50,2

Single anchor, min. edge distance ($c = c_{min}$), shear without lever arm

Anchor size			Non-cracked concrete			Cracked concrete		
			M12x80	M16x100	M16x125	M12x80	M16x100	M16x125
Min. base material thickness h_{min} [mm]			160	200	250	160	200	250
Min. edge distance c_{min} [mm]			90	100	100	90	100	100
	Tensile N_{Rd}	[kN]	17,0	25,3	31,0	12,1	18,0	22,1
	Shear V_{Rd}	[kN]	12,2	15,2	16,0	8,7	10,8	11,3

Double anchor, no edge effects, min. spacing ($s = s_{min}$), shear without lever arm (load values are valid for one anchor)

Anchor size			Non-cracked concrete			Cracked concrete		
			M12x80	M16x100	M16x125	M12x80	M16x100	M16x125
Min. base material thickness h_{min} [mm]			160	200	250	160	200	250
Min. spacing s_{min} [mm]			90	100	100	90	100	100
	Tensile N_{Rd}	[kN]	15,7	22,4	29,8	11,2	16,0	21,2
	Shear V_{Rd}	[kN]	27,0	44,9	50,2	23,6	32,0	42,5

Seismic design C1

Basic loading data for concrete C20/25 – C50/60

All data in this section applies to:

- Seismic design according to TR045

The following technical data are based on: ETA-14/0069 issue 2014-04-02

Anchorage depth range

Anchor size§		HMU-PF M12x80	HMU-PF M16x100	HMU-PF M16x125
Effective anchorage depth range	h_{ef} [mm]	80	100	125

Tension resistance in case of seismic performance category C1

Anchor size		HMU-PF M12x80	HMU-PF M16x100	HMU-PF M16x125
Characteristic tension resistance to steel failure				
	$N_{Rk,s,seis}$ [kN]	67,5	125,6	
Partial safety factor	$\gamma_{Ms,seis}$ [-]	1,5		
Characteristic pull-out resistance in cracked concrete C20/25 to C50/60				
	$N_{Rk,p,seis}$ [kN]	17,3	26,8	29,8
Partial safety factor	$\gamma_{Mp,seis}$ [-]	1,5		

Shear resistance in case of seismic performance category C1

Anchor size		HMU-PF M12x80	HMU-PF M16x100	HMU-PF M16x125
Characteristic shear resistance to steel failure				
	$V_{Rk,s,seis}$ [kN]	33,7	62,8	
Partial safety factor	$\gamma_{Ms,seis}$ [-]	1,25		

For seismic resistant fastening applications please use the anchor design software PROFIS Anchor.

HSC-A Safety anchor

	Anchor version	Benefits
	Bolt version	<ul style="list-style-type: none"> - the perfect solution for small edge and space distance - suitable for thin concrete blocks due to low embedment depth - suitable for cracked concrete - self-cutting undercut anchor - available as bolt version for through applications - stainless steel available for external applications
	HSC-A Carbon Steel version	
	HSC-AR Stainless steel version	



Concrete



Tensile zone



Shock

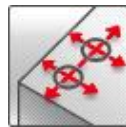

Small edge distance and spacing



Fire resistance

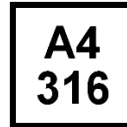

Corrosion resistance



European Technical Approval



CE conformity



PROFIS Anchor design software

Approvals / certificates

Description	Authority / Laboratory	No. / date of issue
European technical approval ^{a)}	CSTB, Paris	ETA-02/0027 / 2012-09-20
Shockproof fastenings in civil defence installations	Federal Office for Civil Protection, Bern	BZS D 06-601 / 2006-07-10
Fire test report	IBMB, Braunschweig	UB 3177/1722-1 / 2006-06-28
Assessment report (fire)	warringtonfire	WF 327804/A / 2013-07-10

a) All data given in this section according ETA-02/0027 issue 2012-09-20.

Basic loading data

All data in this section applies to

- Correct setting (See setting instruction)
- No edge distance and spacing influence
- Concrete as specified in the table
- Steel failure
- Minimum base material thickness
- Concrete C 20/25, $f_{ck,cube} = 25 \text{ N/mm}^2$

For details see Simplified design method

Mean ultimate resistance

Anchor size	Non-cracked concrete				Cracked concrete			
	M8x40	M10x40	M8x50	M12x60	M8x40	M10x40	M8x50	M12x60
Tensile $N_{R_u,m}$								
HSC-A [kN]	16,6	16,6	23,3	30,6	13,3	13,3	18,6	24,5
HSC-AR [kN]	16,6	16,6	23,3	30,6	13,3	13,3	18,6	24,5
Shear $V_{R_u,m}$								
HSC-A [kN]	19,0	30,2	19,0	43,8	19,0	30,2	19,0	43,8
HSC-AR [kN]	16,6	26,4	16,6	38,4	16,6	26,4	16,6	38,4

Characteristic resistance

Anchor size	Non-cracked concrete				Cracked concrete			
	M8x40	M10x40	M8x50	M12x60	M8x40	M10x40	M8x50	M12x60
Tensile N_{R_k}								
HSC-A [kN]	12,8	12,8	17,8	23,4	9,1	9,1	12,7	16,7
HSC-AR [kN]	12,8	12,8	17,8	23,4	9,1	9,1	12,7	16,7
Shear V_{R_k}								
HSC-A [kN]	14,6	23,2	14,6	33,7	14,6	18,2	14,6	33,5
HSC-AR [kN]	12,8	20,3	12,8	29,5	12,8	18,2	12,8	29,5

Design resistance

Anchor size	Non-cracked concrete				Cracked concrete			
	M8x40	M10x40	M8x50	M12x60	M8x40	M10x40	M8x50	M12x60
Tensile N_{R_d}								
HSC-A [kN]	8,5	8,5	11,9	15,6	6,1	6,1	8,5	11,2
HSC-AR [kN]	8,5	8,5	11,9	15,6	6,1	6,1	8,5	11,2
Shear V_{R_d}								
HSC-A [kN]	11,7	17,0	11,7	27,0	11,7	12,1	11,7	22,3
HSC-AR [kN]	8,2	13,0	8,2	18,9	8,2	12,1	8,2	18,9

Recommended loads

Anchor size	Non-cracked concrete				Cracked concrete			
	M8x40	M10x40	M8x50	M12x60	M8x40	M10x40	M8x50	M12x60
Tensile $N_{rec}^{a)}$								
HSC-A [kN]	6,1	6,1	8,5	11,2	4,3	4,3	6,1	8,0
HSC-AR [kN]	6,1	6,1	8,5	11,2	4,3	4,3	6,1	8,0
Shear $V_{rec}^{a)}$								
HSC-A [kN]	8,3	12,1	8,3	19,3	8,3	8,7	8,3	15,9
HSC-AR [kN]	5,9	9,3	5,9	13,5	5,9	8,7	5,9	13,5

a) With overall partial safety factor for action $\gamma = 1,4$. The partial safety factors for action depend on the type of loading and shall be taken from national regulations.

Materials

Mechanical properties

Anchor size	HSC	M8x40	M10x40	M8x50	M12x60
Nominal tensile strength f_{uk} [N/mm ²]	-A	800	800	800	800
	-AR	700	700	700	700
Yield strength f_{yk} [N/mm ²]	-A	640	640	640	640
	-AR	450	450	450	450
Stressed cross-section for bolt version $A_{s,A}$ [mm ²]	-A, AR	36,6	58,0	36,6	84,3
Moment of resistance W [mm ³]	-A, AR	31,2	62,3	31,2	109,2
Design bending resistance without sleeve $M_{Rd,s}$ [Nm]	-A	24	48	24	84
	-AR	16,7	33,3	16,7	59,0

Material quality

Part		Material
Carbon steel		
HSC-A	Cone bolt with , with internal or external thread	steel strength 8.8, galvanised to min. 5 µm
	Expansion sleeve and washer	Galvanised steel
	Hexagon nut	Strength 8
Sainless steel		
HSC-AR	Cone bolt with , with internal or external thread	steel grade 1.4401, 1.4571 A4-70
	Expansion sleeve and washer	steel grade 1.4401, 1.4571
	Hexagon nut	steel grade 1.4401, 1.4571 A4-70

Anchor dimensions

Dimensions of HSC-A and HSC-AR

Anchor version	Thread size	t_{fix} [mm] max	b [mm]	l_s [mm]	d [mm]	e [mm]
HSC-A(R) M8x40	M8	150	13,5	40,8	13,5	16
HSC-A(R) M10x40	M10	200	15,5	40,8	15,5	20
HSC-A(R) M8x50	M8	150	13,5	50,8	13,5	16
HSC-A(R) M12x60	M12	200	17,5	60,8	17,5	24

marking HILTI 8.8 (or A4)

marking e.g. HSC-A M8 x 40 / t_{fix} (or HSC-AR M8 x 40 / t_{fix} A4)

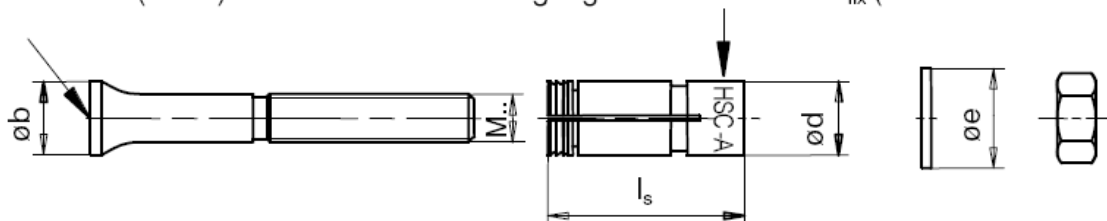

Setting

Installation equipment

Anchor size	HSC-A/AR M8x40	HSC-A/AR M8x50	HSC-A/AR M10x40	HSC-A/AR M12x60
Rotary hammer for setting	TE 7-C; TE 7-A; TE 16; TE 16-C; TE 16-M; TE 25; TE 30; TE 35		TE 7-C; TE 7-A; TE 25; TE 35	TE 16; TE 16-C; TE 16-M; TE 25; TE 30; TE 35; TE 40; TE 40-AVR
Stop drill bit	TE-C-HSC-B 14x40	14x50	16x40	18x60
Setting Tool	TE-C-HSC-MW 14	14	16	18

Setting instruction

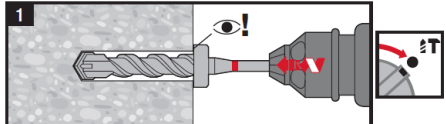

1.1 HSC-A/AR

	TE 7 TE 7-A	TE 16 TE 30	TE 25 TE 35	TE 40
M8 x 40/15	✓	✓	✓	
M8 x 50/15	✓	✓	✓	
M10 x 40/20	✓	✓	✓	✓
M12 x 60/20		✓	✓	✓

1.2 HSC-A/AR

	TE-C-HSC-B
M8 x 40/15	14 x 40
M8 x 50/15	14 x 50
M10 x 40/20	16 x 40
M12 x 60/20	18 x 60

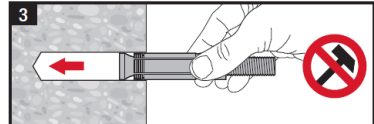

3

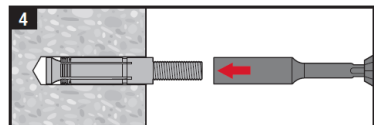

4

4.1 HSC-A/AR

	TE-C-HSC-MW
M8 x 40/15	14
M8 x 50/15	14
M10 x 40/20	16
M12 x 60/20	18

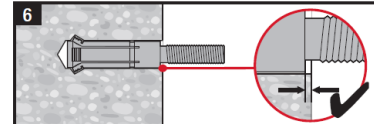

6

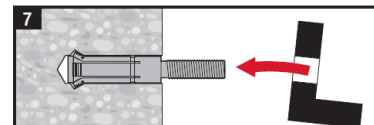

7

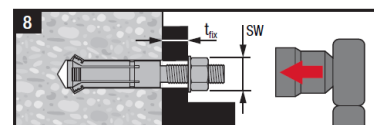

8

8.1 HSC-A/AR

	t _{fix}	SW	T _{inst}
M8 x 40/15	15	13	10 Nm
M8 x 50/15	15	13	10 Nm
M10 x 40/20	20	17	20 Nm
M12 x 60/20	20	19	30 Nm

For detailed information on installation see instruction for use given with the package of the product.

Setting details: depth of drill hole h_1 and effective anchorage depth h_{ef}

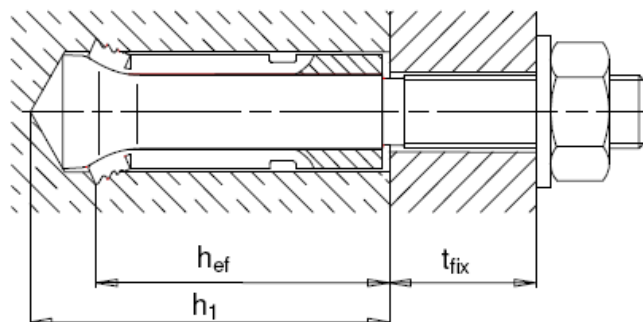

Setting details HSC-A (R)

Anchor version			M8x40	M10x40	M8x50	M12x60
Nominal diameter of drill bit	d_o	[mm]	14	16	14	18
Cutting diameter of drill bit	$d_{cut} \leq$	[mm]	14,5	16,5	14,5	18,5
Depth of drill hole	$h_1 \geq$	[mm]	46	46	56	68
Diameter of clearance hole in the fixture	$d_f \leq$	[mm]	9	12	10	30
Effective anchorage depth	h_{ef}	[mm]	40	40	50	60
Maximum fastening thickness	t_{fix}	[mm]	15	20	15	20
Torque moment	T_{inst}	[Nm]	10	20	10	30
Width across	SW	[mm]	13	17	13	19

Base material thickness, anchor spacing and edge distance

Anchor size			M8x40	M10x40	M8x50	M12x60
Minimum base material thickness	h_{min}	[mm]	100	100	100	130
Minimum spacing	s_{min}	[mm]	40	40	50	60
Minimum edge distance	c_{min}	[mm]	40	40	50	60
Critical spacing for concrete cone failure	$s_{cr,N}$	[mm]	120	120	150	180
Critical edge distance for concrete cone failure	$c_{cr,N}$	[mm]	60	60	75	90
Critical spacing for splitting failure	$s_{cr,sp}$	[mm]	130	120	170	180
Critical edge distance for splitting failure	$c_{cr,sp}$	[mm]	65	60	85	90

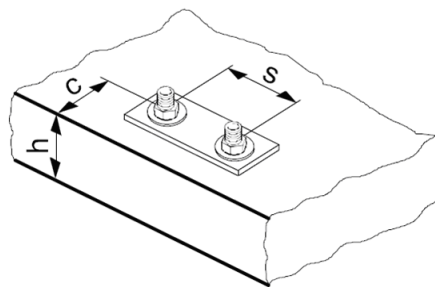

For spacing (edge distance) smaller than critical spacing (critical edge distance) the design loads have to be reduced.

Critical spacing and critical edge distance for splitting failure apply only for non-cracked concrete. For cracked concrete only the critical spacing and critical edge distance for concrete cone failure are decisive.

Simplified design method

Simplified version of the design method according ETAG 001, Annex C. Design resistance according data given in ETA-02/0027 issue 2012-09-20.

- Influence of concrete strength
- Influence of edge distance
- Influence of spacing
- Valid for a group of two anchors. (The method may also be applied for anchor groups with more than two anchors or more than one edge. The influencing factors must then be considered for each edge distance and spacing. The calculated design loads are then on the save side: They will be lower than the exact values according ETAG 001, Annex C. To avoid this, it is recommended to use the anchor design software PROFIS anchor)

The design method is based on the following simplification:

- No different loads are acting on individual anchors (no eccentricity)

The values are valid for one anchor.

For more complex fastening applications please use the anchor design software PROFIS Anchor.

Tension loading

The design tensile resistance is the lower value of

- Steel resistance: $N_{Rd,s}$
- Concrete pull-out resistance: $N_{Rd,p} = N_{Rd,p}^0 \cdot f_B$
- Concrete cone resistance: $N_{Rd,c} = N_{Rd,c}^0 \cdot f_B \cdot f_{1,N} \cdot f_{2,N} \cdot f_{3,N} \cdot f_{re,N}$
- Concrete splitting resistance (only non-cracked concrete):
 $N_{Rd,sp} = N_{Rd,c}^0 \cdot f_B \cdot f_{1,sp} \cdot f_{2,sp} \cdot f_{3,sp} \cdot f_{h,sp} \cdot f_{re,N}$

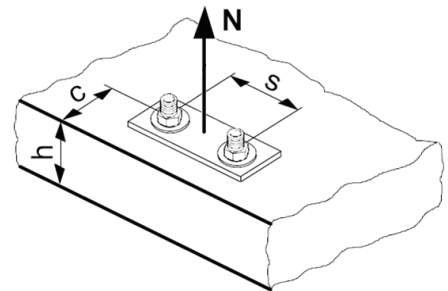

Basic design tensile resistance

Design steel resistance $N_{Rd,s}$

Anchor size		M8x40	M10x40	M8x50	M12x60
$N_{Rd,s}$	HSC-A [kN]	19,5	30,9	19,5	44,9
	HSC-AR [kN]	13,7	21,7	13,7	31,6

Design pull-out resistance $N_{Rd,p} = N_{Rd,p}^0 \cdot f_B$ for HSC-A and HSC-AR

Anchor size	[kN]	Non-cracked concrete				Cracked concrete			
		M8x40	M10x40	M8x50	M12x60	M8x40	M10x40	M8x50	M12x60
$N_{Rd,p}^0$	[kN]	No pull-out failure				No pull-out failure			

Design concrete cone resistance $N_{Rd,c} = N_{Rd,c}^0 \cdot f_B \cdot f_{1,N} \cdot f_{2,N} \cdot f_{3,N} \cdot f_{re,N}$

Design splitting resistance ^{a)} $N_{Rd,sp} = N_{Rd,c}^0 \cdot f_B \cdot f_{1,sp} \cdot f_{2,sp} \cdot f_{3,sp} \cdot f_{h,sp} \cdot f_{re,N}$

Anchor size	[kN]	Non-cracked concrete				Cracked concrete			
		M8x40	M10x40	M8x50	M12x60	M8x40	M10x40	M8x50	M12x60
$N_{Rd,c}^0$	[kN]	8,5	8,5	11,9	15,6	6,1	6,1	8,5	11,2

a) Splitting resistance must only be considered for non-cracked concrete

Influencing factors

Influence of concrete strength

Concrete strength designation (ENV 206)	C 20/25	C 25/30	C 30/37	C 35/45	C 40/50	C 45/55	C 50/60
$f_B = (f_{ck,cube}/25N/mm^2)^{1/2}$ ^{a)}	1	1,1	1,22	1,34	1,41	1,48	1,55

a) $f_{ck,cube}$ = concrete compressive strength, measured on cubes with 150 mm side length

Influence of edge distance ^{a)}

$c/c_{cr,N}$	0,1	0,2	0,3	0,4	0,5	0,6	0,7	0,8	0,9	1
$c/c_{cr,sp}$										
$f_{1,N} = 0,7 + 0,3 \cdot c/c_{cr,N} \leq 1$	0,73	0,76	0,79	0,82	0,85	0,88	0,91	0,94	0,97	1
$f_{1,sp} = 0,7 + 0,3 \cdot c/c_{cr,sp} \leq 1$										
$f_{2,N} = 0,5 \cdot (1 + c/c_{cr,N}) \leq 1$	0,55	0,60	0,65	0,70	0,75	0,80	0,85	0,90	0,95	1
$f_{2,sp} = 0,5 \cdot (1 + c/c_{cr,sp}) \leq 1$										

a) The edge distance shall not be smaller than the minimum edge distance c_{min} given in the table with the setting details. These influencing factors must be considered for every edge distance.

Influence of anchor spacing ^{a)}

$s/s_{cr,N}$	0,1	0,2	0,3	0,4	0,5	0,6	0,7	0,8	0,9	1
$s/s_{cr,sp}$										
$f_{3,N} = 0,5 \cdot (1 + s/s_{cr,N}) \leq 1$	0,55	0,60	0,65	0,70	0,75	0,80	0,85	0,90	0,95	1
$f_{3,sp} = 0,5 \cdot (1 + s/s_{cr,sp}) \leq 1$										

a) The anchor spacing shall not be smaller than the minimum anchor spacing s_{min} given in the table with the setting details. This influencing factor must be considered for every anchor spacing.

Influence of base material thickness

h/h_{ef}	2,0	2,2	2,4	2,6	2,8	3,0	3,2	3,4	3,6	≥ 3,68
$f_{h,sp} = [h/(2 \cdot h_{ef})]^{2/3}$	1	1,07	1,13	1,19	1,25	1,31	1,37	1,42	1,48	1,5

Influence of reinforcement

Anchor size	M8x40	M10x40	M8x50	M12x60
$f_{re,N} = 0,5 + h_{ef}/200mm \leq 1$	0,7 ^{a)}	0,7 ^{a)}	0,75 ^{a)}	0,8 ^{a)}

a) This factor applies only for dense reinforcement. If in the area of anchorage there is reinforcement with a spacing ≥ 150 mm (any diameter) or with a diameter ≤ 10 mm and a spacing ≥ 100 mm, then a factor $f_{re,N} = 1$ may be applied.

Shear loading

The design shear resistance is the lower value of

- Steel resistance: $V_{Rd,s}$
- Concrete pryout resistance: $V_{Rd,cp} = k \cdot N_{Rd,c}$
- Concrete edge resistance: $V_{Rd,c} = V_{Rd,c}^0 \cdot f_B \cdot f_{\beta} \cdot f_h \cdot f_4 \cdot f_{hef} \cdot f_c$

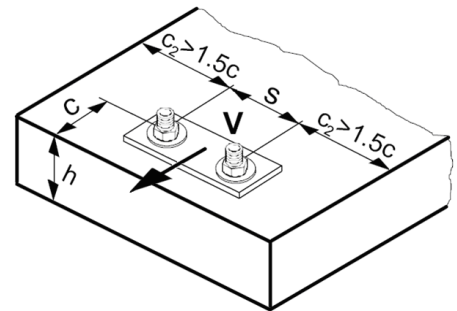

Basic design shear resistance

Design steel resistance $V_{Rd,s}$

Anchor size		M8x40	M10x40	M8x50	M12x60
$V_{Rd,s}$	HSC-A [kN]	11,7	18,6	11,7	27,0
	HSC-AR [kN]	8,2	13,0	8,2	18,9

Design concrete pryout resistance $V_{Rd,cp} = k \cdot N_{Rd,c}^a$

Anchor size	M8x40	M10x40	M8x50	M12x60
k	2,0			

a) $N_{Rd,c}$: Design concrete cone resistance

Design concrete edge resistance $V_{Rd,c}^a = V_{Rd,c}^0 \cdot f_B \cdot f_{\beta} \cdot f_h \cdot f_4 \cdot f_{hef} \cdot f_c$

Anchor size	Non-cracked concrete				Cracked concrete			
	M8x40	M10x40	M8x50	M12x60	M8x40	M10x40	M8x50	M12x60
$V_{Rd,c}^0$ [kN]	14,9	18,5	15,0	22,7	10,5	13,1	10,6	16,1

a) For anchor groups only the anchors close to the edge must be considered.

Influencing factors

Influence of concrete strength

Concrete strength designation (ENV 206)	C 20/25	C 25/30	C 30/37	C 35/45	C 40/50	C 45/55	C 50/60
$f_B = (f_{ck,cube}/25N/mm^2)^{1/2}$ a)	1	1,1	1,22	1,34	1,41	1,48	1,55

a) $f_{ck,cube}$ = concrete compressive strength, measured on cubes with 150 mm side length

Influence of angle between load applied and the direction perpendicular to the free edge

Angle β	0°	10°	20°	30°	40°	50°	60°	70°	80°	≥ 90°
$f_{\beta} = \sqrt{\frac{1}{(\cos \alpha_V)^2 + \left(\frac{\sin \alpha_V}{2,5}\right)^2}}$	1	1,01	1,05	1,13	1,24	1,40	1,64	1,97	2,32	2,50

Influence of base material thickness

h/c	0,15	0,3	0,45	0,6	0,75	0,9	1,05	1,2	1,35	≥ 1,5
$f_h = \{h/(1,5 \cdot c)\}^{1/2} \leq 1$	0,32	0,45	0,55	0,63	0,71	0,77	0,84	0,89	0,95	1,00

Influence of anchor spacing and edge distance ^{a)} for concrete edge resistance: f_4

$$f_4 = (c/h_{ef})^{1,5} \cdot (1 + s / [3 \cdot c]) \cdot 0,5$$

c/h _{ef}	Single anchor	Group of two anchors s/h _{ef}														
		0,75	1,50	2,25	3,00	3,75	4,50	5,25	6,00	6,75	7,50	8,25	9,00	9,75	10,50	11,25
0,50	0,35	0,27	0,35	0,35	0,35	0,35	0,35	0,35	0,35	0,35	0,35	0,35	0,35	0,35	0,35	0,35
0,75	0,65	0,43	0,54	0,65	0,65	0,65	0,65	0,65	0,65	0,65	0,65	0,65	0,65	0,65	0,65	0,65
1,00	1,00	0,63	0,75	0,88	1,00	1,00	1,00	1,00	1,00	1,00	1,00	1,00	1,00	1,00	1,00	1,00
1,25	1,40	0,84	0,98	1,12	1,26	1,40	1,40	1,40	1,40	1,40	1,40	1,40	1,40	1,40	1,40	1,40
1,50	1,84	1,07	1,22	1,38	1,53	1,68	1,84	1,84	1,84	1,84	1,84	1,84	1,84	1,84	1,84	1,84
1,75	2,32	1,32	1,49	1,65	1,82	1,98	2,15	2,32	2,32	2,32	2,32	2,32	2,32	2,32	2,32	2,32
2,00	2,83	1,59	1,77	1,94	2,12	2,30	2,47	2,65	2,83	2,83	2,83	2,83	2,83	2,83	2,83	2,83
2,25	3,38	1,88	2,06	2,25	2,44	2,63	2,81	3,00	3,19	3,38	3,38	3,38	3,38	3,38	3,38	3,38
2,50	3,95	2,17	2,37	2,57	2,77	2,96	3,16	3,36	3,56	3,76	3,95	3,95	3,95	3,95	3,95	3,95
2,75	4,56	2,49	2,69	2,90	3,11	3,32	3,52	3,73	3,94	4,15	4,35	4,56	4,56	4,56	4,56	4,56
3,00	5,20	2,81	3,03	3,25	3,46	3,68	3,90	4,11	4,33	4,55	4,76	4,98	5,20	5,20	5,20	5,20
3,25	5,86	3,15	3,38	3,61	3,83	4,06	4,28	4,51	4,73	4,96	5,18	5,41	5,63	5,86	5,86	5,86
3,50	6,55	3,51	3,74	3,98	4,21	4,44	4,68	4,91	5,14	5,38	5,61	5,85	6,08	6,31	6,55	6,55
3,75	7,26	3,87	4,12	4,36	4,60	4,84	5,08	5,33	5,57	5,81	6,05	6,29	6,54	6,78	7,02	7,26
4,00	8,00	4,25	4,50	4,75	5,00	5,25	5,50	5,75	6,00	6,25	6,50	6,75	7,00	7,25	7,50	7,75
4,25	8,76	4,64	4,90	5,15	5,41	5,67	5,93	6,18	6,44	6,70	6,96	7,22	7,47	7,73	7,99	8,25
4,50	9,55	5,04	5,30	5,57	5,83	6,10	6,36	6,63	6,89	7,16	7,42	7,69	7,95	8,22	8,49	8,75
4,75	10,35	5,45	5,72	5,99	6,27	6,54	6,81	7,08	7,36	7,63	7,90	8,17	8,45	8,72	8,99	9,26
5,00	11,18	5,87	6,15	6,43	6,71	6,99	7,27	7,55	7,83	8,11	8,39	8,66	8,94	9,22	9,50	9,78
5,25	12,03	6,30	6,59	6,87	7,16	7,45	7,73	8,02	8,31	8,59	8,88	9,17	9,45	9,74	10,02	10,31
5,50	12,90	6,74	7,04	7,33	7,62	7,92	8,21	8,50	8,79	9,09	9,38	9,67	9,97	10,26	10,55	10,85

- a) The anchor spacing and the edge distance shall not be smaller than the minimum anchor spacing s_{min} and the minimum edge distance c_{min} .

Influence of embedment depth

Anchor size	M8x40	M10x40	M8x50	M12x60
$f_{hef} = 0,05 \cdot (h_{ef} / d)^{1,68}$	0,29	0,23	0,42	0,38

Influence of edge distance ^{a)}

c/d	4	6	8	10	15	20	30	40
$f_c = (d / c)^{0,19}$	0,77	0,71	0,67	0,65	0,60	0,57	0,52	0,50

- a) The edge distance shall not be smaller than the minimum edge distance c_{min} .

Combined tension and shear loading

For combined tension and shear loading see section "Anchor Design".

Precalculated values

Design resistance calculated according ETAG 001, Annex C and data given in ETA-02/0027, issue 2012-09-20.
All data applies to concrete C 20/25 – $f_{ck,cube} = 25 \text{ N/mm}^2$.

Recommended loads can be calculated by dividing the design resistance by an overall partial safety factor for action $\gamma = 1,4$. The partial safety factors for action depend on the type of loading and shall be taken from national regulations.

Design resistance

Single anchor, no edge effects

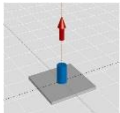
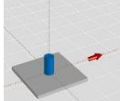
Anchor size		Non-cracked concrete				Cracked concrete				
		M8x40	M10x40	M8x50	M12x60	M6x40	M8x40	M10x50	M10x60	
Min. base material thickness h_{min} [mm]		100	100	100	130	100	100	100	130	
	Tensile N_{Rd}									
	HSC-A HSC-AR	[kN]	8,5	8,5	11,9	15,6	6,1	6,1	8,5	11,2
	Shear V_{Rd}, without lever arm									
	HSC-A	[kN]	11,7	17,0	11,7	27,0	11,7	12,1	11,7	22,3
	HSC-AR	[kN]	8,2	13,0	8,2	18,9	8,2	12,1	8,2	18,9

Single anchor, min. edge distance ($c = c_{min}$)

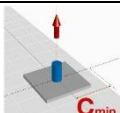
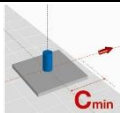
Anchor size		Non-cracked concrete				Cracked concrete			
		M8x40	M10x40	M8x50	M12x60	M6x40	M8x40	M10x50	M10x60
Min. base material thickness h_{min} [mm]		100	100	100	130	100	100	100	130
Min. edge distance c_{min} [mm]		40	40	50	60	40	40	50	60
	Tensile N_{Rd}								
	HSC-A HSC-AR	[kN]	6,1	6,4	8,3	11,7	4,6	4,6	6,4
	Shear V_{Rd}, without lever arm								
	HSC-A HSC-AR	[kN]	3,6	3,6	5,0	6,8	2,5	2,6	3,5

Double anchor, no edge effects, min. spacing ($s = s_{min}$), (load values are valid for one anchor)

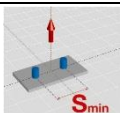
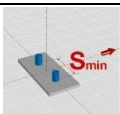
Anchor size		Non-cracked concrete				Cracked concrete			
		M8x40	M10x40	M8x50	M12x60	M8x40	M10x40	M8x50	M12x60
Min. base material thickness h_{min} [mm]		100	100	100	130	100	100	100	130
Min. spacing s_{min} [mm]		40	40	50	60	40	40	50	60
	Tensile N_{Rd}								
	HSC-A HSC-AR	[kN]	5,6	5,7	7,7	10,4	4,0	4,0	5,7
	Shear V_{Rd}, without lever arm								
	HSC-A HSC-AR	[kN]	11,3	11,3	11,7	20,8	8,1	8,1	11,3

HSC-I Safety anchor

	Anchor version	Benefits
	Internal threaded version: HSC-I carbon steel internal version HSC-IR Stainless steel version ((A4))	<ul style="list-style-type: none"> - the perfect solution for small edge and space distance - suitable for thin concrete blocks due to low embedment depth - suitable for cracked concrete - self-cutting undercut anchor - internal threaded - stainless steel available for external applications



Concrete



Tensile zone



Shock

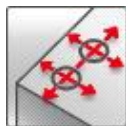

Small edge distance and spacing



Fire resistance

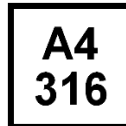

Corrosion resistance



European Technical Approval



CE conformity



PROFIS Anchor design software

Approvals / certificates

Description	Authority / Laboratory	No. / date of issue
European technical approval ^{a)}	CSTB, Paris	ETA-02/0027 / 2012-09-20
Shockproof fastenings in civil defence installations	Federal Office for Civil Protection, Bern	BZS D 06-601 / 2006-07-10
Fire test report	IBMB, Braunschweig	UB 3177/1722-1 / 2006-06-28
Assessment report (fire)	warringtonfire	WF 327804/A / 2013-07-10

- All data given in this section according ETA-02/0027 issue 2012-09-20.

Basic loading data

All data in this section applies to

- Correct setting (See setting instruction)
- No edge distance and spacing influence
- Concrete as specified in the table
- Steel failure
- Minimum base material thickness
- Concrete C 20/25, $f_{ck,cube} = 25 \text{ N/mm}^2$

For details see Simplified design method

Mean ultimate resistance HSC-I and HSC-IR

Anchor size	Non-cracked concrete					Cracked concrete				
	M6x 40	M8x 40	M10x 50	M10x 60	M12x 60	M6x 40	M8x 40	M10x 50	M10x 60	M12x 60
Tensile $N_{Ru,m}$										
HSC-I [kN]	16,6	16,6	23,3	30,6	30,6	13,3	13,3	18,6	24,5	24,5
HSC-IR [kN]	14,8	16,6	23,3	30,6	30,6	13,3	13,3	18,6	24,5	24,5
Shear $V_{Ru,m}$										
HSC-I [kN]	10,4	15,9	19,8	19,8	23,4	10,4	15,9	19,8	19,8	23,4
HSC-IR [kN]	9,1	13,9	17,3	17,3	20,8	9,1	13,9	17,3	17,3	20,8

Characteristic resistance HSC-I and HSC-IR

Anchor size	Non-cracked concrete					Cracked concrete				
	M6x 40	M8x 40	M10x 50	M10x 60	M12x 60	M6x 40	M8x 40	M10x 50	M10x 60	M12x 60
Tensile N_{Rk}										
HSC-I [kN]	12,8	12,8	17,8	23,4	23,4	9,1	9,1	12,7	16,7	16,7
HSC-IR [kN]	12,8	12,8	17,8	23,4	23,4	9,1	9,1	12,7	16,7	16,7
Shear V_{Rk}										
HSC-I [kN]	8,0	12,2	15,2	15,2	18,2	8,0	12,2	15,2	15,2	18,2
HSC-IR [kN]	7,0	10,7	13,3	13,3	16,0	7,0	10,7	13,3	13,3	16,0

Design resistance HSC-I and HSC-IR

Anchor size	Non-cracked concrete					Cracked concrete				
	M6x 40	M8x 40	M10x 50	M10x 60	M12x 60	M6x 40	M8x 40	M10x 50	M10x 60	M12x 60
Tensile N_{Rd}										
HSC-I [kN]	8,5	8,5	11,9	15,6	15,6	6,1	6,1	8,5	11,2	11,2
HSC-IR [kN]	7,5	8,5	11,9	14,2	15,6	6,1	6,1	8,5	11,2	11,2
Shear V_{Rd}										
HSC-I [kN]	6,4	9,8	12,2	12,2	14,6	6,4	9,8	12,2	12,2	14,6
HSC-IR [kN]	4,5	6,9	8,5	8,5	10,3	4,5	6,9	8,5	8,5	10,3

Recommended loads HSC-I and HSC-IR

Anchor size	Non-cracked concrete					Cracked concrete				
	M6x 40	M8x 40	M10x 50	M10x 60	M12x 60	M6x 40	M8x 40	M10x 50	M10x 60	M12x 60
Tensile $N_{rec}^a)$										
HSC-I [kN]	6,1	6,1	8,5	11,2	11,2	4,3	4,3	6,1	8,0	8,0
HSC-IR [kN]	5,4	6,1	8,5	10,1	11,2	4,3	4,3	6,1	8,0	8,0
Shear $V_{rec}^a)$										
HSC-I [kN]	4,6	7,0	8,7	8,7	10,4	4,6	7,0	8,7	8,7	10,4
HSC-IR [kN]	3,2	4,9	6,1	6,1	7,3	3,2	4,9	6,1	6,1	7,3

- With overall partial safety factor for action $\gamma = 1,4$. The partial safety factors for action depend on the type of loading and shall be taken from national regulations.

Materials
Mechanical properties

Anchor size	HSC	M6x40	M8x40	M10x50	M10x60	M12x60
Nominal tensile strength f_{uk} [N/mm ²]	-I	800	800	800	800	800
	-IR	600	600	700	700	700
Yield strength f_{yk} [N/mm ²]	-I	640	640	640	640	640
	-IR	355	355	350	350	340
Stressed cross-section for internal threaded version $A_{s,I}$ [mm ²]	-I,IR	22,0	28,3	34,6	34,6	40,8
Stressed cross-section for bolt version $A_{s,A}$ [mm ²]	-I,IR	20,1	36,6	58,0	58,0	84,3
Moment of resistance W [mm ³]	-I,IR	12,7	31,2	62,3	62,3	109,2
Design bending resistance without sleeve $M_{Rd,s}$ [Nm]	-I	9,6	24	48	48	84
	-IR	7,1	16,7	33,3	33,3	59,0

Material quality

Part	Material	
Carbon steel		
HSC-I	Cone bolt with , with internal or external thread	steel strength 8.8, galvanised to min. 5 µm
	Expansion sleeve and washer	Galvanised steel
	Hexagon nut	Strength 8
Stainless steel		
HSC-IR	Cone bolt with , with internal or external thread	steel grade 1.4401, 1.4571 A4-70
	Expansion sleeve and washer	steel grade 1.4401, 1.4571
	Hexagon nut	steel grade 1.4401, 1.4571 A4-70

Anchor dimensions

Dimensions of HSC-I and HSC-IR

Anchor version	Thread size	b [mm]	l _s [mm]	d [mm]	l _b [mm]
HSC-I(R) M6x40	M6	13,5	40,8	13,5	43,3
HSC-I(R) M8x40	M8	15,5	40,8	15,5	43,8
HSC-I(R) M10x50	M10	17,5	50,8	17,5	54,8
HSC-I(R) M10x60	M10	17,5	60,8	17,5	64,8
HSC-I(R) M12x60	M12	19,5	60,8	19,5	64,8

marking HILTI 8.8 (or A4)

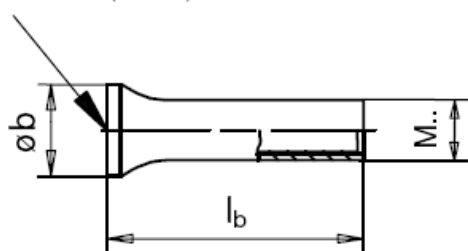

marking e.g. HSC-I M6 x 40 (or HSC-IR M6 x 40 A4)

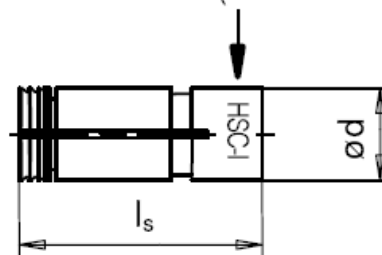

Setting

Installation equipment

Anchor size		HSC-I/IR M6x40	HSC-I/IR M8x40	HSC-I/IR M10x50	HSC-I/IR M10x60	HSC-I/IR M12x60
Rotary hammer for setting		TE 7-C; TE 7-A; TE 16; TE 16-C; TE 16-M; TE 25; TE 30; TE 35				TE 16; TE 16-C; TE 16-M; TE 25; TE 30; TE 35; TE 40; TE 40-AVR
Stop drill bit	TE-C HSC-B	14x40	16x40	18x50	18x60	20x60
Setting Tool	TE-C HSC-MW	14	16	18	18	20
Insert Tool	TE-C HSC-EW	14	16	18	18	20

Setting instruction

1

1.1

HSC-I/IR	TE 7 TE 7-A	TE 16 TE 30	TE 25 TE 35	TE 40
M6 × 40	✓	✓	✓	
M8 × 40	✓	✓	✓	
M10 × 50	✓	✓	✓	
M10 × 60	✓	✓	✓	
M12 × 60		✓	✓	✓

1.2

HSC-I/IR	TE-C-HSC-B
M6 × 40	14 × 40
M8 × 40	16 × 40
M10 × 50	18 × 50
M10 × 60	18 × 60
M12 × 60	20 × 60

2

3

4

4.1

4.2

HSC-I/IR	EW	TE-C-HSC-MW
M6 × 40	14	14
M8 × 40	16	16
M10 × 50	18	18
M10 × 60	18	18
M12 × 60	20	20

5

6

7

8

8.1

HSC-I/IR	L
M6	6 ... 16 mm
M8	8 ... 22 mm
M10	10 ... 28 mm
M12	12 ... 30 mm

9

9.1

HSC-I/IR	SW	T _{inst}
M6 × 40	10	10 Nm
M8 × 40	13	10 Nm
M10 × 50	17	20 Nm
M10 × 60	17	30 Nm
M12 × 60	19	30 Nm

For HSC-I: fastening carbon steel screw or threaded rod. Minimum strength class 8.8

For HSC-IR: fastening stainless steel screw or threaded rod: minimum strength class A4-70

For detailed information on installation see instruction for use given with the package of the product.

Setting details: depth of drill hole h_1 and effective anchorage depth h_{ef}

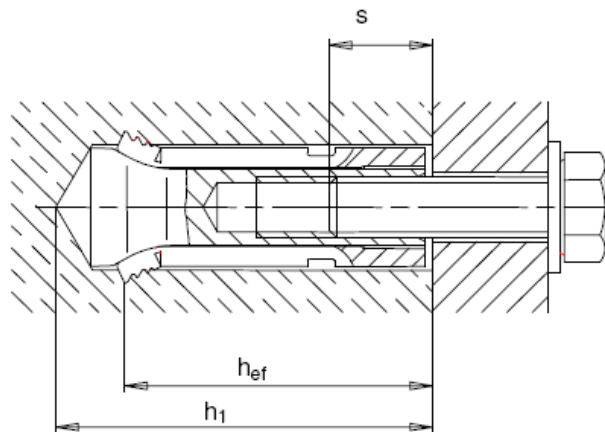

Setting details

Anchor version		M6x40	M8x40	M10x50	M10x60	M12x60
Nominal diameter of drill bit	d_0 [mm]	14	16	18	18	20
Cutting diameter of drill bit	$d_{cut} \leq$ [mm]	14,5	16,5	18,5	18,5	20,5
Depth of drill hole	$h_1 \geq$ [mm]	46	46	56	68	68
Diameter of clearance hole in the fixture	$d_f \leq$ [mm]	7	9	12	12	14
Effective anchorage depth	h_{ef} [mm]	40	40	50	60	60
Screwing depth	min s [mm]	6	8	10	10	12
	max s [mm]	16	22	28	28	30
Width across	SW [mm]	10	13	17	17	19
Installation torque	T_{inst} [Nm]	10	10	20	30	30

Base material thickness, anchor spacing and edge distance

Anchor size		M6x40	M8x40	M10x50	M10x60	M12x60
Minimum base material thickness	h_{min} [mm]	100	100	110	130	130
Minimum spacing	s_{min} [mm]	40	40	50	60	60
Minimum edge distance	c_{min} [mm]	40	40	50	60	60
Critical spacing for concrete cone failure	$s_{cr,N}$ [mm]	120	120	150	180	180
Critical edge distance for concrete cone failure	$c_{cr,N}$ [mm]	60	60	75	90	90
Critical spacing for splitting failure	$s_{cr,sp}$ [mm]	130	120	170	180	180
Critical edge distance for splitting failure	$c_{cr,sp}$ [mm]	65	60	85	90	90

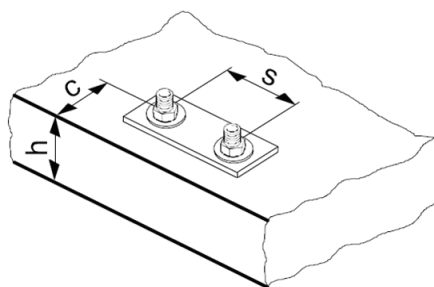

For spacing (edge distance) smaller than critical spacing (critical edge distance) the design loads have to be reduced.

Critical spacing and critical edge distance for splitting failure apply only for non-cracked concrete. For cracked concrete only the critical spacing and critical edge distance for concrete cone failure are decisive.

Simplified design method

Simplified version of the design method according ETAG 001, Annex C. Design resistance according data given in ETA-02/0027 issue 2012-09-20.

- Influence of concrete strength
- Influence of edge distance
- Influence of spacing
- Valid for a group of two anchors. (The method may also be applied for anchor groups with more than two anchors or more than one edge. The influencing factors must then be considered for each edge distance and spacing. The calculated design loads are then on the save side: They will be lower than the exact values according ETAG 001, Annex C. To avoid this, it is recommended to use the anchor design software PROFIS anchor)

The design method is based on the following simplification:

- No different loads are acting on individual anchors (no eccentricity)

The values are valid for one anchor.

For more complex fastening applications please use the anchor design software PROFIS Anchor.

Tension loading

The design tensile resistance is the lower value of

- Steel resistance: $N_{Rd,s}$
- Concrete pull-out resistance: $N_{Rd,p} = N_{Rd,p}^0 \cdot f_B$
- Concrete cone resistance: $N_{Rd,c} = N_{Rd,c}^0 \cdot f_B \cdot f_{1,N} \cdot f_{2,N} \cdot f_{3,N} \cdot f_{re,N}$
- Concrete splitting resistance (only non-cracked concrete):
 $N_{Rd,sp} = N_{Rd,c}^0 \cdot f_B \cdot f_{1,sp} \cdot f_{2,sp} \cdot f_{3,sp} \cdot f_{h,sp} \cdot f_{re,N}$

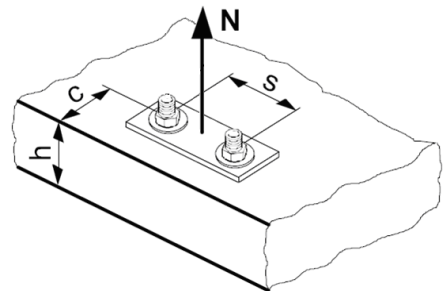

Basic design tensile resistance

Design steel resistance $N_{Rd,s}$

Anchor size		M6x40	M8x40	M10x50	M10x60	M12x60
$N_{Rd,s}$	HSC-I [kN]	10,7	16,3	20,2	20,2	24,3
	HSC-IR [kN]	7,5	11,4	14,2	14,2	17,1

Design pull-out resistance $N_{Rd,p} = N_{Rd,p}^0 \cdot f_B$

Anchor size	Non-cracked concrete					Cracked concrete				
	M6x 40	M8x 40	M10x 50	M10x 60	M12x 60	M6x 40	M8x 40	M10x 50	M10x 60	M12x 60
$N_{Rd,p}^0$ [kN]	No pull-out failure					No pull-out failure				

Design concrete cone resistance $N_{Rd,c} = N_{Rd,c}^0 \cdot f_B \cdot f_{1,N} \cdot f_{2,N} \cdot f_{3,N} \cdot f_{re,N}$

Design splitting resistance ^{a)} $N_{Rd,sp} = N_{Rd,c}^0 \cdot f_B \cdot f_{1,sp} \cdot f_{2,sp} \cdot f_{3,sp} \cdot f_{h,sp} \cdot f_{re,N}$

Anchor size	Non-cracked concrete					Cracked concrete				
	M6x 40	M8x 40	M10x 50	M10x 60	M12x 60	M6x 40	M8x 40	M10x 50	M10x 60	M12x 60
$N_{Rd,c}^0$ [kN]	8,5	8,5	11,9	15,6	15,6	6,1	6,1	8,5	11,2	11,2

- Splitting resistance must only be considered for non-cracked concrete

Influencing factors

Influence of concrete strength

Concrete strength designation (ENV 206)	C 20/25	C 25/30	C 30/37	C 35/45	C 40/50	C 45/55	C 50/60
$f_B = (f_{ck,cube}/25N/mm^2)^{1/2 \text{ a)}$	1	1,1	1,22	1,34	1,41	1,48	1,55

- $f_{ck,cube}$ = concrete compressive strength, measured on cubes with 150 mm side length

Influence of edge distance ^{a)}

$c/c_{cr,N}$	0,1	0,2	0,3	0,4	0,5	0,6	0,7	0,8	0,9	1
$c/c_{cr,sp}$										
$f_{1,N} = 0,7 + 0,3 \cdot c/c_{cr,N} \leq 1$	0,73	0,76	0,79	0,82	0,85	0,88	0,91	0,94	0,97	1
$f_{1,sp} = 0,7 + 0,3 \cdot c/c_{cr,sp} \leq 1$										
$f_{2,N} = 0,5 \cdot (1 + c/c_{cr,N}) \leq 1$	0,55	0,60	0,65	0,70	0,75	0,80	0,85	0,90	0,95	1
$f_{2,sp} = 0,5 \cdot (1 + c/c_{cr,sp}) \leq 1$										

- The edge distance shall not be smaller than the minimum edge distance c_{min} given in the table with the setting details. These influencing factors must be considered for every edge distance.

Influence of anchor spacing ^{a)}

$s/s_{cr,N}$	0,1	0,2	0,3	0,4	0,5	0,6	0,7	0,8	0,9	1
$s/s_{cr,sp}$										
$f_{3,N} = 0,5 \cdot (1 + s/s_{cr,N}) \leq 1$	0,55	0,60	0,65	0,70	0,75	0,80	0,85	0,90	0,95	1
$f_{3,sp} = 0,5 \cdot (1 + s/s_{cr,sp}) \leq 1$										

- The anchor spacing shall not be smaller than the minimum anchor spacing s_{min} given in the table with the setting details. This influencing factor must be considered for every anchor spacing.

Influence of base material thickness

h/h_{ef}	2,0	2,2	2,4	2,6	2,8	3,0	3,2	3,4	3,6	$\geq 3,68$
$f_{h,sp} = [h/(2 \cdot h_{ef})]^{2/3}$	1	1,07	1,13	1,19	1,25	1,31	1,37	1,42	1,48	1,5

Influence of reinforcement

Anchor size	M6x40	M8x40	M10x50	M10x60	M12x60
$f_{re,N} = 0,5 + h_{ef}/200mm \leq 1$	0,7 ^{a)}	0,7 ^{a)}	0,75 ^{a)}	0,8 ^{a)}	0,8 ^{a)}

- This factor applies only for dense reinforcement. If in the area of anchorage there is reinforcement with a spacing ≥ 150 mm (any diameter) or with a diameter ≤ 10 mm and a spacing ≥ 100 mm, then a factor $f_{re,N} = 1$ may be applied.

Shear loading

The design shear resistance is the lower value of

- Steel resistance: $V_{Rd,s}$
- Concrete pryout resistance: $V_{Rd,cp} = k \cdot N_{Rd,c}$
- Concrete edge resistance: $V_{Rd,c} = V_{Rd,c}^0 \cdot f_B \cdot f_h \cdot f_4 \cdot f_{hef} \cdot f_c$

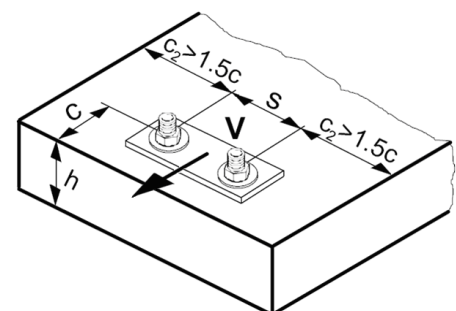

Basic design shear resistance

Design steel resistance $V_{Rd,s}$

Anchor size		M6x40	M8x40	M10x50	M10x60	M12x60
$V_{Rd,s}$	HSC-I [kN]	6,4	9,8	12,2	12,2	14,6
	HSC-IR [kN]	4,5	6,9	8,5	8,5	10,3

Design concrete pryout resistance $V_{Rd,cp} = k \cdot N_{Rd,c}^a$

Anchor size	M6x40	M8x40	M10x50	M10x60	M12x60
k	2,0				

a) $N_{Rd,c}$: Design concrete cone resistance

Design concrete edge resistance $V_{Rd,c}^a = V_{Rd,c}^0 \cdot f_B \cdot f_\beta \cdot f_h \cdot f_4 \cdot f_{hef} \cdot f_c$

Anchor size	Non-cracked concrete					Cracked concrete				
	M6x40	M8x40	M10x50	M10x60	M12x60	M6x40	M8x40	M10x50	M10x60	M12x60
$V_{Rd,c}^0$ [kN]	14,9	18,5	22,6	22,7	27,0	10,5	13,1	16,0	16,1	19,1

- For anchor groups only the anchors close to the edge must be considered.

Influencing factors

Influence of concrete strength

Concrete strength designation (ENV 206)	C 20/25	C 25/30	C 30/37	C 35/45	C 40/50	C 45/55	C 50/60
$f_B = (f_{ck,cube}/25N/mm^2)^{1/2}$ a)	1	1,1	1,22	1,34	1,41	1,48	1,55

- $f_{ck,cube}$ = concrete compressive strength, measured on cubes with 150 mm side length

Influence of angle between load applied and the direction perpendicular to the free edge

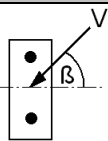
Angle β	0°	10°	20°	30°	40°	50°	60°	70°	80°	≥ 90°
$f_\beta = \frac{1}{\sqrt{(\cos \alpha_V)^2 + \left(\frac{\sin \alpha_V}{2,5}\right)^2}}$ 	1	1,01	1,05	1,13	1,24	1,40	1,64	1,97	2,32	2,50

Influence of base material thickness

h/c	0,15	0,3	0,45	0,6	0,75	0,9	1,05	1,2	1,35	≥ 1,5
$f_h = \{h/(1,5 \cdot c)\}^{1/2} \leq 1$	0,32	0,45	0,55	0,63	0,71	0,77	0,84	0,89	0,95	1,00

Influence of anchor spacing and edge distance ^{a)} for concrete edge resistance: f_4
 $f_4 = (c/h_{ef})^{1,5} \cdot (1 + s / [3 \cdot c]) \cdot 0,5$

c/h _{ef}	Single anchor	Group of two anchors s/h _{ef}														
		0,75	1,50	2,25	3,00	3,75	4,50	5,25	6,00	6,75	7,50	8,25	9,00	9,75	10,50	11,25
0,50	0,35	0,27	0,35	0,35	0,35	0,35	0,35	0,35	0,35	0,35	0,35	0,35	0,35	0,35	0,35	0,35
0,75	0,65	0,43	0,54	0,65	0,65	0,65	0,65	0,65	0,65	0,65	0,65	0,65	0,65	0,65	0,65	0,65
1,00	1,00	0,63	0,75	0,88	1,00	1,00	1,00	1,00	1,00	1,00	1,00	1,00	1,00	1,00	1,00	1,00
1,25	1,40	0,84	0,98	1,12	1,26	1,40	1,40	1,40	1,40	1,40	1,40	1,40	1,40	1,40	1,40	1,40
1,50	1,84	1,07	1,22	1,38	1,53	1,68	1,84	1,84	1,84	1,84	1,84	1,84	1,84	1,84	1,84	1,84
1,75	2,32	1,32	1,49	1,65	1,82	1,98	2,15	2,32	2,32	2,32	2,32	2,32	2,32	2,32	2,32	2,32
2,00	2,83	1,59	1,77	1,94	2,12	2,30	2,47	2,65	2,83	2,83	2,83	2,83	2,83	2,83	2,83	2,83
2,25	3,38	1,88	2,06	2,25	2,44	2,63	2,81	3,00	3,19	3,38	3,38	3,38	3,38	3,38	3,38	3,38
2,50	3,95	2,17	2,37	2,57	2,77	2,96	3,16	3,36	3,56	3,76	3,95	3,95	3,95	3,95	3,95	3,95
2,75	4,56	2,49	2,69	2,90	3,11	3,32	3,52	3,73	3,94	4,15	4,35	4,56	4,56	4,56	4,56	4,56
3,00	5,20	2,81	3,03	3,25	3,46	3,68	3,90	4,11	4,33	4,55	4,76	4,98	5,20	5,20	5,20	5,20
3,25	5,86	3,15	3,38	3,61	3,83	4,06	4,28	4,51	4,73	4,96	5,18	5,41	5,63	5,86	5,86	5,86
3,50	6,55	3,51	3,74	3,98	4,21	4,44	4,68	4,91	5,14	5,38	5,61	5,85	6,08	6,31	6,55	6,55
3,75	7,26	3,87	4,12	4,36	4,60	4,84	5,08	5,33	5,57	5,81	6,05	6,29	6,54	6,78	7,02	7,26
4,00	8,00	4,25	4,50	4,75	5,00	5,25	5,50	5,75	6,00	6,25	6,50	6,75	7,00	7,25	7,50	7,75
4,25	8,76	4,64	4,90	5,15	5,41	5,67	5,93	6,18	6,44	6,70	6,96	7,22	7,47	7,73	7,99	8,25
4,50	9,55	5,04	5,30	5,57	5,83	6,10	6,36	6,63	6,89	7,16	7,42	7,69	7,95	8,22	8,49	8,75
4,75	10,35	5,45	5,72	5,99	6,27	6,54	6,81	7,08	7,36	7,63	7,90	8,17	8,45	8,72	8,99	9,26
5,00	11,18	5,87	6,15	6,43	6,71	6,99	7,27	7,55	7,83	8,11	8,39	8,66	8,94	9,22	9,50	9,78
5,25	12,03	6,30	6,59	6,87	7,16	7,45	7,73	8,02	8,31	8,59	8,88	9,17	9,45	9,74	10,02	10,31
5,50	12,90	6,74	7,04	7,33	7,62	7,92	8,21	8,50	8,79	9,09	9,38	9,67	9,97	10,26	10,55	10,85

- The anchor spacing and the edge distance shall not be smaller than the minimum anchor spacing s_{min} and the minimum edge distance c_{min} .

Influence of embedment depth

Anchor size	M6x40	M8x40	M10x50	M10x60	M12x60
$f_{hef} = 0,05 \cdot (h_{ef} / d)^{1,68}$	0,29	0,23	0,28	0,38	0,32

Influence of edge distance ^{a)}

c/d	4	6	8	10	15	20	30	40
$f_c = (d / c)^{0,19}$	0,77	0,71	0,67	0,65	0,60	0,57	0,52	0,50

a) The edge distance shall not be smaller than the minimum edge distance c_{min} .

Combined tension and shear loading

For combined tension and shear loading see section "Anchor Design".

Precalculated values

Design resistance calculated according ETAG 001, Annex C and data given in ETA-02/0027, issue 2012-09-20.
 All data applies to concrete C 20/25 – $f_{ck,cube} = 25 \text{ N/mm}^2$.

Recommended loads can be calculated by dividing the design resistance by an overall partial safety factor for action $\gamma = 1,4$. The partial safety factors for action depend on the type of loading and shall be taken from national regulations.

Design resistance

Single anchor, no edge effects

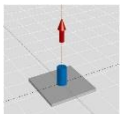
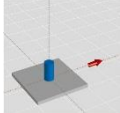
Anchor size		Non-cracked concrete					Cracked concrete					
		M6x 40	M8x 40	M10x 50	M10x 60	M12x 60	M6x 40	M8x 40	M10x 50	M10x 60	M12x 60	
Min. base material thickness h_{min} [mm]		100	100	110	130	130	100	100	110	130	130	
	Tensile N_{Rd}											
	HSC-I	[kN]	8,5	8,5	11,9	15,6	15,6	6,1	6,1	8,5	11,2	11,2
	HSC-IR	[kN]	7,5	8,5	11,9	14,2	15,6	6,1	6,1	8,5	11,2	11,2
	Shear V_{Rd}, without lever arm											
	HSC-I	[kN]	6,4	9,8	12,2	12,2	14,6	6,4	9,8	12,2	12,2	14,6
	HSC-IR	[kN]	4,5	6,9	8,5	8,5	10,3	4,5	6,9	8,5	8,5	10,3

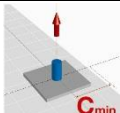
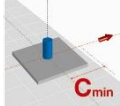

Single anchor, min. edge distance ($c = c_{min}$)

Anchor size		Non-cracked concrete					Cracked concrete					
		M6x 40	M8x 40	M10x 50	M10x 60	M12x 60	M6x 40	M8x 40	M10x 50	M10x 60	M12x 60	
Min. base material thickness h_{min} [mm]		100	100	110	130	130	100	100	110	130	130	
Min. edge distance c_{min} [mm]		40	40	50	60	60	40	40	50	60	60	
	Tensile N_{Rd}											
	HSC-I	[kN]	6,1	6,4	4,2	11,7	11,7	4,6	4,6	6,4	8,4	8,4
	HSC-IR	[kN]										
	Shear V_{Rd}, without lever arm											
	HSC-I	[kN]	3,6	3,6	5,2	6,8	7,0	2,5	2,6	3,7	4,9	4,9
	HSC-IR	[kN]										

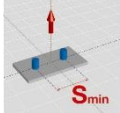
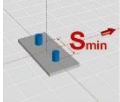
Double anchor, no edge effects, min. spacing ($s = s_{min}$), (load values are valid for one anchor)

Anchor size		Non-cracked concrete					Cracked concrete					
		M6x 40	M8x 40	M10x 50	M10x 60	M12x 60	M6x 40	M8x 40	M10x 50	M10x 60	M12x 60	
Min. base material thickness h_{min} [mm]		100	100	110	130	130	100	100	110	130	130	
Min. spacing s_{min} [mm]		40	40	50	60	60	40	40	50	60	60	
	Tensile N_{Rd}											
	HSC-I	[kN]	5,6	5,7	7,7	10,4	10,4	4,0	4,0	5,7	7,4	7,4
	HSC-IR	[kN]										
	Shear V_{Rd}, without lever arm											
	HSC-I	[kN]	6,4	9,8	12,2	12,2	14,6	6,4	8,1	11,3	12,2	14,6
	HSC-IR	[kN]	4,5	6,9	8,5	8,5	10,3	4,5	6,9	8,5	8,5	10,3

HST Stud anchor

	Anchor version	Benefits
	HST Carbon steel	- suitable for non-cracked and cracked concrete C 20/25 to C 50/60 - highly reliable and safe anchor for structural seismic design with ETA C1/C2 approval - quick and simple setting operation - safety wedge for certain follow up expansion
	HST-R Stainless steel	
	HST-HCR High corrosion resistance steel	



Concrete



Tensile zone



Seismic
ETA-C1/C2



Shock



Fire
resistance

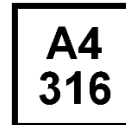

Corrosion
resistance



High corrosion
resistance



European
Technical
Approval



CE
conformity



PROFIS
Anchor design
software

Approvals / certificates

Description	Authority / Laboratory	No. / date of issue
European technical approval ^{a)}	DIBt, Berlin	ETA-98/0001 / 2013-05-08
Shockproof fastenings in civil defence installations	Federal Office for Civil Protection, Bern	BZS D 08-602 / 2008-12-15
Fire test report	DIBt, Berlin	ETA-98/0001 / 2013-05-08
Fire test report ZTV-Tunnel	IBMB, Braunschweig	UB 3332/0881-2 / 2003-07-02
Assessment report (fire)	warringtonfire	WF 327804/A / 2013-07-10

a) All data given in this section according ETA-98/0001, issue 2013-05-08.

Basic loading data (for a single anchor)

All data in this section applies to

- Correct setting (See setting instruction)
- No edge distance and spacing influence
- Concrete as specified in the table
- Steel failure
- Minimum base material thickness
- Concrete C 20/25, $f_{ck,cube} = 25 \text{ N/mm}^2$

For details see Simplified design method

Mean ultimate resistance

Anchor size	Non-cracked concrete						Cracked concrete					
	M8	M10	M12	M16	M20	M24	M8	M10	M12	M16	M20	M24
Tensile $N_{Ru,m}$												
HST [kN]	16,6	22,3	35,2	48,7	76,0	86,1	10,3	11,6	21,9	31,1	44,9	60,2
HST-R [kN]	18,1	26,7	35,1	49,8	77,4	79,1	12,7	18,4	20,1	36,0	55,1	70,5
HST-HCR [kN]	15,2	22,7	32,4	45,5	-	-	13,8	16,2	21,5	32,4	-	-
Shear $V_{Ru,m}$												
HST [kN]	17,6	27,8	40,5	67,8	102,9	112,3	17,6	27,8	40,5	67,8	102,9	112,3
HST-R [kN]	15,8	24,4	35,4	61,2	95,6	137,7	15,8	24,4	35,4	61,2	95,6	137,7
HST-HCR [kN]	17,6	27,8	40,5	75,4	-	-	17,6	27,8	40,5	75,4	-	-

Characteristic resistance

Anchor size	Non-cracked concrete						Cracked concrete					
	M8	M10	M12	M16	M20	M24	M8	M10	M12	M16	M20	M24
Tensile N_{Rk}												
HST [kN]	9,0	16,0	20,0	35,0	50,0	60,0	5,0	9,0	12,0	20,0	30,0	40,0
HST-R [kN]	9,0	16,0	20,0	35,0	50,0	60,0	5,0	9,0	12,0	25,0	30,0	40,0
HST-HCR [kN]	9,0	16,0	20,0	35,0	-	-	5,0	9,0	12,0	25,0	-	-
Shear V_{Rk}												
HST [kN]	14,0	23,5	35,0	55,0	84,0	94,0	14,0	23,5	35,0	55,0	84,0	94,0
HST-R [kN]	13,0	20,0	30,0	50,0	80,0	115,0	13,0	20,0	30,0	50,0	80,0	115,0
HST-HCR [kN]	13,0	20,0	30,0	55,0	-	-	13,0	20,0	30,0	53,5	-	-

Design resistance

Anchor size	Non-cracked concrete						Cracked concrete					
	M8	M10	M12	M16	M20	M24	M8	M10	M12	M16	M20	M24
Tensile N_{Rd}												
HST [kN]	5,0	10,7	13,3	23,3	33,3	40,0	2,8	6,0	8,0	13,3	20,0	26,7
HST-R [kN]	6,0	10,7	13,3	23,3	33,3	40,0	3,3	6,0	8,0	16,7	20,0	26,7
HST-HCR [kN]	6,0	10,7	13,3	23,3	-	-	3,3	6,0	8,0	16,7	-	-
Shear V_{Rd}												
HST [kN]	11,2	18,8	28,0	44,0	67,2	62,7	11,2	18,8	28,0	44,0	60,9	62,7
HST-R [kN]	10,4	16,0	24,0	38,5	55,6	79,9	10,4	16,0	24,0	35,6	55,6	79,9
HST-HCR [kN]	10,4	16,0	24,0	44,0	-	-	10,4	16,0	24,0	35,6	-	-

Recommended loads

Anchor size	Non-cracked concrete						Cracked concrete					
	M8	M10	M12	M16	M20	M24	M8	M10	M12	M16	M20	M24
Tensile $N_{rec}^{a)}$												
HST [kN]	3,6	7,6	9,5	16,7	23,8	28,6	2,0	4,3	5,7	9,5	14,3	19,0
HST-R [kN]	4,3	7,6	9,5	16,7	23,8	28,6	2,4	4,3	5,7	11,9	14,3	19,0
HST-HCR [kN]	4,3	7,6	9,5	16,7	-	-	2,4	4,3	5,7	11,9	-	-
Shear $V_{rec}^{a)}$												
HST [kN]	8,0	13,4	20,0	31,4	48,0	44,8	8,0	13,4	20,0	31,4	43,5	44,8
HST-R [kN]	7,4	11,4	17,1	27,5	39,7	57,0	7,4	11,4	17,1	25,5	39,7	57,0
HST-HCR [kN]	7,4	11,4	17,1	31,4	-	-	7,4	11,4	17,1	25,5	-	-

a) With overall partial safety factor for action $\gamma = 1,4$. The partial safety factors for action depend on the type of loading and shall be taken from national regulations.

Materials

Mechanical properties of HST, HST-R, HST-HCR

Anchor size		M8	M10	M12	M16	M20	M24
Nominal tensile strength f_{uk}	HST [N/mm ²]	800	800	800	720	700	530
	HST-R [N/mm ²]	720	700	700	650	650	650
	HST-HCR [N/mm ²]	800	800	800	800	-	-
Yield strength f_{yk}	HST [N/mm ²]	640	640	640	580	560	451
	HST-R [N/mm ²]	575	560	560	500	450	450
	HST-HCR [N/mm ²]	640	640	640	640	-	-
Stressed cross-section A_s	[mm ²]	36,6	58,0	84,3	157	245	353
Moment of resistance W	[mm ³]	31,2	62,3	109,2	277,5	540,9	935,5
Char. bending resistance $M_{Rk,s}^0$	HST [Nm]	30	60	105	240	454	595
	HST-R [Nm]	27	53	92	216	422	730
	HST-HCR [Nm]	30	60	105	266	-	-

Material quality

Part	Material	
Bolt	HST	Carbon steel, galvanised to min. 5 μ m
	HST-R	Stainless steel
	HST-HCR	High corrosion resistant steel

Anchor dimensions

Anchor size		M8	M10	M12	M16	M20	M24
Minimum thickness of fixture	$t_{fix,min}$ [mm]	2	2	2	2	2	2
Maximum thickness of fixture	$t_{fix,max}$ [mm]	195	200	200	235	305	330
Shaft diameter at the cone	d_R [mm]	5,5	7,2	8,5	11,6	14,6	17,4
Minimum length of the anchor	$l_{1,min}$ [mm]	75	90	115	140	170	200
Maximum length of the anchor	$l_{1,max}$ [mm]	260	280	295	350	450	500
Length of expansion sleeve	l_2 [mm]	14,8	18,2	22,7	24,3	28,3	36

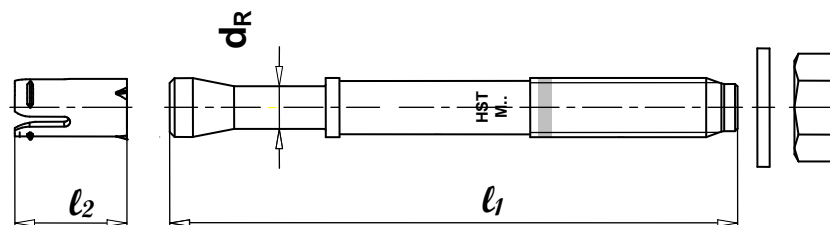

Setting

Installation equipment

Anchor size	M8	M10	M12	M16	M20	M24
Rotary hammer	TE2 – TE16				TE40 – TE70	
Other tools	hammer, torque wrench, blow out pump					

Setting instruction

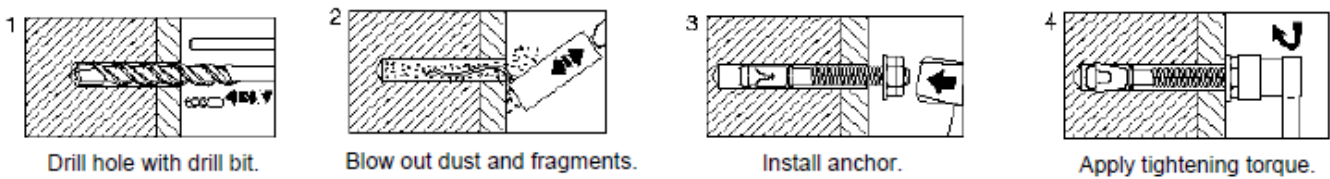

For detailed information on installation see instruction for use given with the package of the product.

For technical data for anchors in diamond drilled holes please contact the Hilti Technical advisory service.

Setting details: depth of drill hole h_1 and effective anchorage depth h_{ef}

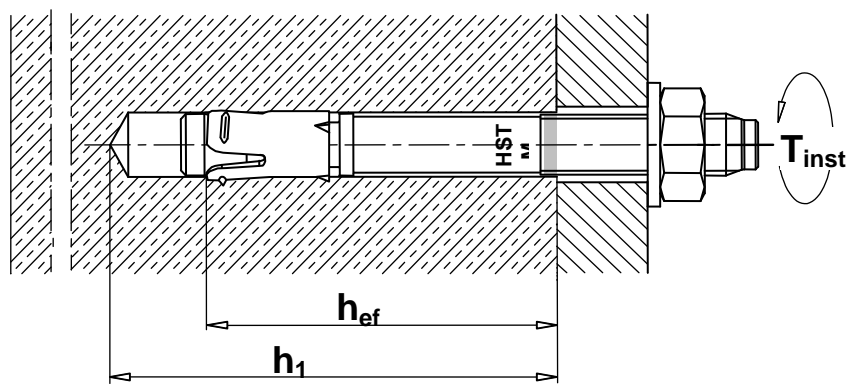

Setting details HST, HST-R, HST-HCR

		M8	M10	M12	M16	M20	M24
Nominal diameter of drill bit	d_o [mm]	8	10	12	16	20	24
Cutting diameter of drill bit	$d_{cut} \leq$ [mm]	8,45	10,45	12,5	16,5	20,55	24,55
Depth of drill hole	$h_1 \geq$ [mm]	65	80	95	115	140	170
Diameter of clearance hole in the fixture	$d_f \leq$ [mm]	9	12	14	18	22	26
Effective anchorage depth	h_{ef} [mm]	47	60	70	82	101	125
Torque moment	T_{inst} [Nm]	20	45	60	110	240	300
Width across	SW [mm]	13	17	19	24	30	36

Setting parameters

Anchor size			M8	M10	M12	M16	M20	M24	
Minimum base material thickness		h_{min}	[mm]	100	120	140	160	200	250
Minimum spacing in non-cracked concrete	HST	s_{min}	[mm]	60	55	60	70	100	125
		for $c \geq$	[mm]	50	80	85	110	225	255
	HST-R	s_{min}	[mm]	60	55	60	70	100	125
		for $c \geq$	[mm]	60	70	80	110	195	205
	HST-HCR	s_{min}	[mm]	60	55	60	70	-	-
		for $c \geq$	[mm]	50	70	80	110	-	-
Minimum spacing in cracked concrete	HST	s_{min}	[mm]	40	55	60	70	100	125
		for $c \geq$	[mm]	50	70	75	100	160	180
	HST-R	s_{min}	[mm]	40	55	60	70	100	125
		for $c \geq$	[mm]	50	65	75	100	130	130
	HST-HCR	s_{min}	[mm]	40	55	60	70	-	-
		for $c \geq$	[mm]	50	70	75	100	-	-
Minimum edge distance in non-cracked concrete	HST	c_{min}	[mm]	50	55	55	85	140	170
		for $s \geq$	[mm]	60	115	145	150	270	295
	HST-R	c_{min}	[mm]	60	50	55	70	140	150
		for $s \geq$	[mm]	60	115	145	160	210	235
	HST-HCR	c_{min}	[mm]	60	55	55	70	-	-
		for $s \geq$	[mm]	60	115	145	160	-	-
Minimum edge distance in cracked concrete	HST	c_{min}	[mm]	45	55	55	70	100	125
		for $s \geq$	[mm]	50	90	120	150	225	240
	HST-R HST-HCR	c_{min}	[mm]	45	50	55	60	100	125
		for $s \geq$	[mm]	50	90	110	160	160	140
Critical spacing for splitting failure and concrete cone failure		$s_{cr,sp}$ $s_{cr,N}$	[mm]	141	180	210	246	303	375
Critical edge distance for splitting failure and concrete cone failure		$c_{cr,sp}$ $c_{cr,N}$	[mm]	71	90	105	123	152	188

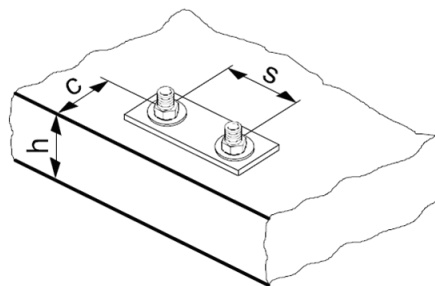

For spacing (edge distance) smaller than critical spacing (critical edge distance) the design loads have to be reduced.

Simplified design method

Simplified version of the design method according ETAG 001, Annex C. Design resistance according data given in ETA-98/0001, issue 2013-05-08.

- Influence of concrete strength
- Influence of edge distance
- Influence of spacing
- Valid for a group of two anchors. (The method may also be applied for anchor groups with more than two anchors or more than one edge. The influencing factors must then be considered for each edge distance and spacing. The calculated design loads are then on the save side: They will be lower than the exact values according ETAG 001, Annex C. To avoid this, it is recommended to use the anchor design software PROFIS anchor)

The design method is based on the following simplification:

- No different loads are acting on individual anchors (no eccentricity)

The values are valid for one anchor.

For more complex fastening applications please use the anchor design software PROFIS Anchor.

Tension loading

The design tensile resistance is the lower value of

- Steel resistance: $N_{Rd,s}$
- Concrete pull-out resistance: $N_{Rd,p} = N_{Rd,p}^0 \cdot f_B$
- Concrete cone resistance: $N_{Rd,c} = N_{Rd,c}^0 \cdot f_B \cdot f_{1,N} \cdot f_{2,N} \cdot f_{3,N} \cdot f_{re,N}$
- Concrete splitting resistance (only non-cracked concrete):
 $N_{Rd,sp} = N_{Rd,c}^0 \cdot f_B \cdot f_{1,sp} \cdot f_{2,sp} \cdot f_{3,sp} \cdot f_{h,sp} \cdot f_{re,N}$

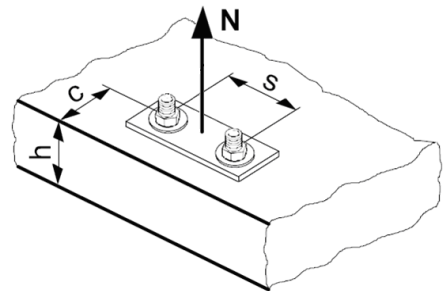

Basic design tensile resistance

Design steel resistance $N_{Rd,s}$

Anchor size		M8	M10	M12	M16	M20	M24
$N_{Rd,s}$	HST [kN]	12,7	21,3	30,0	50,7	78,0	90,1
	HST-R [kN]	11,3	18,7	26,7	44,2	63,0	90,2
	HST-HCR [kN]	12,9	21,5	30,5	56,3	-	-

Design pull-out resistance $N_{Rd,p} = N_{Rd,p}^0 \cdot f_B$

Anchor size		Non-cracked concrete						Cracked concrete					
		M8	M10	M12	M16	M20	M24	M8	M10	M12	M16	M20	M24
$N_{Rd,p}^0$	HST [kN]	5,0	10,7	13,3	23,3	33,3	40,0	2,8	6,0	8,0	13,3	20,0	26,7
	HST-R [kN]	6,0	10,7	13,3	23,3	33,3	40,0	3,3	6,0	8,0	16,7	20,0	26,7
	HST-HCR [kN]	6,0	10,7	13,3	23,3	-	-	3,3	6,0	8,0	16,7	-	-

Design concrete cone resistance $N_{Rd,c} = N_{Rd,c}^0 \cdot f_B \cdot f_{1,N} \cdot f_{2,N} \cdot f_{3,N} \cdot f_{re,N}$

Design splitting resistance ^{a)} $N_{Rd,sp} = N_{Rd,c}^0 \cdot f_B \cdot f_{1,sp} \cdot f_{2,sp} \cdot f_{3,sp} \cdot f_{h,sp} \cdot f_{re,N}$

Anchor size		Non-cracked concrete						Cracked concrete					
		M8	M10	M12	M16	M20	M24	M8	M10	M12	M16	M20	M24
$N_{Rd,c}^0$	HST [kN]	9,0	15,6	19,7	24,9	34,1	47	6,4	11,2	14,1	17,8	24,4	33,5
	HST-R [kN]	10,8	15,6	19,7	24,9	34,1	47	7,7	11,2	14,1	17,8	24,4	33,5
	HST-HCR [kN]	10,8	15,6	19,7	24,9	-	-	7,7	11,2	14,1	17,8	-	-

a) Splitting resistance must only be considered for non-cracked concrete

Influencing factors

Influence of concrete strength

Concrete strength designation (ENV 206)	C 20/25	C 25/30	C 30/37	C 35/45	C 40/50	C 45/55	C 50/60
$f_B = (f_{ck,cube}/25N/mm^2)^{1/2}$ ^{a)}	1	1,1	1,22	1,34	1,41	1,48	1,55

a) $f_{ck,cube}$ = concrete compressive strength, measured on cubes with 150 mm side length

Influence of edge distance ^{a)}

$c/c_{cr,N}$	0,1	0,2	0,3	0,4	0,5	0,6	0,7	0,8	0,9	1
$c/c_{cr,sp}$										
$f_{1,N} = 0,7 + 0,3 \cdot c/c_{cr,N} \leq 1$	0,73	0,76	0,79	0,82	0,85	0,88	0,91	0,94	0,97	1
$f_{1,sp} = 0,7 + 0,3 \cdot c/c_{cr,sp} \leq 1$										
$f_{2,N} = 0,5 \cdot (1 + c/c_{cr,N}) \leq 1$	0,55	0,60	0,65	0,70	0,75	0,80	0,85	0,90	0,95	1
$f_{2,sp} = 0,5 \cdot (1 + c/c_{cr,sp}) \leq 1$										

a) The edge distance shall not be smaller than the minimum edge distance c_{min} given in the table with the setting details. These influencing factors must be considered for every edge distance.

Influence of anchor spacing ^{a)}

$s/s_{cr,N}$	0,1	0,2	0,3	0,4	0,5	0,6	0,7	0,8	0,9	1
$s/s_{cr,sp}$										
$f_{3,N} = 0,5 \cdot (1 + s/s_{cr,N}) \leq 1$	0,55	0,60	0,65	0,70	0,75	0,80	0,85	0,90	0,95	1
$f_{3,sp} = 0,5 \cdot (1 + s/s_{cr,sp}) \leq 1$										

a) The anchor spacing shall not be smaller than the minimum anchor spacing s_{min} given in the table with the setting details. This influencing factor must be considered for every anchor spacing.

Influence of base material thickness

h/h_{ef}	2,0	2,2	2,4	2,6	2,8	3,0	3,2	3,4	3,6	$\geq 3,68$
$f_{h,sp} = [h/(2 \cdot h_{ef})]^{2/3}$	1	1,07	1,13	1,19	1,25	1,31	1,37	1,42	1,48	1,5

Influence of reinforcement

Anchor size	M8	M10	M12	M16	M20	M24
$f_{re,N} = 0,5 + h_{ef}/200mm \leq 1$	0,74 ^{a)}	0,8 ^{a)}	0,85 ^{a)}	0,91 ^{a)}	1	1

a) This factor applies only for dense reinforcement. If in the area of anchorage there is reinforcement with a spacing ≥ 150 mm (any diameter) or with a diameter ≤ 10 mm and a spacing ≥ 100 mm, then a factor $f_{re,N} = 1$ may be applied.

Shear loading

The design shear resistance is the lower value of

- Steel resistance: $V_{Rd,s}$
- Concrete pryout resistance: $V_{Rd,cp} = k \cdot N_{Rd,c}$
- Concrete edge resistance: $V_{Rd,c} = V_{Rd,c}^0 \cdot f_B \cdot f_{\beta} \cdot f_h \cdot f_4 \cdot f_{hef} \cdot f_c$

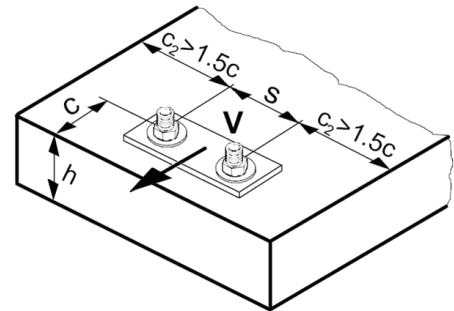

Basic design shear resistance

Design steel resistance $V_{Rd,s}$

Anchor size		M8	M10	M12	M16	M20	M24
$V_{Rd,s}$	HST [kN]	11,2	18,8	28,0	44,0	67,2	62,7
	HST-R [kN]	10,4	16,0	24,0	38,5	55,6	79,9
	HST-HCR [kN]	10,4	16,0	24,0	44,0	-	-

Design concrete pryout resistance $V_{Rd,cp} = k \cdot N_{Rd,c}^a$

Anchor size	M8	M10	M12	M16	M20	M24
k	2	2	2,2	2,5	2,5	2,5

a) $N_{Rd,c}$: Design concrete cone resistance

Design concrete edge resistance $V_{Rd,c}^a = V_{Rd,c}^0 \cdot f_B \cdot f_{\beta} \cdot f_h \cdot f_4 \cdot f_{hef} \cdot f_c$

Anchor size	Non-cracked concrete						Cracked concrete					
	M8	M10	M12	M16	M20	M24	M8	M10	M12	M16	M20	M24
$V_{Rd,c}^0$ [kN]	5,9	8,6	11,7	18,9	27,3	37,1	4,2	6,1	8,3	13,4	19,3	26,3

a) For anchor groups only the anchors close to the edge must be considered.

Influencing factors

Influence of concrete strength

Concrete strength designation (ENV 206)	C 20/25	C 25/30	C 30/37	C 35/45	C 40/50	C 45/55	C 50/60
$f_B = (f_{ck,cube}/25N/mm^2)^{1/2}$ a)	1	1,1	1,22	1,34	1,41	1,48	1,55

a) $f_{ck,cube}$ = concrete compressive strength, measured on cubes with 150 mm side length

Influence of angle between load applied and the direction perpendicular to the free edge

Angle β	0°	10°	20°	30°	40°	50°	60°	70°	80°	≥ 90°
$f_{\beta} = \frac{1}{\sqrt{(\cos \alpha_V)^2 + \left(\frac{\sin \alpha_V}{2,5}\right)^2}}$	1	1,01	1,05	1,13	1,24	1,40	1,64	1,97	2,32	2,50

Influence of base material thickness

h/c	0,15	0,3	0,45	0,6	0,75	0,9	1,05	1,2	1,35	≥ 1,5
$f_h = \{h/(1,5 \cdot c)\}^{1/2} \leq 1$	0,32	0,45	0,55	0,63	0,71	0,77	0,84	0,89	0,95	1,00

Influence of anchor spacing and edge distance ^{a)} for concrete edge resistance: f_4

$$f_4 = (c/h_{ef})^{1,5} \cdot (1 + s / [3 \cdot c]) \cdot 0,5$$

c/h _{ef}	Single anchor	Group of two anchors s/h _{ef}														
		0,75	1,50	2,25	3,00	3,75	4,50	5,25	6,00	6,75	7,50	8,25	9,00	9,75	10,50	11,25
0,50	0,35	0,27	0,35	0,35	0,35	0,35	0,35	0,35	0,35	0,35	0,35	0,35	0,35	0,35	0,35	0,35
0,75	0,65	0,43	0,54	0,65	0,65	0,65	0,65	0,65	0,65	0,65	0,65	0,65	0,65	0,65	0,65	0,65
1,00	1,00	0,63	0,75	0,88	1,00	1,00	1,00	1,00	1,00	1,00	1,00	1,00	1,00	1,00	1,00	1,00
1,25	1,40	0,84	0,98	1,12	1,26	1,40	1,40	1,40	1,40	1,40	1,40	1,40	1,40	1,40	1,40	1,40
1,50	1,84	1,07	1,22	1,38	1,53	1,68	1,84	1,84	1,84	1,84	1,84	1,84	1,84	1,84	1,84	1,84
1,75	2,32	1,32	1,49	1,65	1,82	1,98	2,15	2,32	2,32	2,32	2,32	2,32	2,32	2,32	2,32	2,32
2,00	2,83	1,59	1,77	1,94	2,12	2,30	2,47	2,65	2,83	2,83	2,83	2,83	2,83	2,83	2,83	2,83
2,25	3,38	1,88	2,06	2,25	2,44	2,63	2,81	3,00	3,19	3,38	3,38	3,38	3,38	3,38	3,38	3,38
2,50	3,95	2,17	2,37	2,57	2,77	2,96	3,16	3,36	3,56	3,76	3,95	3,95	3,95	3,95	3,95	3,95
2,75	4,56	2,49	2,69	2,90	3,11	3,32	3,52	3,73	3,94	4,15	4,35	4,56	4,56	4,56	4,56	4,56
3,00	5,20	2,81	3,03	3,25	3,46	3,68	3,90	4,11	4,33	4,55	4,76	4,98	5,20	5,20	5,20	5,20
3,25	5,86	3,15	3,38	3,61	3,83	4,06	4,28	4,51	4,73	4,96	5,18	5,41	5,63	5,86	5,86	5,86
3,50	6,55	3,51	3,74	3,98	4,21	4,44	4,68	4,91	5,14	5,38	5,61	5,85	6,08	6,31	6,55	6,55
3,75	7,26	3,87	4,12	4,36	4,60	4,84	5,08	5,33	5,57	5,81	6,05	6,29	6,54	6,78	7,02	7,26
4,00	8,00	4,25	4,50	4,75	5,00	5,25	5,50	5,75	6,00	6,25	6,50	6,75	7,00	7,25	7,50	7,75
4,25	8,76	4,64	4,90	5,15	5,41	5,67	5,93	6,18	6,44	6,70	6,96	7,22	7,47	7,73	7,99	8,25
4,50	9,55	5,04	5,30	5,57	5,83	6,10	6,36	6,63	6,89	7,16	7,42	7,69	7,95	8,22	8,49	8,75
4,75	10,35	5,45	5,72	5,99	6,27	6,54	6,81	7,08	7,36	7,63	7,90	8,17	8,45	8,72	8,99	9,26
5,00	11,18	5,87	6,15	6,43	6,71	6,99	7,27	7,55	7,83	8,11	8,39	8,66	8,94	9,22	9,50	9,78
5,25	12,03	6,30	6,59	6,87	7,16	7,45	7,73	8,02	8,31	8,59	8,88	9,17	9,45	9,74	10,02	10,31
5,50	12,90	6,74	7,04	7,33	7,62	7,92	8,21	8,50	8,79	9,09	9,38	9,67	9,97	10,26	10,55	10,85

a) The anchor spacing and the edge distance shall not be smaller than the minimum anchor spacing s_{min} and the minimum edge distance c_{min} .

Influence of embedment depth

Anchor size	M8	M10	M12	M16	M20	M24
$f_{hef} = 0,05 \cdot (h_{ef} / d)^{1,68}$	0,98	1,01	0,97	0,78	0,76	0,80

Influence of edge distance ^{a)}

c/d	4	6	8	10	15	20	30	40
$f_c = (d / c)^{0,19}$	0,77	0,71	0,67	0,65	0,60	0,57	0,52	0,50

a) The edge distance shall not be smaller than the minimum edge distance c_{min} .

Combined tension and shear loading

For combined tension and shear loading see section "Anchor Design".

Precalculated values

Design resistance calculated according ETAG 001, Annex C and data given in ETA-98/0001, issue 2013-05-08.
All data applies to concrete C 20/25 – $f_{ck,cube} = 25$ N/mm².

Recommended loads can be calculated by dividing the design resistance by an overall partial safety factor for action $\gamma = 1,4$. The partial safety factors for action γ depend on the type of loading and shall be taken from national regulations.

Design resistance

Single anchor, no edge effects

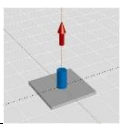
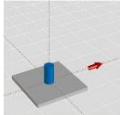
Anchor size		Non-cracked concrete						Cracked concrete						
		M8	M10	M12	M16	M20	M24	M8	M10	M12	M16	M20	M24	
Min. base material thickness h_{min} [mm]		100	120	140	160	200	250	100	120	140	160	200	250	
	Tensile N_{Rd}													
	HST	[kN]	5,0	10,7	13,3	23,3	33,3	40,0	2,8	6,0	8,0	13,3	20,0	26,7
	HST-R	[kN]	6,0	10,7	13,3	23,3	33,3	40,0	3,3	6,0	8,0	16,7	20,0	26,7
	HST-HCR	[kN]	6,0	10,7	13,3	23,3	-	-	3,3	6,0	8,0	16,7	-	-
	Shear V_{Rd}, without lever arm													
	HST	[kN]	11,2	18,8	28,0	44,0	67,2	62,7	11,2	18,8	28,0	44,0	60,9	62,7
	HST-R	[kN]	10,4	16,0	24,0	38,5	55,6	79,9	10,4	16,0	24,0	38,5	55,6	79,9
	HST-HCR	[kN]	10,4	16,0	24,0	44,0	-	-	10,4	16,0	24,0	44,0	-	-

Single anchor, min. edge distance ($c = c_{min}$)

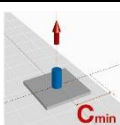
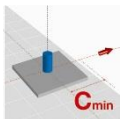
Anchor size		Non-cracked concrete						Cracked concrete						
		M8	M10	M12	M16	M20	M24	M8	M10	M12	M16	M20	M24	
Min. base material thickness h_{min} [mm]		100	120	140	160	200	250	100	120	140	160	200	250	
Min. edge distance c_{min}	HST	[mm]	50	55	55	85	140	170	45	55	55	70	100	125
	HST-R	[mm]	60	50	55	70	140	150	45	50	55	60	100	125
	HST-HCR	[mm]	60	55	55	70	-	-	45	50	55	60	-	-
	Tensile N_{Rd}													
	HST	[kN]	5,0	10,7	12,9	19,1	32,1	40,0	2,8	6,0	8,0	12,2	18,2	25,2
	HST-R	[kN]	6,0	10,5	12,9	17,0	32,1	39,7	3,3	6,0	8,0	11,2	18,2	25,2
	HST-HCR	[kN]	6,0	10,7	12,9	17,0	-	-	3,3	6,0	8,0	11,2	-	-
	Shear V_{Rd}, without lever arm													
	HST	[kN]	4,5	5,6	5,9	11,3	22,8	32,0	2,8	3,9	4,2	6,2	10,7	15,4
	HST-R	[kN]	5,8	4,9	5,9	8,8	22,8	27,5	2,8	3,5	4,2	5,1	10,7	15,4
	HST-HCR	[kN]	5,8	5,6	5,9	8,8	-	-	2,8	3,5	4,2	5,1	-	-

Double anchor, no edge effects, min. spacing ($s = s_{min}$), (load values are valid for one anchor)

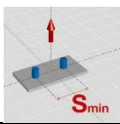
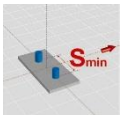
Anchor size		Non-cracked concrete						Cracked concrete						
		M8	M10	M12	M16	M20	M24	M8	M10	M12	M16	M20	M24	
Min. base material thickness h_{min} [mm]		100	120	140	160	200	250	100	120	140	160	200	250	
Min. spacing s_{min} [mm]		60	55	60	70	100	125	40	55	60	70	100	125	
	Tensile N_{Rd}													
	HST	[kN]	5,0	10,2	12,7	16,0	22,7	31,3	2,8	6,0	8,0	11,4	16,2	22,4
	HST-R	[kN]	6,0	10,2	12,7	16,0	22,7	31,3	3,3	6,0	8,0	11,4	16,2	22,4
	HST-HCR	[kN]	6,0	10,2	12,7	16,0	-	-	3,3	6,0	8,0	11,4	-	-
	Shear V_{Rd}, without lever arm													
	HST	[kN]	11,2	18,8	27,8	40,1	56,7	62,7	8,3	14,6	19,9	22,9	40,5	55,9
	HST-R	[kN]	10,4	16,0	24,0	38,5	55,6	78,4	9,9	14,6	19,9	28,6	40,5	55,9
	HST-HCR	[kN]	10,4	16,0	24,0	40,1	-	-	9,9	14,6	19,9	28,6	-	-

Seismic design C1 and C2

Basic loading data for concrete C20/25 – C50/60

All data in this section applies to:

- Seismic design according to TR045

The following technical data are based on: ETA-98/0001 issue 2013-05-08

Anchorage depth range

Anchor size	M8	M10	M12	M16	M20	M24
Nominal anchorage depth range h_{nom} [mm]	55	69	80	95	117	143

Tension resistance in case of seismic performance category C1

Anchor size		M10	M12	M16
Characteristic tension resistance to steel failure				
HST (steel galvanized)				
Characteristic resistance $N_{Rk,s,seis}$ [kN]		32	45	76
Partial safety factor $\gamma_{Ms,seis}$ [-]		1,5		
HST-R (stainless steel)				
Characteristic resistance $N_{Rk,s,seis}$ [kN]		28	40	69
Partial safety factor $\gamma_{Ms,seis}$ [-]		1,5		1,56
Pullout failure				
HST (steel galvanized) and HST-R (stainless steel)				
Characteristic resistance $N_{Rk,p,seis}$ [kN]		8,0	10,7	18,0
Partial safety factor $\gamma_{Mp,seis}$ [-]		1,5		
Concrete cone and splitting failure				
HST (steel galvanized) and HST-R (stainless steel)				
Partial safety factor $\gamma_{Mc,seis} = \gamma_{Msp,seis}$ [-]		1,5		

Displacement under tension load in case of seismic performance category C1 ¹⁾

Anchor size		M10	M12	M16
Displacement HST and HST-R $\delta_{N,seis}$ [mm]		1,1	0,8	1,0

1) Maximum displacement during cycling (seismic event).

Shear resistance in case of seismic performance category C1 ¹⁾

Anchor size		M10	M12	M16
Steel failure				
HST (steel galvanized)				
Characteristic resistance	$V_{Rk,s,seis}$ [kN]	16	27	41,3
Partial safety factor	$\gamma_{Ms,seis}$ [-]	1,25		
HST-R (stainless steel)				
Characteristic resistance	$V_{Rk,s,seis}$ [kN]	13,6	23,1	37,5
Partial safety factor	$\gamma_{Ms,seis}$ [-]	1,25		1,3
Concrete pryout and concrete edge failure				
HST (steel galvanized) and HST-R (stainless steel)				
Partial safety factor	$\gamma_{Mcp,seis} = \gamma_{Mc,seis}$ [-]	1,5		

1) Reduction factor $\alpha_{gap} = 1,0$ when using the Hilti Dynamic Set

Displacement under shear load for seismic loading, performance category C1 ¹⁾

Anchor size		M10	M12	M16
Displacement HST and HST-R	$\delta_{V,seis}$ [mm]	6,2	7,3	6,2

1) Maximum displacement during cycling (seismic event).

For seismic resistant fastening applications please use the anchor design software PROFIS Anchor.

Tension resistance in case of seismic performance category C2

Anchor size		M10	M12	M16
Characteristic tension resistance to steel failure				
HST (steel galvanized)				
Characteristic resistance	$N_{Rk,s,seis}$ [kN]	32	45	76
Partial safety factor	$\gamma_{Ms,seis}$ [-]	1,5		
HST-R (stainless steel)				
Characteristic resistance	$N_{Rk,s,seis}$ [kN]	28	40	69
Partial safety factor	$\gamma_{Ms,seis}$ [-]	1,5		1,56
Pullout failure				
HST (steel galvanized) and HST-R (stainless steel)				
Characteristic resistance	$N_{Rk,p,seis}$ [kN]	3,3	10,0	12,8
Partial safety factor	$\gamma_{Ms,seis}$ [-]	1,5		
Concrete cone and splitting failure				
HST (steel galvanized) and HST-R (stainless steel)				
Partial safety factor	$\gamma_{Mc,seis} = \gamma_{Msp,seis}$ [-]	1,5		

Displacement under tension load in case of seismic performance category C2

Anchor size		M10	M12	M16
HST and HST-R				
Displacement DLS	$\delta_{N,seis(DLS)}$ [mm]	1,4	6,7	4,0
Displacement ULS	$\delta_{N,seis(ULS)}$ [mm]	8,6	15,9	13,3

Shear resistance in case of seismic performance category C2 ¹⁾

Anchor size		M10	M12	M16
Steel failure				
HST (steel galvanized)				
Characteristic resistance	$V_{Rk,s,seis}$ [kN]	14,3	21	41,3
Partial safety factor	$\gamma_{Ms,seis}$ [-]	1,25		
HST-R (stainless steel)				
Characteristic resistance	$V_{Rk,s,seis}$ [kN]	12	18	37,5
Partial safety factor	$\gamma_{Ms,seis}$ [-]	1,25		1,3
Concrete pryout and concrete edge failure				
HST (steel galvanized) and HST-R (stainless steel)				
Partial safety factor	$\gamma_{Mcp,seis} = \gamma_{Mc,seis}$ [-]	1,5		

1) Reduction factor $\alpha_{gap} = 1,0$ when using the Hilti Dynamic Set

Displacement under shear load in case of seismic performance category C2

Anchor size		M10	M12	M16
HST and HST-R				
Displacement DLS	$\delta_{V,seis(DLS)}$ [mm]	4,2	5,3	5,7
Displacement ULS	$\delta_{V,seis(DLS)}$ [mm]	7,5	7,9	8,9

For seismic resistant fastening applications please use the anchor design software PROFIS Anchor.

HSA Stud anchor

	Anchor version	Benefits
	HSA Carbon steel with DIN 125 washe	<ul style="list-style-type: none"> - Fast & convenient setting behaviour - Reliable ETA approved torqueing using impact wrench with torque bar for torque control - Small edge and spacing distances - High loads - Three embedment depths for maximal design flexibility - M12, M16 and M20 ETA approved for diamond cored holes using DD 30-W and matching diamond core bit - Suitable for pre- and through fastening
	HSA-R Stainless steel A4 HSA-R2 Stainless steel A2 with DIN 125 washer	
	HSA-BW Carbon steel with DIN 9021 washer	

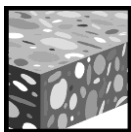

Concrete

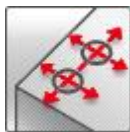

Small edge distance and spacing



Fire resistance

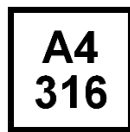

Corrosion resistance



Diamond drilled holes



European Technical Approval



CE conformity



PROFIS Anchor design software

Approvals / certificates

Description	Authority / Laboratory	No. / date of issue
European technical approval ^{a)}	DIBt, Berlin	ETA-11/0374 / 2012-07-19
Fire test report	IBMB, Braunschweig	3215/229/12 / 2012-08-09

a) All data given in this section according ETA-11/0374, issue 2012-07-19.

Basic loading data (for a single anchor)

All data in this section applies to

- Correct setting (See setting instruction)
- No edge distance and spacing influence
- Steel failure
- Minimum base material thickness
- Non-cracked Concrete C 20/25, $f_{ck,cube} = 25 \text{ N/mm}^2$

For details see Simplified design method

Mean ultimate resistance

Anchor size			M6			M8			M10		
Effective anchorage depth	h_{ef}	[mm]	30	40	60	30	40	70	40	50	80
Tensile $N_{R,u,m}$											
HSA, HSA-BW	[kN]		8,0	9,5	9,5	11,0	17,0	17,3	17,0	23,7	29,4
HSA-R2, HSA-R	[kN]		8,0	10,0	11,9	11,0	17,0	19,2	17,0	23,7	33,2
Shear $V_{R,u,m}$											
HSA, HSA-BW	[kN]		6,8	6,8	6,8	11,0	11,1	11,1	19,8	19,8	19,8
HSA-R2, HSA-R	[kN]		7,6	7,6	7,6	11,0	12,9	12,9	23,7	23,7	23,7

Anchor size			M12			M16			M20		
Effective anchorage depth	h_{ef}	[mm]	50	65	100	65	80	120	75	100	115
Tensile $N_{R,u,m}$											
HSA, HSA-BW	[kN]		23,7	35,1	43,5	35,1	48,0	66,4	43,5	67,0	82,7
HSA-R2, HSA-R	[kN]		23,7	35,1	46,5	35,1	48,0	66,4	43,5	67,0	82,7
Shear $V_{R,u,m}$											
HSA, HSA-BW	[kN]		31,0	31,0	31,0	53,6	53,6	53,6	87,1	90,1	90,1
HSA-R2, HSA-R	[kN]		30,8	30,8	30,8	59,3	59,3	59,3	87,1	96,5	96,5

Characteristic resistance

Anchor size			M6			M8			M10		
Effective anchorage depth	h_{ef}	[mm]	30	40	60	30	40	70	40	50	80
Tensile N_{Rk}											
HSA, HSA-BW	[kN]		6,0	7,5	9,0	8,3	12,8	16,0	12,8	17,9	25,0
HSA-R2, HSA-R	[kN]		6,0	7,5	9,0	8,3	12,8	16,0	12,8	17,9	25,0
Shear V_{Rk}											
HSA, HSA-BW	[kN]		6,5	6,5	6,5	8,3	10,6	10,6	18,9	18,9	18,9
HSA-R2, HSA-R	[kN]		7,2	7,2	7,2	8,3	12,3	12,3	22,6	22,6	22,6

Anchor size			M12			M16			M20		
Effective anchorage depth	h_{ef}	[mm]	50	65	100	65	80	120	75	100	115
Tensile N_{Rk}											
HSA, HSA-BW	[kN]		17,9	26,5	35,0	26,5	36,1	50,0	32,8	50,5	62,3
HSA-R2, HSA-R	[kN]		17,9	26,5	35,0	26,5	36,1	50,0	32,8	50,5	62,3
Shear V_{Rk}											
HSA, HSA-BW	[kN]		29,5	29,5	29,5	51,0	51,0	51,0	65,6	85,8	85,8
HSA-R2, HSA-R	[kN]		29,3	29,3	29,3	56,5	56,5	56,5	65,6	91,9	91,9

Design resistance

Anchor size			M6			M8			M10		
Effective anchorage depth	h_{ef}	[mm]	30	40	60	30	40	70	40	50	80
Tensile N_{Rd}											
HSA, HSA-BW	[kN]		4,0	5,0	6,0	5,5	8,5	10,7	8,5	11,9	16,7
HSA-R2, HSA-R	[kN]		4,0	5,0	6,0	5,5	8,5	10,7	8,5	11,9	16,7
Shear V_{Rd}											
HSA, HSA-BW	[kN]		5,2	5,2	5,2	5,5	8,5	8,5	15,1	15,1	15,1
HSA-R2, HSA-R	[kN]		5,5	5,8	5,8	5,5	9,8	9,8	18,1	18,1	18,1

Anchor size			M12			M16			M20		
Effective anchorage depth	h_{ef}	[mm]	50	65	100	65	80	120	75	100	115
Tensile N_{Rd}											
HSA, HSA-BW	[kN]		11,9	17,6	23,3	17,6	24,1	33,3	21,9	33,7	41,5
HSA-R2, HSA-R	[kN]		11,9	17,6	23,3	17,6	24,1	33,3	21,9	33,7	41,5
Shear V_{Rd}											
HSA, HSA-BW	[kN]		23,6	23,6	23,6	40,8	40,8	40,8	43,7	68,6	68,6
HSA-R2, HSA-R	[kN]		23,4	23,4	23,4	45,2	45,2	45,2	43,7	73,5	73,5

Recommended loads

Anchor size			M6			M8			M10		
Effective anchorage depth	h_{ef}	[mm]	30	40	60	30	40	70	40	50	80
Tensile $N_{rec}^a)$											
HSA, HSA-BW	[kN]		2,9	3,6	4,3	4,0	6,1	7,6	6,1	8,5	11,9
HSA-R2, HSA-R	[kN]		2,9	3,6	4,3	4,0	6,1	7,6	6,1	8,5	11,9
Shear $V_{rec}^a)$											
HSA, HSA-BW	[kN]		3,7	3,7	3,7	4,0	6,1	6,1	10,8	10,8	10,8
HSA-R2, HSA-R	[kN]		4,0	4,1	4,1	4,0	7,0	7,0	12,9	12,9	12,9

Anchor size			M12			M16			M20		
Effective anchorage depth	h_{ef}	[mm]	50	65	100	65	80	120	75	100	115
Tensile $N_{rec}^a)$											
HSA, HSA-BW	[kN]		8,5	12,6	16,7	12,6	17,2	23,8	15,6	24,0	29,7
HSA-R2, HSA-R	[kN]		8,5	12,6	16,7	12,6	17,2	23,8	15,6	24,0	29,7
Shear $V_{rec}^a)$											
HSA, HSA-BW	[kN]		16,9	16,9	16,9	29,1	29,1	29,1	31,2	49,0	49,0
HSA-R2, HSA-R	[kN]		16,7	16,7	16,7	32,3	32,3	32,3	31,2	52,5	52,5

a) With overall partial safety factor for action $\gamma = 1,4$. The partial safety factors for action depend on the type of loading and shall be taken from national regulations.

Materials

Mechanical properties

Anchor size			M6	M8	M10	M12	M16	M20
Nominal tensile strength $f_{uk,thread}$	HSA HSA-BW	[N/mm ²]	650	580	650	700	650	700
	HSA-R2 HSA-R	[N/mm ²]	650	560	650	580	600	625
Yield strength $f_{yk,thread}$	HSA HSA-BW	[N/mm ²]	520	464	520	560	520	560
	HSA-R2 HSA-R	[N/mm ²]	520	448	520	464	480	500
Stressed cross-section $A_{s,thread}$	HSA HSA-BW HSA-R2 HSA-R	[mm ²]	20,1	36,6	58,0	84,3	157,0	245,0
Moment of resistance W	HSA HSA-BW HSA-R2 HSA-R	[mm ³]	12,7	31,2	62,3	109,2	277,5	540,9
Char. bending resistance $M^0_{Rk,s}$	HSA HSA-BW	[Nm]	9,9	21,7	48,6	91,7	216,4	454,4
	HSA-R2 HSA-R	[Nm]	9,9	21,0	48,6	76,0	199,8	405,7

Material quality

Type	Part	Material	Coating
HSA HSA-BW Carbon Steel	Bolt	Carbon-steel	Galvanized ($\geq 5 \mu\text{m}$)
	Sleeve	Carbon-steel	
	Washer	HSA :carbon steel, HSA-BW: carbon steel	
	Hexagon nut	Steel, strength class 8	
HSA-R2 Stainless Steel Grade A2	Bolt	Stainless steel A2, 1.4301 or 1.4162	M6 - M20 coated
	Sleeve	Stainless steel A2, 1.4301 or 1.4404	-
	Washer	Stainless steel grade A2	-
	Hexagon nut	Stainless steel grade A2	M6 - M20 coated
HSA-R Stainless Steel Grade A4	Bolt	Stainless steel grade A4, 1.4401 or 1.4362	M6 - M20 coated
	Sleeve	Stainless steel A2, 1.4301 or 1.4404	-
	Washer	Stainless steel grade A4	-
	Hexagon nut	Stainless steel grade A4	M6 - M20 coated

Geometry washer

Anchor Size		M6	M8	M10	M12	M16	M20
Inner diameter d_1							
HSA, HSA-R2/ R	d_1 [mm]	6,4	8,4	10,5	13,0	17,0	21
HSA-BW	d_1 [mm]	6,4	8,4	10,5	13,0	17,0	22
Outer diameter d_2							
HSA, HSA-R2/ R	d_2 [mm]	12,0	16,0	20,0	24,0	30,0	37,0
HSA-BW	d_2 [mm]	18,0	24,0	30,0	37,0	50,0	60,0
Thickness h							
HSA, HSA-R2/ R	h [mm]	1,6	1,6	2,0	2,5	3,0	3,0
HSA-BW	h [mm]	1,8	2,0	2,5	3,0	3,0	4,0

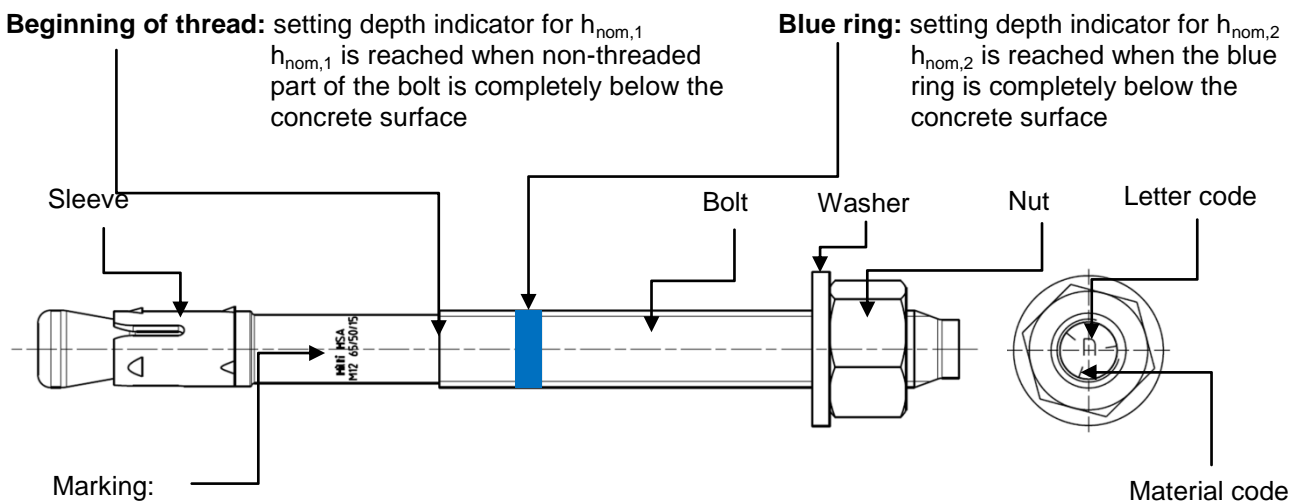

Anchor dimensions and coding

Product marking and identification of anchor



e.g.
 Hilti HSA ... Brand and Anchor type
 M12 65/50/15 ... Anchor Size and the max. $t_{fix,1}/t_{fix,2}/t_{fix,3}$ for the corresponding $h_{nom,1}/h_{nom,2}/h_{nom,3}$

Material code for identification of different materials

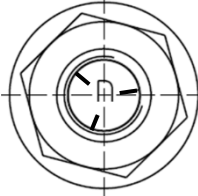
Type	HSA/ HSA-BW (carbon steel)	HSA-R2 (stainless steel grade A2)	HSA-R (stainless steel grade A4)
Material Code	 <p>Letter code without mark</p>	 <p>Letter code with two marks</p>	 <p>Letter code with three marks</p>

Effective and nominal anchorage depth

Anchor size			M6			M8			M10		
Effective anchorage depth	h_{ef}	[mm]	30	40	60	30	40	70	40	50	80
Nominal anchorage depth	h_{nom}	[mm]	37	47	67	39	49	79	50	60	90

Anchor size			M12			M16			M20		
Effective anchorage depth	h_{ef}	[mm]	50	65	100	65	80	120	75	100	115
Nominal anchorage depth	h_{nom}	[mm]	64	79	114	77	92	132	90	115	130

Letter code for anchor length and maximum thickness of the fixture t_{fix}

Type	HSA, HSA-BW, HSA-R2, HSA-R					
Size	M6	M8	M10	M12	M16	M20
h_{nom} [mm]	37 / 47 / 67	39 / 49 / 79	50 / 60 / 90	64 / 79 / 114	77 / 92 / 132	90 / 115 / 130
Letter \ t_{fix}	$t_{fix,1}/t_{fix,2}/t_{fix,3}$	$t_{fix,1}/t_{fix,2}/t_{fix,3}$	$t_{fix,1}/t_{fix,2}/t_{fix,3}$	$t_{fix,1}/t_{fix,2}/t_{fix,3}$	$t_{fix,1}/t_{fix,2}/t_{fix,3}$	$t_{fix,1}/t_{fix,2}/t_{fix,3}$
z	5/-/-	5/-/-	5/-/-	5/ -/-	5/-/-	5/-/-
y	10/-/-	10/-/-	10/-/-	10/-/-	10/-/-	10/-/-
x	15/5/-	15/5/-	15/5/-	15/-/-	15/-/-	15/-/-
w	20/10/-	20/10/-	20/10/-	20/5/-	20/5/-	20/-/-
v	25/15/-	25/15/-	25/15	25/10/-	25/10/-	25/-/-
u	30/20/-	30/20/-	30/20/-	30/15/-	30/15/-	30/5/-
t	35/25/5	35/25/-	35/25/-	35/20/-	35/20/-	35/10/-
s	40/30/10	40/30/-	40/30/-	40/25/-	40/25/-	40/15/-
r	45/35/15	45/35/5	45/35/5	45/30/-	45/30/-	45/20/5
q	50/40/20	50/40/10	50/40/10	50/35/-	50/35/-	50/25/10
p	55/45/25	55/45/15	55/45/15	55/40/5	55/40/-	55/30/15
o	60/50/30	60/50/20	60/50/20	60/45/10	60/45/5	60/35/20
n	65/55/35	65/55/25	65/55/25	65/50/15	65/50/10	65/40/25
m	70/60/40	70/60/30	70/60/30	70/55/20	70/55/15	70/45/30
l	75/65/45	75/65/35	75/65/35	75/60/25	75/60/20	75/50/35
k	80/70/50	80/70/40	80/70/40	80/65/30	80/65/25	80/55/40
j	85/75/55	85/75/45	85/75/45	85/70/35	85/70/30	85/60/45
i	90/80/60	90/80/50	90/80/50	90/75/40	90/75/35	90/65/50
h	95/85/65	95/85/55	95/85/55	95/80/45	95/80/40	95/70/55
g	100/90/70	100/90/60	100/90/60	100/85/50	100/85/45	100/75/60
f	105/95/75	105/95/65	105/95/65	105/90/55	105/90/50	105/80/65
e	110/100/80	110/100/70	110/100/70	110/95/60	110/95/55	110/85/70
d	115/105/85	115/105/75	115/105/75	115/100/65	115/100/60	115/90/75
c	120/110/90	120/110/80	120/110/80	125/110/75	120/105/65	120/95/80
b	125/115/95	125/115/85	125/115/85	135/120/85	125/110/70	125/100/85
a	130/120/100	130/120/90	130/120/90	145/130/95	135/120/80	130/105/90

Anchor length in bolt type and grey shaded are standard items. For selection of other anchor length, check availability of the items.

Setting

Installation equipment

Anchor size	M6	M8	M10	M12	M16	M20
Rotary hammer	TE2 – TE16					TE40 – TE70
Other tools	hammer, torque wrench, blow out pump					

Setting instruction

Drill and clean borehole

Standard drilling method
M6 – M20: Hammer drilling (HD)

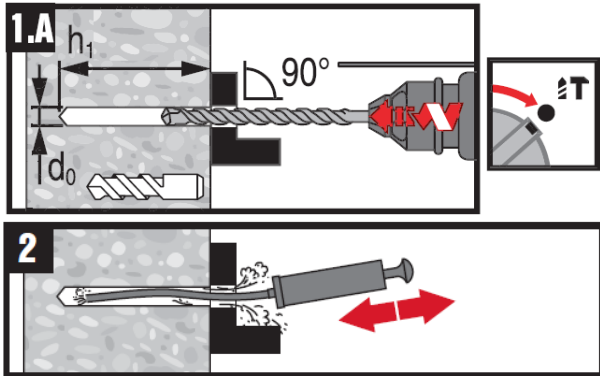

Alternative drilling method
M12 – M20: Diamond drilling (DD)

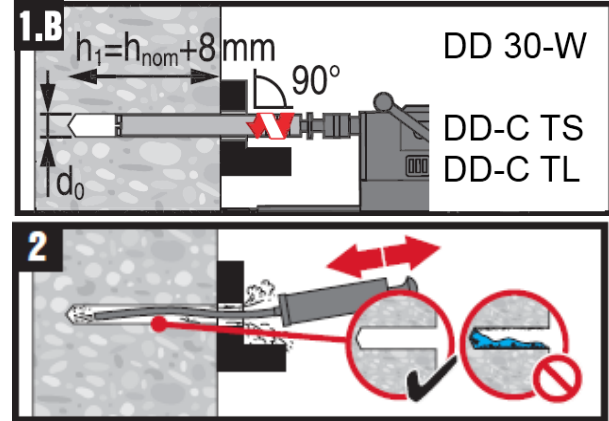

Install anchor with hammer or machine setting tool

Standard setting method
M6 – M20: Hammer setting

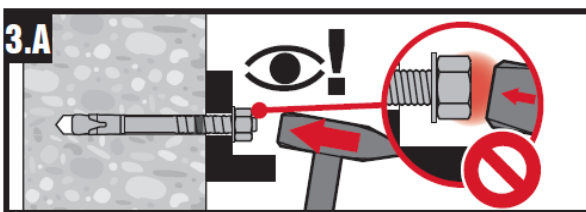

Alternative setting method
M8 – M16: Machine setting

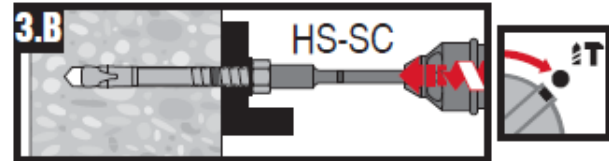

Check setting

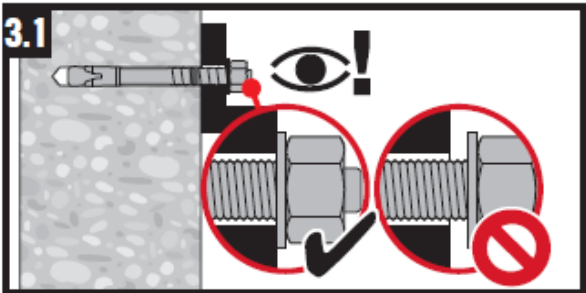

Tightening the anchor

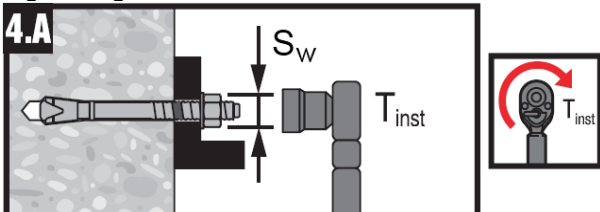

For detailed information on installation see instruction for use given with the package of the product.

Machine tightening of the anchor for standard installation torque

Type	HSA, HSA-BW, HSA-R2, HSA-R																				
	M6			M8			M10			M12			M16			M20					
Setting position	①	②	③	①	②	③	①	②	③	①	②	③	①	②	③	①	②	③			
Nominal anchorage depth h_{nom} [mm]	37	47	67	39	49	79	50	60	90	64	79	114	77	92	132	90	115	130			
Standard installation torque T_{inst} [Nm]	-			15			25			50			80			-					
Setting tool	-			S-TB HSA M8			S-TB HSA M10			S-TB HSA M12			S-TB HSA M16			-					
Impact screw driver	-			Hilti SIW 14-A Hilti SIW 22-A									Hilti SIW 22T-A			-					
Speed	-			1			1			3			_1)			-					
Setting time t_{set} [sec.]	-			3			3			3			_1)			-					
	-			3			3			3			_1)			-					
	-			4															-		

1) The impact screw driver operates with a fixed speed.

Setting instruction for HSA, HSA-BW, HSA-R2 and HSA-R M8 – M16

Tightening the anchor - alternatively with impact screw driver and special socket

Selecting the impact screw driver, battery and special socket

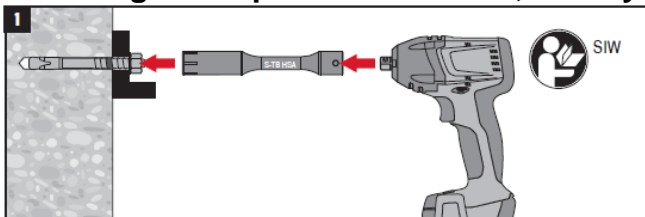

			SIW HSA M8	SIW HSA M10	SIW HSA M12	SIW HSA M16
SIW 14-A	14V	1.6Ah / 3.3Ah	✓	✓	✓	-
SIW 22-A	22V	1.6Ah / 2.6Ah / 3.3Ah	✓	✓	✓	-
SIW 22T-A	22V	2.6Ah / 3.3Ah	-	-	-	✓

Selecting the speed setting and state of charge of the battery

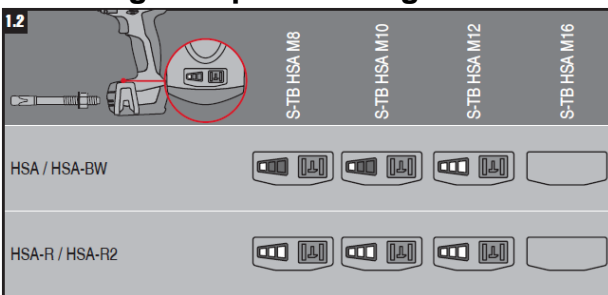

	≤ 5°	5° ... 10°	≥ 10°
HSA / HSA-BW	-	-	-
HSA-R / HSA-R2	-	-	✓
	-	-	✓
	-	✓	✓

Tighten the anchor and check the installation

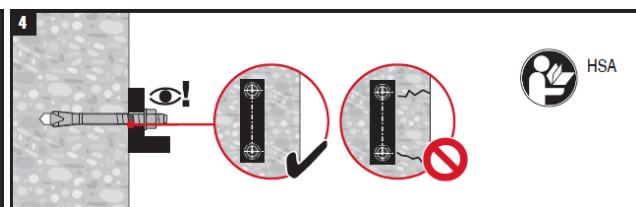
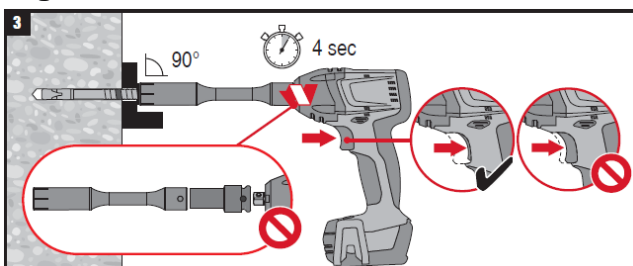

For detailed information on installation see instruction for use given with the package of the product.

Setting details

One anchor length for different fixture thickness t_{fix} and the corresponding setting positions

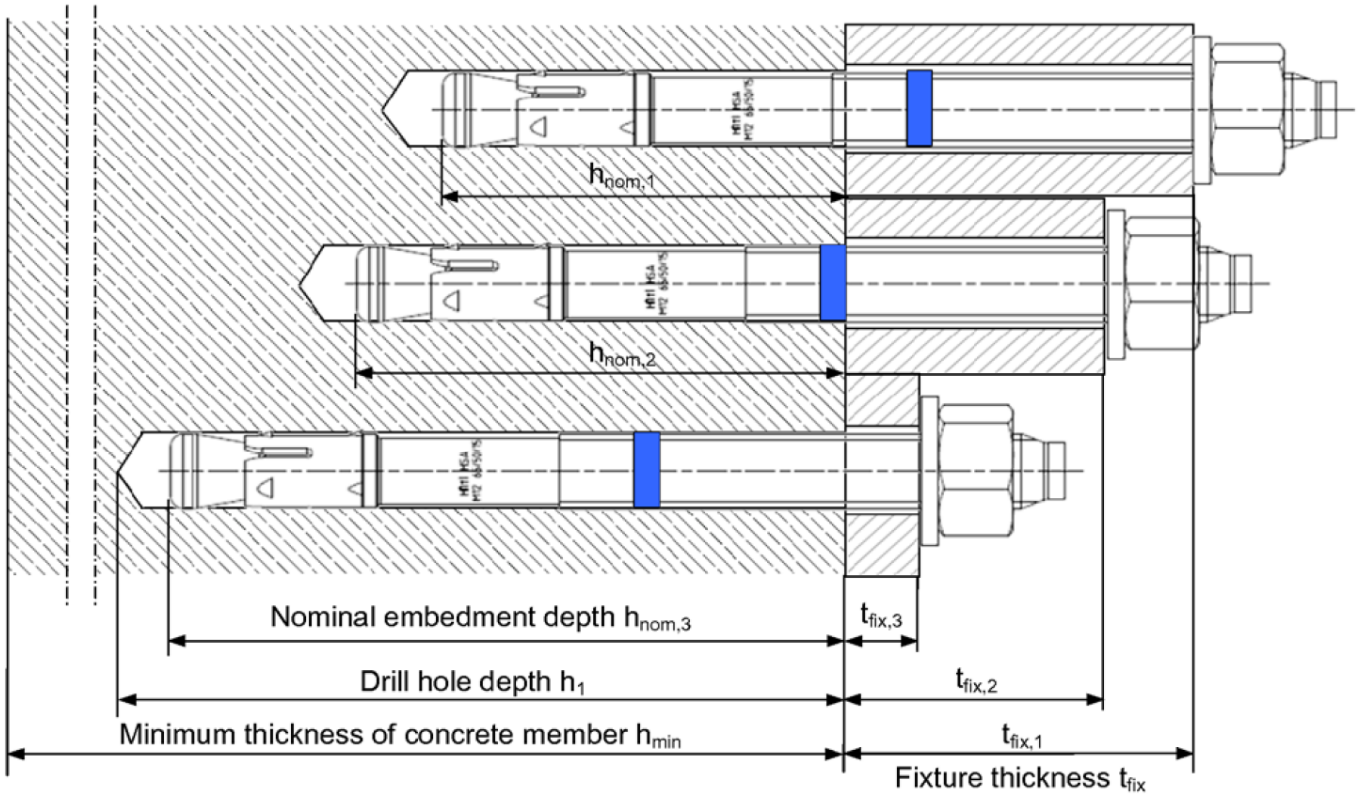

Different anchor length for different setting positions and the corresponding fixture thickness t_{fix}

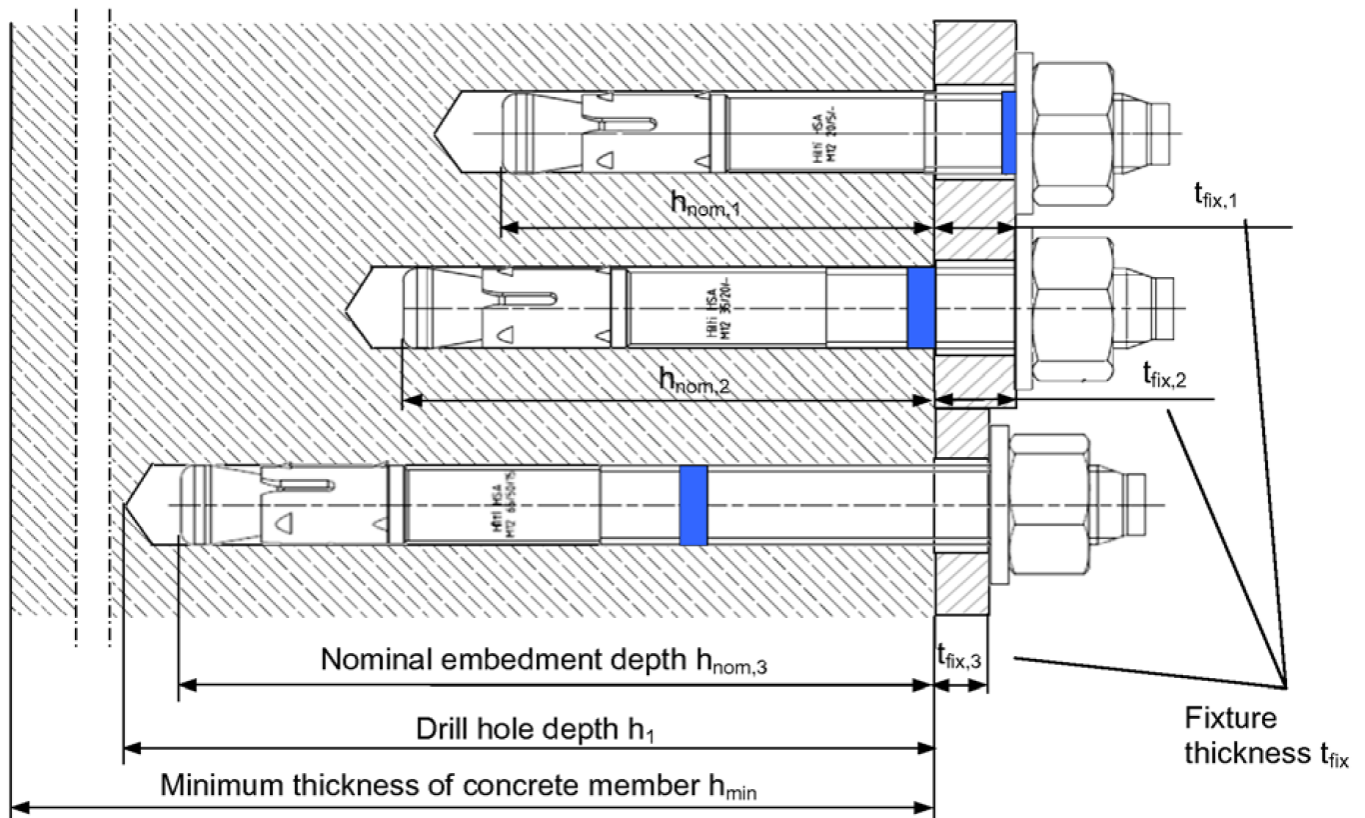

Setting details

Anchor size		M6			M8			M10		
Nominal anchorage depth	h_{nom} [mm]	37	47	67	39	49	79	50	60	90
Minimum base material thickness	h_{min} [mm]	100	100	120	100	100	120	100	120	160
Minimum spacing	s_{min} [mm]	35	35	35	35	35	35	50	50	50
Minimum edge distance	c_{min} [mm]	35	35	35	40	35	35	50	40	40
Nominal diameter of drill bit	d_o [mm]	6			8			10		
Cutting diameter of drill bit	$d_{\text{cut}} \leq$ [mm]	6,4			8,45			10,45		
Depth of drill hole	$h_1 \geq$ [mm]	42	52	72	44	54	84	55	65	95
Diameter of clearance hole in the fixture	$d_f \leq$ [mm]	7			9			12		
Torque moment	T_{inst} [Nm]	5			15			25		
Width across	SW [mm]	10			13			17		

Anchor size		M12			M16			M20		
Nominal anchorage depth	h_{nom} [mm]	64	79	114	77	92	132	90	115	130
Minimum base material thickness	h_{min} [mm]	100	140	180	140	160	180	160	220	220
Minimum spacing	s_{min} [mm]	70	70	70	90	90	90	195	175	175
Minimum edge distance	c_{min} [mm]	70	65	55	80	75	70	130	120	120
Nominal diameter of drill bit	d_o [mm]	12			16			20		
Cutting diameter of drill bit	$d_{\text{cut}} \leq$ [mm]	12,5			16,5			20,55		
Depth of drill hole	$h_1 \geq$ [mm]	72	87	122	85	100	140	98	123	138
Diameter of clearance hole in the fixture	$d_f \leq$ [mm]	14			18			22		
Torque moment	T_{inst} [Nm]	50			80			200		
Width across	SW [mm]	19			24			30		

Design parameters

Anchor size		M6			M8			M10		
Nominal anchorage depth	h_{nom} [mm]	37	47	67	39	49	79	50	60	90
Effective anchorage depth	h_{ef} [mm]	30	40	60	30	40	70	40	50	80
Critical spacing for splitting failure	$s_{cr,sp}$ [mm]	100	120	130	130	180	200	190	210	290
Critical edge distance for splitting failure	$c_{cr,sp}$ [mm]	50	60	65	65	90	100	95	105	145
Critical spacing for concrete cone failure	$s_{cr,N}$ [mm]	90	120	180	90	120	210	120	150	240
Critical edge distance for concrete cone failure	$c_{cr,N}$ [mm]	45	60	90	45	60	105	60	75	120

Anchor size		M12			M16			M20		
Nominal anchorage depth	h_{nom} [mm]	64	79	114	77	92	132	90	115	130
Effective anchorage depth	h_{ef} [mm]	50	65	100	65	80	120	75	100	115
Critical spacing for splitting failure	$s_{cr,sp}$ [mm]	200	250	310	230	280	380	260	370	400
Critical edge distance for splitting failure	$c_{cr,sp}$ [mm]	100	125	155	115	140	190	130	185	200
Critical spacing for concrete cone failure	$s_{cr,N}$ [mm]	150	195	300	195	240	360	225	300	345
Critical edge distance for concrete cone failure	$c_{cr,N}$ [mm]	75	97,5	150	97,5	120	180	112,5	150	172,5

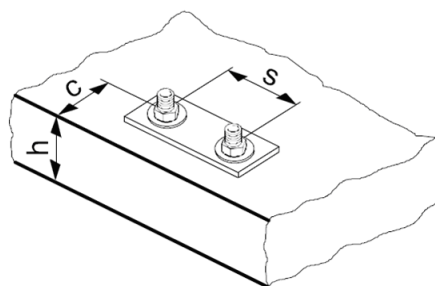

For spacing (edge distance) smaller than critical spacing (critical edge distance) the design loads have to be reduced.

Simplified design method

Simplified version of the design method according ETAG 001, Annex C. Design resistance according ETA-11/0374, issue 2012-07-19.

- Influence of concrete strength
- Influence of edge distance
- Influence of spacing
- Valid for a group of two anchors. (The method may also be applied for anchor groups with more than two anchors or more than one edge. The influencing factors must then be considered for each edge distance and spacing. The calculated design loads are then conservative: They will be lower than the exact values according ETAG 001, Annex C. To avoid this, it is recommended to use the anchor design software PROFIS anchor)

The design method is based on the following simplification:

- No different loads are acting on individual anchors (no eccentricity)

The values are valid for one anchor.

For more complex fastening applications please use the anchor design software PROFIS Anchor.

Tension loading

The design tensile resistance is the lower value of

- Steel resistance: $N_{Rd,s}$
- Concrete pull-out resistance: $N_{Rd,p} = N_{Rd,p}^0 \cdot f_B$
- Concrete cone resistance: $N_{Rd,c} = N_{Rd,c}^0 \cdot f_B \cdot f_{1,N} \cdot f_{2,N} \cdot f_{3,N} \cdot f_{re,N}$
- Concrete splitting resistance (only non-cracked concrete):
 $N_{Rd,sp} = N_{Rd,c}^0 \cdot f_B \cdot f_{1,sp} \cdot f_{2,sp} \cdot f_{3,sp} \cdot f_{h,sp} \cdot f_{re,N}$

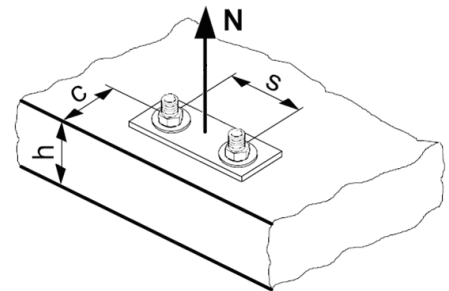

Basic design tensile resistance

Design steel resistance $N_{Rd,s}$

Anchor size		M6	M8	M10	M12	M16	M20
$N_{Rd,s}$	HSA, HSA-BW [kN]	6,4	11,8	20,0	29,6	59,0	88,5
	HSA-R2, HSA-R [kN]	8,7	13,1	25,0	31,9	62,6	68,5

Design pull-out resistance $N_{Rd,p} = N_{Rd,p}^0 \cdot f_B$

Anchor size			M6			M8			M10		
Effective anchorage depth	h_{ef}	[mm]	30	40	60	30	40	70	40	50	80
$N_{Rd,p}^0$	HSA, HSA-BW, HSA-R2, HSA-R	[kN]	4,0	5,0	6,0	No pull-out		10,7	No pull-out		16,7

Anchor size			M12			M16			M20		
Effective anchorage depth	h_{ef}	[mm]	50	65	100	65	80	120	75	100	115
$N_{Rd,p}^0$	HSA, HSA-BW, HSA-R2, HSA-R	[kN]	No pull-out		23,3	No pull-out		33,3	No pull-out		

Design concrete cone resistance $N_{Rd,c} = N_{Rd,c}^0 \cdot f_B \cdot f_{1,N} \cdot f_{2,N} \cdot f_{3,N} \cdot f_{re,N}$

Design splitting resistance $N_{Rd,sp} = N_{Rd,c}^0 \cdot f_B \cdot f_{1,sp} \cdot f_{2,sp} \cdot f_{3,sp} \cdot f_{h,sp} \cdot f_{re,N}$

Anchor size			M6			M8			M10		
Effective anchorage depth	h_{ef}	[mm]	30	40	60	30	40	70	40	50	80
$N_{Rd,p}^0$	HSA, HSA-BW, HSA-R2, HSA-R	[kN]	5,5	8,5	15,6	5,5	8,5	19,7	8,5	11,9	24,1

Anchor size			M12			M16			M20		
Effective anchorage depth	h_{ef}	[mm]	50	65	100	65	80	120	75	100	115
$N_{Rd,p}^0$	HSA, HSA-BW, HSA-R2, HSA-R	[kN]	11,9	17,6	33,7	17,6	24,1	44,3	21,9	33,7	41,5

Influencing factors

Influence of concrete strength

Concrete strength designation (ENV 206)	C 20/25	C 25/30	C 30/37	C 35/45	C 40/50	C 45/55	C 50/60
Pull-out, concrete cone and splitting resistance							
$f_B = (f_{ck,cube}/25N/mm^2)^{1/2}$ a)	1	1,1	1,22	1,34	1,41	1,48	1,55

a) $f_{ck,cube}$ = concrete compressive strength, measured on cubes with 150 mm side length

Influence of edge distance a)

$c/c_{cr,N}$	0,1	0,2	0,3	0,4	0,5	0,6	0,7	0,8	0,9	1
$c/c_{cr,sp}$										
$f_{1,N} = 0,7 + 0,3 \cdot c/c_{cr,N} \leq 1$	0,73	0,76	0,79	0,82	0,85	0,88	0,91	0,94	0,97	1
$f_{1,sp} = 0,7 + 0,3 \cdot c/c_{cr,sp} \leq 1$										
$f_{2,N} = 0,5 \cdot (1 + c/c_{cr,N}) \leq 1$	0,55	0,60	0,65	0,70	0,75	0,80	0,85	0,90	0,95	1
$f_{2,sp} = 0,5 \cdot (1 + c/c_{cr,sp}) \leq 1$										

a) The edge distance shall not be smaller than the minimum edge distance c_{min} given in the table with the setting details. These influencing factors must be considered for every edge distance.

Influence of anchor spacing ^{a)}

$s/s_{cr,N}$	0,1	0,2	0,3	0,4	0,5	0,6	0,7	0,8	0,9	1
$s/s_{cr,sp}$										
$f_{3,N} = 0,5 \cdot (1 + s/s_{cr,N}) \leq 1$	0,55	0,60	0,65	0,70	0,75	0,80	0,85	0,90	0,95	1
$f_{3,sp} = 0,5 \cdot (1 + s/s_{cr,sp}) \leq 1$										

a) The anchor spacing shall not be smaller than the minimum anchor spacing s_{min} given in the table with the setting details. This influencing factor must be considered for every anchor spacing.

Influence of base material thickness

h/h_{min}	1,0	1,1	1,2	1,3	1,4	1,5	1,6	1,7	1,8	$\geq 1,84$
$f_{h,sp} = [h/(h_{min})]^{2/3}$	1	1,07	1,13	1,19	1,25	1,31	1,37	1,42	1,48	1,5

Influence of reinforcement ^{a)}

Anchor size	M6			M8			M10		
Effective anchorage depth h_{ef} [mm]	30	40	60	30	40	70	40	50	80
$f_{re,N} = 0,5 + h_{ef}/200mm \leq 1$	0,65	0,7	0,8	0,65	0,7	0,85	0,7	0,75	0,9

Anchor size	M12			M16			M20		
Effective anchorage depth h_{ef} [mm]	50	65	100	65	80	120	75	100	115
$f_{re,N} = 0,5 + h_{ef}/200mm \leq 1$	0,75	0,83	1	0,83	0,9	1	0,88	1	1

a) This factor applies only for dense reinforcement. If in the area of anchorage there is reinforcement with a spacing ≥ 150 mm (any diameter) or with a diameter ≤ 10 mm and a spacing ≥ 100 mm, then a factor $f_{re,N} = 1$ may be applied.

Shear loading

The design shear resistance is the lower value of

- Steel resistance: $V_{Rd,s}$
- Concrete pryout resistance: $V_{Rd,cp} = k \cdot N_{Rd,c}$
- Concrete edge resistance: $V_{Rd,c} = V_{Rd,c}^0 \cdot f_B \cdot f_{\beta} \cdot f_h \cdot f_4 \cdot f_{hef} \cdot f_c$

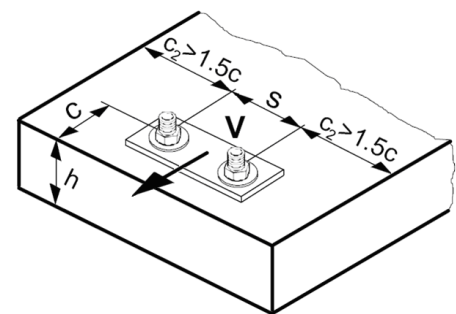

Basic design shear resistance

Design steel resistance $V_{Rd,s}$

Anchor size		M6	M8	M10	M12	M16	M20
$V_{Rd,s}$	HSA, HSA-BW [kN]	5,2	8,5	15,1	23,6	40,8	68,6
	HSA-R2, HSA-R [kN]	5,8	9,8	18,1	23,4	45,2	73,5

Design concrete pryout resistance $V_{Rd,cp} = k \cdot N_{Rd,c}$ ^{a)}

Anchor size	M6			M8			M10		
Effective anchorage depth h_{ef} [mm]	30	40	60	30	40	70	40	50	80
k	1	1	2	1	1,5	2	2,4	2,4	2,4

Anchor size	M12			M16			M20		
Effective anchorage depth h_{ef} [mm]	50	65	100	65	80	120	75	100	115
k	2	2	2	2,9	2,9	2,9	2	3,5	3,5

a) $N_{Rd,c}$: Design concrete cone resistance

Design concrete edge resistance $V_{Rd,c}^0 = V_{Rd,c}^0 \cdot f_B \cdot f_{\beta} \cdot f_h \cdot f_4 \cdot f_{hef} \cdot f_c$

Anchor size	M6			M8			M10		
Effective anchorage depth h_{ef} [mm]	30	40	60	30	40	70	40	50	80
$V_{Rd,c}^0$ [kN]	3,6	3,6	3,7	5,8	5,9	6,0	8,5	8,5	8,6

Anchor size	M12			M16			M20		
Effective anchorage depth h_{ef} [mm]	50	65	100	65	80	120	75	100	115
$V_{Rd,c}^0$ [kN]	11,6	11,6	11,7	18,7	18,8	18,9	27,2	27,3	27,4

a) For anchor groups only the anchors close to the edge must be considered.

Influencing factors

Influence of concrete strength

Concrete strength designation (ENV 206)	C 20/25	C 25/30	C 30/37	C 35/45	C 40/50	C 45/55	C 50/60
$f_B = (f_{ck,cube}/25N/mm^2)^{1/2}$ ^{a)}	1	1,1	1,22	1,34	1,41	1,48	1,55

a) $f_{ck,cube}$ = concrete compressive strength, measured on cubes with 150 mm side length

Influence of angle between load applied and the direction perpendicular to the free edge

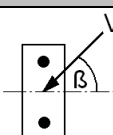
Angle β	0°	10°	20°	30°	40°	50°	60°	70°	80°	≥ 90°
$f_{\beta} = \sqrt{\frac{1}{(\cos \alpha_v)^2 + \left(\frac{\sin \alpha_v}{2,5}\right)^2}}$ 	1	1,01	1,05	1,13	1,24	1,40	1,64	1,97	2,32	2,50

Influence of base material thickness

h/c	0,15	0,3	0,45	0,6	0,75	0,9	1,05	1,2	1,35	≥ 1,5
$f_h = \{h/(1,5 \cdot c)\}^{1/2} \leq 1$	0,32	0,45	0,55	0,63	0,71	0,77	0,84	0,89	0,95	1,00

Influence of anchor spacing and edge distance ^{a)} for concrete edge resistance: f_4

$$f_4 = (c/h_{ef})^{1,5} \cdot (1 + s / [3 \cdot c]) \cdot 0,5$$

c/h_{ef}	Single anchor	Group of two anchors s/h_{ef}														
		0,75	1,50	2,25	3,00	3,75	4,50	5,25	6,00	6,75	7,50	8,25	9,00	9,75	10,50	11,25
0,50	0,35	0,27	0,35	0,35	0,35	0,35	0,35	0,35	0,35	0,35	0,35	0,35	0,35	0,35	0,35	0,35
0,75	0,65	0,43	0,54	0,65	0,65	0,65	0,65	0,65	0,65	0,65	0,65	0,65	0,65	0,65	0,65	0,65
1,00	1,00	0,63	0,75	0,88	1,00	1,00	1,00	1,00	1,00	1,00	1,00	1,00	1,00	1,00	1,00	1,00
1,25	1,40	0,84	0,98	1,12	1,26	1,40	1,40	1,40	1,40	1,40	1,40	1,40	1,40	1,40	1,40	1,40
1,50	1,84	1,07	1,22	1,38	1,53	1,68	1,84	1,84	1,84	1,84	1,84	1,84	1,84	1,84	1,84	1,84
1,75	2,32	1,32	1,49	1,65	1,82	1,98	2,15	2,32	2,32	2,32	2,32	2,32	2,32	2,32	2,32	2,32
2,00	2,83	1,59	1,77	1,94	2,12	2,30	2,47	2,65	2,83	2,83	2,83	2,83	2,83	2,83	2,83	2,83
2,25	3,38	1,88	2,06	2,25	2,44	2,63	2,81	3,00	3,19	3,38	3,38	3,38	3,38	3,38	3,38	3,38
2,50	3,95	2,17	2,37	2,57	2,77	2,96	3,16	3,36	3,56	3,76	3,95	3,95	3,95	3,95	3,95	3,95
2,75	4,56	2,49	2,69	2,90	3,11	3,32	3,52	3,73	3,94	4,15	4,35	4,56	4,56	4,56	4,56	4,56
3,00	5,20	2,81	3,03	3,25	3,46	3,68	3,90	4,11	4,33	4,55	4,76	4,98	5,20	5,20	5,20	5,20
3,25	5,86	3,15	3,38	3,61	3,83	4,06	4,28	4,51	4,73	4,96	5,18	5,41	5,63	5,86	5,86	5,86
3,50	6,55	3,51	3,74	3,98	4,21	4,44	4,68	4,91	5,14	5,38	5,61	5,85	6,08	6,31	6,55	6,55
3,75	7,26	3,87	4,12	4,36	4,60	4,84	5,08	5,33	5,57	5,81	6,05	6,29	6,54	6,78	7,02	7,26
4,00	8,00	4,25	4,50	4,75	5,00	5,25	5,50	5,75	6,00	6,25	6,50	6,75	7,00	7,25	7,50	7,75
4,25	8,76	4,64	4,90	5,15	5,41	5,67	5,93	6,18	6,44	6,70	6,96	7,22	7,47	7,73	7,99	8,25
4,50	9,55	5,04	5,30	5,57	5,83	6,10	6,36	6,63	6,89	7,16	7,42	7,69	7,95	8,22	8,49	8,75
4,75	10,35	5,45	5,72	5,99	6,27	6,54	6,81	7,08	7,36	7,63	7,90	8,17	8,45	8,72	8,99	9,26
5,00	11,18	5,87	6,15	6,43	6,71	6,99	7,27	7,55	7,83	8,11	8,39	8,66	8,94	9,22	9,50	9,78
5,25	12,03	6,30	6,59	6,87	7,16	7,45	7,73	8,02	8,31	8,59	8,88	9,17	9,45	9,74	10,02	10,31
5,50	12,90	6,74	7,04	7,33	7,62	7,92	8,21	8,50	8,79	9,09	9,38	9,67	9,97	10,26	10,55	10,85

- a) The anchor spacing and the edge distance shall not be smaller than the minimum anchor spacing s_{min} and the minimum edge distance c_{min} .

Influence of embedment depth

Anchor size	M6			M8			M10		
Effective anchorage depth h_{ef} [mm]	30	40	60	30	40	70	40	50	80
$f_{hef} = 0,05 \cdot (h_{ef} / d)^{1,68}$	0,75	1,21	2,39	0,46	0,75	1,91	0,51	0,75	1,64

Anchor size	M12			M16			M20		
Effective anchorage depth h_{ef} [mm]	50	65	100	65	80	120	75	100	115
$f_{hef} = 0,05 \cdot (h_{ef} / d)^{1,68}$	0,55	0,85	1,76	0,53	0,75	1,48	0,46	0,75	0,94

Influence of edge distance ^{a)}

c/d	4	6	8	10	15	20	30	40
$f_c = (d / c)^{0,19}$	0,77	0,71	0,67	0,65	0,60	0,57	0,52	0,50

- a) The edge distance shall not be smaller than the minimum edge distance c_{min} .

Combined tension and shear loading

For combined tension and shear loading see section "Anchor Design".

Precalculated values

Design resistance calculated according ETAG 001, Annex C and Hilti technical data.
All data applies to concrete C 20/25 – $f_{ck,cube} = 25 \text{ N/mm}^2$.

Recommended loads can be calculated by dividing the design resistance by an overall partial safety factor for action $\gamma = 1,4$. The partial safety factors for action depend on the type of loading and shall be taken from national regulations.

Design resistance

Single anchor, no edge effects

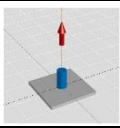
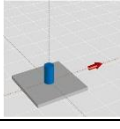
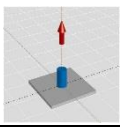
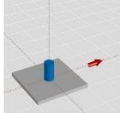
Anchor size		M6			M8			M10			
Effective anchorage depth	h_{ef} [mm]	30	40	60	30	40	70	40	50	80	
Min. base material thickness h_{min} [mm]		100	100	120	100	100	120	100	120	160	
	Tensile N_{Rd}										
	HSA, HSA-BW	[kN]	4,0	5,0	6,0	5,5	8,5	10,7	8,5	11,9	16,7
	HSA-R2, HSA-R	[kN]	4,0	5,0	6,0	5,5	8,5	10,7	8,5	11,9	16,7
	Shear V_{Rd}, without lever arm										
	HSA, HSA-BW	[kN]	5,2	5,2	5,2	5,5	8,5	8,5	15,1	15,1	15,1
	HSA-R2, HSA-R	[kN]	5,5	5,8	5,8	5,5	9,8	9,8	18,1	18,1	18,1
Anchor size		M12			M16			M20			
Effective anchorage depth	h_{ef} [mm]	50	65	100	65	80	120	75	100	115	
Min. base material thickness h_{min} [mm]		100	140	180	140	160	180	160	220	220	
	Tensile N_{Rd}										
	HSA, HSA-BW	[kN]	11,9	17,6	23,3	17,6	24,1	33,3	21,9	33,7	41,5
	HSA-R2, HSA-R	[kN]	11,9	17,6	23,3	17,6	24,1	33,3	21,9	33,7	41,5
	Shear V_{Rd}, without lever arm										
	HSA, HSA-BW	[kN]	23,6	23,6	23,6	40,8	40,8	40,8	43,7	68,6	68,6
	HSA-R2, HSA-R	[kN]	23,4	23,4	23,4	45,2	45,2	45,2	43,7	73,5	73,5

Single anchor, min. edge distance ($c = c_{min}$)

Anchor size		M6			M8			M10			
Effective anchorage depth	h_{ef} [mm]	30	40	60	30	40	70	40	50	80	
Min. base material thickness	h_{min} [mm]	100	100	120	100	100	120	100	120	160	
Min. edge distance	c_{min} [mm]	35	35	35	40	35	35	50	40	40	
	Tensile N_{Rd}										
	HSA, HSA-BW	[kN]	4,0	5,0	6,0	4,0	4,8	10,5	5,6	6,7	12,0
	HSA-R2, HSA-R	[kN]	4,0	5,0	6,0	4,0	4,8	10,5	5,6	6,7	12,0
	Shear V_{Rd}, without lever arm										
	HSA, HSA-BW	[kN]	2,5	2,6	2,8	3,1	2,7	3,0	4,5	3,5	3,9
	HSA-R2, HSA-R	[kN]	2,5	2,6	2,8	3,1	2,7	3,0	4,5	3,5	3,9
Anchor size		M12			M16			M20			
Effective anchorage depth	h_{ef} [mm]	50	65	100	65	80	120	75	100	115	
Min. base material thickness	h_{min} [mm]	100	140	180	140	160	180	160	220	220	
Min. edge distance	c_{min} [mm]	70	65	55	80	75	70	130	120	120	
	Tensile N_{Rd}										
	HSA, HSA-BW	[kN]	9,2	11,5	18,4	13,6	15,9	24,5	21,9	24,8	29,2
	HSA-R2, HSA-R	[kN]	9,2	11,5	18,4	13,6	15,9	24,5	21,9	24,8	29,2
	Shear V_{Rd}, without lever arm										
	HSA, HSA-BW	[kN]	7,4	7,2	6,4	9,9	9,5	9,6	18,1	19,1	19,6
	HSA-R2, HSA-R	[kN]	7,4	7,2	6,4	9,9	9,5	9,6	18,1	19,1	19,6

Double anchor, no edge effects, min. spacing ($s = s_{min}$),
(load values are valid for one anchor)

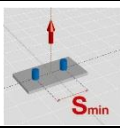
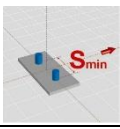
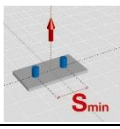
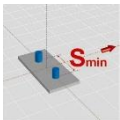
Anchor size		M6			M8			M10			
Effective anchorage depth	h_{ef} [mm]	30	40	60	30	40	70	40	50	80	
Min. base material thickness	h_{min} [mm]	100	100	120	100	100	120	100	120	160	
Min. spacing	s_{min} [mm]	35	35	35	35	35	35	50	50	50	
	Tensile N_{Rd}										
	HSA, HSA-BW	[kN]	3,7	5,0	6,0	3,5	5,1	10,7	5,4	7,4	14,1
	HSA-R2, HSA-R	[kN]	3,7	5,0	6,0	3,5	5,1	10,7	5,4	7,4	14,1
	Shear V_{Rd}, without lever arm										
	HSA, HSA-BW	[kN]	3,8	5,2	5,2	3,8	8,3	8,5	14,5	15,1	15,1
	HSA-R2, HSA-R	[kN]	3,8	5,5	5,8	3,8	8,3	9,8	14,5	18,1	18,1
Anchor size		M12			M16			M20			
Effective anchorage depth	h_{ef} [mm]	50	65	100	65	80	120	75	100	115	
Min. base material thickness	h_{min} [mm]	100	140	180	140	160	180	160	220	220	
Min. spacing	s_{min} [mm]	70	70	70	90	90	90	195	175	175	
	Tensile N_{Rd}										
	HSA, HSA-BW	[kN]	8,0	11,3	20,6	12,3	15,9	27,4	19,1	24,8	29,8
	HSA-R2, HSA-R	[kN]	8,0	11,3	20,6	12,3	15,9	27,4	19,1	24,8	29,8
	Shear V_{Rd}, without lever arm										
	HSA, HSA-BW	[kN]	17,5	23,6	23,6	37,4	40,8	40,8	40,8	68,6	68,6
	HSA-R2, HSA-R	[kN]	17,5	23,4	23,4	37,4	45,2	45,2	40,8	73,5	73,5

HSA-F Stud anchor

	Anchor version	Benefits
	HSA-F; Carbon steel, hot dipped galvanized, min 35 microns coating thickness DIN 125 washer	<ul style="list-style-type: none"> - Hot dipped galvanized material for increased corrosion resistance - Three embedment depths for maximal design flexibility - Suitable for pre- and through fastening

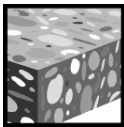

Concrete

Basic loading data (for a single anchor)

All data in this section applies to

- Correct setting (See setting instruction)
- No edge distance and spacing influence
- Steel failure
- Minimum base material thickness
- Non-cracked Concrete C 20/25, $f_{ck,cube} = 25 \text{ N/mm}^2$

For details see Simplified design method

Mean ultimate resistance

Anchor size			M6			M8			M10		
Effective anchorage depth	h_{ef}	[mm]	30	40		30	40	70	40	50	80
Tensile	$N_{Ru,m}$	[kN]	8,0	9,5		11,0	17,0	17,3	17,0	21,2	26,6
Shear	$V_{Ru,m}$	[kN]	6,8	6,8		11,0	11,1	11,1	19,8	19,8	19,8

Anchor size			M12			M16			M20		
Effective anchorage depth	h_{ef}	[mm]	50	65	100	65	80	120	75	100	115
Tensile	$N_{Ru,m}$	[kN]	23,7	33,2	33,2	26,6	39,8	53,1	43,5	67,0	82,7
Shear	$V_{Ru,m}$	[kN]	31,0	31,0	31,0	53,6	53,6	53,6	87,1	90,1	90,1

Characteristic resistance

Anchor size			M6		M8			M10		
Effective anchorage depth	h_{ef}	[mm]	30	40	30	40	70	40	50	80
Tensile	N_{Rk}	[kN]	6,0	7,5	8,3	12,8	16,0	12,8	16,0	20,0
Shear	V_{Rk}	[kN]	6,5	6,5	8,3	10,6	10,6	18,9	18,9	18,9

Anchor size			M12			M16			M20		
Effective anchorage depth	h_{ef}	[mm]	50	65	100	65	80	120	75	100	115
Tensile	N_{Rk}	[kN]	17,9	25,0	25,0	20,0	30,0	40,0	32,8	50,5	62,3
Shear	V_{Rk}	[kN]	29,5	29,5	29,5	51,0	51,0	51,0	65,6	85,8	85,8

Design resistance

Anchor size			M6		M8			M10		
Effective anchorage depth	h_{ef}	[mm]	30	40	30	40	70	40	50	80
Tensile	N_{Rd}	[kN]	4,0	5,0	5,5	8,5	10,7	8,5	10,7	13,3
Shear	V_{Rd}	[kN]	5,2	5,2	5,5	8,5	8,5	15,1	15,1	15,1

Anchor size			M12			M16			M20		
Effective anchorage depth	h_{ef}	[mm]	50	65	100	65	80	120	75	100	115
Tensile	N_{Rd}	[kN]	11,9	16,7	16,7	13,3	20,0	26,7	21,9	33,7	41,5
Shear	V_{Rd}	[kN]	23,6	23,6	23,6	40,8	40,8	40,8	43,7	68,6	68,6

Recommended loads

Anchor size			M6		M8			M10		
Effective anchorage depth	h_{ef}	[mm]	30	40	30	40	70	40	50	80
Tensile	N_{rec}	[kN]	2,9	3,6	4,0	6,1	7,6	6,1	7,6	9,5
Shear	V_{rec}	[kN]	3,7	3,7	4,0	6,1	6,1	10,8	10,8	10,8

Anchor size			M12			M16			M20		
Effective anchorage depth	h_{ef}	[mm]	50	65	100	65	80	120	75	100	115
Tensile	N_{rec}	[kN]	8,5	11,9	11,9	9,5	14,3	19,0	15,6	24,0	29,7
Shear	V_{rec}	[kN]	16,9	16,9	16,9	29,1	29,1	29,1	31,2	49,0	49,0

Materials

Mechanical properties

Anchor size		M6	M8	M10	M12	M16	M20
Nominal tensile strength $f_{uk,thread}$	[N/mm ²]	650	580	650	700	650	700
Yield strength $f_{yk,thread}$	[N/mm ²]	520	464	520	560	520	560
Stressed cross-section $A_{s,thread}$	[mm ²]	20,1	36,6	58,0	84,3	157,0	245,0
Moment of resistance W	[mm ³]	12,7	31,2	62,3	109,2	277,5	540,9
Char. bending resistance $M_{Rk,s}^0$	[Nm]	9,9	21,7	48,6	91,7	216,4	454,4

Material quality

Type	Part	Material	Coating
HSA-F Carbon Steel	Sleeve	Stainless steel A2 1.4301	-
	Bolt	Carbon steel, Rupture elongation $A_5 > 8\%$	Hot dipped galvanized ($\geq 35 \mu\text{m}$)
	Washer	HSA :carbon steel	
	Hexagon nut	Steel, strength class 8	

Geometry washer

Anchor Size		M6	M8	M10	M12	M16	M20
Inner diameter d_1							
HSA-F	d_1 [mm]	6,4	8,4	10,5	13,0	17,0	21
Outer diameter d_2							
HSA-F	d_2 [mm]	12,0	16,0	20,0	24,0	30,0	37,0
Thickness h							
HSA-F	h [mm]	1,6	1,6	2,0	2,5	3,0	3,0

Anchor dimensions and coding

Product marking and identification of anchor

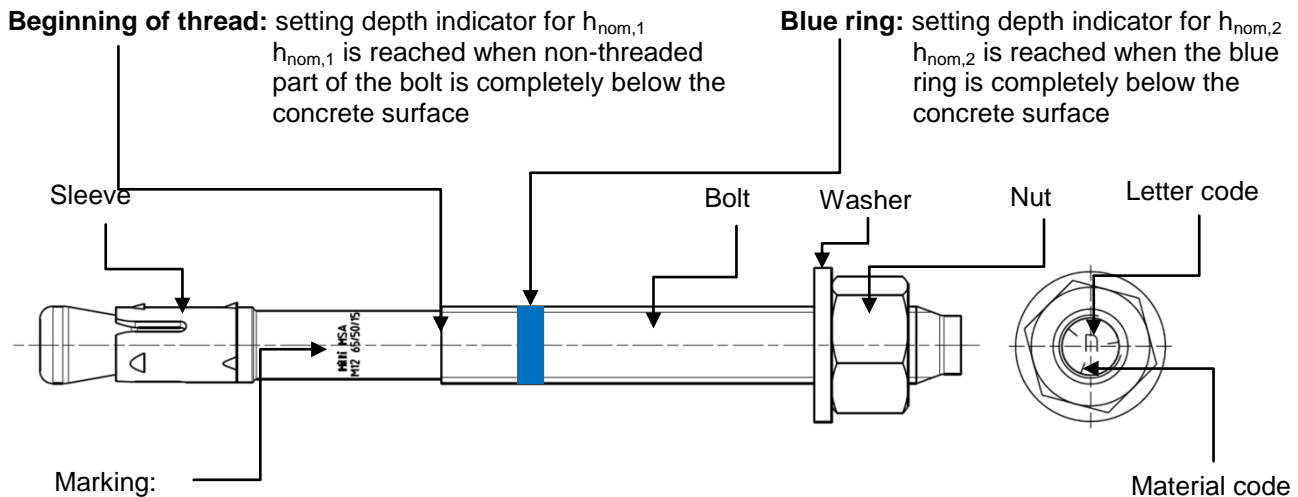

e.g.
 Hilti HSA-F ... Brand and Anchor type
 M12 65/50/15 ... Anchor Size and the max. $t_{fix,1}/t_{fix,2}/t_{fix,3}$ for the corresponding $h_{nom,1}/h_{nom,2}/h_{nom,3}$

Material code for identification of different materials

Type	HSA-F (carbon steel, hot dipped galvanized)
Material Code	 Letter code without mark

Effective and nominal anchorage depth

Anchor size	M6		M8			M10		
Effective anchorage depth h_{ef} [mm]	30	40	30	40	70	40	50	80
Nominal anchorage depth h_{nom} [mm]	37	47	39	49	79	50	60	90

Anchor size	M12			M16			M20		
Effective anchorage depth h_{ef} [mm]	50	65	100	65	80	120	75	100	115
Nominal anchorage depth h_{nom} [mm]	64	79	114	77	92	132	90	115	130

Letter code for anchor length and maximum thickness of the fixture t_{fix}

Type	HSA-F					
Size	M6	M8	M10	M12	M16	M20
h_{nom} [mm]	37 / 47 / -	39 / 49 / 79	50 / 60 / 90	64 / 79 / 114	77 / 92 / 132	90 / 115 / 130
Letter \ t_{fix}	$t_{fix,1}/t_{fix,2}/t_{fix,3}$	$t_{fix,1}/t_{fix,2}/t_{fix,3}$	$t_{fix,1}/t_{fix,2}/t_{fix,3}$	$t_{fix,1}/t_{fix,2}/t_{fix,3}$	$t_{fix,1}/t_{fix,2}/t_{fix,3}$	$t_{fix,1}/t_{fix,2}/t_{fix,3}$
z	5/-/	5/-/	5/-/	5/ -/	5/-/	
y						10/-/
w	20/10/-	20/10/-	20/10/-	20/5/-		
t		35/25/-	35/25/-	35/20/-		
s					40/25/-	
g			50/40/10			
p		55/45/15				55/30/15
n				65/50/15		
k		80/70/40				
j					85/70/30	
a				145/130/95		

Setting

Installation equipment

Anchor size	M6	M8	M10	M12	M16	M20
Rotary hammer	TE2 – TE16					TE40 – TE70
Other tools	hammer, torque wrench, blow out pump					

Setting instruction

Drill and clean borehole

Standard drilling method

M6 – M20: Hammer drilling (HD)

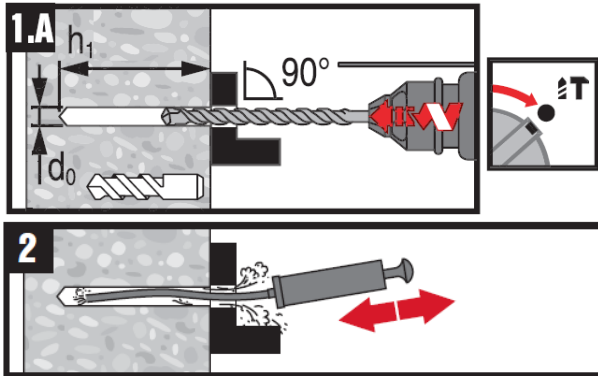

Install anchor with hammer or machine setting tool

Standard setting method

M6 – M20: Hammer setting

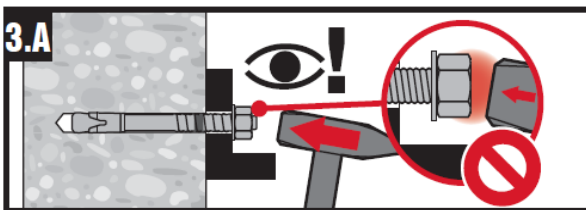

Alternative setting method

M8 – M16: Machine setting

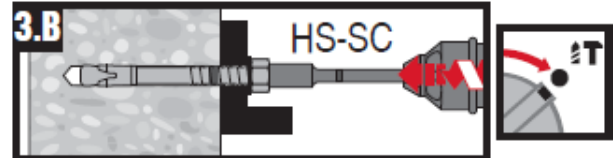

Check setting

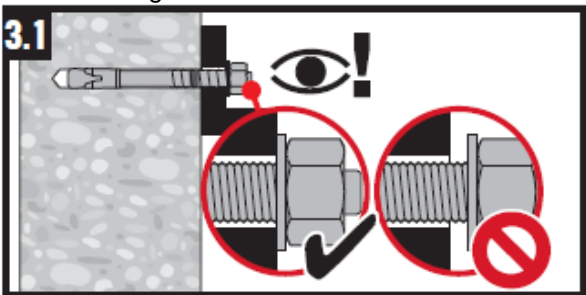

Tightening the anchor

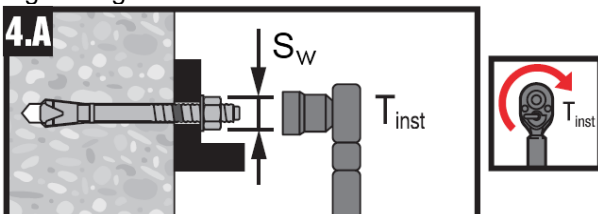

For detailed information on installation see instruction for use given with the package of the product.

Setting details

One anchor length for different fixture thickness t_{fix} and the corresponding setting positions

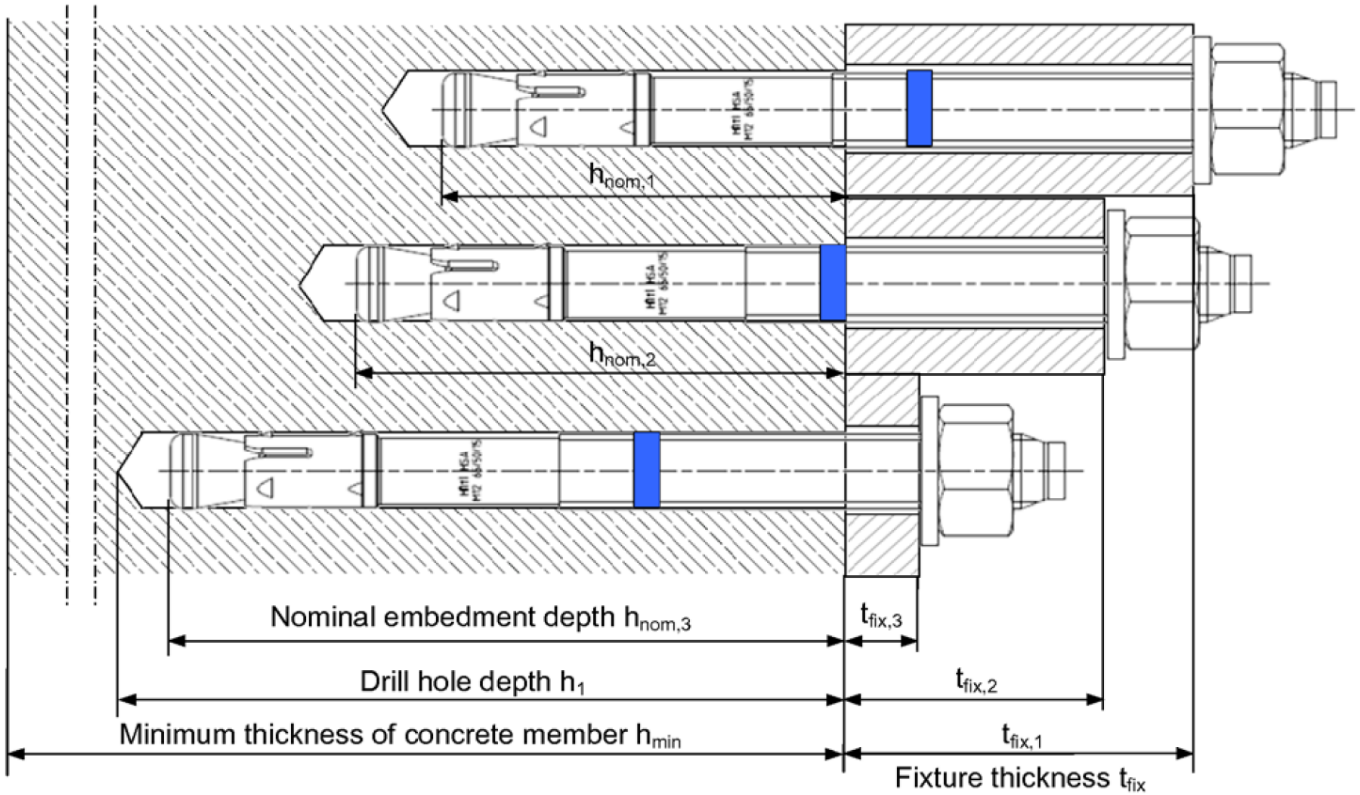

Different anchor length for different setting positions and the corresponding fixture thickness t_{fix}

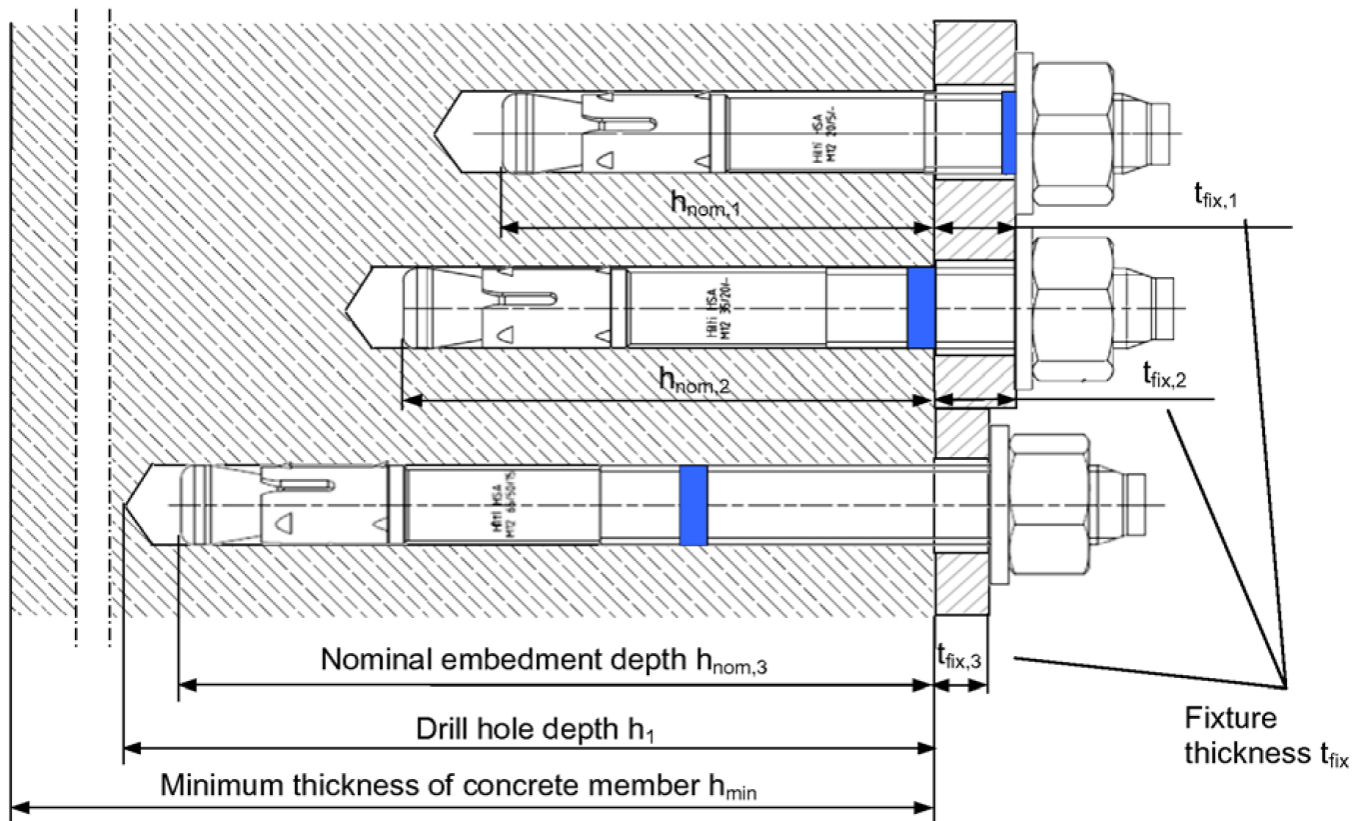

Setting details

Anchor size		M6		M8			M10		
Nominal anchorage depth	h_{nom} [mm]	37	47	39	49	79	50	60	90
Minimum base material thickness	h_{min} [mm]	100	100	100	100	120	100	120	160
Minimum spacing	s_{min} [mm]	35	35	85	85	85	100	100	100
Minimum edge distance	c_{min} [mm]	35	35	75	75	60	60	60	55
Nominal diameter of drill bit	d_o [mm]	6		8			10		
Cutting diameter of drill bit	$d_{cut} \leq$ [mm]	6,4		8,45			10,45		
Depth of drill hole	$h_1 \geq$ [mm]	42	52	44	54	84	55	65	95
Diameter of clearance hole in the fixture	$d_f \leq$ [mm]	7		9			12		
Torque moment	T_{inst} [Nm]	5		15			25		
Width across	SW [mm]	10		13			17		

Anchor size		M12			M16			M20		
Nominal anchorage depth	h_{nom} [mm]	64	79	114	77	92	132	90	115	130
Minimum base material thickness	h_{min} [mm]	100	140	180	140	160	180	160	220	220
Minimum spacing	s_{min} [mm]	100	100	100	190	190	190	200	200	200
Minimum edge distance	c_{min} [mm]	175	140	90	170	140	120	185	165	165
Nominal diameter of drill bit	d_o [mm]	12			16			20		
Cutting diameter of drill bit	$d_{cut} \leq$ [mm]	12,5			16,5			20,55		
Depth of drill hole	$h_1 \geq$ [mm]	72	87	122	85	100	140	98	123	138
Diameter of clearance hole in the fixture	$d_f \leq$ [mm]	14			18			22		
Torque moment	T_{inst} [Nm]	50			80			200		
Width across	SW [mm]	19			24			30		

Design parameters

Anchor size		M6		M8			M10		
Nominal anchorage depth	h_{nom} [mm]	37	47	39	49	79	50	60	90
Effective anchorage depth	h_{ef} [mm]	30	40	30	40	70	40	50	80
Critical spacing for splitting failure	$s_{cr,sp}$ [mm]	126	150	162	226	250	238	262	362
Critical edge distance for splitting failure	$c_{cr,sp}$ [mm]	63	75	81	113	125	119	131	181
Critical spacing for concrete cone failure	$s_{cr,N}$ [mm]	90	120	90	120	210	120	150	240
Critical edge distance for concrete cone failure	$c_{cr,N}$ [mm]	45	60	45	60	105	60	75	120

Anchor size		M12			M16			M20		
Nominal anchorage depth	h_{nom} [mm]	64	79	114	77	92	132	90	115	130
Effective anchorage depth	h_{ef} [mm]	50	65	100	65	80	120	75	100	115
Critical spacing for splitting failure	$s_{cr,sp}$ [mm]	250	312	388	288	350	476	326	462	500
Critical edge distance for splitting failure	$c_{cr,sp}$ [mm]	125	156	194	144	175	238	163	231	250
Critical spacing for concrete cone failure	$s_{cr,N}$ [mm]	150	195	300	195	240	360	225	300	345
Critical edge distance for concrete cone failure	$c_{cr,N}$ [mm]	75	97,5	150	97,5	120	180	112,5	150	172,5

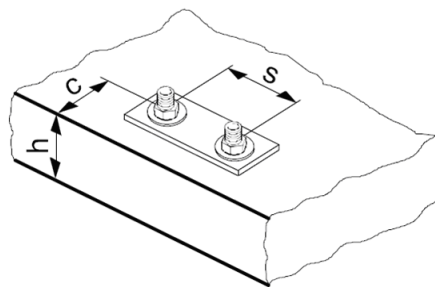

For spacing (edge distance) smaller than critical spacing (critical edge distance) the design loads have to be reduced.

Simplified design method

Simplified version of the design method according ETAG 001, Annex C. Design resistance according Hilti technical data.

- Influence of concrete strength
- Influence of edge distance
- Influence of spacing
- Valid for a group of two anchors. (The method may also be applied for anchor groups with more than two anchors or more than one edge. The influencing factors must then be considered for each edge distance and spacing. The calculated design loads are then conservative: They will be lower than the exact values according ETAG 001, Annex C. To avoid this, it is recommended to use the anchor design software PROFIS anchor)

The design method is based on the following simplification:

- No different loads are acting on individual anchors (no eccentricity)

The values are valid for one anchor.

For more complex fastening applications please use the anchor design software PROFIS Anchor.

Tension loading

The design tensile resistance is the lower value of

- Steel resistance: $N_{Rd,s}$
- Concrete pull-out resistance: $N_{Rd,p} = N_{Rd,p}^0$
- Concrete cone resistance: $N_{Rd,c} = N_{Rd,c}^0 \cdot f_B \cdot f_{1,N} \cdot f_{2,N} \cdot f_{3,N} \cdot f_{re,N}$
- Concrete splitting resistance: $N_{Rd,sp} = N_{Rd,c}^0 \cdot f_B \cdot f_{1,sp} \cdot f_{2,sp} \cdot f_{3,sp} \cdot f_{h,sp} \cdot f_{re,N}$

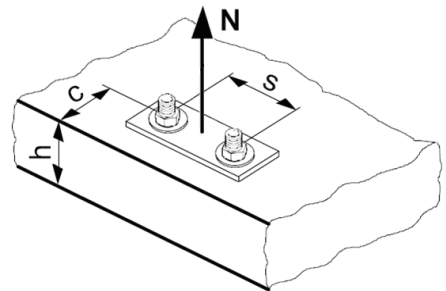

Basic design tensile resistance

Design steel resistance $N_{Rd,s}$

Anchor size	M6	M8	M10	M12	M16	M20
$N_{Rd,s}$ HSA-F [kN]	6,4	11,8	20,0	29,6	59,0	88,5

Design pull-out resistance $N_{Rd,p} = N_{Rd,p}^0$

Anchor size	M6			M8			M10			
Effective anchorage depth h_{ef} [mm]	30	40		30	40	70	40	50	80	
$N_{Rd,p}^0$ HSA-F [kN]	4,0	5,0		No pull-out			10,7	No pull-out	10,7	13,3

Anchor size	M12			M16			M20		
Effective anchorage depth h_{ef} [mm]	50	65	100	65	80	120	75	100	115
$N_{Rd,p}^0$ HSA-F [kN]	No pull-out	16,7	16,7	13,3	20,0	26,7	No pull-out		

Design concrete cone resistance $N_{Rd,c} = N_{Rd,c}^0 \cdot f_B \cdot f_{1,N} \cdot f_{2,N} \cdot f_{3,N} \cdot f_{re,N}$

Design splitting resistance ^{a)} $N_{Rd,sp} = N_{Rd,c}^0 \cdot f_B \cdot f_{1,sp} \cdot f_{2,sp} \cdot f_{3,sp} \cdot f_{h,sp} \cdot f_{re,N}$

Anchor size			M6		M8			M10		
Effective anchorage depth	h_{ef}	[mm]	30	40	30	40	70	40	50	80
$N_{Rd,p}^0$	HSA-F	[kN]	5,5	8,5	5,5	8,5	19,7	8,5	11,9	24,1

Anchor size			M12			M16			M20		
Effective anchorage depth	h_{ef}	[mm]	50	65	100	65	80	120	75	100	115
$N_{Rd,p}^0$	HSA-F	[kN]	11,9	17,6	33,7	17,6	24,1	44,3	21,9	33,7	41,5

Influencing factors

Influence of concrete strength

Concrete strength designation (ENV 206)	C 20/25	C 25/30	C 30/37	C 35/45	C 40/50	C 45/55	C 50/60
Pull-out, concrete cone and splitting resistance							
$f_B = (f_{ck,cube}/25N/mm^2)^{1/2}$ ^{a)}	1	1,1	1,22	1,34	1,41	1,48	1,55

a) $f_{ck,cube}$ = concrete compressive strength, measured on cubes with 150 mm side length

Influence of edge distance ^{a)}

$c/c_{cr,N}$	0,1	0,2	0,3	0,4	0,5	0,6	0,7	0,8	0,9	1
$c/c_{cr,sp}$										
$f_{1,N} = 0,7 + 0,3 \cdot c/c_{cr,N} \leq 1$	0,73	0,76	0,79	0,82	0,85	0,88	0,91	0,94	0,97	1
$f_{1,sp} = 0,7 + 0,3 \cdot c/c_{cr,sp} \leq 1$										
$f_{2,N} = 0,5 \cdot (1 + c/c_{cr,N}) \leq 1$	0,55	0,60	0,65	0,70	0,75	0,80	0,85	0,90	0,95	1
$f_{2,sp} = 0,5 \cdot (1 + c/c_{cr,sp}) \leq 1$										

a) The edge distance shall not be smaller than the minimum edge distance c_{min} given in the table with the setting details. These influencing factors must be considered for every edge distance.

Influence of anchor spacing ^{a)}

$s/s_{cr,N}$	0,1	0,2	0,3	0,4	0,5	0,6	0,7	0,8	0,9	1
$s/s_{cr,sp}$										
$f_{3,N} = 0,5 \cdot (1 + s/s_{cr,N}) \leq 1$	0,55	0,60	0,65	0,70	0,75	0,80	0,85	0,90	0,95	1
$f_{3,sp} = 0,5 \cdot (1 + s/s_{cr,sp}) \leq 1$										

a) The anchor spacing shall not be smaller than the minimum anchor spacing s_{min} given in the table with the setting details. This influencing factor must be considered for every anchor spacing.

Influence of base material thickness

h/h_{min}	1,0	1,1	1,2	1,3	1,4	1,5	1,6	1,7	1,8	$\geq 1,84$
$f_{h,sp} = [h/(h_{min})]^{2/3}$	1	1,07	1,13	1,19	1,25	1,31	1,37	1,42	1,48	1,5

Influence of reinforcement ^{a)}

Anchor size	M6			M8			M10		
Effective anchorage depth h_{ef} [mm]	30	40		30	40	70	40	50	80
$f_{re,N} = 0,5 + h_{ef}/200\text{mm} \leq 1$	0,65	0,7		0,65	0,7	0,85	0,7	0,75	0,9

Anchor size	M12			M16			M20		
Effective anchorage depth h_{ef} [mm]	50	65	100	65	80	120	75	100	115
$f_{re,N} = 0,5 + h_{ef}/200\text{mm} \leq 1$	0,75	0,83	1	0,83	0,9	1	0,88	1	1

b) This factor applies only for dense reinforcement. If in the area of anchorage there is reinforcement with a spacing ≥ 150 mm (any diameter) or with a diameter ≤ 10 mm and a spacing ≥ 100 mm, then a factor $f_{re,N} = 1$ may be applied.

Shear loading

The design shear resistance is the lower value of

- Steel resistance: $V_{Rd,s}$
- Concrete pryout resistance: $V_{Rd,cp} = k \cdot N_{Rd,c}$
- Concrete edge resistance: $V_{Rd,c} = V_{Rd,c}^0 \cdot f_B \cdot f_{\beta} \cdot f_h \cdot f_4 \cdot f_{hef} \cdot f_c$

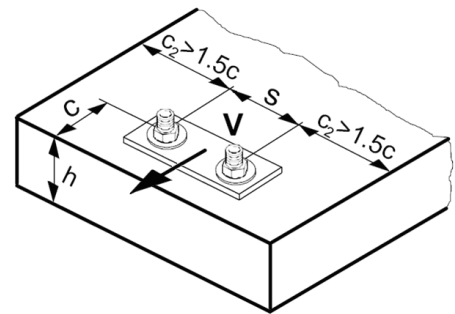

Basic design shear resistance

Design steel resistance $V_{Rd,s}$

Anchor size	M6	M8	M10	M12	M16	M20
$V_{Rd,s}$ HSA-F [kN]	5,2	8,5	15,1	23,6	40,8	68,6

Design concrete pryout resistance $V_{Rd,cp} = k \cdot N_{Rd,c}$ ^{a)}

Anchor size	M6			M8			M10		
Effective anchorage depth h_{ef} [mm]	30	40		30	40	70	40	50	80
k	1	1		1	1,5	2	2,4	2,4	2,4

Anchor size	M12			M16			M20		
Effective anchorage depth h_{ef} [mm]	50	65	100	65	80	120	75	100	115
k	2	2	2	2,9	2,9	2,9	2	3,5	3,5

a) $N_{Rd,c}$: Design concrete cone resistance

Design concrete edge resistance $a) V_{Rd,c} = V_{Rd,c}^0 \cdot f_B \cdot f_{\beta} \cdot f_h \cdot f_4 \cdot f_{hef} \cdot f_c$

Anchor size	M6			M8			M10		
Effective anchorage depth h_{ef} [mm]	30	40		30	40	70	40	50	80
$V_{Rd,c}^0$ [kN]	3,6	3,6		5,8	5,9	6,0	8,5	8,5	8,6

Anchor size	M12			M16			M20		
Effective anchorage depth h_{ef} [mm]	50	65	100	65	80	120	75	100	115
$V_{Rd,c}^0$ [kN]	11,6	11,6	11,7	18,7	18,8	18,9	27,2	27,3	27,4

b) For anchor groups only the anchors close to the edge must be considered.

Influencing factors

Influence of concrete strength

Concrete strength designation (ENV 206)	C 20/25	C 25/30	C 30/37	C 35/45	C 40/50	C 45/55	C 50/60
$f_B = (f_{ck,cube}/25N/mm^2)^{1/2}$ a)	1	1,1	1,22	1,34	1,41	1,48	1,55

a) $f_{ck,cube}$ = concrete compressive strength, measured on cubes with 150 mm side length

Influence of angle between load applied and the direction perpendicular to the free edge

Angle β	0°	10°	20°	30°	40°	50°	60°	70°	80°	≥ 90°
$f_{\beta} = \frac{1}{\sqrt{(\cos \alpha_V)^2 + \left(\frac{\sin \alpha_V}{2,5}\right)^2}}$	1	1,01	1,05	1,13	1,24	1,40	1,64	1,97	2,32	2,50

Influence of base material thickness

h/c	0,15	0,3	0,45	0,6	0,75	0,9	1,05	1,2	1,35	≥ 1,5
$f_h = \{h/(1,5 \cdot c)\}^{1/2} \leq 1$	0,32	0,45	0,55	0,63	0,71	0,77	0,84	0,89	0,95	1,00

Influence of anchor spacing and edge distance ^{a)} for concrete edge resistance: f_4

$$f_4 = (c/h_{ef})^{1,5} \cdot (1 + s / [3 \cdot c]) \cdot 0,5$$

c/h _{ef}	Single anchor	Group of two anchors s/h _{ef}														
		0,75	1,50	2,25	3,00	3,75	4,50	5,25	6,00	6,75	7,50	8,25	9,00	9,75	10,50	11,25
0,50	0,35	0,27	0,35	0,35	0,35	0,35	0,35	0,35	0,35	0,35	0,35	0,35	0,35	0,35	0,35	0,35
0,75	0,65	0,43	0,54	0,65	0,65	0,65	0,65	0,65	0,65	0,65	0,65	0,65	0,65	0,65	0,65	0,65
1,00	1,00	0,63	0,75	0,88	1,00	1,00	1,00	1,00	1,00	1,00	1,00	1,00	1,00	1,00	1,00	1,00
1,25	1,40	0,84	0,98	1,12	1,26	1,40	1,40	1,40	1,40	1,40	1,40	1,40	1,40	1,40	1,40	1,40
1,50	1,84	1,07	1,22	1,38	1,53	1,68	1,84	1,84	1,84	1,84	1,84	1,84	1,84	1,84	1,84	1,84
1,75	2,32	1,32	1,49	1,65	1,82	1,98	2,15	2,32	2,32	2,32	2,32	2,32	2,32	2,32	2,32	2,32
2,00	2,83	1,59	1,77	1,94	2,12	2,30	2,47	2,65	2,83	2,83	2,83	2,83	2,83	2,83	2,83	2,83
2,25	3,38	1,88	2,06	2,25	2,44	2,63	2,81	3,00	3,19	3,38	3,38	3,38	3,38	3,38	3,38	3,38
2,50	3,95	2,17	2,37	2,57	2,77	2,96	3,16	3,36	3,56	3,76	3,95	3,95	3,95	3,95	3,95	3,95
2,75	4,56	2,49	2,69	2,90	3,11	3,32	3,52	3,73	3,94	4,15	4,35	4,56	4,56	4,56	4,56	4,56
3,00	5,20	2,81	3,03	3,25	3,46	3,68	3,90	4,11	4,33	4,55	4,76	4,98	5,20	5,20	5,20	5,20
3,25	5,86	3,15	3,38	3,61	3,83	4,06	4,28	4,51	4,73	4,96	5,18	5,41	5,63	5,86	5,86	5,86
3,50	6,55	3,51	3,74	3,98	4,21	4,44	4,68	4,91	5,14	5,38	5,61	5,85	6,08	6,31	6,55	6,55
3,75	7,26	3,87	4,12	4,36	4,60	4,84	5,08	5,33	5,57	5,81	6,05	6,29	6,54	6,78	7,02	7,26
4,00	8,00	4,25	4,50	4,75	5,00	5,25	5,50	5,75	6,00	6,25	6,50	6,75	7,00	7,25	7,50	7,75
4,25	8,76	4,64	4,90	5,15	5,41	5,67	5,93	6,18	6,44	6,70	6,96	7,22	7,47	7,73	7,99	8,25
4,50	9,55	5,04	5,30	5,57	5,83	6,10	6,36	6,63	6,89	7,16	7,42	7,69	7,95	8,22	8,49	8,75
4,75	10,35	5,45	5,72	5,99	6,27	6,54	6,81	7,08	7,36	7,63	7,90	8,17	8,45	8,72	8,99	9,26
5,00	11,18	5,87	6,15	6,43	6,71	6,99	7,27	7,55	7,83	8,11	8,39	8,66	8,94	9,22	9,50	9,78
5,25	12,03	6,30	6,59	6,87	7,16	7,45	7,73	8,02	8,31	8,59	8,88	9,17	9,45	9,74	10,02	10,31
5,50	12,90	6,74	7,04	7,33	7,62	7,92	8,21	8,50	8,79	9,09	9,38	9,67	9,97	10,26	10,55	10,85

a) The anchor spacing and the edge distance shall not be smaller than the minimum anchor spacing s_{min} and the minimum edge distance c_{min} .

Influence of embedment depth

Anchor size	M6		M8			M10		
Effective anchorage depth h_{ef} [mm]	30	40	30	40	70	40	50	80
$f_{hef} = 0,05 \cdot (h_{ef} / d)^{1,68}$	0,75	1,21	0,46	0,75	1,91	0,51	0,75	1,64

Anchor size	M12			M16			M20		
Effective anchorage depth h_{ef} [mm]	50	65	100	65	80	120	75	100	115
$f_{hef} = 0,05 \cdot (h_{ef} / d)^{1,68}$	0,55	0,85	1,76	0,53	0,75	1,48	0,46	0,75	0,94

Influence of edge distance ^{a)}



c/d	4	6	8	10	15	20	30	40
$f_c = (d / c)^{0,19}$	0,77	0,71	0,67	0,65	0,60	0,57	0,52	0,50

a) The edge distance shall not be smaller than the minimum edge distance c_{min} .

Combined tension and shear loading

For combined tension and shear loading see section "Anchor Design".

HSV Stud anchor

	Anchor versions	Benefits
	HSV Carbon steel with DIN 125 washer	<ul style="list-style-type: none"> - torque-controlled mechanical expansion allows immediate load application - setting mark - cold-formed to prevent breaking during installation - raised impact section prevents thread damage during installation - drill bit size is same as anchor size for easy installation.
	HSV-BW Carbon steel with DIN 9021 washer and DIN 127b spring washer	



Concrete

Basic loading data (for a single anchor)

All data in this section applies to

- Correct setting (See setting instruction)
- No edge distance and spacing influence
- Concrete as specified in the table
- Steel failure
- Minimum base material thickness
- Concrete C 20/25, $f_{ck,cube} = 25 \text{ N/mm}^2$

Mean ultimate resistance

Anchor size	M8		M10		M12		M16	
Effective anchorage depth $h_{ef} \geq$ [mm]	30	40	40	50	50	65	65	80
Tensile $N_{Ru,m}$ [kN]	11,0	15,9	15,9	18,6	19,2	26,6	35,1	48,0
Shear $V_{Ru,m}$ [kN]	8,9	8,9	15,1	15,1	23,7	23,7	44,5	44,5

Characteristic resistance

Anchor size	M8		M10		M12		M16	
Effective anchorage depth $h_{ef} \geq$ [mm]	30	40	40	50	50	65	65	80
Tensile N_{Rk} [kN]	8,3	12,0	12,0	14,0	14,5	20,0	26,5	36,1
Shear V_{Rk} [kN]	8,3	8,5	12,8	14,4	17,9	22,6	42,4	42,4

Design resistance

Anchor size	M8		M10		M12		M16	
Effective anchorage depth $h_{ef} \geq$ [mm]	30	40	40	50	50	65	65	80
Tensile N_{Rd} [kN]	4,6	6,7	8,0	9,3	9,7	13,3	14,7	20,1
Shear V_{Rd} [kN]	5,5	6,8	8,5	11,5	11,9	18,1	33,9	33,9

Recommended loads

Anchor size	M8		M10		M12		M16	
Effective anchorage depth $h_{ef} \geq$ [mm]	30	40	40	50	50	65	65	80
Tensile $N_{rec}^{a)}$ [kN]	3,3	4,8	5,7	6,7	6,9	9,5	10,5	14,3
Shear $V_{rec}^{a)}$ [kN]	4,0	4,9	6,1	8,2	8,5	12,9	24,2	24,2

a) With overall partial safety factor for action $\gamma = 1,4$. The partial safety factors for action depend on the type of loading and shall be taken from national regulations.

Materials

Mechanical properties of HSV

Anchor size	M8		M10		M12		M16	
Nominal tensile strength f_{uk} [N/mm ²]	580		660		660		660	
Yield strength f_{yk} [N/mm ²]	464		528		528		528	
Stressed cross-section, thread A_s [mm ²]	36,6		58,0		84,3		157	
Stressed cross-section, neck $A_{s,neck}$ [mm ²]	26,9		39,6		63,6		105,7	
Moment of resistance W [mm ³]	31,2		62,3		109,2		277,5	
Char. bending resistance $M^0_{Rk,s}$ [Nm]	19,5		41,1		72,1		166,5	

Material quality

Part	Material
Bolt	Carbon steel, galvanised to min. 5 μ m

Anchor dimensions

Anchor size			M8	M10	M12	M16
Shaft diameter at the cone	d_R	[mm]	5,85	7,1	9	11,6
Maximum length of the anchor	l_1	[mm]	75	100	150	140
Length of expansion sleeve	l_2	[mm]	15	17,6	20,6	24

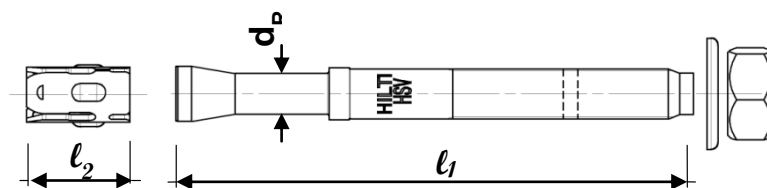

Setting

Installation equipment

Anchor size	M8	M10	M12	M16
Rotary hammer	TE1 – TE30			
Other tools	blow out pump, hammer, torque wrench			

Setting instruction

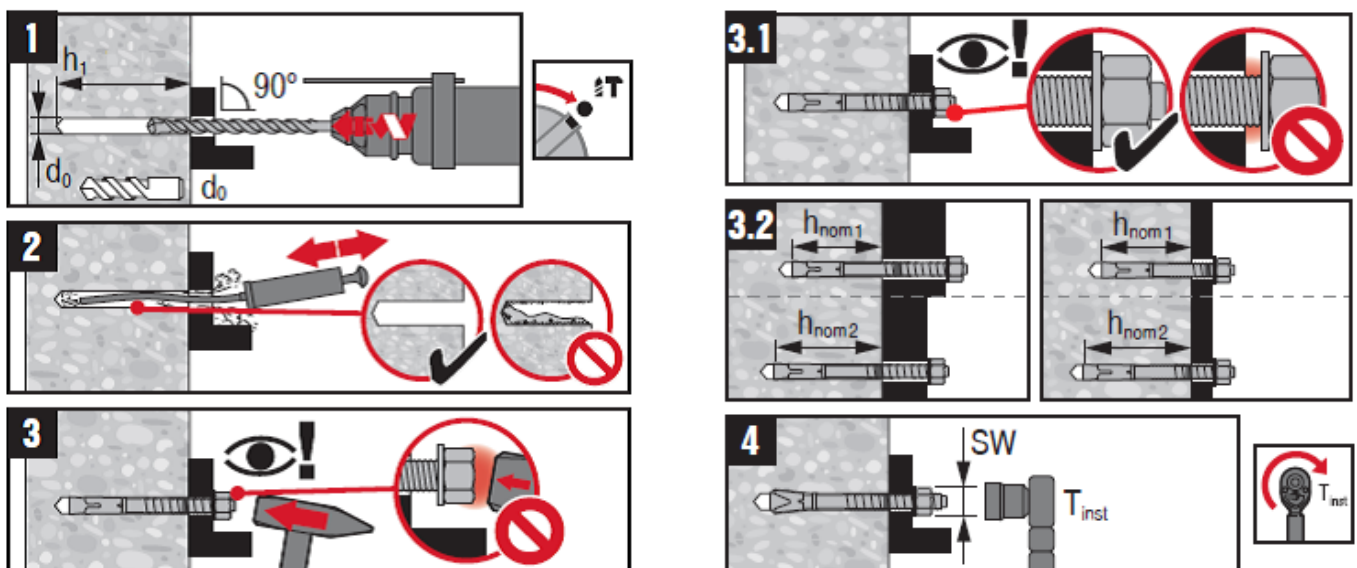

For detailed information on installation see instruction for use given with the package of the product.

Setting details

Anchor size		M8		M10		M12		M16	
Effective anchorage depth	h_{ef} [mm]	30	40	40	50	50	65	65	80
Nominal embedment depth	h_{nom} [mm]	39	49	51	61	62	77	81	96
Nominal Diameter of drill bit	d_0 [mm]	8		10		12		16	
Cutting diameter of drill bit	$d_{cut} \leq$ [mm]	8,45		10,45		12,5		16,5	
Depth of drill hole	$h_1 \geq$ [mm]	45	55	60	70	70	85	90	105
Diameter of clearance hole in the fixture	$d_f \leq$ [mm]	9		12		14		18	
Minimum thickness of fixture ^{a)}	$t_{fix,min}$ [mm]	5	0	5	0	5	0	5	0
Maximum thickness of fixture ^{a)}	$t_{fix,max}$ [mm]	20	10	35	25	70	55	35	20
Torque moment	T_{inst} [Nm]	15		30		50		100	
Width across nut flats	SW [mm]	13		17		19		24	

a) The values are only valid for HSV with standard washer. For HSV-BW with DIN 9021 washer and DIN 127b spring washer the thickness of the fixture has to be reduced.

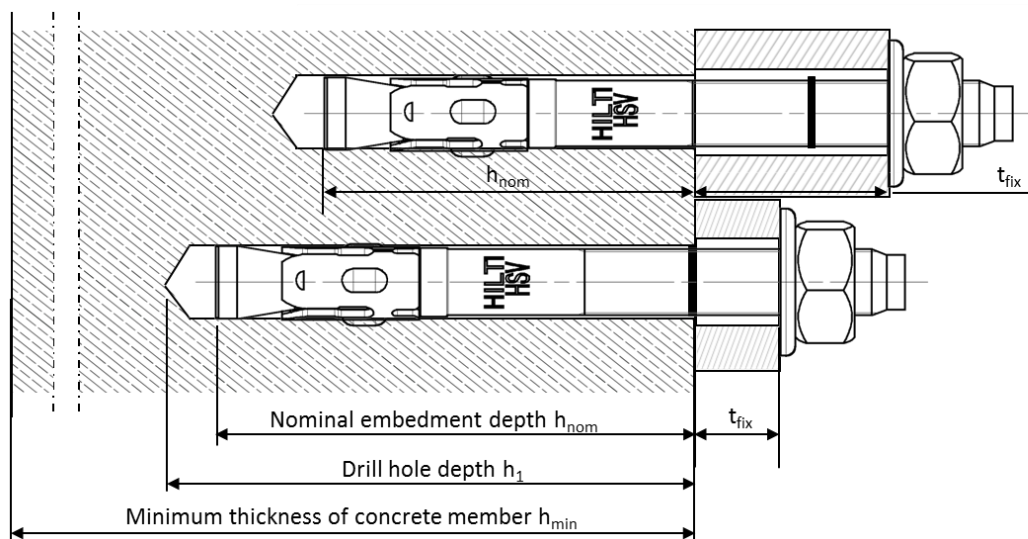

Setting parameters ^{a)}

Anchor size		M8		M10		M12		M16	
Effective anchorage depth	h_{ef} [mm]	30	40	40	50	50	65	65	80
Minimum base material thickness	$h_{min} \geq$ [mm]	100	100	100	120	140	140	130	170
Minimum spacing	$s_{min} \geq$ [mm]	60	60	70	70	80	80	120	100
Minimum edge distance	$c_{min} \geq$ [mm]	60	60	70	70	90	90	120	100
Critical spacing for splitting failure	$s_{cr,sp}$ [mm]	180	240	240	300	300	390	390	480
Critical edge distance for splitting failure	$c_{cr,sp}$ [mm]	90	120	120	150	150	195	195	240
Critical spacing for concrete cone failure	$s_{cr,N}$ [mm]	90	120	120	150	150	195	195	240
Critical edge distance for concrete cone failure	$c_{cr,N}$ [mm]	45	60	60	75	75	97,5	97,5	120

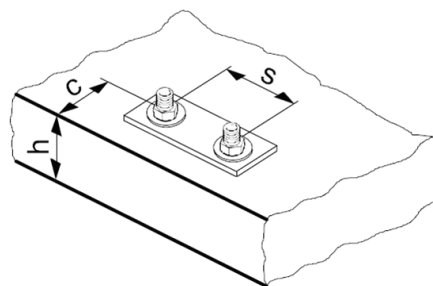

c) In case of smaller edge distance and spacing than $c_{cr,sp}$, $s_{cr,sp}$, $c_{cr,N}$ and $s_{cr,N}$ the load values shall be reduced according ETAG 001, Annex C

Simplified design method

Simplified version of the design method according ETAG 001, Annex C.

- Influence of concrete strength
- Influence of edge distance
- Influence of spacing
- Valid for a group of two anchors. The method may also be applied for anchor groups with more than two anchors or more than one edge. The influencing factors must then be considered for each edge distance and spacing. The calculated design loads are then on the save side: They will be lower than the exact values according ETAG 001, Annex C.

The design method is based on the following simplification:

- No different loads are acting on individual anchors (no eccentricity)

The values are valid for one anchor.

Tension loading

The design tensile resistance is the lower value of

- Steel resistance: $N_{Rd,s}$
- Concrete pull-out resistance: $N_{Rd,p} = N_{Rd,p}^0 \cdot f_B$
- Concrete cone resistance: $N_{Rd,c} = N_{Rd,c}^0 \cdot f_B \cdot f_{1,N} \cdot f_{2,N} \cdot f_{3,N} \cdot f_{re,N}$
- Concrete splitting resistance (only non-cracked concrete):
 $N_{Rd,sp} = N_{Rd,c}^0 \cdot f_B \cdot f_{1,sp} \cdot f_{2,sp} \cdot f_{3,sp} \cdot f_{h,sp} \cdot f_{re,N}$

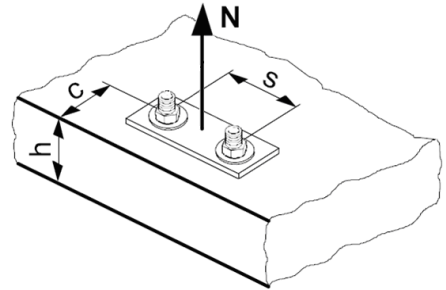

Basic design tensile resistance

Design steel resistance $N_{Rd,s}$

Anchor size	M8		M10		M12		M16	
Effective anchorage depth h_{ef} [mm]	30	40	40	50	50	65	65	80
$N_{Rd,s}$ [kN]	10,4		17,4		28,0		46,5	

Design pull-out resistance $N_{Rd,p} = N_{Rd,p}^0 \cdot f_B$

Anchor size	M8		M10		M12		M16	
Effective anchorage depth h_{ef} [mm]	30	40	40	50	50	65	65	80
$N_{Rd,p}^0$ [kN]	6,7	6,7	8,0	9,3	9,7	13,3	16,6	20,8

Design concrete cone resistance $N_{Rd,c} = N_{Rd,c}^0 \cdot f_B \cdot f_{1,N} \cdot f_{2,N} \cdot f_{3,N} \cdot f_{re,N}$

Design splitting resistance ^{a)} $N_{Rd,sp} = N_{Rd,c}^0 \cdot f_B \cdot f_{1,sp} \cdot f_{2,sp} \cdot f_{3,sp} \cdot f_{h,sp} \cdot f_{re,N}$

Anchor size	M8		M10		M12		M16	
Effective anchorage depth h_{ef} [mm]	30	40	40	50	50	65	65	80
$N_{Rd,c}^0$ [kN]	4,6	7,1	8,5	11,9	11,9	17,6	14,7	20,1

Influencing factors

Influence of concrete strength

Concrete strength designation (ENV 206)	C 20/25	C 25/30	C 30/37	C 35/45	C 40/50	C 45/55	C 50/60
Pull-out resistance							
$f_B =$	1						
Concrete cone and splitting resistance							
$f_B = (f_{ck,cube}/25N/mm^2)^{1/2}$ ^{a)}	1	1,1	1,22	1,34	1,41	1,48	1,55

a) $f_{ck,cube}$ = concrete compressive strength, measured on cubes with 150 mm side length

Influence of edge distance ^{a)}

$c/c_{cr,N}$	0,1	0,2	0,3	0,4	0,5	0,6	0,7	0,8	0,9	1
$c/c_{cr,sp}$										
$f_{1,N} = 0,7 + 0,3 \cdot c/c_{cr,N} \leq 1$	0,73	0,76	0,79	0,82	0,85	0,88	0,91	0,94	0,97	1
$f_{1,sp} = 0,7 + 0,3 \cdot c/c_{cr,sp} \leq 1$										
$f_{2,N} = 0,5 \cdot (1 + c/c_{cr,N}) \leq 1$	0,55	0,60	0,65	0,70	0,75	0,80	0,85	0,90	0,95	1
$f_{2,sp} = 0,5 \cdot (1 + c/c_{cr,sp}) \leq 1$										

a) The edge distance shall not be smaller than the minimum edge distance c_{min} given in the table with the setting details. These influencing factors must be considered for every edge distance.

Influence of anchor spacing ^{a)}

$s/s_{cr,N}$	0,1	0,2	0,3	0,4	0,5	0,6	0,7	0,8	0,9	1
$s/s_{cr,sp}$										
$f_{3,N} = 0,5 \cdot (1 + s/s_{cr,N}) \leq 1$	0,55	0,60	0,65	0,70	0,75	0,80	0,85	0,90	0,95	1
$f_{3,sp} = 0,5 \cdot (1 + s/s_{cr,sp}) \leq 1$										

a) The anchor spacing shall not be smaller than the minimum anchor spacing s_{min} given in the table with the setting details. This influencing factor must be considered for every anchor spacing.

Influence of base material thickness

h/h_{ef}	2,0	2,2	2,4	2,6	2,8	3,0	3,2	3,4	3,6	$\geq 3,68$
$f_{h,sp} = [h/(2 \cdot h_{ef})]^{2/3}$	1	1,07	1,13	1,19	1,25	1,31	1,37	1,42	1,48	1,5

Influence of reinforcement

Anchor size	M8		M10		M12		M16	
Effective anchorage depth h_{ef} [mm]	30	40	40	50	50	65	65	80
$f_{re,N} = 0,5 + h_{ef}/200mm \leq 1$	0,65 ^{a)}	0,7 ^{a)}	0,7 ^{a)}	0,75 ^{a)}	0,75 ^{a)}	0,825 ^{a)}	0,825 ^{a)}	0,9 ^{a)}

c) This factor applies only for dense reinforcement. If in the area of anchorage there is reinforcement with a spacing ≥ 150 mm (any diameter) or with a diameter ≤ 10 mm and a spacing ≥ 100 mm, then a factor $f_{re,N} = 1$ may be applied.

Shear loading

The design shear resistance is the lower value of

- Steel resistance: $V_{Rd,s}$
- Concrete pryout resistance: $V_{Rd,cp} = k \cdot N_{Rd,c}$
- Concrete edge resistance: $V_{Rd,c} = V_{Rd,c}^0 \cdot f_B \cdot f_h \cdot f_4 \cdot f_{hef} \cdot f_c$

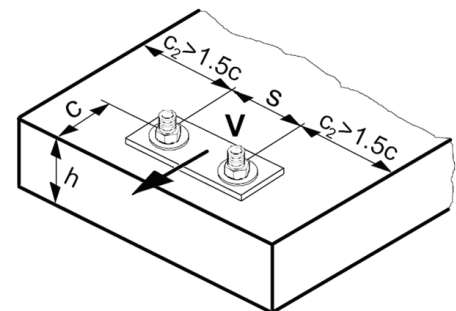

Basic design shear resistance

Design steel resistance $V_{Rd,s}$

Anchor size	M8		M10		M12		M16	
Effective anchorage depth h_{ef} [mm]	30	40	40	50	50	65	65	80
$V_{Rd,s}$ [kN]	6,8		11,5		18,1		33,9	

Design concrete pryout resistance $V_{Rd,cp} = k \cdot N_{Rd,c}^{a)}$

Anchor size	M8		M10		M12		M16		
Effective anchorage depth h_{ef} [mm]	30	40	40	50	50	65	65	80	
k	1					2			

a) $N_{Rd,c}$: Design concrete cone resistance

Design concrete edge resistance $^a)V_{Rd,c} = V_{Rd,c}^0 \cdot f_B \cdot f_{\beta} \cdot f_h \cdot f_4 \cdot f_{hef} \cdot f_c$

Anchor size	M8		M10		M12		M16	
Effective anchorage depth h_{ef} [mm]	30	40	40	50	50	65	65	80
$V_{Rd,c}^0$ [kN]	9,1	9,0	13,0	13,0	17,6	17,6	28,3	28,2

a) For anchor groups only the anchors close to the edge must be considered.

Influencing factors

Influence of concrete strength

Concrete strength designation (ENV 206)	C 20/25	C 25/30	C 30/37	C 35/45	C 40/50	C 45/55	C 50/60
$f_B = (f_{ck,cube}/25N/mm^2)^{1/2}$ a)	1	1,1	1,22	1,34	1,41	1,48	1,55

a) $f_{ck,cube}$ = concrete compressive strength, measured on cubes with 150 mm side length

Influence of angle between load applied and the direction perpendicular to the free edge

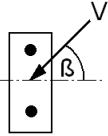
Angle β	0°	10°	20°	30°	40°	50°	60°	70°	80°	≥ 90°
$f_{\beta} = \sqrt{\frac{1}{(\cos \alpha_V)^2 + \left(\frac{\sin \alpha_V}{2,5}\right)^2}}$ 	1	1,01	1,05	1,13	1,24	1,40	1,64	1,97	2,32	2,50

Influence of base material thickness

h/c	0,15	0,3	0,45	0,6	0,75	0,9	1,05	1,2	1,35	≥ 1,5
$f_h = \{h/(1,5 \cdot c)\}^{1/2} \leq 1$	0,32	0,45	0,55	0,63	0,71	0,77	0,84	0,89	0,95	1,00

Influence of anchor spacing and edge distance ^{a)} for concrete edge resistance: f_4
 $f_4 = (c/h_{ef})^{1,5} \cdot (1 + s / [3 \cdot c]) \cdot 0,5$

c/h _{ef}	Single anchor	Group of two anchors s/h _{ef}														
		0,75	1,50	2,25	3,00	3,75	4,50	5,25	6,00	6,75	7,50	8,25	9,00	9,75	10,50	11,25
0,50	0,35	0,27	0,35	0,35	0,35	0,35	0,35	0,35	0,35	0,35	0,35	0,35	0,35	0,35	0,35	0,35
0,75	0,65	0,43	0,54	0,65	0,65	0,65	0,65	0,65	0,65	0,65	0,65	0,65	0,65	0,65	0,65	0,65
1,00	1,00	0,63	0,75	0,88	1,00	1,00	1,00	1,00	1,00	1,00	1,00	1,00	1,00	1,00	1,00	1,00
1,25	1,40	0,84	0,98	1,12	1,26	1,40	1,40	1,40	1,40	1,40	1,40	1,40	1,40	1,40	1,40	1,40
1,50	1,84	1,07	1,22	1,38	1,53	1,68	1,84	1,84	1,84	1,84	1,84	1,84	1,84	1,84	1,84	1,84
1,75	2,32	1,32	1,49	1,65	1,82	1,98	2,15	2,32	2,32	2,32	2,32	2,32	2,32	2,32	2,32	2,32
2,00	2,83	1,59	1,77	1,94	2,12	2,30	2,47	2,65	2,83	2,83	2,83	2,83	2,83	2,83	2,83	2,83
2,25	3,38	1,88	2,06	2,25	2,44	2,63	2,81	3,00	3,19	3,38	3,38	3,38	3,38	3,38	3,38	3,38
2,50	3,95	2,17	2,37	2,57	2,77	2,96	3,16	3,36	3,56	3,76	3,95	3,95	3,95	3,95	3,95	3,95
2,75	4,56	2,49	2,69	2,90	3,11	3,32	3,52	3,73	3,94	4,15	4,35	4,56	4,56	4,56	4,56	4,56
3,00	5,20	2,81	3,03	3,25	3,46	3,68	3,90	4,11	4,33	4,55	4,76	4,98	5,20	5,20	5,20	5,20
3,25	5,86	3,15	3,38	3,61	3,83	4,06	4,28	4,51	4,73	4,96	5,18	5,41	5,63	5,86	5,86	5,86
3,50	6,55	3,51	3,74	3,98	4,21	4,44	4,68	4,91	5,14	5,38	5,61	5,85	6,08	6,31	6,55	6,55
3,75	7,26	3,87	4,12	4,36	4,60	4,84	5,08	5,33	5,57	5,81	6,05	6,29	6,54	6,78	7,02	7,26
4,00	8,00	4,25	4,50	4,75	5,00	5,25	5,50	5,75	6,00	6,25	6,50	6,75	7,00	7,25	7,50	7,75
4,25	8,76	4,64	4,90	5,15	5,41	5,67	5,93	6,18	6,44	6,70	6,96	7,22	7,47	7,73	7,99	8,25
4,50	9,55	5,04	5,30	5,57	5,83	6,10	6,36	6,63	6,89	7,16	7,42	7,69	7,95	8,22	8,49	8,75
4,75	10,35	5,45	5,72	5,99	6,27	6,54	6,81	7,08	7,36	7,63	7,90	8,17	8,45	8,72	8,99	9,26
5,00	11,18	5,87	6,15	6,43	6,71	6,99	7,27	7,55	7,83	8,11	8,39	8,66	8,94	9,22	9,50	9,78
5,25	12,03	6,30	6,59	6,87	7,16	7,45	7,73	8,02	8,31	8,59	8,88	9,17	9,45	9,74	10,02	10,31
5,50	12,90	6,74	7,04	7,33	7,62	7,92	8,21	8,50	8,79	9,09	9,38	9,67	9,97	10,26	10,55	10,85

a) The anchor spacing and the edge distance shall not be smaller than the minimum anchor spacing s_{min} and the minimum edge distance c_{min} .

Influence of embedment depth

Anchor size	M8		M10		M12		M16	
Effective anchorage depth h_{ef} [mm]	30	40	40	50	50	65	65	80
$f_{hef} = 0,05 \cdot (h_{ef} / d)^{1,68}$	0,46	0,75	0,51	0,75	0,55	0,85	0,53	0,75

Influence of edge distance ^{a)}







c/d	4	6	8	10	15	20	30	40
$f_c = (d / c)^{0,19}$	0,77	0,71	0,67	0,65	0,60	0,57	0,52	0,50

a) The edge distance shall not be smaller than the minimum edge distance c_{min} .

Combined tension and shear loading

For combined tension and shear loading see section "Anchor Design".

HLC Sleeve anchor

Anchor version		Benefits
	HLC Hex head nut with pressed-on washer	HLC offers various head shapes and fastening thicknesses.
	HLC-H Bolt version with washer	
	HLC-L Torx round head	
	HLC-SK Torx Counter sunk head	
	HLC-EC Loop-hanger head, eyebolt closed	
	HLC-EO Loop-hanger head, eyebolt open	
	HLC-T Ceiling hanger	



Concrete

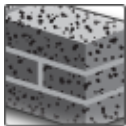

Solid brick



Fire resistance

Approvals / certificates

Description	Authority / Laboratory	No. / date of issue
Fire test report	IBMB, Braunschweig	PB 3093/517/07-CM / 2007-09-10
Assessment report (fire)	warringtonfire	WF 327804/A / 2013-07-10

Basic loading data (for a single anchor)

All data in this section applies to

- Correct setting (See setting instruction)
- No edge distance and spacing influence
- Concrete as specified in the table
- Steel failure
- Minimum base material thickness
- Concrete C 20/25, $f_{ck,cube} = 25 \text{ N/mm}^2$

Characteristic resistance

Anchor size		6,5	8	10	12	16	20
Tensile N_{Rk}	[kN]	2,1	3,5	4,5	7,2	10,0	13,2
Shear V_{Rk}	[kN]	3,2	7,0	8,8	14,4	20,0	20,0

Design resistance

Anchor size		6,5	8	10	12	16	20
Tensile N_{Rd}	[kN]	1,2	2,0	2,5	4,0	5,6	7,4
Tensile N_{Rd}	[kN]	1,8	3,9	4,9	8,0	11,1	11,1

Recommended loads

Anchor size		6,5	8	10	12	16	20
Tensile $N_{rec}^{a)}$	[kN]	0,8	1,4	1,8	2,9	4,0	5,3
Shear $V_{rec}^{a)}$	[kN]	1,3	2,8	3,5	5,7	7,9	7,9

a) With overall partial safety factor for action $\gamma = 1,4$. The partial safety factors for action depend on the type of loading and shall be taken from national regulations.

Materials

Material quality

Part		Material
Anchor	HLC HLC-EC HLC-EO	Carbon steel minimum tensile strength 500 MPa galvanised to min. 5 μ m
	HLC-H HLC-L HLC-SK HLC-T	Steel Bolt Strength 8.8, galvanised to min. 5 μ m

Anchor dimensions

Anchor version	Thread size	h_{ef} [mm]	d [mm]	l [mm]	l_c [mm]	t_{fix} [mm]
HLC, HLC-H, HLC-EC/EO carbon steel anchors	6,5 x 25/5	16	M5	30	25	5
	6,5 x 40/20			45	40	20
	6,5 x 60/40			65	60	40
	8 x 40/10	26	M6	46	40	10
	8 x 55/25			61	55	25
	8 x 70/40			76	70	40
	8 x 85/55			91	85	55
	10 x 40/5	31	M8	48	40	5
	10 x 50/15			58	50	15
	10 x 60/25			68	60	25
	10 x 80/45			88	80	45
	10 x 100/65			108	100	65
	12 x 55/15	33	M10	65	55	15
	12 x 75/35			85	75	35
	12 x 100/60			110	100	60
	16 x 60/10	41	M12	72	60	10
	16 x 100/50			112	100	50
	16 x 140/90			152	140	90
	20 x 80/25	41	M16	95	80	25
	20 x 115/60			130	115	60
20 x 150/95	165			150	95	
HLC-SK carbon steel anchors	6,5 x 45/20	16	M5	45	-	20
	6,5 x 65/40			65		40
	6,5 x 85/60			85		60
	8 x 60/25	26	M6	60	-	25
	8 x 75/40			75		40
	8 x 90/55			90		55
	10 x 45/5	31	M8	45	-	5
	10 x 85/45			85		45
	10 x 105/65			105		65
	10 x 130/95			130		95
	12 x 55/15	33	M10	80	-	35

HLC, HLC-H, HLC-EC/EO, HLC-L

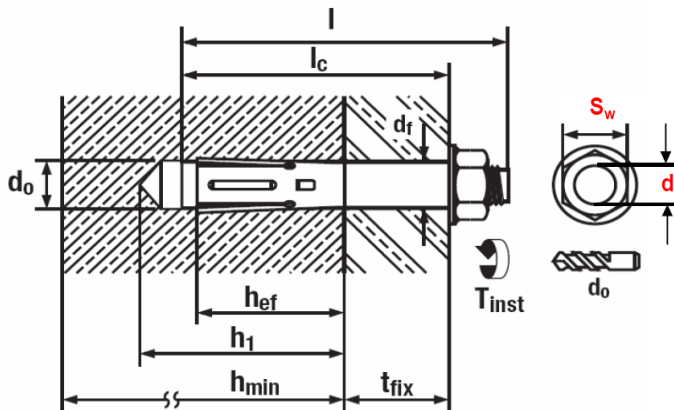

HLC-SK

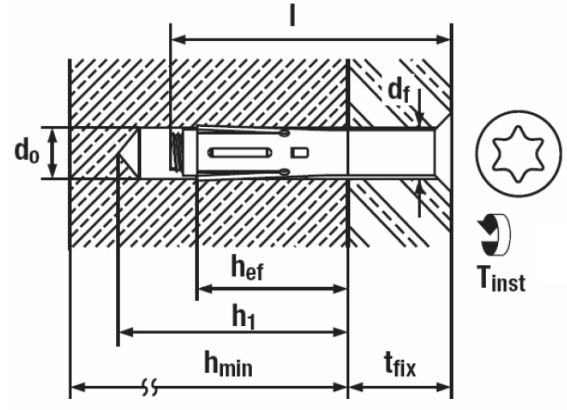

Setting

Installation equipment

Anchor size	6,5	8	10	12	16	20
Rotary hammer	TE 2 – TE 16					
Other tools	hammer, torque wrench, blow out pump					

Setting instruction

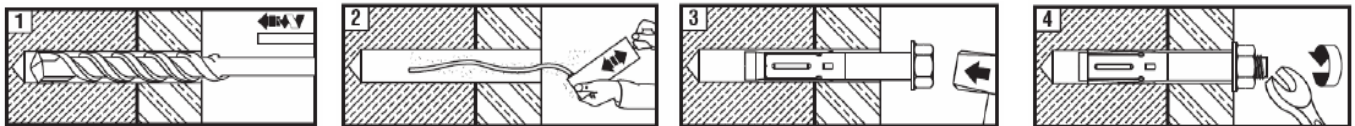

1 Drill hole with drill bit.

2 Blow out dust and fragments.

3 Install the anchor.

4 Apply torque.

For detailed information on installation see instruction for use given with the package of the product.

Setting details HLC

Thread size	d	[mm]	M5 6,5	M6 8	M8 10	M10 12	M12 16	M16 20
Nominal diameter of drill bit	d_0	[mm]	6,5 (1/4")	8	10	12	16	20
Cutting diameter of drill bit	$d_{cut} \leq$	[mm]	6,4	8,45	10,45	12,5	16,5	20,55
Depth of drill hole	$h_1 \geq$	[mm]	30	40	50	65	75	85
Width across nut flats	HLC SW	[mm]	8	10	13	15	19	24
	HLC-H SW	[mm]				17		
	HLS-SK Driver		PZ 3	T 30	T 40	T 40		
Diameter of clearance hole in the fixture	$d_f \leq$	[mm]	7	10	12	14	18	21
Effective anchorage depth	h_{ef}	[mm]	16	26	31	33	41	41
Max. torque moment concrete	T_{inst}	[Nm]	5	8	25	40	50	80
Max. torque moment masonry	T_{inst}	[Nm]	2,5	4	13	20	25	-

Base material thickness, anchor spacing and edge distance

Anchor size			6,5	8	10	12	16	20
Minimum base material thickness	h_{min}	[mm]	60	70	80	100	100	120
Critical spacing for splitting failure and concrete cone failure	s_{cr}	[mm]	60	100	120	130	160	160
Critical edge distance for splitting failure and concrete cone failure	c_{cr}	[mm]	30	50	60	65	80	80

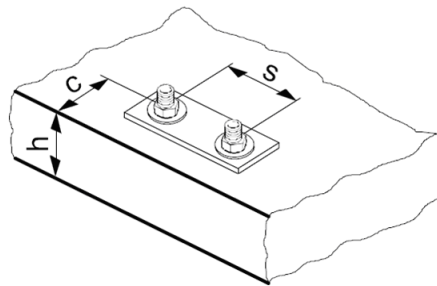



Basic loading data for single anchor in solid masonry units

All data in this section applies to

- Load values valid for holes drilled with TE rotary hammers in hammering mod
- Correct anchor setting (see instruction for use, setting details)
- The core / material ratio may not exceed 15% of a bed joint area.
- The brim area around holes must be at least 70mm
- Edge distances, spacing and other influences, see below

Recommended loads^{a)}

Base material		Anchor size	Hilti				
			6,5	8	10	12	16
Germany, Austria, Switzerland		h_{nom} [mm]	16	26	31	33	41
Solid clay brick Mz12/2,0 	DIN 105/ EN 771-1 $f_b^{b)} \geq 12 \text{ N/mm}^2$	Tensile $N_{rec}^{c)}$ [kN]	0,3	0,5	0,6	0,7	0,8
		Shear $V_{rec}^{c)}$ [kN]	0,45	1,0	1,2	1,4	1,6
Solid sand-lime brick KS 12/2,0 	DIN 106/ EN 771-2 $f_b^{b)} \geq 12 \text{ N/mm}^2$	Tensile $N_{rec}^{d)}$ [kN]	0,4	0,5	0,6	0,8	0,8
		Shear $V_{rec}^{d)}$ [kN]	0,65	1,0	1,2	1,6	1,6

a) Recommended load values for German base materials are based on national regulations.

b) f_b = brick strength

c) Values only valid for Mz (DIN 105) with brick strength $\geq 19 \text{ N/mm}^2$, density $2,0 \text{ kg/dm}^3$, minimum brick size NF (24,0cm x 11,5cm x 11,5cm)

d) Values only valid for KS (DIN 106) with brick strength $\geq 29 \text{ N/mm}^2$, density $2,0 \text{ kg/dm}^3$, minimum brick size NF (24,0cm x 11,5cm x 11,5cm)

Permissible anchor location in brick and block walls

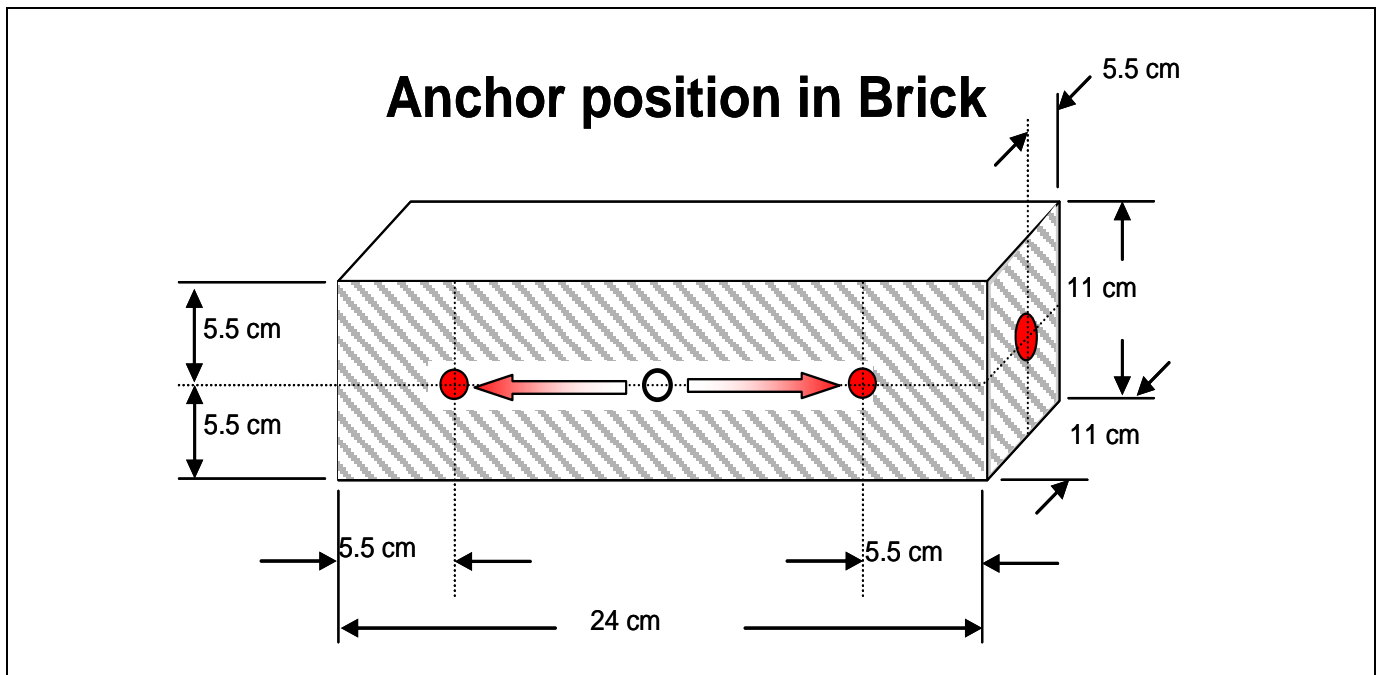



Edge distance and spacing influences

- The technical data for the HLC sleeve anchors are reference loads for MZ 12 and KS 12. Due to the large variation of natural stone solid bricks, on site anchor testing is recommended to validate technical data.
- The HLC anchor was installed and tested in center of solid bricks as shown. The HLC anchor was not tested in the mortar joint between solid bricks or in hollow bricks, however a load reduction is expected.
- For brick walls where anchor position in brick can not be determined, 100% anchor testing is recommended.
- Distance to free edge free edge to solid masonry (Mz and KS) units ≥ 300 mm
- The minimum distance to horizontal and vertical mortar joint (c_{min}) is stated in the drawing above.
- Minimum anchor spacing (s_{min}) in one brick/block is $\geq 2 \cdot c_{min}$

Limits

- Applied load to individual bricks may not exceed 1,0 kN without compression or 1,4 kN with compression
- All data is for multiple use for non structural applications
- Plaster, graveling, lining or levelling courses are regarded as non-bearing and may not be taken into account for the calculation of embedment depth.

HLV Sleeve anchor

	Anchor version	Benefits
 	Pre-setting HLV 6,5x22/7 HLV 8x35/4 HLV 10x45/10 HLV 12x48/10 HLV 12x60/17 HLV 16x68/20	- Available in a variety of sizes in both pre-setting and through fastening configurations - Carbon steel grade 4.8, zinc galvanized to min 5µm
	Through fastening HLV 8x35/10 HLV 10x75/45 HLV 12x95/60 HLV 16x130/90	

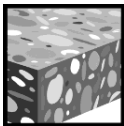

Concrete

Basic loading data (for a single anchor)

All data in this section is Hilti technical data and applies to

- Correct setting (See setting instruction)
- No edge distance and spacing influence
- Minimum base material thickness
- Concrete C20/25 – C50/60, $f_{ck,cube} = 25 \text{ N/mm}^2 - 60 \text{ N/mm}^2$

Characteristic resistance

Anchor size HLV	Pre-setting						Through fastening			
	6,5x22/7	8x35/4	10x45/10	12x48/10	12x60/17	16x68/20	8x35/10	10x75/45	12x95/60	16x130/90
Tensile N_{Rk} [kN]	5,2	7,1	13,0	15,9	21,9	28,3	5,6	8,3	10,5	12,8
Shear V_{Rk} [kN]	3,3	5,6	11,4	13,0	13,0	19,7	5,6	8,3	10,5	12,8

Design resistance

Anchor size HLV	Pre-setting						Through fastening			
	6,5x22/7	8x35/4	10x45/10	12x48/10	12x60/17	16x68/20	8x35/10	10x75/45	12x95/60	16x130/90
Tensile N_{Rd} [kN]	2,5	3,4	6,1	7,5	10,4	13,5	2,7	4,0	5,0	6,1
Shear V_{Rd} [kN]	1,5	2,6	5,4	6,1	6,1	9,4	2,7	4,0	5,0	6,1

Recommended loads

Anchor size HLV	Pre-setting						Through fastening			
	6,5x22/7	8x35/4	10x45/10	12x48/10	12x60/17	16x68/20	8x35/10	10x75/45	12x95/60	16x130/90
Tensile $N_{rec}^{a)}$ [kN]	1,7	2,4	4,3	5,3	7,4	9,6	1,9	2,8	3,6	4,3
Shear $V_{rec}^{a)}$ [kN]	1,0	1,8	3,8	4,3	4,3	6,7	1,9	2,8	3,6	4,3

a) With overall partial safety factor for action $\gamma = 1,4$. The partial safety factors for action depend on the type of loading and shall be taken from national regulations.

Materials

Material quality

Part	Material
Anchor bolt	Carbon steel, $f_{uk} \geq 400 \text{ N/mm}^2$, galvanised to min. 5 μm

Anchor dimensions

Anchor size HLV	Pre-setting						Through fastening			
	6,5x22/7	8x35/4	10x45/10	12x48/10	12x60/17	16x68/20	8x35/10	10x75/45	12x95/60	16x130/90
Thread size d [-]	M5	M6	M8	M10		M12	M6	M8	M10	M12
Diameter of anchor d_o [mm]	6,5	8	10	12		16	8	10	12	16
Length of anchor bolt l [mm]	39	51	68	76	95	109	47	88	114	152
Length of sleeve l_s [mm]	22	35	45	48	60	68	35	75	95	130

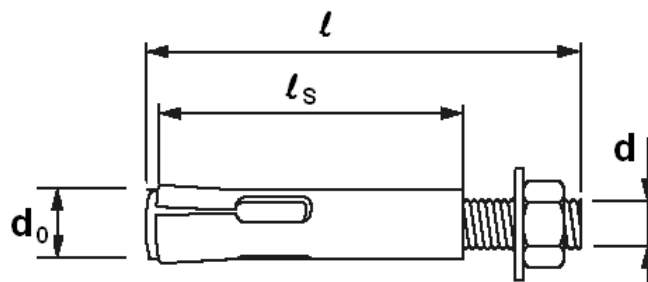

Setting

Installation equipment

Anchor size	6,5	8	10	12	16
Rotary hammer	TE 2 – TE 16				
Other tools	hammer, torque wrench, blow out pump				

Setting instruction

Pre-setting	Through fastening

For detailed information on installation see instruction for use given with the package of the product.

Setting details HLV

Anchor size HLV	Pre-setting						Through fastening			
	6,5x22/7	8x35/4	10x45/10	12x48/10	12x60/17	16x68/20	8x35/10	10x75/45	12x95/60	16x130/90
Thread size [kN]	M5	M6	M8	M10		M12	M6	M8	M10	M12
Thickness of fixture $t_{fix} \leq$ [mm]	7	4	10	10	17	20	10	45	60	90
Nominal diameter of drill bit d_o [mm]	6,5 (1/4")	8	10	12		16	8	10	12	16
Cutting diameter of drill bit $d_{cut} \leq$ [mm]	6,4	8,45	10,45	12,5		16,5	8,45	10,45	12,5	16,5
Depth of drill hole $h_1 \geq$ [mm]	40	50	65	70	80	100	40	50	55	70
Width across nut flats SW [mm]	8	10	13	17		19	10	13	17	19
Diameter of clearance hole in the fixture $d_f \leq$ [mm]	6	7	9	11	11	14	10	12	14	18
Effective anchorage depth h_{ef} [mm]	22	35	45	48	60	68	25	30	35	40
Max. torque moment T_{inst} [Nm]	2	4	25	40		50	4	25	40	50



Base material thickness, anchor spacing and edge distance

Anchor size HLV	Pre-setting						Through fastening			
	6,5x22/7	8x35/4	10x45/10	12x48/10	12x60/17	16x68/20	8x35/10	10x75/45	12x95/60	16x130/90
Minimum base material thickness h_{min} [mm]	80	80	90	100	120	140	80 ^{a)}	80 ^{a)}	80 ^{a)}	80 ^{a)}
Minimum spacing s_{min} [mm]	200	200	200	200	240	280	200	200	200	200
Minimum edge distance c_{min} [mm]	100	105	135	150	180	210	100	100	105	120

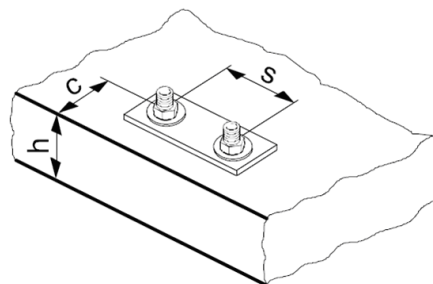
^{a)} in case of deeper embedment than h_{ef} : $h_{min} \geq 2 \times$ embedment depth



HAM Hard sleeve anchor

Anchor version	Benefits
 <p>HAM with steel strength 8.8 screw</p>	<ul style="list-style-type: none"> - secure fastenings in various base materials - cone attached to sleeve to ensure pre-setting - wings to prevent spinning in the borehole - plastic cap in cone to prevent dust entrance - blue-chromate zinc coating - 8.8 steel strength of screw
 <p>HAM</p>	



Concrete

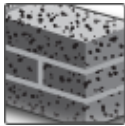

Solid brick

Basic loading data (for a single anchor)

All data in this section applies to

- Correct setting (See setting instruction)
- No edge distance and spacing influence
- Concrete as specified in the table
- Steel failure
Minimum base material thickness
- Concrete C 20/25, $f_{ck,cube} = 25 \text{ N/mm}^2$

Recommended Loads in uncracked concrete C20/25

Thread Diameter	d	[mm]	M6x50	M8x60	M10x80	M12x90
Tension	N_{rec}	[kN]	4,0	4,8	5,8	8,7
Shear	V_{rec}	[kN]	4,6	8,4	13,3	19,3

Recommended Loads in solid brick

Thread Diameter	d	[mm]	M6x50	M8x60	M10x80	M12x90
Tension	N_{rec}	[kN]	For solid brick, load values need to be determined on the building site			
Shear	V_{rec}	[kN]				

Materials

Part	Material	
HAM Anchor	Sleeve	Carbon steel
	Hex head Bolt	Carbon steel DIN 933, Strength 8.8
	Washer	Carbon steel, DIN 9021

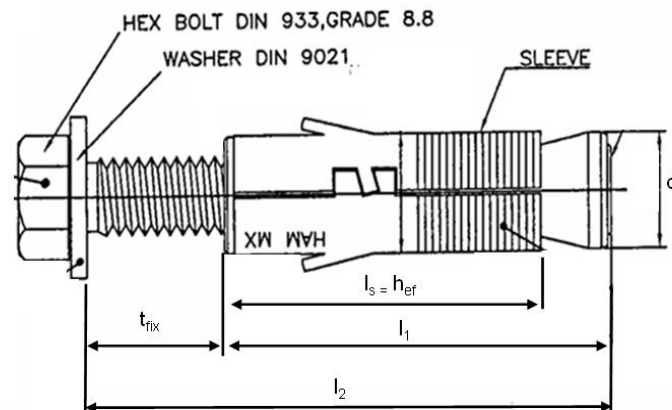

Anchor dimensions

Anchor version	Anchor	h_{ef} [mm]	d [mm]	l_s [mm]	l_1 [mm]	l_2 [mm]	t_{fix} [mm]
HAM	M6 x 50	30	12	30	40	50	10
	M8 x 60	35	14	35	50	60	10
	M10 x 80	43	16	43	60	80	20
	M12 x 90	55	19	55	70	90	20

Setting

Installation equipment

Anchor size		M6x50	M8x60	M10x80	M12x90
Rotary hammer		TE 2 – TE 16			
Drill bit	TE-C3X	12	14	16	20
Other tools		hammer, torque wrench, blow out pump			

For detailed information on installation see instruction for use given with the package of the product.

Setting details for HAM with 8.8 screw

Thread Diameter	d	[mm]	M6x50	M8x60	M10x80	M12x90
Nominal diameter of drill bit	d_o	[mm]	12	14	16	20
Cutting diameter of drill bit	$d_{cut} \leq$	[mm]	12,5	14,5	16,5	20,55
Depth of drill hole	$h_1 \geq$	[mm]	65	80	90	110
Width across nut flats	SW	[mm]	10	13	17	19
Diameter of clearance hole in the fixture	$d_f \leq$	[mm]	7	9	12	14
Max. torque moment concrete	T_{inst}	[Nm]	10	25	45	75
Max. torque moment masonry	T_{inst}	[Nm]	5	10	20	30

HUS3 Screw anchor

	Anchor version	Benefits
	HUS3-H 8 / 10 / 14 Carbon steel concrete screw with hexagonal head	<ul style="list-style-type: none"> - High productivity – less drilling and fewer operations than with conventional anchors - ETA approval for cracked and non-cracked concrete - ETA approval for adjustability (unscrew-rescrew) - Seismic approval ETA C1 - High loads - Small edge and spacing distances - abZ (DIBt) approval for reusability in fresh concrete ($f_{ck,cube}=10/15/20 \text{ Nmm}^2$) for temporary applications - Three embedment depths for maximum design flexibility - HUS3-HF with multilayer coatings for additional corrosion protection
	HUS3-C 8 / 10 Carbon steel concrete screw with countersunk head	
	HUS3-HF 10 / 14 Carbon steel concrete screw with multilayer coating ($\geq 14 \mu\text{m}$) and hexagonal head	



Concrete



Tensile zone

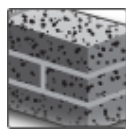

Solid brick

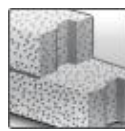

Autoclaved aerated concrete



Seismic
ETA-C1

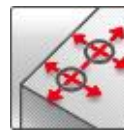

Small edge
distance
and spacing



Fire
resistance

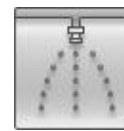

Sprinkler
approved



European
Technical
Approval



CE
conformity



DIBt
Approval
Reusability



PROFIS
Anchor
design
software

Approvals / certificates

Description	Authority / Laboratory	No. / date of issue
European technical assessment ^{a)}	DIBt, Berlin	ETA-13/1038 / 2014-09-19
DIBt approval (Reusability)	DIBt, Berlin	Z-21.8-2018 / 2014-04-01

a) All data given in this section for HUS3-H and HUS3-C according ETA-13/1038, issue 2014-09-19.

Basic loading data (for a single anchor)

All data in this section applies to

For details see Simplified design method

- Correct setting (See setting instruction)
- No edge distance and spacing influence
- Steel failure
- Minimum base material thickness
- Cracked and non-cracked Concrete C 20/25, $f_{ck,cube} = 25 \text{ N/mm}^2$
- Adjustment allowed during the installation for size 8 and 10, types H, C and h_{nom2} only.

Mean ultimate resistance

		Data according ETA-13/1038, issue 2014-09-19.								
Anchor size		8			10			14		
Type	HUS3	H, C			H, C			H		
Nominal embedment depth	h_{nom} [mm]	50	60	70	55	75	85	65	85	115
Non-cracked concrete										
Tensile $N_{Ru,m}$	[kN]	11,9	15,9	21,2	15,9	26,6	36,8	23,2	36,2	59,0
Shear $V_{Ru,m}$	[kN]	17,0	17,9	17,9	18,0	29,4	29,4	46,4	47,3	47,3
Cracked concrete										
Tensile $N_{Ru,m}$	[kN]	8,0	11,9	15,9	12,8	21,4	26,3	16,5	25,8	42,0
Shear $V_{Ru,m}$	[kN]	12,1	17,9	17,9	12,8	29,4	29,4	33,1	47,3	47,3
		Hilti Tech. Data								
Anchor size		10			14					
Type	HUS3	HF			HF					
Nominal embedment depth	h_{nom} [mm]	55	75	85	65	85				
Non-cracked concrete										
Tensile $N_{Ru,m}$	[kN]	15,9	26,6	36,8	23,2	36,2				
Shear $V_{Ru,m}$	[kN]	18,0	25,7	25,7	46,4	47,3				
Cracked concrete										
Tensile $N_{Ru,m}$	[kN]	12,8	21,4	26,3	16,5	25,8				
Shear $V_{Ru,m}$	[kN]	12,8	25,7	25,7	33,1	47,3				

Characteristic resistance

		Data according ETA-13/1038, issue 2014-09-19.								
Anchor size		8			10			14		
Type	HUS3	H, C			H, C			H		
Nominal embedment depth	h_{nom} [mm]	50	60	70	55	75	85	65	85	115
Non-cracked concrete										
Tensile N_{Rk}	[kN]	9,0	12,0	16,0	12,0	20,0	27,8	17,5	27,3	44,4
Shear V_{Rk}	[kN]	12,8	17,0	17,0	13,5	28,0	28,0	35,0	45,0	45,0
Cracked concrete										
Tensile N_{Rk}	[kN]	6,0	9,0	12,0	9,7	16,1	19,8	12,5	19,4	31,7
Shear V_{Rk}	[kN]	9,1	17,0	17,0	9,7	28,0	28,0	24,9	38,9	45,0
		Hilti Tech. Data								
Anchor size		10			14					
Type	HUS3	HF			HF					
Nominal embedment depth	h_{nom} [mm]	55	75	85	65	85				
Non-cracked concrete										
Tensile N_{Rk}	[kN]	12,0	20,0	27,8	17,5	27,3				
Shear V_{Rk}	[kN]	13,5	24,5	24,5	35,0	45,0				
Cracked concrete										
Tensile N_{Rk}	[kN]	9,7	16,1	19,8	12,5	19,4				
Shear V_{Rk}	[kN]	9,7	24,5	24,5	24,9	38,9				

Design resistance

		Data according ETA-13/1038, issue 2014-09-19.								
Anchor size		8			10			14		
Type	HUS3	H, C			H, C			H		
Nominal embedment depth	h_{nom} [mm]	50	60	70	55	75	85	65	85	115
Non-cracked concrete										
Tensile N_{Rd}	[kN]	6,0	8,0	10,7	8,0	13,3	18,5	11,7	18,2	29,6
Shear V_{Rd}	[kN]	8,5	11,3	11,3	9,0	18,7	18,7	23,3	30,0	30,0
Cracked concrete										
Tensile N_{Rd}	[kN]	4,0	6,0	8,0	6,4	10,8	13,2	8,3	13,0	21,1
Shear V_{Rd}	[kN]	6,1	11,3	11,3	6,4	18,7	18,7	16,6	25,9	30,0
		Hilti Tech. Data								
Anchor size		10			14					
Type	HUS3	HF			HF					
Nominal embedment depth	h_{nom} [mm]	55	75	85	65	85				
Non-cracked concrete										
Tensile N_{Rd}	[kN]	8,0	13,3	18,5	11,7	18,2				
Shear V_{Rd}	[kN]	9,0	16,3	16,3	23,3	30,0				
Cracked concrete										
Tensile N_{Rd}	[kN]	6,4	10,8	13,2	8,3	13,0				
Shear V_{Rd}	[kN]	6,4	16,3	16,3	16,6	25,9				

Recommended load

		Data according ETA-13/1038, 2014-09-19.								
Anchor size		8			10			14		
Type	HUS3	H, C			H, C			H		
Nominal embedment depth	h_{nom} [mm]	50	60	70	55	75	85	65	85	115
Non-cracked concrete										
Tensile N_{Rec}	[kN]	4,3	5,7	7,6	5,7	9,5	13,2	8,3	13,0	21,2
Shear V_{Rec}	[kN]	6,1	8,1	8,1	6,5	13,3	13,3	16,6	21,4	21,4
Cracked concrete										
Tensile N_{Rec}	[kN]	2,9	4,3	5,7	4,6	7,7	9,4	5,9	9,3	15,1
Shear V_{Rec}	[kN]	4,3	8,1	8,1	4,6	13,3	13,3	11,9	18,5	21,4
		Hilti Tech. Data								
Anchor size		10			14					
Type	HUS3	HF			HF					
Nominal embedment depth	h_{nom} [mm]	55	75	85	65	85				
Non-cracked concrete										
Tensile N_{Rec}	[kN]	5,7	9,5	13,2	8,3	13,0				
Shear V_{Rec}	[kN]	6,5	11,7	11,7	16,6	21,4				
Cracked concrete										
Tensile N_{Rec}	[kN]	4,6	7,7	9,4	5,9	9,3				
Shear V_{Rec}	[kN]	4,6	11,7	11,7	11,9	18,5				

a) With overall partial safety factor for action $\gamma = 1,4$. The partial safety factors for action depend on the type of loading and shall be taken from national regulations.

Materials

Mechanical properties

Anchor size		8	10	10	14
Type	HUS3	H, C	H, C	HF	H, HF
Nominal tensile strength f_{uk}	[N/mm ²]	810	805	705	730
Yield strength f_{yk}	[N/mm ²]	695	690	605	630
Stressed cross-section A_s	[mm ²]	48,4	77,0	77,0	131,7
Moment of resistance W	[mm ³]	47	95	95	213
Char, bending resistance $M_{Rk,s}^0$	[Nm]	46	92	81	187

Material quality

Type	Material	Coating
HUS3-H / HUS3-C	Carbon-steel	Galvanized ($\geq 5 \mu\text{m}$)
HUS3-HF	Carbon-steel	Multilayer coating ($\geq 14 \mu\text{m}$)

Anchor dimensions

Dimensions

Anchor size			8	10	14
Type			H, C	H, C, HF	H, HF
Threaded outer diameter	d_t	[mm]	10,30	12,40	16,85
Core diameter	d_k	[mm]	7,85	9,90	12,95
Shaft diameter	d_s	[mm]	8,45	10,55	13,80
Stressed section	A_s	[mm ²]	48,4	77,0	131,7

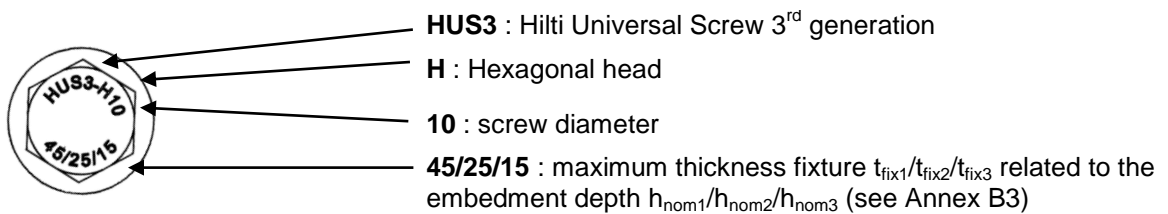
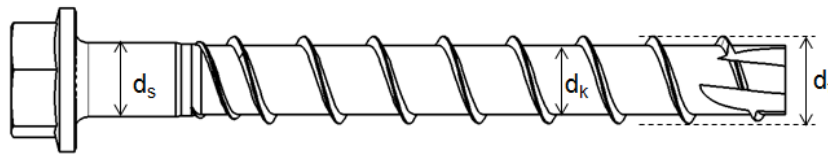

Screw length and thickness of fixture for HUS3-H (hex head, galvanized)

Anchor size	HUS3-H	8			10			14		
		h_{nom1} 50	h_{nom2} 60	h_{nom3} 70	h_{nom1} 55	h_{nom2} 75	h_{nom3} 85	h_{nom1} 65	h_{nom2} 85	h_{nom3} 115
Nominal anchorage depth [mm]		Thickness of fixture [mm]								
		t_{fix1}	t_{fix2}	t_{fix3}	t_{fix1}	t_{fix2}	t_{fix3}	t_{fix1}	t_{fix2}	t_{fix3}
Length of anchor [mm]		5	-	-	-	-	-	-	-	-
55		-	-	-	5	-	-	-	-	-
60		15	5	-	-	-	-	-	-	-
65		-	-	-	15	-	-	-	-	-
70		25	15	5	-	-	10	-	-	-
75		-	-	-	25	5	-	-	-	-
80		35	25	15	-	-	-	-	-	-
85		-	-	-	35	15	5	-	-	-
90		50	40	30	45	25	15	35	15	-
100		-	-	-	55	35	25	-	-	-
110		70	60	50	-	-	-	-	-	-
120		-	-	-	75	55	45	65	45	15
130		100	90	80	95	75	65	85	65	35
150										

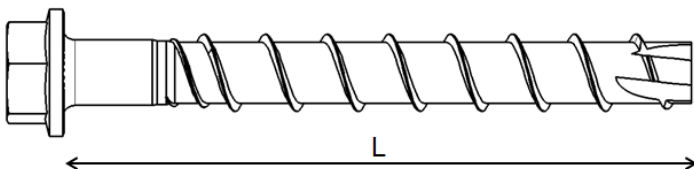

Screw length and thickness of fixture for HUS3-HF (hex head, multilayer coating)

Anchor size	HUS3-HF	10			14	
Nominal anchorage depth [mm]	h_{nom1}	h_{nom2}	h_{nom3}	h_{nom1}	h_{nom2}	
	55	75	85	65	85	
Length of anchor [mm]	Thickness of fixture [mm]					
	t_{fix1}	t_{fix2}	t_{fix3}	t_{fix1}	t_{fix2}	
60	5	-	-	-	-	
75	-	-	-	10	-	
80	25	5	-	-	-	
100	45	25	15	35	15	
110	55	35	25	-	-	

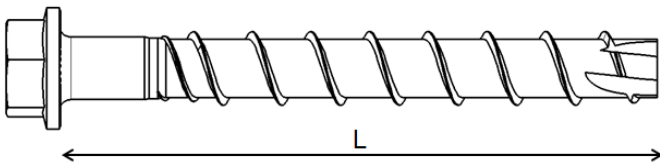

Screw length and thickness of fixture for HUS3-C (countersunk head, galvanized)

Anchor size	HUS3-C	8			10		
Nominal anchorage depth [mm]	h_{nom1}	h_{nom2}	h_{nom3}	h_{nom1}	h_{nom2}	h_{nom3}	
	50	60	70	55	75	85	
Length of anchor [mm]	Thickness of fixture [mm]						
	t_{fix1}	t_{fix2}	t_{fix3}	t_{fix1}	t_{fix2}	t_{fix3}	
65	15	5	-	-	-	-	
70	-	-	-	15	-	-	
75	25	15	-	-	-	-	
85	35	25	15	-	-	-	
90	-	-	-	35	15	-	
100	-	-	-	45	25	15	

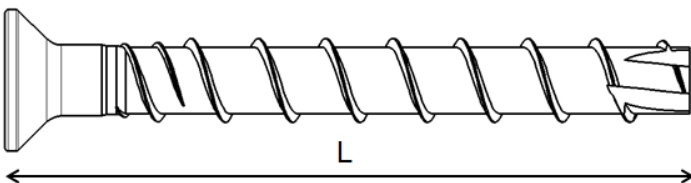

Setting

Installation equipment

Anchor size	8	10	14
Type HUS3	H, C	H, C, HF	H, HF
Rotary hammer	TE 2 – TE 30	TE 2 – TE 30	TE 2 – TE 30
Drill bit for concrete, solid clay brick and solid sand-lime brick	CX 8	CX 10	CX 14
Drill bit for aerated concrete	CX 6	CX 8	-
Socket wrench insert	S-NSD 13 1/2	S-NSD 15 1/2	S-NSD 21 1/2
Torx	S-SY TX45	S-SY TX50	-
Tube for temporary application (only for H type)	HRG 8	HRG 10	HRG 14
Setting tool for concrete C12/15 to C50/60	SIW 22T-A		
Setting tool for solid brick and aerated concrete	SFH 22A		
Setting tool for hollow core slab	SIW 22 A		

Setting details for concrete

Anchor size		8			10			14		
Type	HUS3	H, C			H, C, HF			H, HF		H
Nominal anchorage depth	h_{nom} [mm]	50	60	70	55	75	85	65	85	115
Nominal diameter of drill bit	d_o [mm]	8			10			14		
Cutting diameter of drill bit	$d_{cut} \leq$ [mm]	8,45			10,45			14,50		
Depth of drill hole	$h_1 \geq$ [mm]	60	70	80	65	85	95	75	95	125
Diameter of clearance hole in the fixture	$d_f \leq$ [mm]	12			14			18		
Diameter of countersunk head	d_h [mm]	18			21			-		
Width across (H, HF types)	SW [mm]	13			15			21		
Torx (C type)	TX [-]	45			50			-		
Impact screw driver		Hilti SIW 22 T-A								

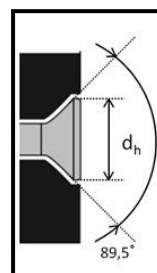
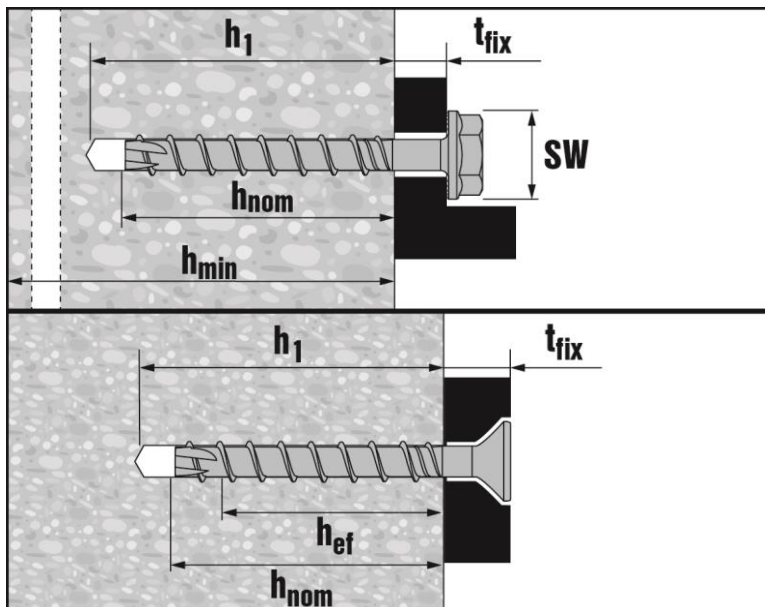

Setting instruction

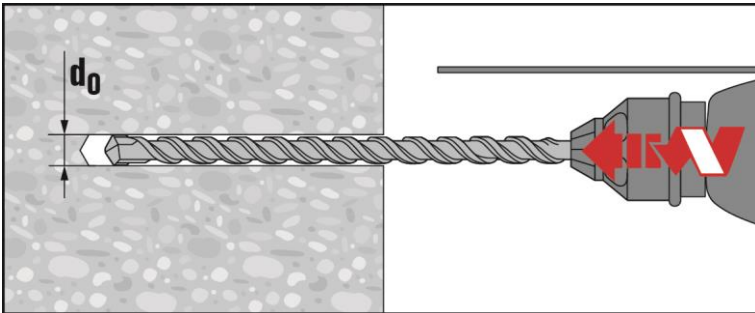

Make a cylindrical hole

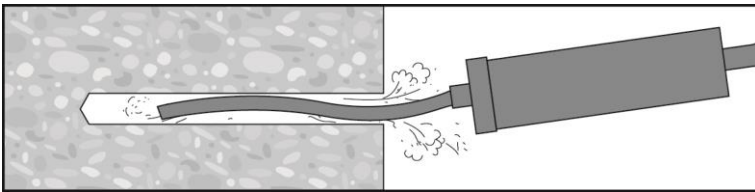

Clean the borehole

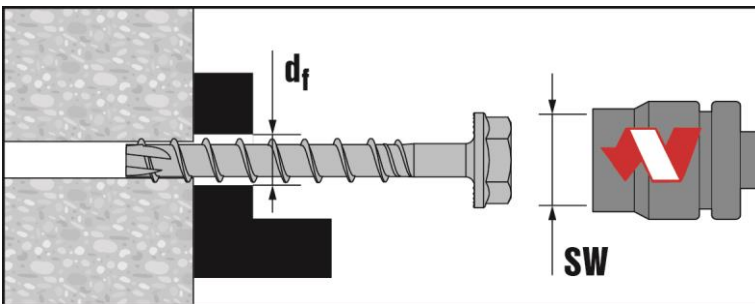

Install the screw anchor by impact screw driver Hilti SIW 22T-A

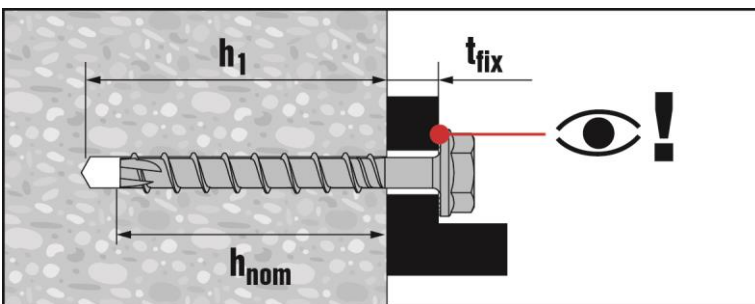

Ensure that the fixture is caught

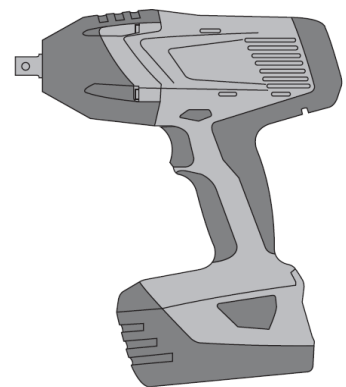

For detailed information on installation see instruction for use given with the package of the product.

**Setting instruction in case of adjustment process
(recommended for HUS3-H,C size 8 and 10 for standard embedment depth h_{nom2} only)**

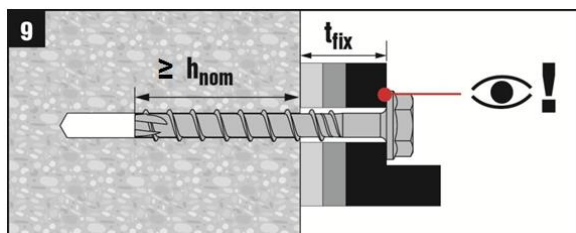
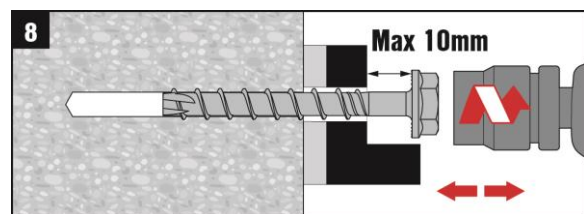
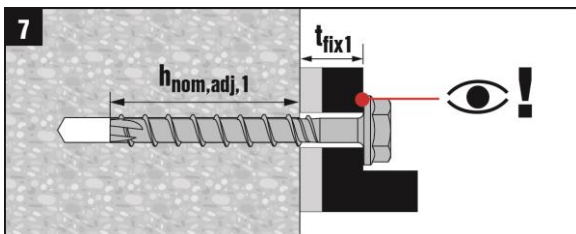
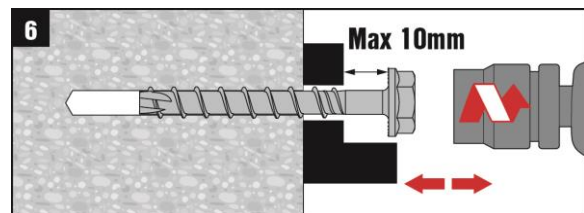
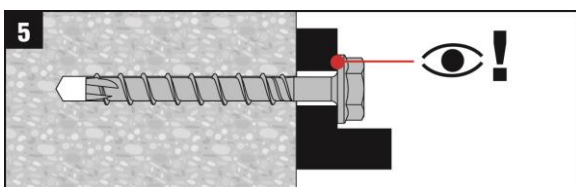
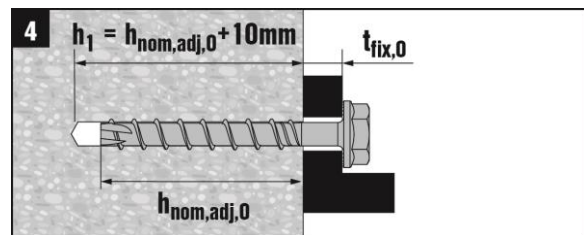
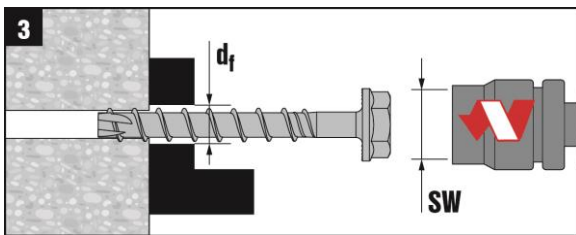
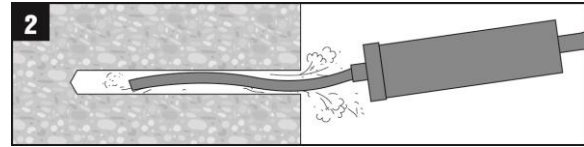
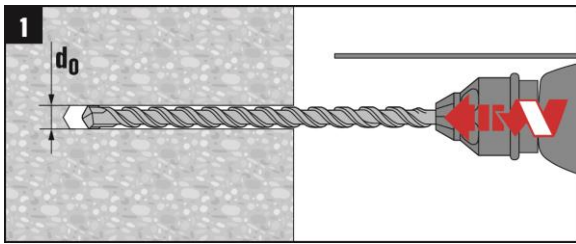

For setting HUS3-H,C 8 ($h_{nom2}=60\text{mm}$) and HUS3-H,C 10 ($h_{nom2}=75\text{mm}$) it is allowed to adjust (loosening max. 10mm and re-tightening) the screw. The adjustment can be done maximum two times, $n_a=2$. The final embedment depth after adjustment process must be larger or equal than h_{nom2} . The total allowed thickness of shims added during the adjustment process $t_{adj}=10\text{mm}$.

Design parameters

Anchor size		8			10			14		
Type	HUS3	H, C			H, C, HF			H, HF		H
Nominal anchorage depth	h_{nom} [mm]	50	60	70	55	75	85	65	85	115
Effective anchorage depth	h_{ef} [mm]	40	46,4	54,9	41,6	58,6	67,1	49,3	66,3	91,8
Minimum base material thickness	h_{min} [mm]	100	100	120	100	130	140	120	160	200
Minimum spacing	s_{min} [mm]	40	50	50	50	50	60	60	75	75
Minimum edge distance	c_{min} [mm]	50	50	50	50	50	60	60	75	75
Critical spacing for splitting failure	$s_{cr,sp}$ [mm]	120	140	170	130	180	220	170	200	280
Critical edge distance for splitting failure	$c_{cr,sp}$ [mm]	60	70	85	65	90	110	85	100	140
Critical spacing for concrete cone failure	$s_{cr,N}$ [mm]	120	140	170	130	180	202	150	200	280
Critical edge distance for concrete cone failure	$c_{cr,N}$ [mm]	60	70	85	65	90	101	75	100	140

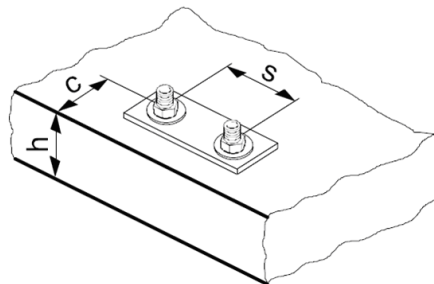

For spacing (edge distance) smaller than critical spacing (critical edge distance) the design loads have to be reduced.

Simplified design method

Simplified version of the design method according ETAG 001, Annex C. Design resistance according ETA-13/1038, issue 2014-03-26 (HUS3-H and C types only).

- Influence of concrete strength
- Influence of edge distance
- Influence of spacing
- Valid for a group of two anchors. (The method may also be applied for anchor groups with more than two anchors or more than one edge. The influencing factors must then be considered for each edge distance and spacing. The calculated design loads are then conservative: They will be lower than the exact values according ETAG 001, Annex C. To avoid this, it is recommended to use the anchor design software PROFIS anchor).

The design method is based on the following simplification:

- No different loads are acting on individual anchors (no eccentricity)

The values are valid for one anchor.

For more complex fastening applications please use the anchor design software PROFIS Anchor.

Tension loading

The design tensile resistance is the lower value of

- Steel resistance: $N_{Rd,s}$
- Concrete pull-out resistance: $N_{Rd,p} = N_{Rd,p}^0 \cdot f_B$
- Concrete cone resistance: $N_{Rd,c} = N_{Rd,c}^0 \cdot f_B \cdot f_{1,N} \cdot f_{2,N} \cdot f_{3,N} \cdot f_{re,N}$
- Concrete splitting resistance (only non-cracked concrete):
 $N_{Rd,sp} = N_{Rd,c}^0 \cdot f_B \cdot f_{1,sp} \cdot f_{2,sp} \cdot f_{3,sp} \cdot f_{h,sp} \cdot f_{re,N}$

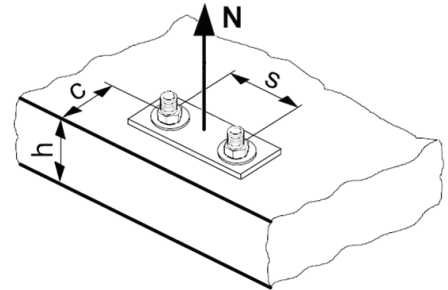

Basic design tensile resistance

Design steel resistance $N_{Rd,s}$

		Data according ETA-13/1038, 2014-09-19.		
Anchor size		8	10	14
Type	HUS3	H, C	H, C	H
$N_{Rd,s}$	[kN]	28,0	44,4	69,0
		Hilti Tech. Data		
Anchor size		10	14	
Type	HUS3	HF	HF	
$N_{Rd,s}$	[kN]	38,7	69,0	

Design pull-out resistance $N_{Rd,p} = N_{Rd,p}^0 \cdot f_B$

		Data according ETA-13/1038, 2014-09-19.									
Anchor size		8			10			14			
Type		H, C			H, C			H			
Nominal anchorage depth	h_{nom} [mm]	50	60	70	55	75	85	65	85	115	
Non-cracked concrete											
$N_{Rd,p}^0$	[kN]	6,0	8,0	10,7	8,0	13,3	No pull-out	No pull-out			
Cracked concrete											
$N_{Rd,p}^0$	[kN]	4,0	6,0	8,0	No pull-out			No pull-out			
		Hilti Tech. Data									
Anchor size		10			14						
Type		HF			HF						
Nominal anchorage depth	h_{nom} [mm]	55	75	85	65	85					
Non-cracked concrete											
$N_{Rd,p}^0$	[kN]	8,0	13,3	No pull-out	No pull out						
Cracked concrete											
$N_{Rd,p}^0$	[kN]	No pull-out			No pull-out						

Design concrete cone resistance $N_{Rd,c} = N_{Rd,c}^0 \cdot f_B \cdot f_{1,N} \cdot f_{2,N} \cdot f_{3,N} \cdot f_{re,N}$

Design splitting resistance ^{a)} $N_{Rd,sp} = N_{Rd,c}^0 \cdot f_B \cdot f_{1,sp} \cdot f_{2,sp} \cdot f_{3,sp} \cdot f_{h,sp} \cdot f_{re,N}$

		Data according ETA-13/1038, 2014-09-19.								
Anchor size		8			10			14		
Type	HUS3	H, C			H, C			H		
Nominal anchorage depth	h_{nom} [mm]	50	60	70	55	75	85	65	85	115
Non-cracked concrete										
$N_{Rd,c}^0$	[kN]	8,5	10,6	13,7	9,0	15,1	18,5	11,7	18,2	29,6
Cracked concrete										
$N_{Rd,c}^0$	[kN]	6,1	7,6	9,8	6,4	10,8	13,2	8,3	13,0	21,1
		Hilti Tech. Data								
Anchor size		10			14					
Type	HUS3	HF			HF					
Nominal anchorage depth	h_{nom} [mm]	55	75	85	65	85				
Non-cracked concrete										
$N_{Rd,p}^0$	[kN]	9,0	15,1	18,5	11,7	18,2				
Cracked concrete										
$N_{Rd,p}^0$	[kN]	6,4	10,8	13,2	8,3	13,0				

Influencing factors

Influence of concrete strength

Concrete strength designation (ENV 206)	C 20/25	C 25/30	C 30/37	C 35/45	C 40/50	C 45/55	C 50/60
Pull-out , concrete cone and splitting resistance							
$f_B = (f_{ck,cube}/25N/mm^2)^{1/2}$ ^{a)}	1	1,1	1,22	1,34	1,41	1,48	1,55

a) $f_{ck,cube}$ = concrete compressive strength, measured on cubes with 150 mm side length.

Influence of edge distance ^{a)}

$c/c_{cr,N}$	0,1	0,2	0,3	0,4	0,5	0,6	0,7	0,8	0,9	1
$c/c_{cr,sp}$										
$f_{1,N} = 0,7 + 0,3 \cdot c/c_{cr,N} \leq 1$	0,73	0,76	0,79	0,82	0,85	0,88	0,91	0,94	0,97	1
$f_{1,sp} = 0,7 + 0,3 \cdot c/c_{cr,sp} \leq 1$										
$f_{2,N} = 0,5 \cdot (1 + c/c_{cr,N}) \leq 1$	0,55	0,60	0,65	0,70	0,75	0,80	0,85	0,90	0,95	1
$f_{2,sp} = 0,5 \cdot (1 + c/c_{cr,sp}) \leq 1$										

a) The edge distance shall not be smaller than the minimum edge distance c_{min} given in the table with the setting details, These influencing factors must be considered for every edge distance.

Influence of anchor spacing ^{a)}

$s/s_{cr,N}$	0,1	0,2	0,3	0,4	0,5	0,6	0,7	0,8	0,9	1
$s/s_{cr,sp}$										
$f_{3,N} = 0,5 \cdot (1 + s/s_{cr,N}) \leq 1$										
$f_{3,sp} = 0,5 \cdot (1 + s/s_{cr,sp}) \leq 1$	0,55	0,60	0,65	0,70	0,75	0,80	0,85	0,90	0,95	1

a) The anchor spacing shall not be smaller than the minimum anchor spacing s_{min} given in the table with the setting details. This influencing factor must be considered for every anchor spacing.

Influence of base material thickness

h/h_{min}	1,0	1,1	1,2	1,3	1,4	1,5	1,6	1,7	1,8	$\geq 1,84$
$f_{h,sp} = [h/(h_{min})]^{2/3}$	1	1,07	1,13	1,19	1,25	1,31	1,37	1,42	1,48	1,5

Influence of reinforcement ^{a)}

Anchor size		8			10			14		
Type	HUS3	H, C, HF			H, C, HF			H, HF		
Nominal anchorage depth	h_{nom} [mm]	50	60	70	55	75	85	65	85	115
$f_{re,N} = 0,5 + h_{ef}/200mm \leq 1$		0,70	0,73	0,77	0,71	0,79	0,84	0,75	0,83	0,96

d) This factor applies only for dense reinforcement, If in the area of anchorage there is reinforcement with a spacing ≥ 150 mm (any diameter) or with a diameter ≤ 10 mm and a spacing ≥ 100 mm, then a factor $f_{re,N} = 1$ may be applied.

Shear loading

The design shear resistance is the lower value of

- Steel resistance: $V_{Rd,s}$
- Concrete pryout resistance: $V_{Rd,cp} = k \cdot N_{Rd,c}$
- Concrete edge resistance: $V_{Rd,c} = V_{Rd,c}^0 \cdot f_B \cdot f_{\beta} \cdot f_h \cdot f_4 \cdot f_{hef} \cdot f_c$

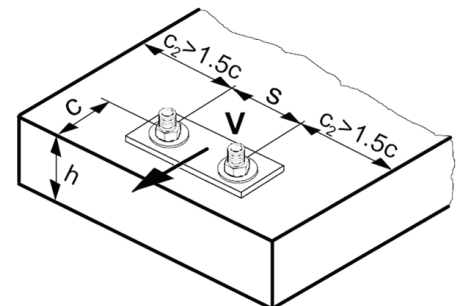

Basic design shear resistance

Design steel resistance $V_{Rd,s}$

		Data according ETA-13/1038, issue 2014-09-19.		
Anchor size		8	10	14
Type	HUS3	H, C	H, C	H,
$V_{Rd,s}$	[kN]	11,3	18,7	30,0
		Hilti Tech. Data		
Anchor size		10	14	
Type	HUS3	HF	HF	
$V_{Rd,s}$	[kN]	16,3	30,0	

Design concrete pry-out resistance $V_{Rd,cp} = k \cdot N_{Rd,c}$ ^{a)}

		Data according ETA-13/1038, issue 2014-09-19.								
Anchor size		8			10			14		
Type		H, C			H, C, HF			H, HF		H
Nominal anchorage depth	h_{nom} [mm]	50	60	70	55	75	85	65	85	115
k		1,0	2,0	2,0	1,0	2,0	2,0	2,0	2,0	2,0
		Hilti Tech. Data								
Anchor size		10			14					
Type	HUS3	HF			HF					
Nominal anchorage depth	h_{nom} [mm]	55	75	85	65	85				
k	[kN]	1,0	2,0	2,0	2,0	2,0				

a) $N_{Rd,c}$: Design concrete cone resistance

Design concrete edge resistance $^a)V_{Rd,c} = V_{Rd,c}^0 \cdot f_B \cdot f_\beta \cdot f_h \cdot f_4 \cdot f_{hef} \cdot f_c$

Data according ETA-13/1038, issue 2014-09-19.											
Anchor size		8			10			14			
Type		H, C			H, C			H			
Nominal anchorage depth	h_{nom} [mm]	50	60	70	55	75	85	65	85	115	
Non-cracked concrete											
$V_{Rd,c}^0$	[kN]	6,0	6,0	6,0	8,6	8,6	8,6	15,0	15,1	15,2	
Cracked concrete											
$V_{Rd,c}^0$	[kN]	4,2	4,2	4,2	6,1	6,1	6,1	10,6	10,7	10,7	
Hilti Tech. Data											
Anchor size		10			14						
Type		HF			HF						
Nominal anchorage depth	h_{nom} [mm]	55	75	85	65	85					
Non-cracked concrete											
$V_{Rd,c}^0$	[kN]	8,6	8,6	8,6	15,0	15,1					
Cracked concrete											
$V_{Rd,c}^0$	[kN]	6,1	6,1	6,1	10,6	10,7					

c) For anchor groups only the anchors close to the edge must be considered.

Influencing factors

Influence of concrete strength

Concrete strength designation (ENV 206)	C 20/25	C 25/30	C 30/37	C 35/45	C 40/50	C 45/55	C 50/60
$f_B = (f_{ck,cube}/25N/mm^2)^{1/2}$ a)	1	1,1	1,22	1,34	1,41	1,48	1,55

a) $f_{ck,cube}$ = concrete compressive strength, measured on cubes with 150 mm side length.

Influence of angle between load applied and the direction perpendicular to the free edge

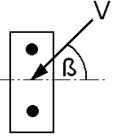
Angle β	0°	10°	20°	30°	40°	50°	60°	70°	80°	≥ 90°
$f_\beta = \frac{1}{\sqrt{(\cos \alpha_V)^2 + \left(\frac{\sin \alpha_V}{2,5}\right)^2}}$ 	1	1,01	1,05	1,13	1,24	1,40	1,64	1,97	2,32	2,50

Influence of base material thickness

h/c	0,15	0,3	0,45	0,6	0,75	0,9	1,05	1,2	1,35	≥ 1,5
$f_h = \{h/(1,5 \cdot c)\}^{1/2} \leq 1$	0,32	0,45	0,55	0,63	0,71	0,77	0,84	0,89	0,95	1,00

Influence of anchor spacing and edge distance ^{a)} for concrete edge resistance: f_4
 $f_4 = (c/h_{ef})^{1,5} \cdot (1 + s / [3 \cdot c]) \cdot 0,5$

c/h _{ef}	Single anchor	Group of two anchors s/h _{ef}														
		0,75	1,50	2,25	3,00	3,75	4,50	5,25	6,00	6,75	7,50	8,25	9,00	9,75	10,50	11,25
0,50	0,35	0,27	0,35	0,35	0,35	0,35	0,35	0,35	0,35	0,35	0,35	0,35	0,35	0,35	0,35	0,35
0,75	0,65	0,43	0,54	0,65	0,65	0,65	0,65	0,65	0,65	0,65	0,65	0,65	0,65	0,65	0,65	0,65
1,00	1,00	0,63	0,75	0,88	1,00	1,00	1,00	1,00	1,00	1,00	1,00	1,00	1,00	1,00	1,00	1,00
1,25	1,40	0,84	0,98	1,12	1,26	1,40	1,40	1,40	1,40	1,40	1,40	1,40	1,40	1,40	1,40	1,40
1,50	1,84	1,07	1,22	1,38	1,53	1,68	1,84	1,84	1,84	1,84	1,84	1,84	1,84	1,84	1,84	1,84
1,75	2,32	1,32	1,49	1,65	1,82	1,98	2,15	2,32	2,32	2,32	2,32	2,32	2,32	2,32	2,32	2,32
2,00	2,83	1,59	1,77	1,94	2,12	2,30	2,47	2,65	2,83	2,83	2,83	2,83	2,83	2,83	2,83	2,83
2,25	3,38	1,88	2,06	2,25	2,44	2,63	2,81	3,00	3,19	3,38	3,38	3,38	3,38	3,38	3,38	3,38
2,50	3,95	2,17	2,37	2,57	2,77	2,96	3,16	3,36	3,56	3,76	3,95	3,95	3,95	3,95	3,95	3,95
2,75	4,56	2,49	2,69	2,90	3,11	3,32	3,52	3,73	3,94	4,15	4,35	4,56	4,56	4,56	4,56	4,56
3,00	5,20	2,81	3,03	3,25	3,46	3,68	3,90	4,11	4,33	4,55	4,76	4,98	5,20	5,20	5,20	5,20
3,25	5,86	3,15	3,38	3,61	3,83	4,06	4,28	4,51	4,73	4,96	5,18	5,41	5,63	5,86	5,86	5,86
3,50	6,55	3,51	3,74	3,98	4,21	4,44	4,68	4,91	5,14	5,38	5,61	5,85	6,08	6,31	6,55	6,55
3,75	7,26	3,87	4,12	4,36	4,60	4,84	5,08	5,33	5,57	5,81	6,05	6,29	6,54	6,78	7,02	7,26
4,00	8,00	4,25	4,50	4,75	5,00	5,25	5,50	5,75	6,00	6,25	6,50	6,75	7,00	7,25	7,50	7,75
4,25	8,76	4,64	4,90	5,15	5,41	5,67	5,93	6,18	6,44	6,70	6,96	7,22	7,47	7,73	7,99	8,25
4,50	9,55	5,04	5,30	5,57	5,83	6,10	6,36	6,63	6,89	7,16	7,42	7,69	7,95	8,22	8,49	8,75
4,75	10,35	5,45	5,72	5,99	6,27	6,54	6,81	7,08	7,36	7,63	7,90	8,17	8,45	8,72	8,99	9,26
5,00	11,18	5,87	6,15	6,43	6,71	6,99	7,27	7,55	7,83	8,11	8,39	8,66	8,94	9,22	9,50	9,78
5,25	12,03	6,30	6,59	6,87	7,16	7,45	7,73	8,02	8,31	8,59	8,88	9,17	9,45	9,74	10,02	10,31
5,50	12,90	6,74	7,04	7,33	7,62	7,92	8,21	8,50	8,79	9,09	9,38	9,67	9,97	10,26	10,55	10,85

a) The anchor spacing and the edge distance shall not be smaller than the minimum anchor spacing s_{min} and the minimum edge distance c_{min} .

Influence of embedment depth

Anchor size	8			10			14		
Type	H, C			H, C, HF			H, HF		H
Nominal anchorage depth h_{nom} [mm]	50	60	70	55	75	85	65	85	115
$f_{hef} = 0,05 \cdot (h_{ef} / d)^{1,68}$	0,75	0,96	1,27	0,55	0,98	1,22	0,41	0,68	1,18

Influence of edge distance ^{a)}

c/d	4	6	8	10	15	20	30	40
$f_c = (d / c)^{0,19}$	0,77	0,71	0,67	0,65	0,60	0,57	0,52	0,50

a) The edge distance shall not be smaller than the minimum edge distance c_{min} .

Precalculated values

Design resistance calculated according ETAG 001, Annex C and data given in ETA-13/1038 issue 2014-09-19.
All data applies to concrete C 20/25 – $f_{ck,cube} = 25 \text{ N/mm}^2$.

Design resistance

Single anchor, no edge effects

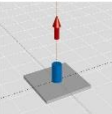
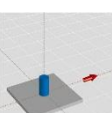
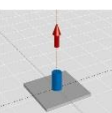
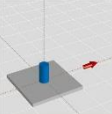
		Data according ETA-13/1038, issue 2014-03-26.								
Anchor size		8			10			14		
Type	HUS3	H, C			H, C			H		
Nominal anchorage depth	h_{nom} [mm]	50	60	70	55	75	85	65	85	115
Min, base material thickness	h_{min} [mm]	100	100	120	100	130	140	120	160	200
	Tensile N_{Rd}									
	Non-cracked concrete									
	[kN]	6,0	8,0	10,7	8,0	13,3	18,5	11,7	18,2	29,6
	Cracked concrete									
	[kN]	4,0	6,0	8,0	6,4	10,8	13,2	8,3	13,0	21,1
	Shear V_{Rd}, without lever arm									
Non-cracked concrete										
[kN]	8,5	11,3	11,3	9,0	18,7	18,7	23,3	30,0	30,0	
Cracked concrete										
[kN]	6,1	11,3	11,3	6,4	18,7	18,7	16,6	25,9	30,0	
Hilti Tech. Data										
Anchor size		10			14					
Type	HUS3	HF			HF					
Nominal anchorage depth	h_{nom} [mm]	55	75	85	65	85				
Min, base material thickness	h_{min} [mm]	100	100	100	130	140				
	Tensile N_{Rd}									
	Non-cracked concrete									
	[kN]	8,0	13,3	18,5	11,7	18,2				
Cracked concrete										
[kN]	6,4	10,8	13,2	8,3	13,0					
	Shear V_{Rd}, without lever arm									
	Non-cracked concrete									
	[kN]	9,0	16,3	16,3	23,3	30,0				
Cracked concrete										
[kN]	6,4	16,3	16,3	16,6	25,9					

Single anchor, min. edge distance ($c = c_{min}$)

		Data according ETA-13/1038, issue 2014-09-19.								
Anchor size		8			10			14		
Type	HUS3	H, C			H, C			H		
Nominal anchorage depth	h_{nom} [mm]	50	60	70	55	75	85	65	85	115
Min. base material thickness	h_{min} [mm]	100	100	120	100	130	140	120	160	200
Min. edge distance	c_{min} [mm]	50	50	50	50	50	60	60	75	75
	Tensile N_{Rd}									
	Non-cracked concrete									
	[kN]	6,0	8,0	9,5	7,4	10,2	12,3	9,1	14,7	19,6
	Cracked concrete									
[kN]	4,0	5,9	6,8	5,3	7,3	8,8	6,5	10,5	14,0	
	Shear V_{Rd}, without lever arm									
	Non-cracked concrete									
	[kN]	4,4	4,5	4,6	4,6	4,9	6,4	6,3	9,0	9,6
	Cracked concrete									
[kN]	3,1	3,2	3,3	3,2	3,5	4,5	4,5	6,4	6,8	
		Hilti Tech. Data								
Anchor size		10			14					
Type	HUS3	HF			HF					
Nominal anchorage depth	h_{nom} [mm]	55	75	85	65	85				
Min. base material thickness	h_{min} [mm]	100	100	100	130	140				
Min. edge distance	c_{min} [mm]	50	50	60	60	75				
	Tensile N_{Rd}									
	Non-cracked concrete									
	[kN]	7,4	10,2	12,3	9,1	14,7				
	Cracked concrete									
[kN]	5,3	7,3	8,8	6,5	10,5					
	Shear V_{Rd}, without lever arm									
	Non-cracked concrete									
	[kN]	4,6	4,9	6,4	6,3	9,0				
	Cracked concrete									
[kN]	3,2	3,5	4,5	4,5	6,4					

Double anchor, no edge effects, min. spacing ($s = s_{min}$),
(load values are valid for one anchor)

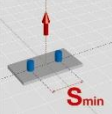
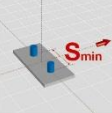
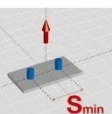
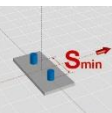
		Data according ETA-13/1038, issue 2014-09-19.									
Anchor size		8			10			14			
Type	HUS3	H, C			H, C			H			
Nominal anchorage depth	h_{nom} [mm]	50	60	70	55	75	85	65	85	115	
Min. base material thickness	h_{min} [mm]	100	100	120	100	130	140	120	160	200	
Min. spacing	s_{min} [mm]	40	50	50	50	50	60	60	75	75	
		Tensile N_{Rd}									
		Non-cracked concrete									
		[kN]	5,7	7,2	8,9	6,3	9,6	11,8	7,9	12,5	18,8
		Cracked concrete									
[kN]	4,0	5,1	6,3	4,5	6,9	8,4	5,6	8,9	13,4		
		Shear V_{Rd}, without lever arm									
		Non-cracked concrete									
		[kN]	5,7	11,3	11,3	6,3	18,7	18,7	16,4	25,0	30,0
		Cracked concrete									
[kN]	4,0	10,3	11,3	4,5	13,8	17,1	11,7	17,8	26,9		
		Hilti Tech. Data									
Anchor size		10			14						
Type	HUS3	HF			HF						
Nominal anchorage depth	h_{nom} [mm]	55	75	85	65	85					
Min. base material thickness	h_{min} [mm]	100	100	100	130	140					
Min. spacing	s_{min} [mm]	50	50	60	60	75					
		Tensile N_{Rd}									
		Non-cracked concrete									
		[kN]	6,3	9,6	11,8	7,9	12,5				
		Cracked concrete									
[kN]	4,5	6,9	8,4	5,6	8,9						
		Shear V_{Rd}, without lever arm									
		Non-cracked concrete									
		[kN]	6,3	16,3	16,3	16,4	25,0				
		Cracked concrete									
[kN]	4,5	13,8	16,3	11,7	17,8						

Fire resistance

Basic loading data for concrete C20/25 – C50/60

All data in this section applies to:

- Correct setting (see setting instruction)
- No edge distance and spacing influence
- Minimum base material thickness
- HUS3-H only.

The following technical data are based on: ETA-13/1038 issue 2014-09-19.

Recommended loads under fire exposure

Anchor size	HUS3 H	8			10			14			
		h_{nom1}	h_{nom2}	h_{nom3}	h_{nom1}	h_{nom2}	h_{nom3}	h_{nom1}	h_{nom2}	h_{nom3}	
Nominal embedment depth	h_{nom} [mm]	50	60	70	55	75	85	65	85	115	
Steel failure for tension and shear load ($F_{Rec,s,fi} = N_{Rec,s,fi} = V_{Rec,s,fi}$)											
Recommended tensile and shear load	R30	$F_{Rec,s,fi}$ [kN]	2,3	2,5	2,7	4,4	4,4	7,4	7,6		
	R60	$F_{Rec,s,fi}$ [kN]	1,7	1,9	2,0	3,3	3,4	5,6	5,8		
	R90	$F_{Rec,s,fi}$ [kN]	1,1	1,1	1,4	2,2	2,3	3,8	3,9		
	R120	$F_{Rec,s,fi}$ [kN]	0,9	0,9	1,1	1,7	1,8	2,9	3,1		
	R30	$M^0_{Rec,s,fi}$ [Nm]	10,4	11,4	12,3	25,1	25,4	56,4	57,0		
	R60	$M^0_{Rec,s,fi}$ [Nm]	7,9	8,4	9,3	19,0	19,4	42,6	43,4		
	R90	$M^0_{Rec,s,fi}$ [Nm]	5,3	5,3	6,3	12,9	13,3	28,7	29,8		
	R120	$M^0_{Rec,s,fi}$ [Nm]	4,1	3,8	4,9	9,8	10,3	21,9	22,9		
Pull-out failure											
Recommended resistance	R30	$N_{Rec,p,fi}$ [kN]	1,1	1,6	2,1	1,7	2,9	3,5	2,2	3,4	5,6
	R60										
R90											
	R120	$N_{Rec,p,fi}$ [kN]	0,9	1,3	1,7	1,4	2,3	2,8	1,8	2,7	4,5
Concrete cone failure											
Characteristic resistance	R30	$N^0_{Rec,c,fi}$ [kN]	1,3	1,9	2,9	1,4	3,4	4,7	2,1	4,6	10,3
	R60										
	R90										
	R120	$N^0_{Rec,c,fi}$ [kN]	1,0	1,5	2,3	1,1	2,7	3,8	1,7	3,6	8,2
Edge distance											
	R30 to R120	$c_{cr,N}$ [mm]	2 h_{ef}								
Anchor spacing											
	R30 to R120	$s_{cr,N}$ [mm]	4 h_{ef}								
Concrete pry-out failure											
	R30 to R120	k [-]	1,0	2,0	1,0	2,0					

- a) The recommended loads under fire exposure include a safety factor for resistance under fire exposure $\gamma_{M,fi} = 1,0$ and the partial safety factor for action $\gamma_{F,fi} = 1,0$. The partial safety factors for action shall be taken from national regulations.

Seismic design

Basic loading data for concrete C20/25 – C50/60

All data in this section applies to:

- Seismic design according to TR045
- HUS3-H and HUS3-C only

The following technical data are based on: ETA-13/1038 issue 2014-09-19.

Anchorage depth range

Anchor size		8	10	14
Type	HUS3	H, C	H, C	H
Nominal anchorage depth range	h_{nom} [mm]	70	85	115

Tension resistance in case of seismic performance category C1

Anchor size		8	10	14
Type	HUS3	H, C	H, C	H
Characteristic tension resistance to steel failure				
	$N_{RK,s,seis}$ [kN]	39,2	62,2	96,6
Partial safety factor	$\gamma_{Ms,seis}$ [-]	1,4		
Characteristic pull-out resistance in cracked concrete C20/25 to C50/60				
	$N_{RK,p,seis}$ [kN]	12	19,8	31,7
Partial safety factor	$\gamma_{Mp,seis}$ [-]	1,5		
Concrete cone resistance and splitting resistance				
Partial safety factor	$\gamma_{Mc,seis} = \gamma_{Msp,seis}$ [-]	1,5		

Displacement under tension load in case of seismic performance category C1 ¹⁾

Anchor size		8	10	14
Type	HUS3	H, C	H, C	H
Displacement	$\delta_{N,seis}$ [mm]	0,6	0,9	1,3

1) Maximum displacement during cycling (seismic event).

Shear resistance in case of seismic performance category C1 ¹⁾

Anchor size		8	10	14
Type	HUS3	H, C	H, C	H
Characteristic shear resistance to steel failure				
	$V_{RK,s,seis}$ [kN]	11,9	16,8	22,5
Partial safety factor	$\gamma_{Ms,seis}$ [-]	1,5		
Concrete pryout resistance and concrete edge resistance				
Partial safety factor	$\gamma_{Mc,seis}$ [-]	1,5		

1) Reduction factor $\alpha_{gap} = 1,0$ when using the Hilti Dynamic Set

Displacement under tension load in case of seismic performance category C1 ¹⁾

Anchor size		8	10	14
Type	HUS3	H, C	H, C	H
Displacement	$\delta_{V,seis}$ [mm]	5,3	4,3	5,5

1) Maximum displacement during cycling (seismic event)

Basic loading data for temporary application in standard and fresh concrete < 28 days old, $f_{ck,cube} \geq 10 \text{ N/mm}^2$:

All data in this section applies to the following conditions:

- Strength class, $f_{ck,cube} \geq 10 \text{ N/mm}^2$
- Only temporary use
- Screw is reusable, before each usage it must be checked according Hilti instruction for use with the suited tube Hilti HRG
- Design resistance and recommended load are valid for single anchor only
- Design resistance as well as the recommended load are valid for all load direction and valid for both cracked and non-cracked concrete
- Minimum base material thickness
- No edge distance and spacing influence
- Valid for HUS3-H only.

a) All data given in this section for HUS3-H sizes 10 and 14 according DIBt approval Z-21.8-2018 issue 2014-04-01

Design resistance

			Hilti Tech. Data			DIBt approval Z-21.8-2018					
Anchor size	HUS3-H		8			10			14		
Nominal embedment depth	h_{nom}	[mm]	50	60	70	55	75	85	65	85	115
Cracked and non-cracked concrete											
Tensile N_{Rd} = Shear V_{Rd}											
	$f_{ck,cube} \geq 10 \text{ N/mm}^2$	[kN]	2,5	3,2	4,7	3,3	5,3	6,3	4,4	7,0	12,3
	$f_{ck,cube} \geq 15 \text{ N/mm}^2$	[kN]	3,1	4,0	5,7	4,0	6,4	7,8	5,4	8,5	15,0
	$f_{ck,cube} \geq 20 \text{ N/mm}^2$	[kN]	3,6	4,6	6,6	4,7	7,4	9,0	6,2	9,9	17,3

Recommended load

			Hilti Tech. Data			DIBt approval Z-21.8-2018					
Anchor size	HUS3-H		8			10			14		
Nominal embedment depth	h_{nom}	[mm]	50	60	70	55	75	85	65	85	115
Tensile N_{rec} = Shear V_{rec}											
	$f_{ck,cube} \geq 10 \text{ N/mm}^2$	[kN]	1,8	2,3	3,4	2,4	3,8	4,5	3,1	5,0	8,8
	$f_{ck,cube} \geq 15 \text{ N/mm}^2$	[kN]	2,2	2,9	4,1	2,9	4,6	5,5	3,8	6,1	10,7
	$f_{ck,cube} \geq 20 \text{ N/mm}^2$	[kN]	2,6	3,3	4,7	3,3	5,3	6,4	4,4	7,1	12,4

a) With overall partial safety factor for action $\gamma = 1,4$. The partial safety factors for action depend on the type of loading and shall be taken from national regulations.

Setting details

			Hilti			DIBt approval Z-21.8-2018					
Anchor size		HUS3-H	8			10			14		
Nominal anchorage depth	h_{nom}	[mm]	50	60	70	55	75	85	65	85	115
Minimum base material thickness	h_{min}	[mm]	100	115	145	115	150	175	130	175	255
Minimum spacing	s_{min}	[mm]	180	225	285	225	300	345	255	345	510
Minimum edge distance direction 1	c_1	[mm]	60	75	95	75	100	115	85	115	170
Minimum edge distance direction 2	c_2	[mm]	95	115	145	115	150	175	130	180	260

Setting details

			Hilti			DIBt approval Z-21.8-2018					
Anchor size		HUS3-H	8			10			14		
Nominal anchorage depth	h_{nom}	[mm]	50	60	70	55	75	85	65	85	115
Nominal diameter of drill bit	d_o	[mm]	8			10			14		
Cutting diameter of drill bit	$d_{cut} \leq$	[mm]	8,45			10,45			14,50		
Depth of drill bit	$h_1 \leq$	[mm]	60	70	80	65	85	95	75	95	125
Diameter of clearance hole in the fixture	$d_f \leq$	[mm]	12			14			18		
Width across	SW	[mm]	13			15			21		
Impact screw driver	Hilti SIW 22 T-A										
Suited tube	Hilti HRG 8			Hilti HRG 10			Hilti HRG 14				

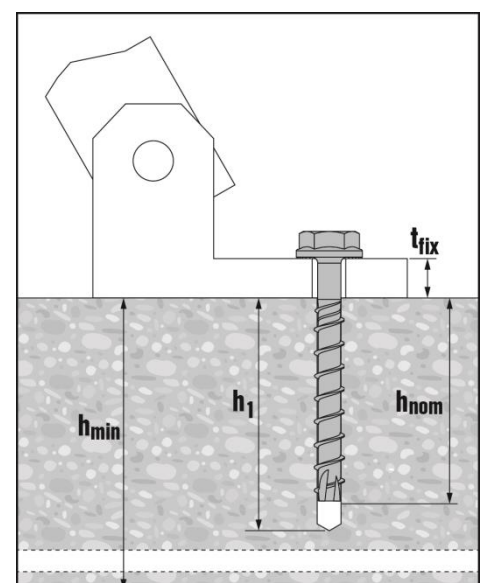
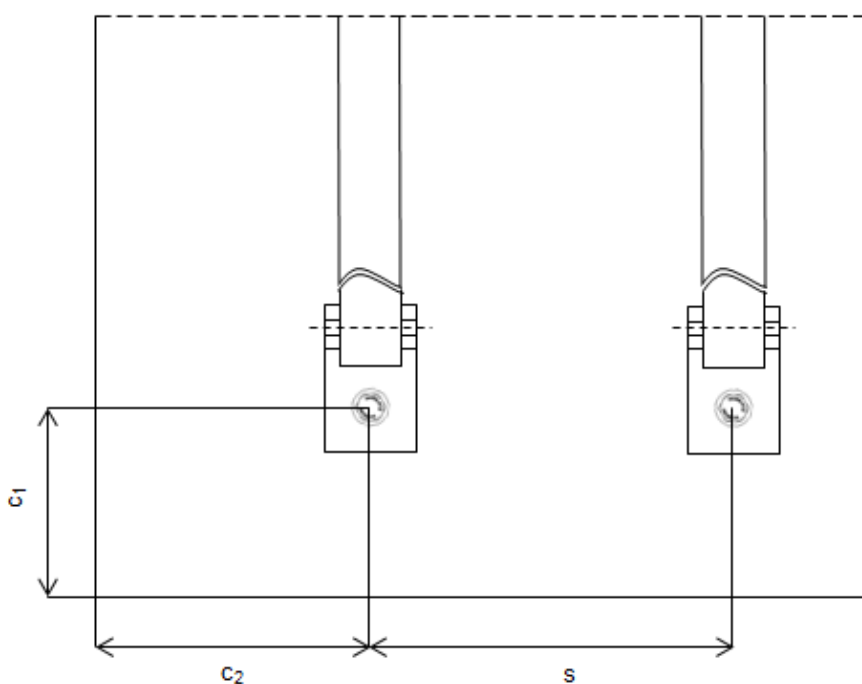

Tube specification

Anchor size / tube		8 / HRG 8	10 / HRG 10	14 / HRG 14
Inner tube diameter	\varnothing_i [mm]	9,7	11,7	16,0
Outer tube diameter	\varnothing_e [mm]	15,0	17,0	22,0
Tube length	Lt [mm]	23,0	28,0	40,3

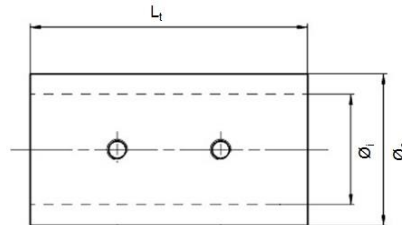

Instruction for use – re-use of screw

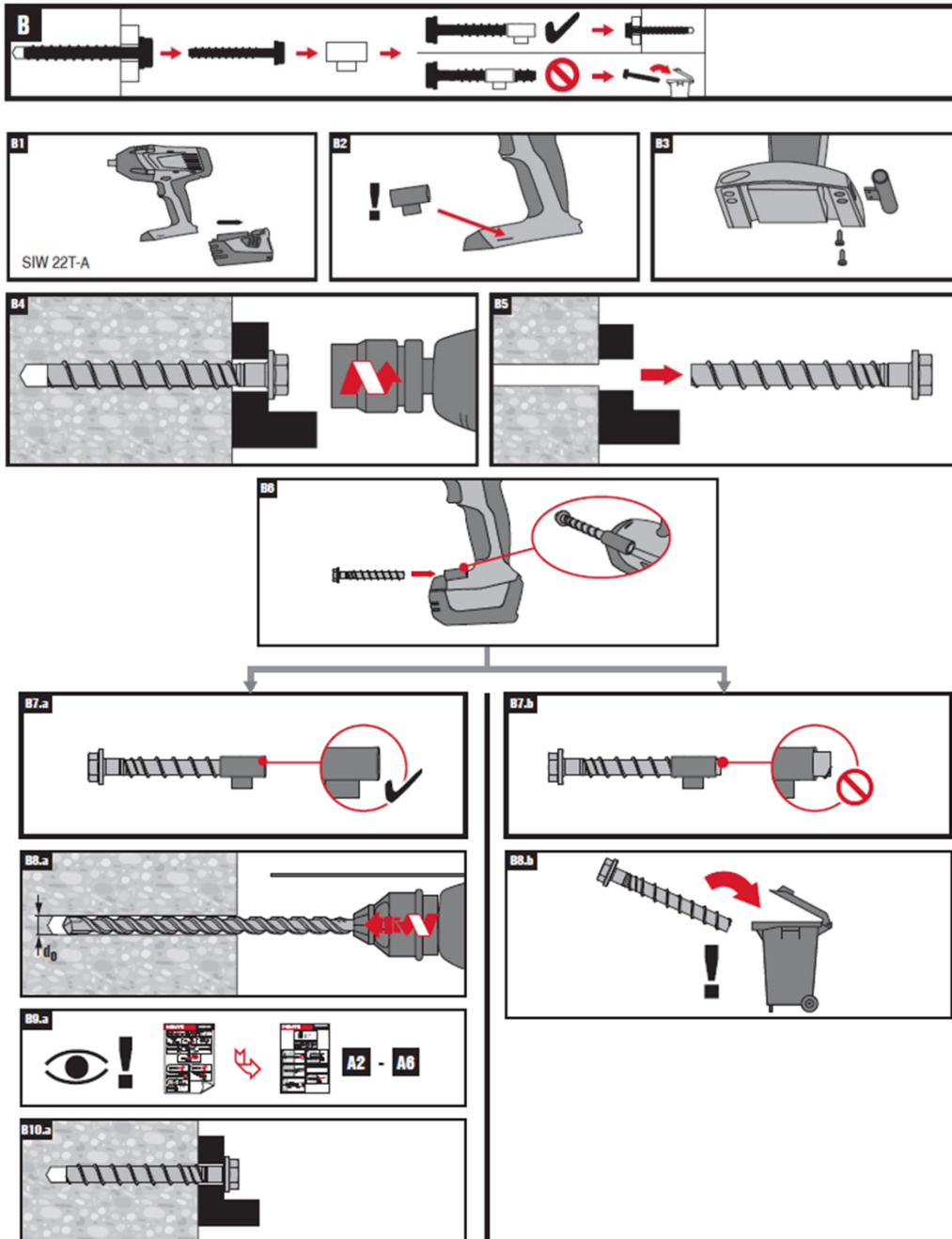

Basic loading data for single anchor in solid masonry units:

All data in this section applies to the following conditions:

Solid bricks: a reduction of the cross section area by a vertical perforation perpendicular to the bed joint area must not be greater than 15%

Drilling:

- Holes in Mz and KS drilled with TE rotary hammers drilled with hammering mode
- Holes in PPW drilled with TE rotary hammers drilled without hammering mode

Installation:

- The anchor is correct mounted, if there is neither a turn-through or spinning of the screw in the drill hole nor that an easy turning of the screw is possible after the installation procedure when the head of the screw has touched the fixture
- The recommended setting tool is Hilti SFH 22A

Edge distance and spacing influences:

- Distance to free edge free edge to solid masonry (Mz and KS) units $c_{min,free} \geq 200$ mm
- Distance to free edge free edge to solid masonry (autoclaved aerated gas concrete) units $c_{min,free} \geq 170$ mm
- The minimum distance to horizontal and vertical mortar joint $c_{min,h}$ and $c_{min,v}$ is stated in drawing below
- Minimum anchor spacing in one brick/block is $s_{min} = 80$ mm

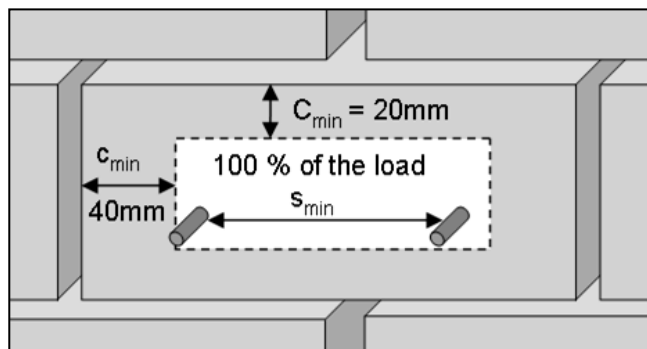

The minimum edge distance to vertical mortar joint for aerated gas concrete is 100mm,

Recommended loads

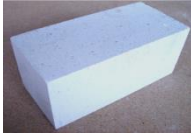
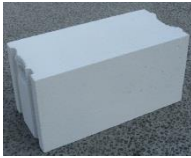
		Hilti		
Base material	Anchor size		8	10
	Type	HUS3	H, C	H, C, HF
	h_{nom}	[mm]	60	75
	Compressive strength class	[N/mm ²]	$F_{rec}^{a)}$ [kN] Tensile and Shear	
 <p>Solid clay brick Mz 2,0-2DF DIN V 105-100 / EN 771-1 l [mm]: 240x115x113 h_{min} [mm]: 115</p>	≥ 12		1,1	1,4
	≥ 20		1,6	2,0
 <p>Solid sand-lime brick KS 2,0-2DF DIN V 106-100 / EN 771-2 LxWxH [mm]: 240x115x113 h_{min} [mm]: 115</p>	≥ 12		1,3	1,4
	≥ 20		1,7	2,1
 <p>Aerated concrete PPW 6-0,4 DIN 4165 / EN 771-4 LxWxH [mm]: 499x240x249 h_{min} [mm]: 240</p>	≥ 6		0,7	0,9

a) Characteristic resistance for tension, shear or combined tension and shear loading.
The characteristic resistance is valid for single anchor or for a group of two or four anchors with spacing equal or larger than the minimum spacing s_{min} according to specification.

Load values:

- The technical data for the HUS3 anchors are reference loads for MZ 12 2,0-2DF, KS 12 2,0-2DF and PPW 6-0,4.
- The load Values are valid for non-structural applications.
- Due to the natural variation of stone solid bricks, on site anchor testing is recommended to validate technical data.
- The HUS3 anchor was installed and tested in the center area of solid bricks as shown considering minimal edge and space distances.
- The HUS3 anchor was not tested in the mortar joint between solid bricks or in hollow bricks; however a load reduction is expected.
- For brick walls where anchor position in brick cannot be determined, 100% anchor testing is recommended.

Limitations of loads:

- All data is for redundant fastening for not structural applications
- Plaster, graveling, lining or leveling courses are regarded as non-bearing and may not be taken into account for the calculation of embedment depth,
- The decisive resistance to tension loads is the lower value of N_{rec} (brick breakout, pull out) and $N_{max,pb}$ (pull out of one brick),

Pull out of one brick:

The allowable load of an anchor or a group of anchors in case of single brick pull out, $N_{max,pb}$ [kN], is given in the following tables:

Clay bricks:

	$N_{max,pb}$ [kN]	brick breadth b_{brick} [mm]					
		80	120	200	240	300	360
brick length l_{brick} [mm]	240	1,1	1,6	2,7	3,3	4,1	4,9
	300	1,4	2,1	3,4	4,1	5,1	6,2
	500	2,3	3,4	5,7	6,9	8,6	10,3

All other brick types:

	$N_{max,pb}$ [kN]	brick breadth b_{brick} [mm]					
		80	120	200	240	300	360
brick length l_{brick} [mm]	240	0,8	1,2	2,1	2,5	3,1	3,7
	300	1,0	1,5	2,6	3,1	3,9	4,6
	500	1,7	2,6	4,3	5,1	6,4	7,7

$N_{max,pb}$ = resistance for pull out of one brick

l_{brick} = length of the brick

b_{brick} = breadth of the brick

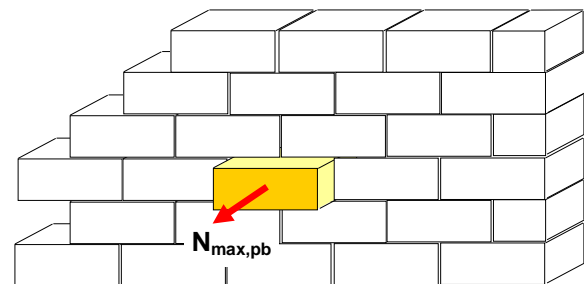
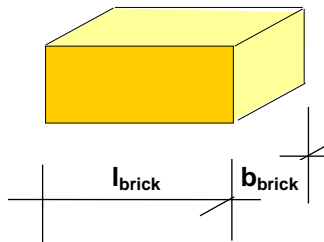

Basic loading data for single anchor in Hollow core slab:

Basic loading data

All data in this section applies to

- Correct setting (See setting instruction)
- No edge distance and spacing influence
- Ratio core width / web thickness $w/e \leq 4,2$
- Concrete C 30/37 to C 50/60

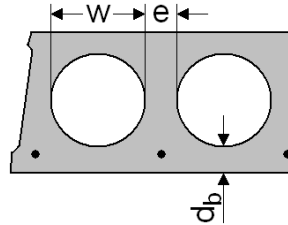

Characteristic resistance

Anchor size			8	10
Type	HUS3		C, H	C, H, HF
Bottom flange thickness	$d_b \geq$	[mm]	30	30
All load directions	F_{Rk}	[kN]	2,0	2,0

Design resistance

Anchor size			8	10
Type	HUS3		C, H	C, H, HF
Bottom flange thickness	$d_b \geq$	[mm]	30	30
All load directions	F_{Rd}	[kN]	1,3	1,3

Recommended loads

Anchor size			8	10
Type	HUS3		C, H	C, H, HF
Bottom flange thickness	$d_b \geq$	[mm]	30	30
All load directions ^{a)}	F_{rec}	[kN]	0,95	0,95

a) With overall partial safety factor for action $\gamma = 1,4$. The partial safety factors for action depend on the type of loading and shall be taken from national regulations.

Requirements for redundant fastening

The definition of redundant fastening according to Member States is given in the ETAG 001 Part six, Annex 1, In Absence of a definition by a Member State the following default values may be taken

Minimum number of fixing points	Minimum number of anchors per fixing point	Maximum design load of action N_{Sd} per fixing point ^{a)}
3	1	2 kN
4	1	3 kN

a) The value for maximum design load of actions per fastening point N_{Sd} is valid in general that means all fastening points are considered in the design of the redundant structural system. The value N_{Sd} may be increased if the failure of one (= most unfavourable) fixing point is taken into account in the design (serviceability and ultimate limit state) of the structural system e.g. suspended ceiling.

Setting

Anchor size		8	10
Type	HUS3	C, H	C, H, HF
Rotary hammer		Hilti TE 6 / TE 7	
drill bit		TE-CX 4	
Impact screw driver		SIW 22 A, 1 st or 2 nd gear	

Setting instruction

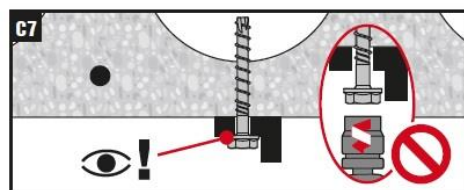
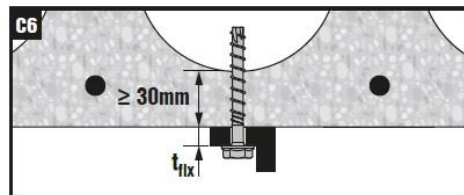
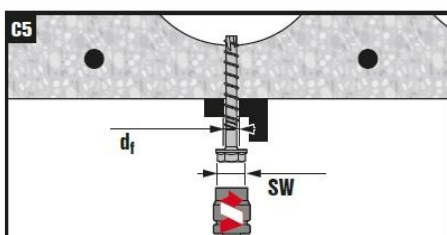
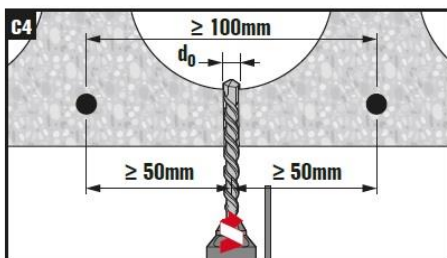
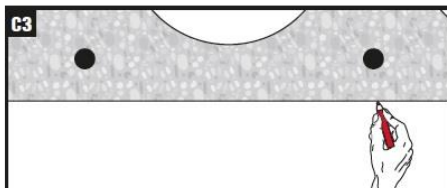
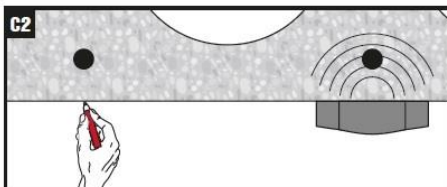
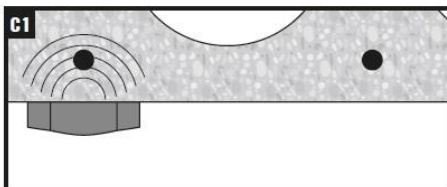
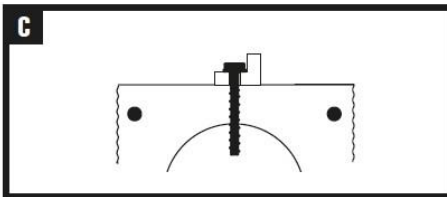

Setting details

Anchor size			8	10
Type	HUS3		C, H	C, H, HF
Nominal embedment depth	$h_{nom} \geq$	[mm]	40	45
Bottom flange thickness	$d_b \geq$	[mm]	30	30
Nominal diameter of drill bit	d_o	[mm]	8	10
Cutting diameter of drill bit	$d_{cut} \leq$	[mm]	8,45	10,45
Nominal depth of drill hole ^{a)}	$h_1 \geq$	[mm]	40	40
Diameter of clearance hole in the fixture	$d_f \leq$	[mm]	12	14
Nominal effective anchorage depth	h_{ef}	[mm]	30	30
Distance between anchor position and prestressing steel	$a_p \geq$	[mm]	50	50

a) Nominal depth of drill hole may be deeper than bottom flange thickness

Type	Size [mm]	Length [mm]	$d_b=30$ [mm]		$d_b=35$ [mm]		$d_b=40$ [mm]		$d_b=50$ [mm]	
			$t_{fix,min}$ [mm]	$t_{fix,max}$ [mm]	$t_{fix,min}$ [mm]	$t_{fix,max}$ [mm]	$t_{fix,min}$ [mm]	$t_{fix,max}$ [mm]	$t_{fix,min}$ [mm]	$t_{fix,max}$ [mm]
HUS3-H	8	55	5	15	5	10	5	5	5	5
		65	5	25	5	20	5	15	5	5
		75	5	35	5	30	5	25	5	15
		85	15	45	15	40	15	35	15	25
		100	30	60	30	55	30	50	30	40
		120	50	80	50	75	50	70	50	60
		150	80	110	80	105	80	100	80	90
HUS3-C	8	65	15	25	15	20	15	15	15	5
		75	15	35	15	30	15	25	15	15
		85	15	45	15	40	15	35	15	25
HUS3-H	10	60	5	15	5	10	5	5	5	5
		70	15	25	15	20	15	15	15	5
		80	5	35	5	30	5	25	5	15
		90	5	45	5	40	5	35	5	25
		100	15	55	15	50	15	45	15	35
		110	25	65	25	60	25	55	25	45
		130	45	85	45	80	45	75	45	65
HUS3-HF	10	60	5	15	5	10	5	5	5	5
		80	5	35	5	30	5	25	5	15
		100	15	55	15	50	15	45	15	35
		110	25	65	25	60	25	55	25	45
HUS3-C	10	70	15	25	15	20	15	15	15	10
		90	15	45	15	40	15	35	15	25
		100	15	55	15	50	15	45	15	35

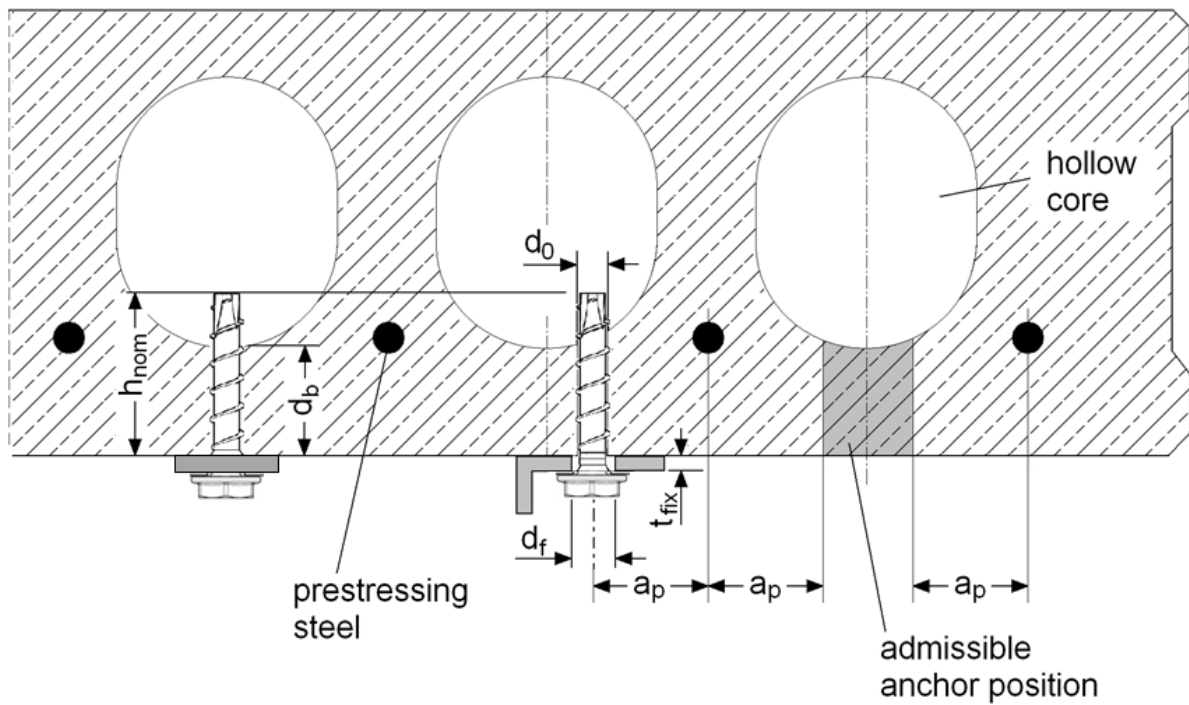

Anchor spacing and edge distance

Anchor size			8	10
Type	HUS3		C, H	C, H, HF
Minimum edge distance	$c_{min} \geq$	[mm]	100	
Minimum anchor spacing	$s_{min} \geq$	[mm]	100	
Minimum distance between anchor groups	$a_{min} \geq$	[mm]	100	

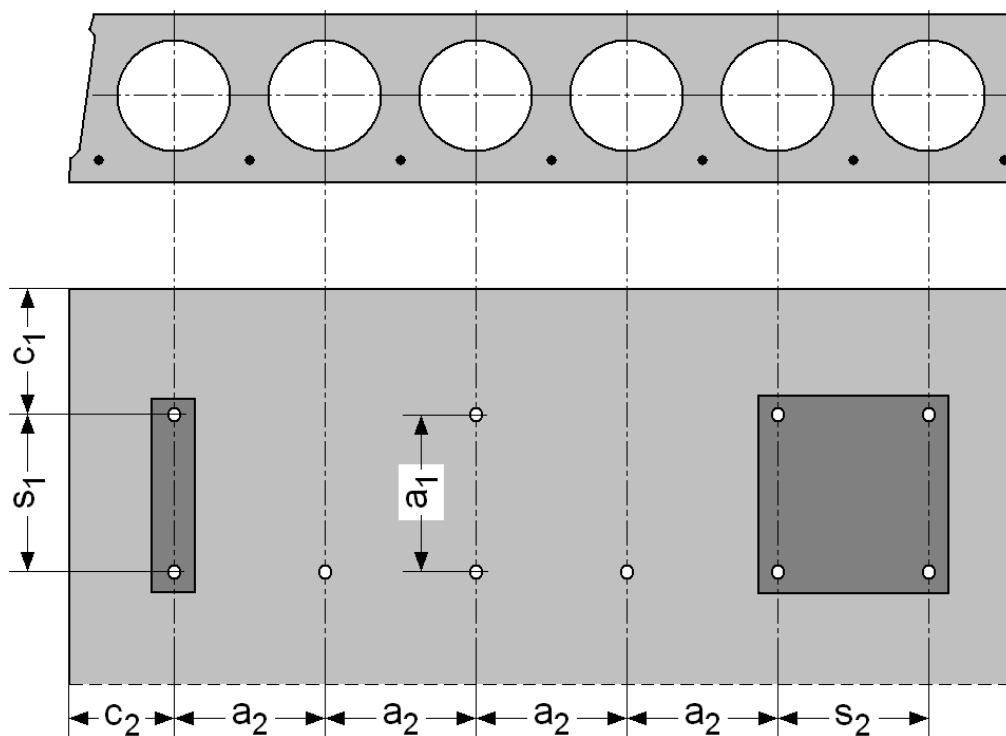

HUS-HR, CR Screw anchor, stainless steel

	Anchor version	Benefits
	HUS-HR 6 / 8 / 10 / 14 Stainless steel concrete Screw with hexagonal head	- High productivity – less drilling and fewer operations than with conventional anchors - ETA approval for cracked and non-cracked concrete - Seismic approval ETA C1
	HUS-CR 10 Stainless steel concrete screw with countersunk head	- Small edge and spacing distances



Concrete



Tensile
zone

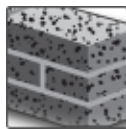

Solid brick

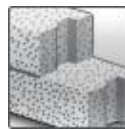

Autoclaved
aerated
concrete



Seismic
ETA-C1

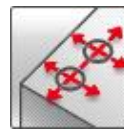

Small edge
distance
and spacing



Fire
resistance

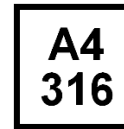

Corrosion
Resistance



Sprinkler
approved



European
Technical
Approval



CE
conformity



PROFIS
Anchor
design
software

Approvals / certificates

Description	Authority / Laboratory	No, / date of issue
European technical approval ^{a)}	DIBt, Berlin	ETA-08/0307 / 2014-04-29
Fire test report	DIBt, Berlin	ETA-08/0307 / 2014-04-29
Fire test report ZTV – Tunnel (EBA)	MFPA, Leipzig	PB III / 08-354 / 2008-11-27

a) Data for HUS-HR with standard and reduced embedment depth is given in this section according ETA-08/0307 issue 2014-04-29,

Basic loading data

All data in this section applies to

- Correct setting (See setting instruction)
- No edge distance and spacing influence
- Concrete as specified in the table
- Steel failure
- Minimum base material thickness
- Concrete C 20/25, $f_{ck,cube} = 25 \text{ N/mm}^2$

For details see Simplified design method

Mean ultimate resistance

		Non-cracked concrete				Cracked concrete			
Anchor size		6	8	10	14	6	8	10	14
Type	HUS	HR	HR	HR,CR	HR	HR	HR	HR,CR	HR
Extra reduced embedment (Hilti Tech Data)									
h_{nom}	[mm]	30	50	60	-	30	50	60	-
Tensile $N_{Ru,m}$	[kN]	- ^{a)}	12,0	16,0	-	- ^{a)}	6,7	10,0	-
Shear $V_{Ru,m}$	[kN]	- ^{a)}	31,5	41,9	-	- ^{a)}	22,5	30,0	-
Reduced embedment (ETA-08/0307)									
h_{nom}	[mm]	-	60	70	70	-	60	70	70
Tensile $N_{Ru,m}$	[kN]	-	16,0	21,3	25,2	-	8,0	12,0	16,0
Shear $V_{Ru,m}$	[kN]	-	34,7	44,0	50,4	-	30,9	38,1	36,0
Standard embedment (ETA-08/0307)									
h_{nom}	[mm]	55	80	90	110	55	80	90	110
Tensile $N_{Ru,m}$	[kN]	12,0	21,3	33,3	53,6	6,7	16,0	21,3	33,3
Shear $V_{Ru,m}$	[kN]	22,7	34,7	44,0	102,7	21,7	34,7	44,0	76,6

a) Please refer to resistance table in all load directions for multiple use fastenings in section HUS 6 screw anchor for redundant fastening,

Characteristic resistance

		Non-cracked concrete				Cracked concrete			
Anchor size		6	8	10	14	6	8	10	14
Type	HUS	HR	HR	HR,CR	HR	HR	HR	HR,CR	HR
Extra reduced embedment (Hilti Tech Data)									
h_{nom}	[mm]	30	50	60	-	30	50	60	-
Tensile N_{Rk}	[kN]	- ^{a)}	9,0	12,0	-	- ^{a)}	5,0	7,5	-
Shear V_{Rk}	[kN]	- ^{a)}	23,6	31,4	-	- ^{a)}	16,9	22,5	-
Reduced embedment (ETA-08/0307)									
h_{nom}	[mm]	-	60	70	70	-	60	70	70
Tensile N_{Rk}	[kN]	-	12,0	16,0	18,9	-	6,0	9,0	12,0
Shear V_{Rk}	[kN]	-	26,0	33,0	37,8	-	23,2	28,6	27,0
Standard embedment (ETA-08/0307)									
h_{nom}	[mm]	55	80	90	110	55	80	90	110
Tensile N_{Rk}	[kN]	9,0	16,0	25,0	40,2	5,0	12,0	16,0	25,0
Shear V_{Rk}	[kN]	17,0	26,0	33,0	77,0	16,3	26,0	33,0	57,4

a) Please refer to resistance table in all load directions for multiple use fastenings in section HUS 6 screw anchor for redundant fastening,

Design resistance

		Non-cracked concrete				Cracked concrete			
Anchor size		6	8	10	14	6	8	10	14
Type	HUS	HR	HR	HR,CR	HR	HR	HR	HR,CR	HR
Extra reduced embedment (Hilti Tech Data)									
h_{nom}	[mm]	30	50	60	-	30	50	60	-
Tensile N_{Rd}	[kN]	- ^{a)}	5,0	6,7	-	- ^{a)}	2,8	4,2	-
Shear V_{Rd}	[kN]	- ^{a)}	15,7	21,0	-	- ^{a)}	11,2	15,0	-
Reduced embedment (ETA-08/0307)									
h_{nom}	[mm]	-	60	70	70	-	60	70	70
Tensile N_{Rd}	[kN]	-	6,7	8,9	10,5	-	3,3	5,0	6,7
Shear V_{Rd}	[kN]	-	17,3	22,0	25,2	-	15,5	19,0	18,0
Standard embedment (ETA-08/0307)									
h_{nom}	[mm]	55	80	90	110	55	80	90	110
Tensile N_{Rd}	[kN]	4,3	8,9	13,9	22,3	2,4	6,7	8,9	13,9
Shear V_{Rd}	[kN]	11,3	17,3	22,0	51,3	10,9	17,3	22,0	38,3

a) Please refer to resistance table in all load directions for multiple use fastenings in section HUS 6 screw anchor for redundant fastening,

Recommended loads

		Non-cracked concrete				Cracked concrete			
Anchor size		6	8	10	14	6	8	10	14
Type	HUS	HR	HR	HR,CR	HR	HR	HR	HR,CR	HR
Extra reduced embedment (Hilti Tech Data)									
h_{nom}	[mm]	30	50	60	-	30	50	60	-
Tensile N_{rec} ^{a)}	[kN]	- ^{b)}	3,6	4,8	-	- ^{b)}	2,0	3,0	-
Shear V_{rec} ^{a)}	[kN]	- ^{b)}	11,2	15,0	-	- ^{b)}	8,0	10,7	-
Reduced embedment (ETA-08/0307)									
h_{nom}	[mm]	-	60	70	70	-	60	70	70
Tensile N_{rec} ^{a)}	[kN]	-	4,8	6,3	7,5	-	2,4	3,6	4,8
Shear V_{rec} ^{a)}	[kN]	-	12,4	15,7	18,0	-	11,0	13,6	12,9
Standard embedment (ETA-08/0307)									
h_{nom}	[mm]	55	80	90	110	55	80	90	110
Tensile N_{rec} ^{a)}	[kN]	3,1	6,3	9,9	16,0	1,7	4,8	6,3	9,9
Shear V_{rec} ^{a)}	[kN]	8,1	12,4	15,7	36,7	7,8	12,4	15,7	27,3

a) With overall partial safety factor for action $\gamma = 1,4$, The partial safety factors for action depend on the type of loading and shall be taken from national regulations,

b) Please refer to resistance table in all load directions for multiple use fastenings in section HUS 6 screw anchor for redundant fastening,

Materials

Mechanical properties

Anchor size	6	8	10	14
Type	HUS-HR	HUS-HR	HUS-HR,CR	HUS-HR
Nominal tensile strength f_{uk} [N/mm ²]	1050	870	950	690
Nominal yield strength f_{yk} [N/mm ²]	900	745	815	590
Stressed cross-section A_s [mm ²]	22,9	39,0	55,4	143,1
Moment of resistance W [mm ³]	15	34	58	255
Design bending resistance $M_{Rd,s}$ [Nm]	19	36	66	193

Part	Material
Stainless steel hexagonal head concrete screw	Stainless steel (grade A4)

Anchor dimensions

Dimensions

Anchor version	d_s [mm]	d_k [mm]	A_s [mm ²]
HUS-HR 6	7,6	5,4	22,9
HUS-HR 8	10,1	7,05	39,0
HUS-HR 10	12,3	8,40	55,4
HUS-CR 10	12,3	8,40	55,4
HUS-HR 14	16,6	12,6	143,1

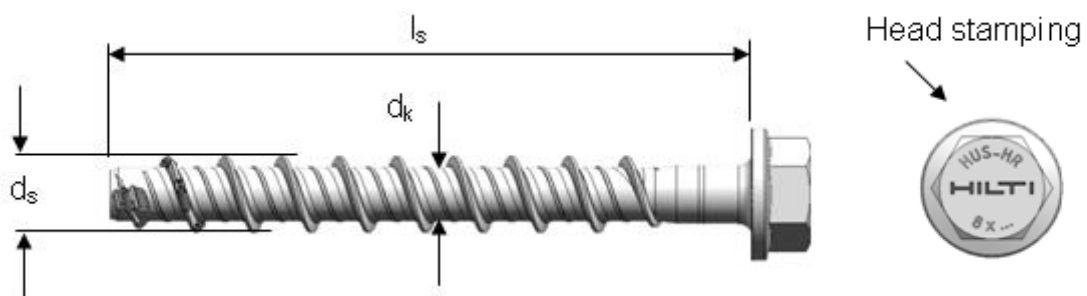

Screw length and thickness of fixture for HUS-HR (hex head)

Anchor size	HUS HR	6		8			10			14	
		h_{nom} 30	h_{nom} 55	h_{nom} 50	h_{nom} 60	h_{nom} 80	h_{nom} 60	h_{nom} 70	h_{nom} 90	h_{nom} 70	h_{nom} 110
Nominal anchorage depth [mm]		Thickness of fixture [mm]									
Length of anchor [mm]		t_{fix1}	t_{fix2}	t_{fix1}	t_{fix2}	t_{fix3}	t_{fix1}	t_{fix2}	t_{fix3}	t_{fix1}	t_{fix2}
35		5	-	-	-	-	-	-	-	-	-
45		15	-	-	-	-	-	-	-	-	-
60		30	5	-	-	-	-	-	-	-	-
65		-	-	15	5	-	5	-	-	-	-
70		40	15	-	-	-	-	-	-	-	-
75		-	-	25	15	-	15	5	-	-	-
80		-	-	-	-	-	-	-	-	10	-
85		-	-	35	25	5	25	15	-	-	-
95		-	-	45	35	15	35	25	5	-	-
105		-	-	55	45	25	45	35	15	-	-
115		-	-	-	-	-	55	45	25	-	-
120		-	-	-	-	-	-	-	-	50	10
130		-	-	-	-	-	70	60	40	-	-
135		-	-	-	-	-	-	-	-	65	25

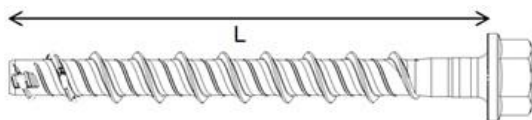

Screw length and thickness of fixture for HUS-CR (countersunk head)

Anchor size	HUS HR	10		
		h_{nom} 60	h_{nom} 70	h_{nom} 90
Nominal anchorage depth [mm]		Thickness of fixture [mm]		
Length of anchor [mm]		t_{fix1}	t_{fix2}	t_{fix3}
75		15	-	-
85		25	15	-
105		45	35	15

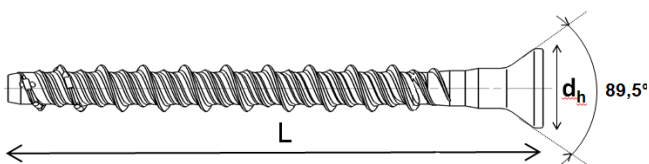

Setting

Recommended installation equipment

Anchor size	HUS	6	8	10	14
Rotary hammer		Hilti TE 2 – TE 30	Hilti TE 2 – TE 30	Hilti TE 2 – TE 30	Hilti TE 2 – TE 30
drill bit		TE-C3X 6/17	TE-C3X 8/17	TE-C3X 10/22	TE-C3X 14/22
Socket wrench insert		S-NSD 13 ½ (L)	S-NSD 13 ½ (L)	S-NSD 15 ½ (L)	S-NSD 21 ½
Torx (CR type only)		-	-	S-SY TX50	-
Impact screw driver	Hilti SIW 14-A, 22-A	Hilti SIW 22 T-A			

Setting instruction

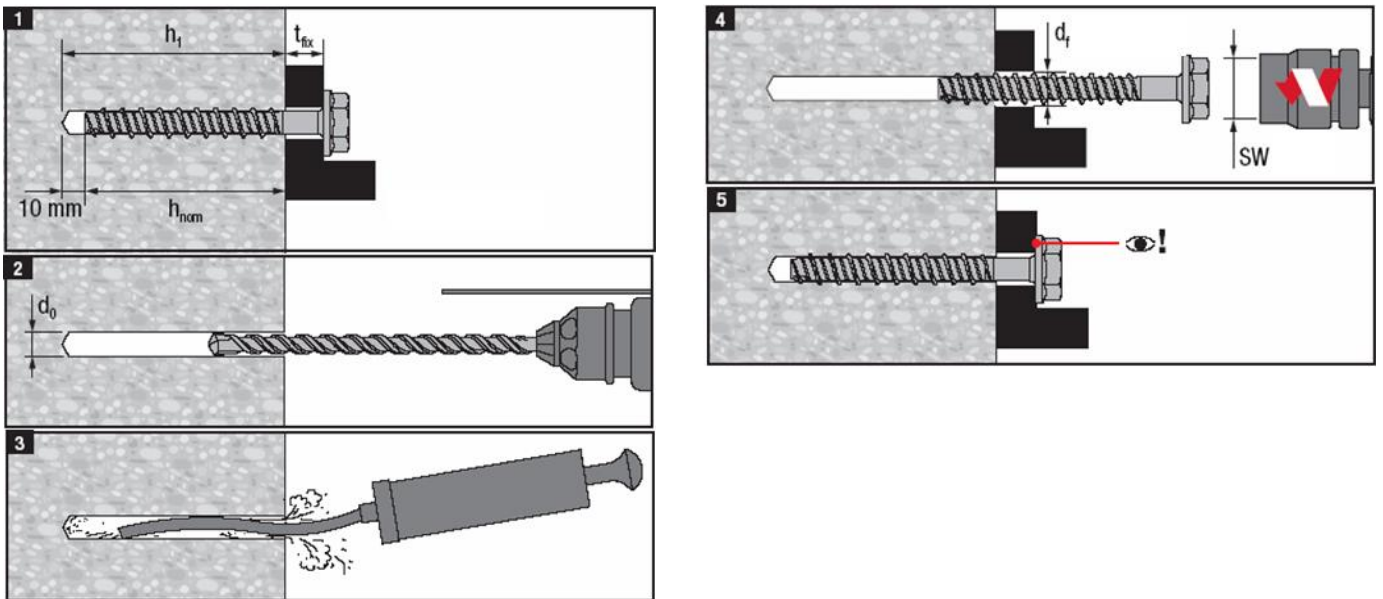

For detailed information on installation see instruction for use given with the package of the product,

Setting details: depth of drill hole h_1 and effective anchorage depth h_{ef}

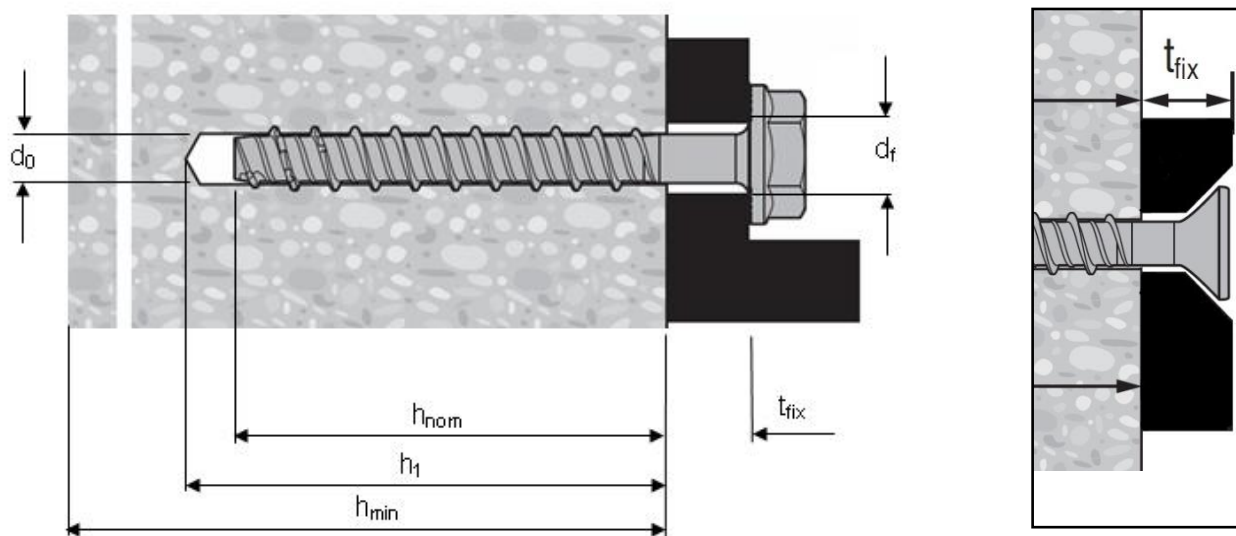

Setting details

Anchor version			6		8			10			14	
Type			HUS		HR			HR, CR ^{a)}			HR	
Nominal embedment depth	h_{nom}	[mm]	30	55	50	60	80	60	70	90	70	110
Nominal diameter of drill bit	d_o	[mm]	6		8			10			14	
Cutting diameter of drill bit	$d_{cut} \leq$	[mm]	6,4		8,45			10,45			14,5	
Depth of drill hole	$h_1 \geq$	[mm]	40	65	60	70	90	70	80	100	80	120
Diameter of countersunk head	d_h	[mm]	-		-			21			-	
Diameter of clearance hole in the fixture	$d_f \leq$	[mm]	9		12			14			18	
Effective anchorage depth	h_{ef}	[mm]	23	45	38	47	64	46	54	71	52	86
Max, installation torque	Concrete	T_{inst} [Nm]	20	- a)	35	- a)	- a)	45 c)			65	
	Solid m, Mz 12	T_{inst} [Nm]	- b)	10	- b)	16	16	-	20	20	- b)	- b)
	Solid m, KS 12	T_{inst} [Nm]	- b)	10	- b)	16	16	-	20	20	- b)	- b)
	Aerated conc,	T_{inst} [Nm]	- b)	4	- b)	8	8	-	10	10	- b)	- b)

- a) Hilti recommends machine setting only in concrete
- b) Hilti does not recommend this setting process for this application,
- c) Intallation torque refer to HUS-HR only

Base material thickness, anchor spacing and edge distance

Anchor size			6		8			10			14	
Type			HUS-HR		HUS-HR			HUS-HR, CR			HUS-HR	
Nominal embedment depth	h_{nom}	[mm]	30	55	50	60	80	60	70	90	70	110
Minimum base material thickness non-cracked concrete	h_{min}	[mm]	100	100	100	100	120	120	120	140	140	160
Minimum spacing	s_{min}	[mm]	35	35	45	45	50	50	50	50	50	60
Minimum edge distance	c_{min}	[mm]	35	35	45	45	50	50	50	50	50	60
Critical spacing for concrete cone and splitting failure	$S_{cr,N} = S_{cr,sp}$	[mm]	69	135	114	141	192	166	194	256	187	310
Critical edge distance for concrete cone and splitting failure	$C_{cr,N} = C_{cr,sp}$	[mm]	35	68	57	71	96	83	97	128	94	155

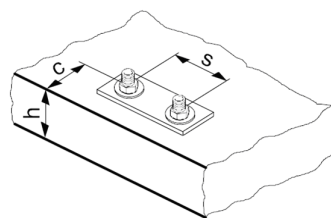

For spacing (edge distance) smaller than critical spacing (critical edge distance) the design loads have to be reduced (see system design resistance),

Critical spacing and critical edge distance for splitting failure apply only for non-cracked concrete, For cracked concrete only the critical spacing and critical edge distance for concrete cone failure are decisive,

Simplified design method

Simplified version of the design method according ETAG 001, Annex C, Design resistance according data given in ETA-08/0307 issue 2011,01,21,

- Influence of concrete strength
- Influence of edge distance
- Influence of spacing
- Valid for a group of two anchors, (The method may also be applied for anchor groups with more than two anchors or more than one edge, The influencing factors must then be considered for each edge distance and spacing, The calculated design loads are then on the save side: They will be lower than the exact values according ETAG 001, Annex C, To avoid this, it is recommended to use the anchor design software PROFIS anchor)

The design method is based on the following simplification:

- No different loads are acting on individual anchors (no eccentricity)

The values are valid for one anchor (single point fastening), multiple use applications are not part of this design method,

For more complex fastening applications please use the anchor design software PROFIS Anchor,

Tension loading

The design tensile resistance is the lower value of

- Steel resistance: $N_{Rd,s}$
- Concrete pull-out resistance: $N_{Rd,p} = N_{Rd,p}^0 \cdot f_B$
- Concrete cone resistance: $N_{Rd,c} = N_{Rd,c}^0 \cdot f_B \cdot f_{1,N} \cdot f_{2,N} \cdot f_{3,N} \cdot f_{re,N}$
- Concrete splitting resistance (only non-cracked concrete): $N_{Rd,sp} = N_{Rd,c}^0 \cdot f_B \cdot f_{1,sp} \cdot f_{2,sp} \cdot f_{3,sp} \cdot f_{re,N}$

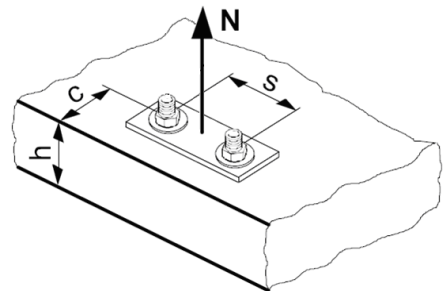

Basic design tensile resistance

Design steel resistance $N_{Rd,s}$

Anchor size		6	8	10	14
Type		HUS-HR	HUS-HR	HUS-HR, CR	HUS-HR
$N_{Rd,s}$	[kN]	17,0	24,3	37,6	73,0

Design pull-out resistance $N_{Rd,p} = N_{Rd,p}^0 \cdot f_B$

Anchor size	Non-cracked concrete				Cracked concrete			
	6	8	10	14	6	8	10	14
Extra reduced embedment (Hilti Tech Data)								
h_{nom} [mm]	30	50	60	-	30	50	60	-
Tensile N_{Rd} [kN]	-	5,0	6,7	-	-	2,8	4,2	-
Reduced embedment								
h_{nom} [mm]	-	60	70	70	-	60	70	70
Tensile N_{Rd} [kN]	-	6,7	8,9	10,5	-	3,3	5,0	6,7
Standard embedment								
h_{nom} [mm]	55	80	90	110	55	80	90	110
Tensile N_{Rd} [kN]	4,3	8,9	13,9	22,3	2,4	6,7	8,9	13,9

Design concrete cone $N_{Rd,c} = N_{Rd,c}^0 \cdot f_B \cdot f_{1,N} \cdot f_{2,N} \cdot f_{3,N} \cdot f_{re,N}$

Design splitting resistance* $N_{Rd,sp} = N_{Rd,c}^0 \cdot f_B \cdot f_{1,sp} \cdot f_{2,sp} \cdot f_{3,sp} \cdot f_{re,N}$

Anchor size	Non-cracked concrete				Cracked concrete			
	6	8	10	14	6	8	10	14
Type	HUS				HR	HR	HR,CR	HR
Extra reduced embedment (Hilti Tech Data)								
h_{nom} [mm]	30	50	60	-	30	50	60	-
$N_{Rd,c}^0$ [kN]	-	6,6	8,7	-	-	4,7	6,2	-
Reduced embedment								
h_{nom} [mm]	-	60	70	70	-	60	70	70
$N_{Rd,c}^0$ [kN]	-	9,0	11,1	10,5	-	6,4	7,9	7,5
Standard embedment								
h_{nom} [mm]	55	80	90	110	55	80	90	110
$N_{Rd,c}^0$ [kN]	7,2	14,3	16,8	22,3	5,2	10,2	12,0	16,0

a) Splitting resistance must only be considered for non-cracked concrete

ETA: Data according ETA-08/0307 issue 2008-12-12 Hilti: Additional Hilti technical data

Influencing factors

Influence of concrete strength

Concrete strength designation (ENV 206)	C 20/25	C 25/30	C 30/37	C 35/45	C 40/50	C 45/55	C 50/60
$f_B = (f_{ck,cube}/25N/mm^2)^{0,5}$ a)	1	1,1	1,22	1,34	1,41	1,48	1,55

a) $f_{ck,cube}$ = concrete compressive strength, measured on cubes with 150 mm side length

Influence of edge distance ^{a)}

$c/c_{cr,N}$	0,1	0,2	0,3	0,4	0,5	0,6	0,7	0,8	0,9	1
$c/c_{cr,sp}$										
$f_{1,N} = 0,7 + 0,3 \cdot c/c_{cr,N} \leq 1$	0,73	0,76	0,79	0,82	0,85	0,88	0,91	0,94	0,97	1
$f_{1,sp} = 0,7 + 0,3 \cdot c/c_{cr,sp} \leq 1$										
$f_{2,N} = 0,5 \cdot (1 + c/c_{cr,N}) \leq 1$	0,55	0,60	0,65	0,70	0,75	0,80	0,85	0,90	0,95	1
$f_{2,sp} = 0,5 \cdot (1 + c/c_{cr,sp}) \leq 1$										

a) The edge distance shall not be smaller than the minimum edge distance c_{min} given in the table with the setting details, These influencing factors must be considered for every edge distance,

Influence of anchor spacing ^{a)}

$s/s_{cr,N}$	0,1	0,2	0,3	0,4	0,5	0,6	0,7	0,8	0,9	1
$s/s_{cr,sp}$										
$f_{3,N} = 0,5 \cdot (1 + s/s_{cr,N}) \leq 1$	0,55	0,60	0,65	0,70	0,75	0,80	0,85	0,90	0,95	1
$f_{3,sp} = 0,5 \cdot (1 + s/s_{cr,sp}) \leq 1$										

a) The anchor spacing shall not be smaller than the minimum anchor spacing s_{min} given in the table with the setting details, This influencing factor must be considered for every anchor spacing,

Influence of base material thickness

h/h_{ef}	2,0	2,2	2,4	2,6	2,8	3,0	3,2	3,4	3,6	$\geq 3,68$
$f_{h,sp} = [h/(2 \cdot h_{ef})]^{2/3}$	1	1,07	1,13	1,19	1,25	1,31	1,37	1,42	1,48	1,5

Influence of reinforcement

Anchor size		6		8			10			14	
Type	HUS	HR		HR			HR, CR			HR	
h_{nom}	[mm]	30	55	50	60	80	60	70	90	70	110
h_{ef}	[mm]	23	45	38	47	64	46	54	71	52	86
$f_{re,N} = 0,5 + h_{ef}/200mm \leq 1$		0,62	0,73	0,69	0,74	0,82	0,73	0,77	0,86	0,76	0,93

a) This factor applies only for dense reinforcement, If in the area of anchorage there is reinforcement with a spacing ≥ 150 mm (any diameter) or with a diameter ≤ 10 mm and a spacing ≥ 100 mm, then a factor $f_{re,N} = 1$ may be applied,

Shear loading

The design shear resistance is the lower value of

- Steel resistance: $V_{Rd,s}$
- Concrete pryout resistance: $V_{Rd,cp} = k \cdot N_{Rd,c}$
- Concrete edge resistance: $V_{Rd,c} = V_{Rd,c}^0 \cdot f_B \cdot f_{\beta} \cdot f_h \cdot f_4 \cdot f_{hef} \cdot f_c$

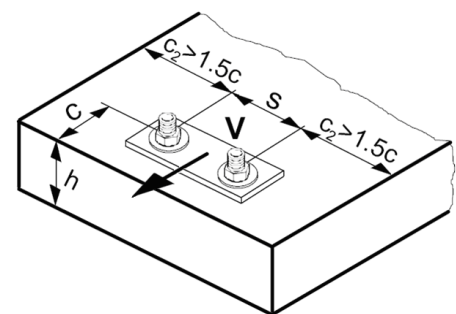

Basic design shear resistance

Design steel resistance $V_{Rd,s}$

Anchor size			6	8	10	14
Type	HUS		HR	HR	HR, CR	HR
Extra reduced embedment	$V_{Rd,s}$	[kN]	11,3	17,3	22,0	-
Reduced embedment	$V_{Rd,s}$	[kN]	-	17,3	22,0	36,7
Standard embedment	$V_{Rd,s}$	[kN]	11,3	17,3	22,0	51,3

Design concrete pryout resistance $V_{Rd,cp} = k \cdot N_{Rd,c}$ ^{a)}

Anchor size		6		8			10			14	
Type	HUS	HR		HR			HR, CR			HR	
h_{nom}	[mm]	30	55	50	60	80	60	70	90	70	110
k		1,0	1,5	2,0							

a) $N_{Rd,c}$: Design concrete cone resistance

Design concrete edge resistance $V_{Rd,c} = V_{Rd,c}^0 \cdot f_B \cdot f_{\beta} \cdot f_h \cdot f_4 \cdot f_{hef} \cdot f_c$

		Non-cracked concrete				Cracked concrete			
Anchor size		6	8	10	14	6	8	10	14
Type	HUS	HR	HR	HR,CR	HR	HR	HR	HR,CR	HR
Extra reduced embedment (Hilti Tech Data)									
h_{nom}	[mm]	30	50	60	-	30	50	60	-
$V_{Rd,c}^0$	[kN]	-	5,9	8,6	-	-	4,2	6,1	-
Reduced embedment									
h_{nom}	[mm]	-	60	70	70	-	60	70	70
$V_{Rd,c}^0$	[kN]	-	5,9	8,6	15	-	4,2	6,1	10,6
Standard embedment									
h_{nom}	[mm]	55	80	90	110	55	80	90	110
$V_{Rd,c}^0$	[kN]	3,6	5,9	8,6	15,1	2,6	4,2	6,1	10,7

Influencing factors

Influence of concrete strength

Concrete strength designation (ENV 206)	C 20/25	C 25/30	C 30/37	C 35/45	C 40/50	C 45/55	C 50/60
$f_B = (f_{ck,cube}/25N/mm^2)^{0,5}$ ^{a)}	1	1,1	1,22	1,34	1,41	1,48	1,55

a) $f_{ck,cube}$ = concrete compressive strength, measured on cubes with 150 mm side length

Influence of angle between load applied and the direction perpendicular to the free edge

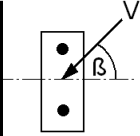
Angle β	0°	10°	20°	30°	40°	50°	60°	70°	80°	≥ 90°
$f_{\beta} = \sqrt{\frac{1}{(\cos \alpha_v)^2 + \left(\frac{\sin \alpha_v}{2,5}\right)^2}}$ 	1	1,01	1,05	1,13	1,24	1,40	1,64	1,97	2,32	2,50

Influence of base material thickness

h/c	0,15	0,3	0,45	0,6	0,75	0,9	1,05	1,2	1,35	≥ 1,5
$f_h = \{h/(1,5 \cdot c)\}^{1/2} \leq 1$	0,32	0,45	0,55	0,63	0,71	0,77	0,84	0,89	0,95	1,00

Influence of anchor spacing and edge distance ^{a)} for concrete edge resistance: f_4

c/h _{ef}	Single anchor	Group of two anchors s/h _{ef}														
		0,75	1,50	2,25	3,00	3,75	4,50	5,25	6,00	6,75	7,50	8,25	9,00	9,75	10,50	11,25
0,50	0,35	0,27	0,35	0,35	0,35	0,35	0,35	0,35	0,35	0,35	0,35	0,35	0,35	0,35	0,35	0,35
0,75	0,65	0,43	0,54	0,65	0,65	0,65	0,65	0,65	0,65	0,65	0,65	0,65	0,65	0,65	0,65	0,65
1,00	1,00	0,63	0,75	0,88	1,00	1,00	1,00	1,00	1,00	1,00	1,00	1,00	1,00	1,00	1,00	1,00
1,25	1,40	0,84	0,98	1,12	1,26	1,40	1,40	1,40	1,40	1,40	1,40	1,40	1,40	1,40	1,40	1,40
1,50	1,84	1,07	1,22	1,38	1,53	1,68	1,84	1,84	1,84	1,84	1,84	1,84	1,84	1,84	1,84	1,84
1,75	2,32	1,32	1,49	1,65	1,82	1,98	2,15	2,32	2,32	2,32	2,32	2,32	2,32	2,32	2,32	2,32
2,00	2,83	1,59	1,77	1,94	2,12	2,30	2,47	2,65	2,83	2,83	2,83	2,83	2,83	2,83	2,83	2,83
2,25	3,38	1,88	2,06	2,25	2,44	2,63	2,81	3,00	3,19	3,38	3,38	3,38	3,38	3,38	3,38	3,38
2,50	3,95	2,17	2,37	2,57	2,77	2,96	3,16	3,36	3,56	3,76	3,95	3,95	3,95	3,95	3,95	3,95
2,75	4,56	2,49	2,69	2,90	3,11	3,32	3,52	3,73	3,94	4,15	4,35	4,56	4,56	4,56	4,56	4,56
3,00	5,20	2,81	3,03	3,25	3,46	3,68	3,90	4,11	4,33	4,55	4,76	4,98	5,20	5,20	5,20	5,20
3,25	5,86	3,15	3,38	3,61	3,83	4,06	4,28	4,51	4,73	4,96	5,18	5,41	5,63	5,86	5,86	5,86
3,50	6,55	3,51	3,74	3,98	4,21	4,44	4,68	4,91	5,14	5,38	5,61	5,85	6,08	6,31	6,55	6,55
3,75	7,26	3,87	4,12	4,36	4,60	4,84	5,08	5,33	5,57	5,81	6,05	6,29	6,54	6,78	7,02	7,26
4,00	8,00	4,25	4,50	4,75	5,00	5,25	5,50	5,75	6,00	6,25	6,50	6,75	7,00	7,25	7,50	7,75
4,25	8,76	4,64	4,90	5,15	5,41	5,67	5,93	6,18	6,44	6,70	6,96	7,22	7,47	7,73	7,99	8,25
4,50	9,55	5,04	5,30	5,57	5,83	6,10	6,36	6,63	6,89	7,16	7,42	7,69	7,95	8,22	8,49	8,75
4,75	10,35	5,45	5,72	5,99	6,27	6,54	6,81	7,08	7,36	7,63	7,90	8,17	8,45	8,72	8,99	9,26
5,00	11,18	5,87	6,15	6,43	6,71	6,99	7,27	7,55	7,83	8,11	8,39	8,66	8,94	9,22	9,50	9,78
5,25	12,03	6,30	6,59	6,87	7,16	7,45	7,73	8,02	8,31	8,59	8,88	9,17	9,45	9,74	10,02	10,31
5,50	12,90	6,74	7,04	7,33	7,62	7,92	8,21	8,50	8,79	9,09	9,38	9,67	9,97	10,26	10,55	10,85

- a) The anchor spacing and the edge distance shall not be smaller than the minimum anchor spacing s_{min} and the minimum edge distance c_{min} .

Influence of embedment depth

Anchor size		6		8			10			14	
Type	HUS	HR		HR			HR, CR			HR	
h _{nom}	[mm]	30	55	50	60	80	60	70	90	70	110
$f_{hef} = 0,05 \cdot (h_{ef} / d)^{1,68}$		-	1,48	0,69	0,98	1,64	0,65	0,85	1,35	0,45	1,06

Influence of edge distance ^{a)}

c/d	4	6	8	10	15	20	30	40
$f_c = (d / c)^{0,19}$	0,77	0,71	0,67	0,65	0,60	0,57	0,52	0,50

- a) The edge distance shall not be smaller than the minimum edge distance c_{min} .

Combined tension and shear loading

For combined tension and shear loading see section “Anchor Design”,

Precalculated values

Design resistance calculated according ETAG 001, Annex C and data given in ETA-08/0307, issue 2011,01,21, All data applies to concrete C 20/25 – $f_{ck,cube} = 25 \text{ N/mm}^2$, Hilti technical data for the extra reduced embedment depth is not part of the approval,

Recommended loads can be calculated by dividing the design resistance by an overall partial safety factor for action $\gamma = 1,4$, The partial safety factors for action depend on the type of loading and shall be taken from national regulations,

Design resistance

Single anchor, no edge effects ($c \geq c_{cr}$), shear without lever arm

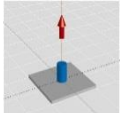
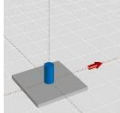
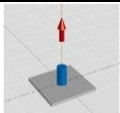
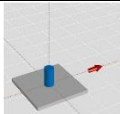
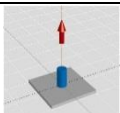
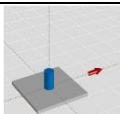
Anchor size			Non-cracked concrete				Cracked concrete			
			6	8	10	14	6	8	10	14
Type	HUS		HR	HR	HR,CR	HR	HR	HR,CR	HR	
Extra reduced embedment (Hilti Tech Data)										
h_{nom}	[mm]		30	50	60	-	30	50	60	-
Min, base material thickness h_{min}		[mm]	80	100	120	-	80	100	120	-
	Tensile N_{Rd}	[kN]	-	5,0	6,7	-	-	2,8	4,2	-
	Shear V_{Rd}	[kN]	-	15,7	21,0	-	-	11,2	15,0	-
Reduced embedment										
h_{nom}	[mm]		-	60	70	70	-	60	70	70
Min, base material thickness h_{min}		[mm]	-	100	120	140	-	100	120	140
	Tensile N_{Rd}	[kN]	-	6,7	8,9	10,5	-	3,3	5,0	6,7
	Shear V_{Rd}	[kN]	-	17,3	22,0	25,2	-	15,5	19,0	18,0
Standard embedment										
h_{nom}	[mm]		55	80	90	110	55	80	90	110
Min, base material thickness h_{min}		[mm]	100	120	140	160	100	120	140	160
	Tensile N_{Rd}	[kN]	4,3	8,9	13,9	22,3	2,4	6,7	8,9	13,9
	Shear V_{Rd}	[kN]	11,3	17,3	22,0	51,3	10,9	17,3	22,0	38,3

Single anchor, min, edge distance ($c = c_{min}$), shear without lever arm

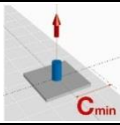
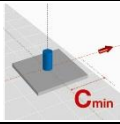
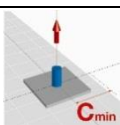
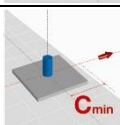
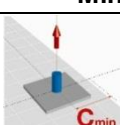
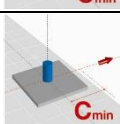
			Non-cracked concrete				Cracked concrete			
Anchor size			6	8	10	14	6	8	10	14
Type	HUS		HR	HR	HR,CR	HR	HR	HR,CR	HR	
Extra reduced embedment (Hilti Tech Data)										
h_{nom}	[mm]		30	50	60	-	30	50	60	-
Min, base material thickness h_{min} [mm]			80	100	120	-	80	100	120	-
Min, edge distance c_{min} [mm]			40	45	50	-	40	45	50	-
	Tensile N_{Rd}	[kN]	-	5,0	6,7	-	-	2,8	4,2	-
	Shear V_{Rd}	[kN]	-	3,8	4,7	-	-	2,7	3,3	-
Reduced embedment										
h_{nom}	[mm]		-	60	70	70	-	60	70	70
Min, base material thickness h_{min} [mm]			-	100	120	140	-	100	120	140
Min, edge distance c_{min} [mm]			-	45	50	50	-	45	50	50
	Tensile N_{Rd}	[kN]	-	6,6	8,0	7,7	-	3,3	5,0	4,9
	Shear V_{Rd}	[kN]	-	3,9	4,8	5,0	-	2,8	3,4	3,6
Standard embedment										
h_{nom}	[mm]		55	80	90	110	55	80	90	110
Min, base material thickness h_{min} [mm]			100	120	140	160	100	120	140	160
Min, edge distance c_{min} [mm]			40	50	50	60	40	50	50	60
	Tensile N_{Rd}	[kN]	4,3	8,9	10,4	13,8	2,4	6,7	6,8	9,0
	Shear V_{Rd}	[kN]	3,2	4,8	5,1	7,1	2,2	3,4	3,6	5,0

Double anchor, no edge effects ($c \geq c_{cr}$), min, spacing ($s = s_{min}$), shear without lever arm
(load values are valid for one anchor)

			Non-cracked concrete				Cracked concrete			
Anchor size			6	8	10	14	6	8	10	14
Type	HUS		HR	HR	HR,CR	HR	HR	HR,CR	HR	
Extra reduced embedment (Hilti Tech Data)										
h_{nom}	[mm]		30	50	60	-	30	50	60	-
Min, base material thickness h_{min} [mm]			80	100	120	-	80	100	120	-
Min, spacing s_{min} [mm]			40	45	50	-	40	45	50	-
	Tensile N_{Rd}	[kN]	-	4,6	6,0	-	-	3,3	4,3	-
	Shear V_{Rd}	[kN]	-	11,0	14,3	-	-	7,8	10,2	-
Reduced embedment										
h_{nom}	[mm]		-	60	70	70	-	60	70	70
Min, base material thickness h_{min} [mm]			-	100	120	140	-	100	120	140
Min, spacing s_{min} [mm]			-	45	50	50	-	45	50	50
	Tensile N_{Rd}	[kN]	-	6,0	7,3	6,9	-	4,3	5,2	5,0
	Shear V_{Rd}	[kN]	-	14,3	17,5	16,7	-	10,2	12,5	11,9
Standard embedment										
h_{nom}	[mm]		55	80	90	110	55	80	90	110
Min, base material thickness h_{min} [mm]			100	120	140	160	100	120	140	160
Min, spacing s_{min} [mm]			40	50	50	60	40	50	50	60
	Tensile N_{Rd}	[kN]	4,7	9,1	10,4	13,8	3,4	6,5	7,4	9,8
	Shear V_{Rd}	[kN]	9,9	17,3	22,0	33,1	7,0	15,5	17,7	23,6

Fire resistance

Basic loading data for concrete C20/25 – C50/60

All data in this section applies to:

- Correct setting (see setting instruction)
- No edge distance and spacing influence
- Minimum base material thickness

The following technical data are based on: ETA-08/0307 issue 2014-04-29

Characteristic loads under fire exposure

Anchor Size		6	8		10		14		
Type	HUS	HR	HR		HR, CR		HR, CR		
		h_{nom}	h_{nom}	h_{nom}	h_{nom}	h_{nom}	h_{nom}	h_{nom}	
Nominal embedment depth	h_{nom} [mm]	50	60	80	70	90	70	110	
Steel failure for tension and shear load ($F_{Rec,s,fi} = N_{Rec,s,fi} = V_{Rec,s,fi}$)									
Recommended tensile and shear load	R30	$F_{Rec,s,fi}$ [kN]	2,3	4,4	8,8	19,9			
	R60	$F_{Rec,s,fi}$ [kN]	1,6	3,0	5,7	12,8			
	R90	$F_{Rec,s,fi}$ [kN]	0,9	1,5	2,6	5,8			
	R120	$F_{Rec,s,fi}$ [kN]	0,5	0,8	1,1	2,6			
	R30	$M^0_{Rec,s,fi}$ [Nm]	1,9	3,9	9,2	31,2			
	R60	$M^0_{Rec,s,fi}$ [Nm]	1,3	2,6	6,0	20,2			
	R90	$M^0_{Rec,s,fi}$ [Nm]	0,7	1,3	2,7	9,1			
	R120	$M^0_{Rec,s,fi}$ [Nm]	0,4	0,7	1,2	4,0			
Pull out failure									
Recommended resistance	R30	$N_{Rec,p,fi}$ [kN]	0,6	0,7	1,4	1,1	1,9	1,4	3,0
	R60								
	R90								
	R120	$N_{Rec,p,fi}$ [kN]	0,5	0,6	1,1	0,9	1,5	1,1	2,4
Concrete cone failure									
Edge distance									
	R30 to R120	$c_{cr,N}$ [mm]	$2h_{ef}$						
Spacing									
	R30 to R120	$s_{cr,N}$ [mm]	$4h_{ef}$						
Concrete pry-out failure									
	R30 to R120	k [-]	1,5	2,0	2,0	2,0			

b) The recommended loads under fire exposure include a safety factor for resistance under fire exposure $\gamma_{M,fi} = 1,0$ and the partial safety factor for action $\gamma_{F,fi} = 1,0$. The partial safety factors for action shall be taken from national regulations,

Seismic design

Basic loading data for concrete C20/25 – C50/60

All data in this section applies to:

- Seismic design according to TR045

The following technical data are based on: ETA-08/0307 issue 2014-04-30

Anchorage depth range

Anchor size		8	10	14
Type	HUS	HR	HR, CR	HR
Nominal anchorage depth range	h_{nom} [mm]	80	90	110

Tension resistance in case of seismic performance category C1

Anchor size		8	10	14
Type	HUS	HR	HR, CR	HR
Characteristic tension resistance to steel failure				
	$N_{Rk,s,seis}$ [kN]	34,0	52,6	102,2
Partial safety factor	$\gamma_{Ms,seis}$ [-]	1,4		
Characteristic pull-out resistance in cracked concrete C20/25 to C50/60				
	$N_{Rk,p,seis}$ [kN]	7,7	12,5	17,5
Partial safety factor	$\gamma_{Mp,seis}$ [-]	1,8		
Concrete cone resistance and splitting resistance				
Partial safety factor	$\gamma_{Mc,seis} = \gamma_{Msp,seis}$ [-]	1,8		

Displacement under tension load in case of seismic performance category C1 ¹⁾

Anchor size		8	10	14
Type	HUS	HR	HR, CR	HR
Displacement	$\delta_{N,seis}$ [mm]	1,2	1,2	0,4

1) Maximum displacement during cycling (seismic event),

Shear resistance in case of seismic performance category C1 ¹⁾

Anchor size		8	10	14
Type	HUS	HR	HR, CR	HR
Characteristic shear resistance to steel failure				
	$V_{Rk,s,seis}$ [kN]	11,1	17,9	53,9
Partial safety factor	$\gamma_{Ms,seis}$ [-]	1,5		
Concrete pryout resistance and concrete edge resistance				
Partial safety factor	$\gamma_{Mc,seis}$ [-]	1,5		

1) Reduction factor $\alpha_{gap} = 1,0$ when using the Hilti Dynamic Set

Displacement under tension load in case of seismic performance category C1 ¹⁾

Anchor size		8	10	14
Type	HUS	HR	HR, CR	HR
Displacement	$\delta_{V,seis}$ [mm]	4,8	5,3	7,6



1) Maximum displacement during cycling (seismic event)

Basic loading data for single anchor in solid masonry units

All data in this section applies to

- Load values valid for holes drilled with TE rotary hammers in hammering mod
- Correct anchor setting (see instruction for use, setting details)
- The core / material ratio may not exceed 15% of a bed joint area,
- The brim area around holes must be at least 70mm
- Edge distances, spacing and other influences, see below

Recommended loads

Base material		Anchor size Type	Hilti		
			6 HUS-HR	8 HUS-HR	10 HUS-HR, CR
Germany, Austria, Switzerland		h_{nom} [mm]	55	60	70
Solid clay brick Mz12/2,0 	DIN 105/ EN 771-1 $f_b^{a)} \geq 12 \text{ N/mm}^2$	Tensile N_{rec} [kN]	0,9	1,0	1,1
		Shear V_{rec} [kN]	1,4	2,0	2,3
Solid sand-lime brick KS 12/2,0 	DIN 106/ EN 771-2 $f_b^{a)} \geq 12 \text{ N/mm}^2$	Tensile N_{rec} [kN]	0,6	0,6	1,0
		Shear V_{rec} [kN]	0,9	1,1	1,7
Aerated concrete PPW 6-0,4 	DIN 4165/ EN 771-4 $f_b^{a)} \geq 6 \text{ N/mm}^2$	Tensile N_{rec} [kN]	0,2	0,2	0,4
		Shear V_{rec} [kN]	0,4	0,4	0,9

a) f_b = brick strength

Permissible anchor location in brick and block walls

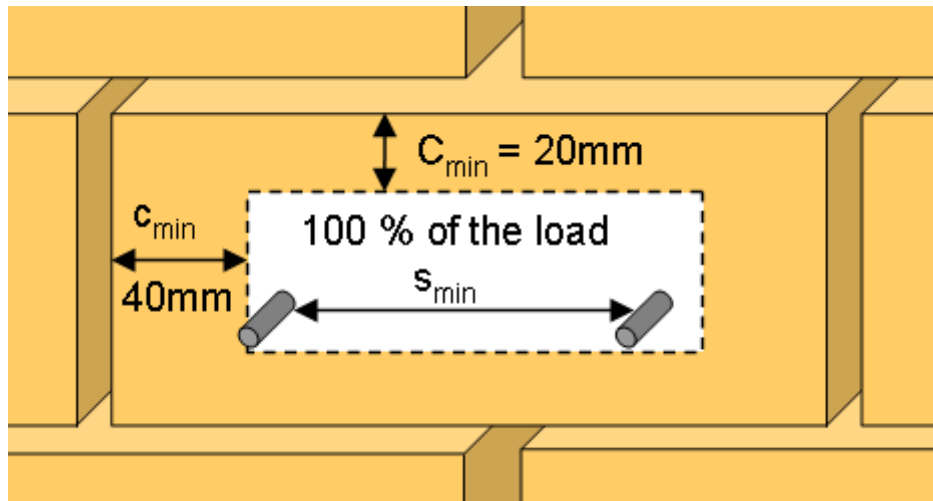

Edge distance and spacing influences

- The technical data for the HUS-HR anchors are reference loads for MZ 12 and KS 12, Due to the large variation of natural stone solid bricks, on site anchor testing is recommended to validate technical data,
- The HUS-HR anchor was installed and tested in center of solid bricks as shown, The HUS-HR anchor was not tested in the mortar joint between solid bricks or in hollow bricks; however a load reduction is expected,
- For brick walls where anchor position in brick can not be determined, 100% anchor testing is recommended,
- Distance to free edge free edge to solid masonry (Mz and KS) units ≥ 200 mm
- Distance to free edge free edge to solid masonry (autoclaved aerated gas concrete) units ≥ 170 mm
- The minimum distance to horizontal and vertical mortar joint (c_{min}) is stated in drawing above,
- Minimum anchor spacing (s_{min}) in one brick/block is $\geq 2 \cdot c_{min}$

Limits

- Applied load to individual bricks may not exceed 1,0 kN without compression or 1,4 kN with compression
- All data is for multiple use for non structural applications
- Plaster, graveling, lining or levelling courses are regarded as non-bearing and may not be taken into account for the calculation of embedment depth,

HUS-V Screw anchor

	Anchor version	Benefits
	HUS-V 8 / 10 Carbon steel concrete screw with hexagonal head	<ul style="list-style-type: none"> - High productivity – less drilling and fewer operations than with conventional anchors - Technical data for cracked and non-cracked concrete - Technical data for reusability in fresh concrete ($f_{ck,cube}=10/15/20$ Nmm²) for temporary applications - Two embedment depths for maximum design flexibility



Concrete



Tensile zone

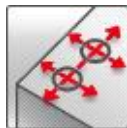

Small edge distance and spacing

Basic loading data (for a single anchor)

All data in this section applies to

- Correct setting (See setting instruction)
- No edge distance and spacing influence
- Steel failure
- Minimum base material thickness
- Cracked and non-cracked Concrete C 20/25, $f_{ck,cube} = 25$ N/mm²
- Adjustment allowed during the installation for size 8 and 10, h_{nom2} only,.

For details see Simplified design method

Mean ultimate resistance

Anchor size	HUS-V	8		10	
		50	65	55	75
Nominal embedment depth h_{nom}	[mm]	50	65	55	75
Non-cracked concrete					
Tensile $N_{Ru,m}$	[kN]	11,9	21,2	11,9	26,6
Shear $V_{Ru,m}$	[kN]	16,4	16,7	18,6	20,5
Cracked concrete					
Tensile $N_{Ru,m}$	[kN]	5,3	11,9	8,0	21,2
Shear $V_{Ru,m}$	[kN]	11,7	16,7	13,2	20,5

Characteristic resistance

Anchor size	HUS-V	8		10	
Nominal embedment depth h_{nom}	[mm]	50	65	55	75
Non-cracked concrete					
Tensile N_{Rk}	[kN]	9,0	16,0	9,0	20,0
Shear V_{Rk}	[kN]	12,3	15,9	14,0	19,5
Cracked concrete					
Tensile N_{Rk}	[kN]	4,0	9,0	6,0	16,0
Shear V_{Rk}	[kN]	8,8	15,9	10,0	19,5

Design resistance

Anchor size	HUS-V	8		10	
Nominal embedment depth h_{nom}	[mm]	50	65	55	75
Non-cracked concrete					
Tensile N_{Rd}	[kN]	5,0	8,9	5,0	9,5
Shear V_{Rd}	[kN]	6,9	10,6	7,8	13,0
Cracked concrete					
Tensile N_{Rd}	[kN]	2,2	5,0	3,3	7,6
Shear V_{Rd}	[kN]	4,9	10,6	5,5	13,0

Recommended load

Anchor size	HUS-V	8		10	
Nominal embedment depth h_{nom}	[mm]	50	65	55	75
Non-cracked concrete					
Tensile N_{Rec}	[kN]	3,6	6,3	3,6	6,8
Shear V_{Rec}	[kN]	4,9	7,6	5,6	9,3
Cracked concrete					
Tensile N_{Rec}	[kN]	1,6	3,6	2,4	5,4
Shear V_{Rec}	[kN]	3,5	7,6	4,0	9,3

a) With overall partial safety factor for action $\gamma = 1,4$, The partial safety factors for action depend on the type of loading and shall be taken from national regulations,

Materials

Mechanical properties

Anchor size	HUS-V	8	10
Nominal tensile strength f_{uk}	[N/mm ²]	880	715
Yield strength f_{yk}	[N/mm ²]	755	610
Stressed cross-section A_s	[mm ²]	36,6	59,4
Moment of resistance W	[mm ³]	35	65
Char, bending resistance $M_{Rk,s}^0$	[Nm]	37,1	55,5

Material quality

Type	Material	Coating
HUS-V	Carbon steel	Galvanized ($\geq 5 \mu\text{m}$)

Anchor dimensions

Dimensions

Anchor size		HUS-V	8	10
Threaded outer diameter	d_t	[mm]	10,60	12,65
Core diameter	d_k	[mm]	7,1	8,70
Shaft diameter	d_s	[mm]	8,45	10,55
Stressed section	A_s	[mm ²]	36,6	59,4

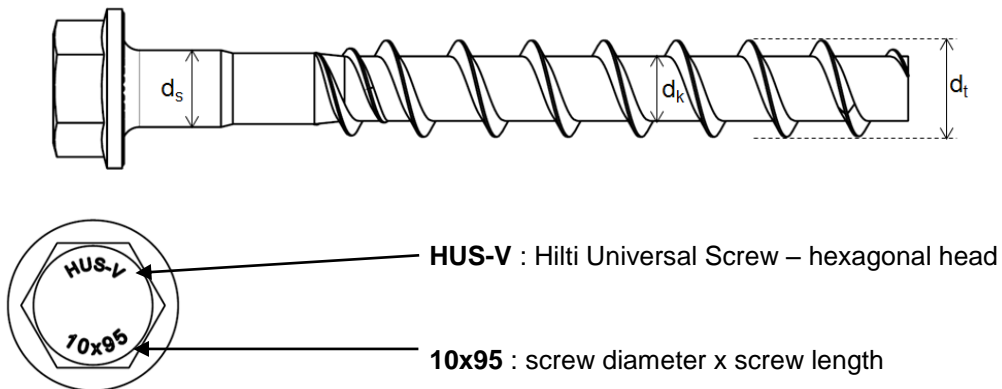

Screw length and thickness of fixture for HUS-V (hex head)

Anchor size	HUS-V	8		10	
		h_{nom1} 50	h_{nom2} 60	h_{nom1} 55	h_{nom2} 75
Nominal anchorage depth [mm]	Length of anchor [mm]	thickness of fixture			
		t_{fix1}	t_{fix2}	t_{fix1}	t_{fix2}
55		5	-	-	-
60		-	-	5	-
75		25	15	-	-
85		35	25	30	10
95		45	35	40	20
105		-	-	50	30

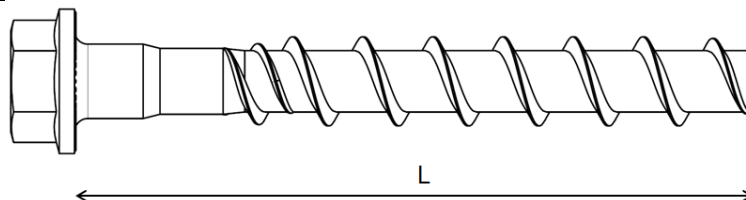

Setting

Installation equipment

Anchor size	HUS-V	8	10
Rotary hammer		TE 2 – TE 30	TE 2 – TE 30
Drill bit for concrete		CX 8	CX 10
Socket wrench insert		S-NSD 13 1/2	S-NSD 15 1/2
Tube for temporary application		HRG 8	HRG 10
Setting tool for concrete C12/15 to C50/60		SIW 22T-A – SIW 22-A	

Setting details for concrete

Anchor size	HUS-V	8	10
Nominal anchorage depth	h_{nom} [mm]	50	65
Nominal diameter of drill bit	d_o [mm]	8	10
Cutting diameter of drill bit	$d_{cut} \leq$ [mm]	8,45	10,45
Depth of drill hole	$h_1 \geq$ [mm]	60	75
Diameter of clearance hole in the fixture	$d_f \leq$ [mm]	12	14
Width across	SW [mm]	13	15
Impact screw driver		Hilti SIW 22 T-A or SIW 22-A	

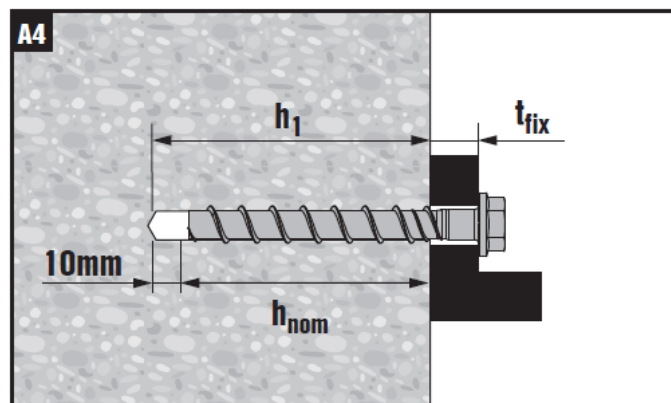

Setting instruction

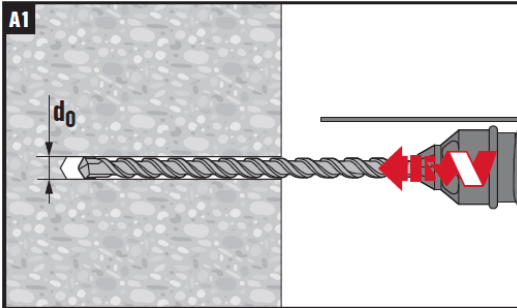

Make a cylindrical hole

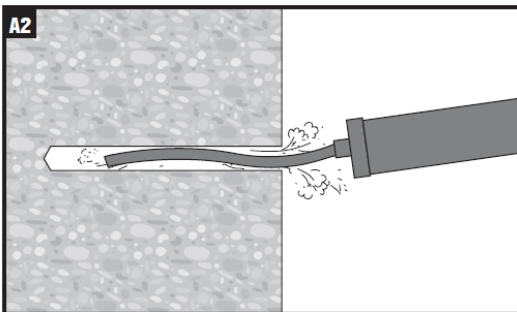

Clean the borehole

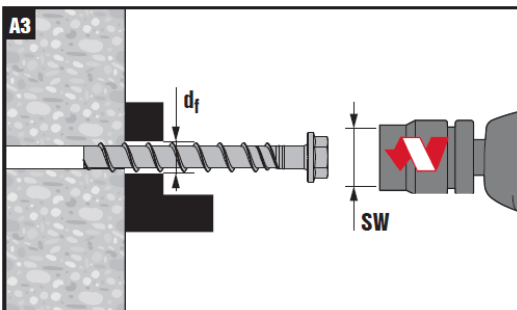

Install the screw anchor by impact screw driver Hilti SIW 22T-A or SIW22-A

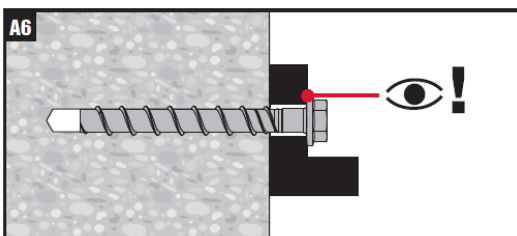
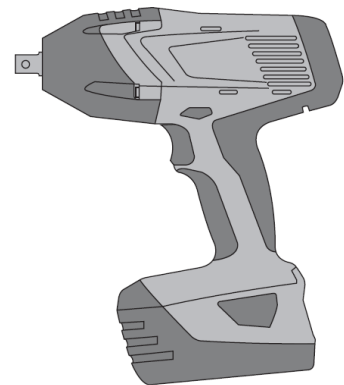

Ensure that the fixture is caught

For detailed information on installation see instruction for use given with the package of the product.

Design parameters

Anchor size	HUS-V	8		10	
Nominal anchorage depth	h_{nom} [mm]	50	65	55	75
Effective anchorage depth	h_{ef} [mm]	39,1	51,9	42,5	59,5
Minimum base material thickness	h_{min} [mm]	100	110	100	130
Minimum spacing	s_{min} [mm]	40	50	50	50
Minimum edge distance	c_{min} [mm]	50	50	50	50
Critical spacing for splitting failure	$s_{cr,sp}$ [mm]	117,3	140	130	180
Critical edge distance for splitting failure	$c_{cr,sp}$ [mm]	58,65	70	65	90
Critical spacing for concrete cone failure	$s_{cr,N}$ [mm]	117,3	177,3	127,5	178,5
Critical edge distance for concrete cone failure	$c_{cr,N}$ [mm]	58,65	88,65	63,75	89,25

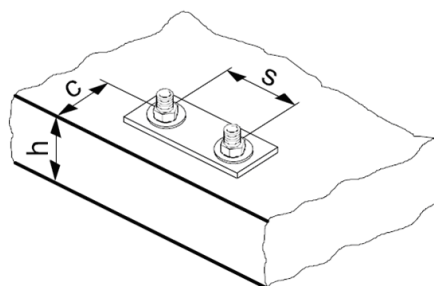

For spacing (edge distance) smaller than critical spacing (critical edge distance) the design loads have to be reduced,

Simplified design method

Simplified version of the design method according ETAG 001, Annex C,

- Influence of concrete strength
- Influence of edge distance
- Influence of spacing
- Valid for a group of two anchors, (The method may also be applied for anchor groups with more than two anchors or more than one edge, The influencing factors must then be considered for each edge distance and spacing, The calculated design loads are then conservative: They will be lower than the exact values according ETAG 001, Annex C.

The design method is based on the following simplification:

- No different loads are acting on individual anchors (no eccentricity)

The values are valid for one anchor,

Tension loading

The design tensile resistance is the lower value of

- Steel resistance: $N_{Rd,s}$
- Concrete pull-out resistance: $N_{Rd,p} = N_{Rd,p}^0 \cdot f_B$
- Concrete cone resistance: $N_{Rd,c} = N_{Rd,c}^0 \cdot f_B \cdot f_{1,N} \cdot f_{2,N} \cdot f_{3,N} \cdot f_{re,N}$
- Concrete splitting resistance (only non-cracked concrete):
 $N_{Rd,sp} = N_{Rd,c}^0 \cdot f_B \cdot f_{1,sp} \cdot f_{2,sp} \cdot f_{3,sp} \cdot f_{h,sp} \cdot f_{re,N}$

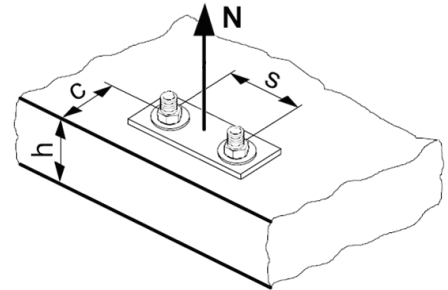

Basic design tensile resistance

Design steel resistance $N_{Rd,s}$

Anchor size	HUS-V	8		10	
$N_{Rd,s}$	[kN]	25		30,3	

Design pull-out resistance $N_{Rd,p} = N_{Rd,p}^0 \cdot f_B$

Anchor size	HUS-V	8		10	
Nominal anchorage depth	h_{nom} [mm]	50	65	55	75
Non-cracked concrete					
$N_{Rd,p}^0$	[kN]	5	8,9	5	9,5
Cracked concrete					
$N_{Rd,p}^0$	[kN]	2,2	5	3,3	7,6

Design concrete cone resistance $N_{Rd,c} = N_{Rd,c}^0 \cdot f_B \cdot f_{1,N} \cdot f_{2,N} \cdot f_{3,N} \cdot f_{re,N}$

Design splitting resistance ^{a)} $N_{Rd,sp} = N_{Rd,c}^0 \cdot f_B \cdot f_{1,sp} \cdot f_{2,sp} \cdot f_{3,sp} \cdot f_{h,sp} \cdot f_{re,N}$

Anchor size	HUS-V	8		10	
Nominal anchorage depth	h_{nom} [mm]	50	65	55	75
Non-cracked concrete					
$N_{Rd,c}^0$	[kN]	6,9	10,5	7,8	11,0
Cracked concrete					
$N_{Rd,c}^0$	[kN]	4,9	7,5	5,5	7,9

Influencing factors

Influence of concrete strength

Concrete strength designation (ENV 206)	C 20/25	C 25/30	C 30/37	C 35/45	C 40/50	C 45/55	C 50/60
Pull-out , concrete cone and splitting resistance							
$f_B = (f_{ck,cube}/25N/mm^2)^{1/2}$ a)	1	1,1	1,22	1,34	1,41	1,48	1,55

a) $f_{ck,cube}$ = concrete compressive strength, measured on cubes with 150 mm side length

Influence of edge distance a)

$c/c_{cr,N}$	0,1	0,2	0,3	0,4	0,5	0,6	0,7	0,8	0,9	1
$c/c_{cr,sp}$										
$f_{1,N} = 0,7 + 0,3 \cdot c/c_{cr,N} \leq 1$	0,73	0,76	0,79	0,82	0,85	0,88	0,91	0,94	0,97	1
$f_{1,sp} = 0,7 + 0,3 \cdot c/c_{cr,sp} \leq 1$										
$f_{2,N} = 0,5 \cdot (1 + c/c_{cr,N}) \leq 1$	0,55	0,60	0,65	0,70	0,75	0,80	0,85	0,90	0,95	1
$f_{2,sp} = 0,5 \cdot (1 + c/c_{cr,sp}) \leq 1$										

a) The edge distance shall not be smaller than the minimum edge distance c_{min} given in the table with the setting details, These influencing factors must be considered for every edge distance,

Influence of anchor spacing a)

$s/s_{cr,N}$	0,1	0,2	0,3	0,4	0,5	0,6	0,7	0,8	0,9	1
$s/s_{cr,sp}$										
$f_{3,N} = 0,5 \cdot (1 + s/s_{cr,N}) \leq 1$	0,55	0,60	0,65	0,70	0,75	0,80	0,85	0,90	0,95	1
$f_{3,sp} = 0,5 \cdot (1 + s/s_{cr,sp}) \leq 1$										

a) The anchor spacing shall not be smaller than the minimum anchor spacing s_{min} given in the table with the setting details, This influencing factor must be considered for every anchor spacing,

Influence of base material thickness

h/h_{min}	1,0	1,1	1,2	1,3	1,4	1,5	1,6	1,7	1,8	≥ 1,84
$f_{h,sp} = [h/(h_{min})]^{2/3}$	1	1,07	1,13	1,19	1,25	1,31	1,37	1,42	1,48	1,5

Influence of reinforcement a)

Anchor size	8		10	
Type	HUS-V			
Nominal anchorage depth h_{nom} [mm]	50	65	55	75
$f_{re,N} = 0,5 + h_{ef}/200mm \leq 1$	0,70	0,76	0,71	0,80

e) This factor applies only for dense reinforcement, If in the area of anchorage there is reinforcement with a spacing ≥ 150 mm (any diameter) or with a diameter ≤ 10 mm and a spacing ≥ 100 mm, then a factor $f_{re,N} = 1$ may be applied,

Shear loading

The design shear resistance is the lower value of

- Steel resistance: $V_{Rd,s}$
- Concrete pryout resistance: $V_{Rd,cp} = k \cdot N_{Rd,c}$
- Concrete edge resistance: $V_{Rd,c} = V_{Rd,c}^0 \cdot f_B \cdot f_{\beta} \cdot f_h \cdot f_4 \cdot f_{hef} \cdot f_c$

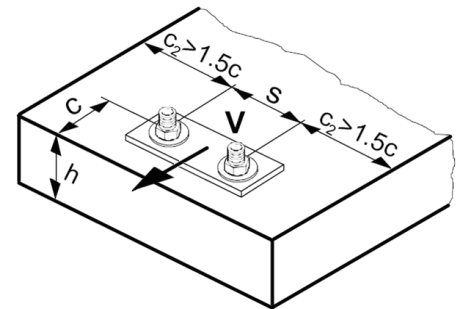

Basic design shear resistance

Design steel resistance $V_{Rd,s}$

Anchor size	HUS-V	8	10
$V_{Rd,s}$	[kN]	10,6	13

Design concrete pry-out resistance $V_{Rd,cp} = k \cdot N_{Rd,c}$ ^{a)}

Anchor size	HUS-V	8		10	
Nominal anchorage depth	h_{nom} [mm]	50	65	55	75
k		1	2	1	2

a) $N_{Rd,c}$: Design concrete cone resistance

Design concrete edge resistance ^{a)} $V_{Rd,c} = V_{Rd,c}^0 \cdot f_B \cdot f_{\beta} \cdot f_h \cdot f_4 \cdot f_{hef} \cdot f_c$

Anchor size	HUS-V	8		10	
Nominal anchorage depth	h_{nom} [mm]	50	65	55	75
Non-cracked concrete					
$V_{Rd,c}^0$	[kN]	5,0	5,0	7,2	6,2
Cracked concrete					
$V_{Rd,c}^0$	[kN]	3,5	3,5	5,1	4,4

d) For anchor groups only the anchors close to the edge must be considered,

Influencing factors

Influence of concrete strength

Concrete strength designation (ENV 206)	C 20/25	C 25/30	C 30/37	C 35/45	C 40/50	C 45/55	C 50/60
$f_B = (f_{ck,cube}/25N/mm^2)^{1/2}$ ^{a)}	1	1,1	1,22	1,34	1,41	1,48	1,55

a) $f_{ck,cube}$ = concrete compressive strength, measured on cubes with 150 mm side length

Influence of angle between load applied and the direction perpendicular to the free edge

Angle β	0°	10°	20°	30°	40°	50°	60°	70°	80°	≥ 90°
$f_{\beta} = \frac{1}{\sqrt{(\cos \alpha_v)^2 + \left(\frac{\sin \alpha_v}{2,5}\right)^2}}$	1	1,01	1,05	1,13	1,24	1,40	1,64	1,97	2,32	2,50

Influence of base material thickness

h/c	0,15	0,3	0,45	0,6	0,75	0,9	1,05	1,2	1,35	≥ 1,5
$f_h = \{h/(1,5 \cdot c)\}^{1/2} \leq 1$	0,32	0,45	0,55	0,63	0,71	0,77	0,84	0,89	0,95	1,00

Influence of anchor spacing and edge distance ^{a)} for concrete edge resistance: f_4

$$f_4 = (c/h_{ef})^{1,5} \cdot (1 + s / [3 \cdot c]) \cdot 0,5$$

c/h _{ef}	Single anchor	Group of two anchors s/h _{ef}														
		0,75	1,50	2,25	3,00	3,75	4,50	5,25	6,00	6,75	7,50	8,25	9,00	9,75	10,50	11,25
0,50	0,35	0,27	0,35	0,35	0,35	0,35	0,35	0,35	0,35	0,35	0,35	0,35	0,35	0,35	0,35	0,35
0,75	0,65	0,43	0,54	0,65	0,65	0,65	0,65	0,65	0,65	0,65	0,65	0,65	0,65	0,65	0,65	0,65
1,00	1,00	0,63	0,75	0,88	1,00	1,00	1,00	1,00	1,00	1,00	1,00	1,00	1,00	1,00	1,00	1,00
1,25	1,40	0,84	0,98	1,12	1,26	1,40	1,40	1,40	1,40	1,40	1,40	1,40	1,40	1,40	1,40	1,40
1,50	1,84	1,07	1,22	1,38	1,53	1,68	1,84	1,84	1,84	1,84	1,84	1,84	1,84	1,84	1,84	1,84
1,75	2,32	1,32	1,49	1,65	1,82	1,98	2,15	2,32	2,32	2,32	2,32	2,32	2,32	2,32	2,32	2,32
2,00	2,83	1,59	1,77	1,94	2,12	2,30	2,47	2,65	2,83	2,83	2,83	2,83	2,83	2,83	2,83	2,83
2,25	3,38	1,88	2,06	2,25	2,44	2,63	2,81	3,00	3,19	3,38	3,38	3,38	3,38	3,38	3,38	3,38
2,50	3,95	2,17	2,37	2,57	2,77	2,96	3,16	3,36	3,56	3,76	3,95	3,95	3,95	3,95	3,95	3,95
2,75	4,56	2,49	2,69	2,90	3,11	3,32	3,52	3,73	3,94	4,15	4,35	4,56	4,56	4,56	4,56	4,56
3,00	5,20	2,81	3,03	3,25	3,46	3,68	3,90	4,11	4,33	4,55	4,76	4,98	5,20	5,20	5,20	5,20
3,25	5,86	3,15	3,38	3,61	3,83	4,06	4,28	4,51	4,73	4,96	5,18	5,41	5,63	5,86	5,86	5,86
3,50	6,55	3,51	3,74	3,98	4,21	4,44	4,68	4,91	5,14	5,38	5,61	5,85	6,08	6,31	6,55	6,55
3,75	7,26	3,87	4,12	4,36	4,60	4,84	5,08	5,33	5,57	5,81	6,05	6,29	6,54	6,78	7,02	7,26
4,00	8,00	4,25	4,50	4,75	5,00	5,25	5,50	5,75	6,00	6,25	6,50	6,75	7,00	7,25	7,50	7,75
4,25	8,76	4,64	4,90	5,15	5,41	5,67	5,93	6,18	6,44	6,70	6,96	7,22	7,47	7,73	7,99	8,25
4,50	9,55	5,04	5,30	5,57	5,83	6,10	6,36	6,63	6,89	7,16	7,42	7,69	7,95	8,22	8,49	8,75
4,75	10,35	5,45	5,72	5,99	6,27	6,54	6,81	7,08	7,36	7,63	7,90	8,17	8,45	8,72	8,99	9,26
5,00	11,18	5,87	6,15	6,43	6,71	6,99	7,27	7,55	7,83	8,11	8,39	8,66	8,94	9,22	9,50	9,78
5,25	12,03	6,30	6,59	6,87	7,16	7,45	7,73	8,02	8,31	8,59	8,88	9,17	9,45	9,74	10,02	10,31
5,50	12,90	6,74	7,04	7,33	7,62	7,92	8,21	8,50	8,79	9,09	9,38	9,67	9,97	10,26	10,55	10,85

a) The anchor spacing and the edge distance shall not be smaller than the minimum anchor spacing s_{min} and the minimum edge distance c_{min} .

Influence of embedment depth

Anchor size	HUS-V	8		10	
Nominal anchorage depth	h_{nom} [mm]	50	65	55	75
$f_{hef} = 0,05 \cdot (h_{ef} / d)^{1,68}$		0,72	1,15	0,56	1,00

Influence of edge distance ^{a)}

c/d	4	6	8	10	15	20	30	40
$f_c = (d / c)^{0,19}$	0,77	0,71	0,67	0,65	0,60	0,57	0,52	0,50

a) The edge distance shall not be smaller than the minimum edge distance c_{min} .

Precalculated values

Design resistance calculated according ETAG 001, Annex C,
All data applies to concrete C 20/25 – $f_{ck,cube} = 25 \text{ N/mm}^2$,

Design resistance

Single anchor, no edge effects

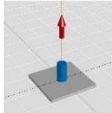
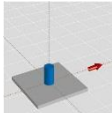
Anchor size		HUS-V	8		10	
Nominal anchorage depth	h_{nom} [mm]		50	65	55	75
Min, base material thickness	h_{min} [mm]		100	110	100	130
	Tensile N_{Rd}					
	Non-cracked concrete					
		[kN]	5,0	8,9	5,0	9,5
	Cracked concrete					
	[kN]	2,2	5,0	3,3	7,6	
	Shear V_{Rd}, without lever arm					
	Non-cracked concrete					
		[kN]	6,9	10,6	7,8	13,0
	Cracked concrete					
	[kN]	4,9	10,6	5,5	13,0	

Single anchor, min, edge distance ($c = c_{min}$)

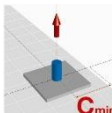
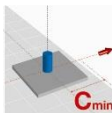
Anchor size		HUS-V	8		10	
Nominal anchorage depth	h_{nom} [mm]		50	65	55	75
Min, base material thickness	h_{min} [mm]		100	110	100	130
Min, edge distance	c_{min} [mm]		50	50	50	50
	Tensile N_{Rd}					
	Non-cracked concrete					
		[kN]	5,0	7,7	5,0	7,4
	Cracked concrete					
	[kN]	2,2	5,0	3,3	5,3	
	Shear V_{Rd}, without lever arm					
	Non-cracked concrete					
		[kN]	3,7	3,9	3,8	3,5
	Cracked concrete					
	[kN]	2,6	2,8	2,7	2,5	

Double anchor, no edge effects, min, spacing ($s = s_{min}$),
 (load values are valid for one anchor)

Anchor size		HUS-V	8		10	
Nominal anchorage depth	h_{nom} [mm]		50	65	55	75
Min, base material thickness h_{min} [mm]			100	110	100	130
Min, spacing s_{min} [mm]			40	50	50	50
	Tensile N_{Rd}					
	Non-cracked concrete					
		[kN]	4,6	6,9	5,4	7,1
	Cracked concrete					
	[kN]	3,3	4,9	3,8	5,0	
	Shear V_{Rd}, without lever arm					
	Non-cracked concrete					
		[kN]	4,6	10,6	5,4	13,0
	Cracked concrete					
	[kN]	3,3	9,9	3,9	10,1	

Basic loading data for temporary application in standard and fresh concrete < 28 days old, $f_{ck,cube} \geq 10 \text{ N/mm}^2$:

All data in this section applies to the following conditions:

- Strength class, $f_{ck,cube} \geq 10 \text{ N/mm}^2$
- Only temporary use
- Screw is reusable, before each usage it must be checked according Hilti instruction for use with the suited tube Hilti HRG
- Design resistance and recommended load are valid for single anchor only
- Design resistance as well as the recommended load are valid for all load direction and valid for both cracked and non-cracked concrete
- Minimum base material thickness
- No edge distance and spacing influence

Design resistance

Anchor size	HUS-V	8		10	
Nominal embedment depth	h_{nom} [mm]	50	65	55	75
Cracked and non-cracked concrete					
Tensile N_{Rd} = Shear V_{Rd}					
$f_{ck,cube} \geq 10 \text{ N/mm}^2$	[kN]	1,4	3,0	1,7	3,2
$f_{ck,cube} \geq 15 \text{ N/mm}^2$	[kN]	1,7	3,7	2,1	3,9
$f_{ck,cube} \geq 20 \text{ N/mm}^2$	[kN]	2,0	4,2	2,4	4,5

Recommended load

Anchor size	HUS-V	8		10	
Nominal embedment depth	h_{nom} [mm]	50	65	55	75
Tensile N_{rec} = Shear V_{rec}					
$f_{ck,cube} \geq 10 \text{ N/mm}^2$	[kN]	1,0	2,1	1,2	2,3
$f_{ck,cube} \geq 15 \text{ N/mm}^2$	[kN]	1,2	2,6	1,5	2,8
$f_{ck,cube} \geq 20 \text{ N/mm}^2$	[kN]	1,4	3,0	1,7	3,2

a) With overall partial safety factor for action $\gamma = 1,4$. The partial safety factors for action depend on the type of loading and shall be taken from national regulations.

Setting details

Anchor size		HUS-V	8		10	
Nominal anchorage depth	h_{nom}	[mm]	50	65	55	75
Minimum base material thickness	h_{min}	[mm]	100	110	100	130
Minimum spacing	s_{min}	[mm]	135	225	150	240
Minimum edge distance direction 1	c_1	[mm]	45	75	50	80
Minimum edge distance direction 2	c_2	[mm]	70	115	75	120

Setting details

Anchor size		HUS-V	8		10	
Nominal anchorage depth	h_{nom}	[mm]	50	65	55	75
Nominal diameter of drill bit	d_o	[mm]	8		10	
Cutting diameter of drill bit	$d_{cut} \leq$	[mm]	8,45		10,45	
Depth of drill bit	$h_1 \leq$	[mm]	60	75	65	85
Diameter of clearance hole in the fixture	$d_f \leq$	[mm]	12		14	
Width across	SW	[mm]	13		15	
Impact screw driver	Hilti SIW 22 T-A or SIW 22 A					
Suited tube			Hilti HRG 8		Hilti HRG 10	

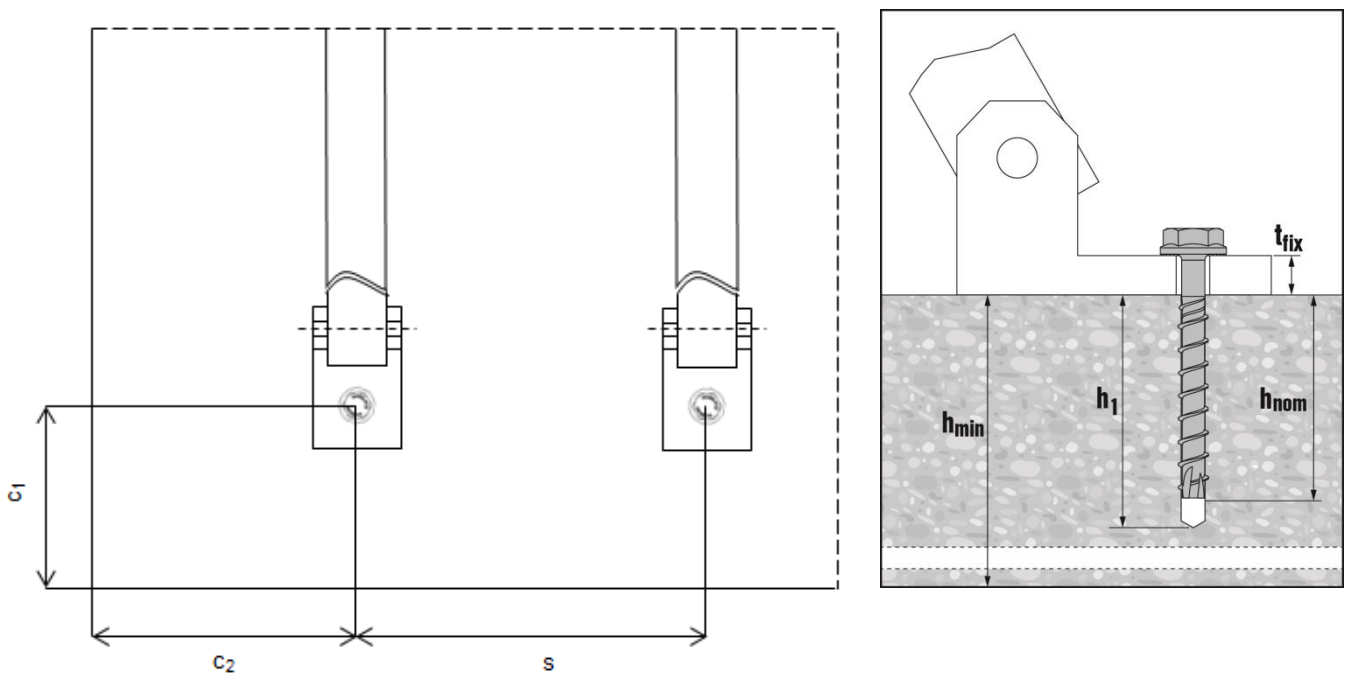

Tube specification

Anchor size / tube		8 / HRG 8	10 / HRG 10
Inner tube diameter	\varnothing_i [mm]	9,7	11,7
Outer tube diameter	\varnothing_e [mm]	15,0	17,0
Tube length	Lt [mm]	23,0	28,0

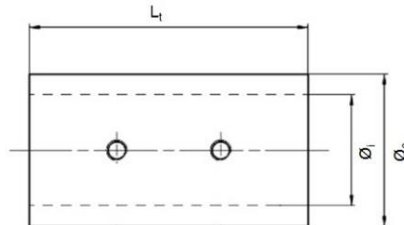

Instruction for use – re-use of screw

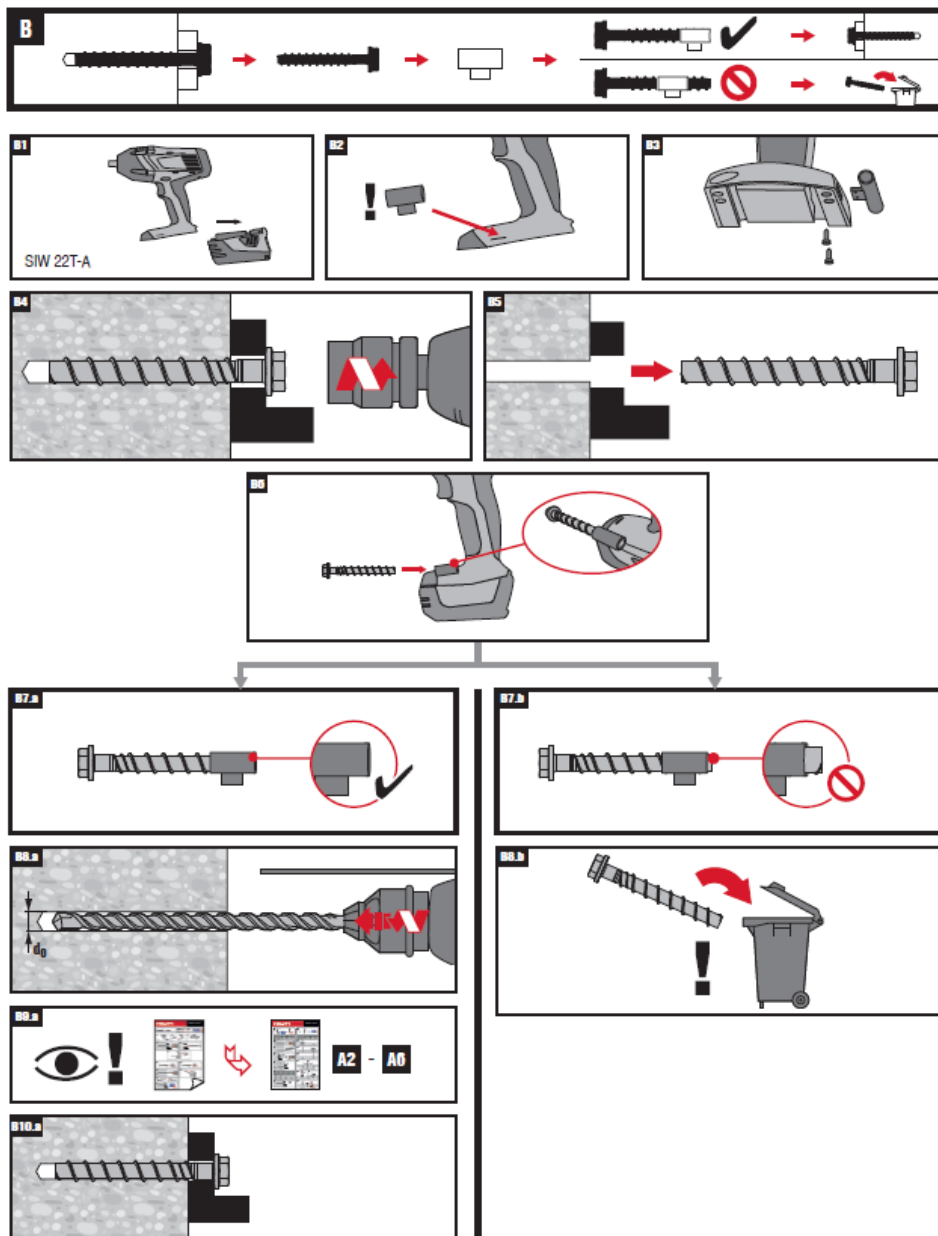

HUS Screw anchor, carbon steel

	Anchor version	Benefits
	HUS-A 6 Carbon steel Concrete Screw with hex head	<ul style="list-style-type: none"> - Quick and easy setting - Low expansion forces in base materials - Through fastening - Removable - Forged-on washer and hexagon head with no protruding thread
	HUS-H 6 Carbon steel Concrete Screw with hex head	
	HUS-H 8 HUS-H 10 HUS-H 14 Carbon steel Concrete Screw with hex head	
	HUS-I 6 Carbon steel Concrete Screw with hex head	
	HUS-P 6 Carbon steel Concrete Screw with pan head	



Concrete



Tensile zone

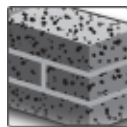

Solid brick

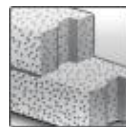

Autoclaved aerated concrete

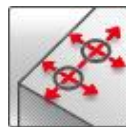

Small edge distance and spacing



Fire resistance



European Technical Approval



CE conformity



PROFIS Anchor design software

Approvals / certificates

Description	Authority / Laboratory	No. / date of issue
European technical approval ^{a)} with fire assessment according TR020	DIBt, Berlin	ETA-08/0307/ 2014-04-29
Fire test report	IBMB, Brunswick	UB3574/5146/ 2006-05-20
Fire Assessment report	Exova Warringtonfire	WF 166402/ 2007-10-26

a) Does not include HUS-H 14

Basic loading data for concrete C20/25

All data in this section applies to

- Correct setting (see setting instruction)
- No edge distance and spacing influence
- Steel failure
- Minimum base material thickness
- Concrete C 20/25, $f_{ck,cube} = 25 \text{ N/mm}^2$

The following technical data are based on:

ETA: Data according ETA-08/0307 issue 2014-04-29

Hilti: Additional Hilti technical data

For details see simplified design method

Mean ultimate resistance

		ETA-08/0307						Hilti				
Anchor size		6		8		10		8	10	14		
Type	HUS-	A, H, I	P	H		H		H	H	H		
h_{nom}	[mm]	55	55	60	75	70	85	50	60	70	90	110
Non-cracked concrete												
Tensile $N_{Ru,m}$	[kN]	12,0	10,0	16,0	21,3	16,0	26,7	11,2	16,0	23,8	36,9	56,0
Shear $V_{Ru,m}$	[kN]	13,2	13,2	16,7	16,7	25,1	25,1	16,7	25,1	47,6	53,8	53,8
Cracked concrete												
Tensile $N_{Ru,m}$	[kN]	8,0		8,0	12,0	10,0	21,3	5,2	8,5	-	19,1	-
Shear $V_{Ru,m}$	[kN]	13,2		16,7	16,7	25,1	25,1	16,7	25,1	-	53,8	-

Characteristic resistance

		ETA-08/0307						Hilti				
Anchor size		6		8		10		8	10	14		
Type	HUS-	A, H, I	P	H		H		H	H	H		
h_{nom}	[mm]	55	55	60	75	70	85	50	60	70	90	110
Non-cracked concrete												
Tensile N_{Rk}	[kN]	9,0	7,5	12,0	16,0	12,0	20,0	8,4	12,0	17,8	27,6	42
Shear V_{Rk}	[kN]	12,5	12,5	15,9	15,9	23,8	23,8	15,9	23,8	35,6	51,2	51,2
Cracked concrete												
Tensile N_{Rk}	[kN]	6,0		6,0	9,0	7,5	16,0	3,9	6,4	-	14,3	-
Shear V_{Rk}	[kN]	12,5		15,9	15,9	23,8	23,8	15,6	21,0	-	39,5	-

Design resistance

		ETA-08/0307						Hilti				
Anchor size		6		8		10		8	10	14		
Type	HUS-	A, H, I	P	H		H		H	H	H		
h_{nom}	[mm]	55	55	60	75	70	85	50	60	70	90	110
Non-cracked concrete												
Tensile N_{Rd}	[kN]	5,0	4,2	6,7	8,9	6,7	9,5	4,7	6,7	9,9	15,4	24,0
Shear V_{Rd}	[kN]	8,3	8,3	10,6	10,6	15,9	15,9	10,6	15,9	23,8	34,1	34,1
Cracked concrete												
Tensile N_{Rd}	[kN]	3,3		3,3	5,0	4,2	7,6	2,2	3,6	-	9,5	-
Shear V_{Rd}	[kN]	8,3		10,6	10,6	15,9	15,9	10,4	14,0	-	26,3	-

Recommended loads

		ETA-08/0307						Hilti				
Anchor size		6		8		10		8	10	14		
Type	HUS-	A, H, I	P	H		H		H	H	H		
h_{nom}	[mm]	55	55	60	75	70	85	50	60	70	90	110
Non-cracked concrete												
Tensile N_{rec}	[kN]	3,6	3,0	4,8	6,3	4,8	6,8	3,3	4,8	7,1	11,0	17,1
Shear V_{rec}	[kN]	6,0	6,0	7,6	7,6	11,3	11,3	7,6	11,3	17,0	24,4	24,4
Cracked concrete												
Tensile N_{rec}	[kN]	2,4		2,4	3,6	3,0	5,4	1,5	2,5	-	6,8	-
Shear V_{rec}	[kN]	6,0		7,6	7,6	11,3	11,3	7,4	10,0	-	18,8	-

a) With overall partial safety factor for action $\gamma = 1,4$. The partial safety factors for action depend on the type of loading and shall be taken from national regulations.

Basic loading data for concrete < 28 days old and $f_{ck,cube} \geq 15 \text{ N/mm}^2$:

All data in this section applies to the following conditions:

Concrete:

- Strength class C 20/25, $f_{ck,cube} \geq 15 \text{ N/mm}^2$

Installation:

- For hand installation $T_{inst,rec} = 40 \text{ Nm}$

The anchor is correct mounted, if there is neither a turn-through or spinning of the screw in the drill hole nor that an easy turning of the screw is possible after the installation procedure when the head of the screw has touched the fixture.

Loads:

- No edge distance and spacing influence
- Minimum base material thickness

Recommended loads in non-cracked concrete

		Hilti		
Anchor size		14	14	14
Type	HUS-	H	H	H
h_{nom}	[mm]	70	90	110
Non-cracked concrete				
Tensile $N_{rec}^{a)}$	[kN]	3,5	5,5	7,5
Shear $V_{rec}^{a)}$	[kN]	6,6	14,0	16,5

a) Values serve as a reference, onsite testing is recommended to determine actual loading potential of the anchors

Basic loading data for single anchor in solid masonry units:

All data in this section applies to the following conditions:

Solid bricks: a reduction of the cross section area by a vertical perforation perpendicular to the bed joint area must not be greater than 15%

Drilling:

- Holes in Mz and KS drilled with TE rotary hammers drilled with hammering mode
- Holes in PPW drilled with TE rotary hammers drilled without hammering mode

Installation:



- The anchor is correct mounted, if there is neither a turn-through or spinning of the screw in the drill hole nor that an easy turning of the screw is possible after the installation procedure when the head of the screw has touched the fixture

Edge distance and spacing influences:

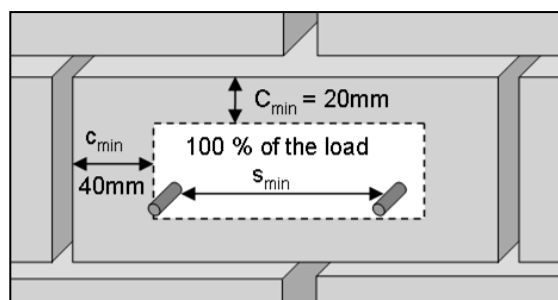
- Distance to free edge free edge to solid masonry (Mz and KS) units $c_{min,free} \geq 200 \text{ mm}$
- Distance to free edge free edge to solid masonry (autoclaved aerated gas concrete) units $c_{min,free} \geq 170 \text{ mm}$
- The minimum distance to horizontal and vertical mortar joint $c_{min,h}$ and $c_{min,v}$ is stated in drawing below
- Minimum anchor spacing in one brick/block is $s_{min} = 80 \text{ mm}$

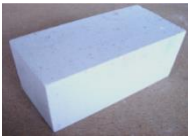

Recommended loads

		Hilti			
		6	8	10	
Base material	Anchor size		A, H, I, P	H	H
	Type	HUS-			
	h_{nom}	[mm]	55	60	70
	Compressive strength class	[N/mm ²]	$F_{rec}^{a)}$ [kN] Tensile and Shear		
 <p>Solid clay brick Mz 2,0-2DF DIN V 105-100 / EN 771-1 LxWxH [mm]: 240x115x113 h_{min} [mm]: 115</p>	≥ 8		0,6	0,8	1,0
	≥ 10		0,7	0,9	1,2
	≥ 12		0,8	1,0	1,3
	≥ 16		0,9	1,2	1,5
	≥ 20		0,9	1,3	1,7
 <p>Solid sand-lime brick KS 2,0-2DF DIN V 106-100 / EN 771-2 LxWxH [mm]: 240x115x113 h_{min} [mm]: 115</p>	≥ 8		0,8	1,0	1,1
	≥ 10		0,9	1,1	1,2
	≥ 12		1,0	1,2	1,3
	≥ 16		1,1	1,3	1,5
	≥ 20		1,2	1,5	1,7
 <p>Aerated concrete PPW -0,65 DIN 4165/ EN 771-4 LxWxH [mm]: 499x240x249 h_{min} [mm]: 240</p>	≥ 6		0,4	0,5	1,3

a) Characteristic resistance for tension, shear or combined tension and shear loading.

The characteristic resistance is valid for single anchor or for a group of two or four anchors with a spacing equal or larger than the minimum spacing s_{min} according to specification.

Load values:

- The technical data for the HUS-H anchors are reference loads for MZ 12 2,0-2DF, KS 12 2,0-2DF and PPW 6-0,65.
- The load Values are valid for non-structural applications.
- Due to the natural variation of stone solid bricks, on site anchor testing is recommended to validate technical data.
- The HUS-H anchor was installed and tested in the centre area of solid bricks as shown considering minimal edge and space distances.
- The HUS-H anchor was not tested in the mortar joint between solid bricks or in hollow bricks; however a load reduction is expected.
- For brick walls where anchor position in brick can not be determined, 100% anchor testing is recommended.

Limitations of loads:

- All data is for redundant fastening for non structural applications
- Plaster, graveling, lining or leveling courses are regarded as non-bearing and may not be taken into account for the calculation of embedment depth.
- The decisive resistance to tension loads is the lower value of N_{rec} (brick breakout, pull out) and $N_{max,pb}$ (pull out of one brick).

Pull out of one brick:

The allowable load of an anchor or a group of anchors in case of single brick pull out, $N_{max,pb}$ [kN], is given in the following tables:

Clay bricks:

	$N_{max,pb}$ [kN]	brick breadth b_{brick} [mm]					
		80	120	200	240	300	360
brick length l_{brick} [mm]	240	1,1	1,6	2,7	3,3	4,1	4,9
	300	1,4	2,1	3,4	4,1	5,1	6,2
	500	2,3	3,4	5,7	6,9	8,6	10,3

All other brick types:

	$N_{max,pb}$ [kN]	brick breadth b_{brick} [mm]					
		80	120	200	240	300	360
brick length l_{brick} [mm]	240	0,8	1,2	2,1	2,5	3,1	3,7
	300	1,0	1,5	2,6	3,1	3,9	4,6
	500	1,7	2,6	4,3	5,1	6,4	7,7

$N_{max,pb}$ = resistance for pull out of one brick
 l_{brick} = length of the brick
 b_{brick} = breadth of the brick

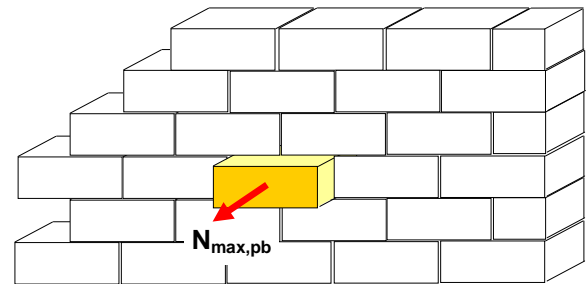
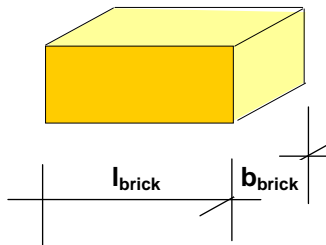

Materials

Mechanical properties

Anchor size		6	8	10	14
Type	HUS-	A, H, I, P	H	H	H
Nominal tensile strength f_{uk}	[N/mm ²]	930	950	1000	770
Yield strength f_{yk}	[N/mm ²]	750	855	900	700
Stressed cross-section A_s	[mm ²]	26,9	39,0	55,4	143,1
Moment of resistance W	[mm ³]	19,6	34,4	58,2	191,7
Design bending resistance $M_{Rd,s}$	[Nm]	21,9	26,1	46,5	118

Material quality

Part	Designation	Material
Screw anchor	HUS-A 6	Carbon Steel, galvanized ($\geq 5 \mu\text{m}$)
	HUS-H 6	
	HUS-I 6	
	HUS-P 6	
	HUS-H 8	
	HUS-H 10	
	HUS-H 14	

Head configuration

HUS-A 6
External thread
M8 or M10

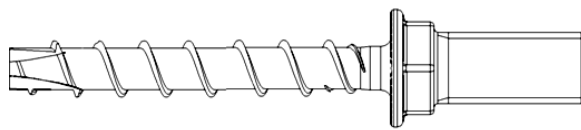

Circle mark with $d = 2,5 \text{ mm}$ for $h_{\text{nom}} = 55 \text{ mm}$

HUS-H 6
Hex head

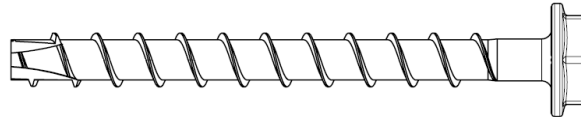

HUS-I 6
Internal threads
M8 and M10

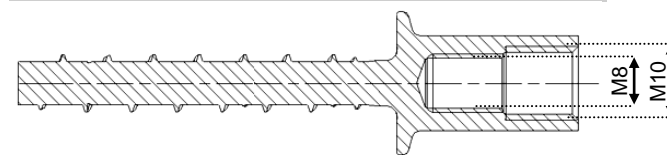

Two circle marks with $d = 0,8 \text{ mm}$ for $h_{\text{nom}} = 55 \text{ mm}$

HUS-P 6
Pan head

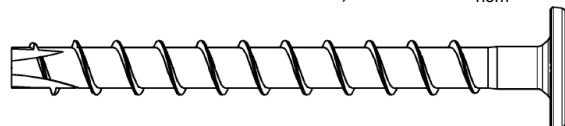

HUS-H 8
HUS-H 10
HUS-H 14

Hex head

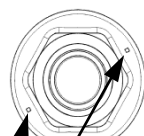
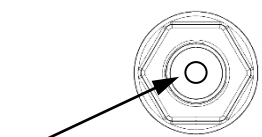
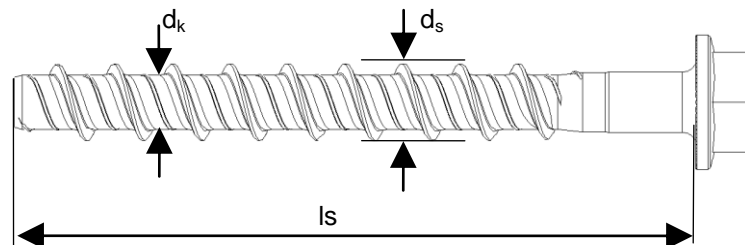

Anchor dimensions:

Dimensions

Anchor size			6				8	10	14
Type	HUS-		A	H	I	P	H	H	H
Nominal length	l_s	[mm]	55	60..120	55	60..80	65..150	75..280	80..160
Outer diameter of thread	d_s	[mm]	7,85				10,1	12,3	16,55
Core diameter	d_k	[mm]	5,85				7,1	8,4	12,6

Setting:

Recommended installation equipment

Anchor Size		6				8			10			14		
Type	HUS-	A	I	H	P	H			H			H		
h_{nom}	[mm]	55				50	60	70	60	70	85	70	90	110
Rotary hammer		TE 2 - TE 7				TE 2 - TE 30								
drill bit for concrete, solid clay brick solid sand-lime brick		TE -CX 6				TE -CX 8			TE -CX 10			TE -CX 14		
drill bit for aerated concrete		TE -CX 5				TE -CX 6			TE -CX 8			-		
Socket wrench insert		S-NSD 13 1/2 L		-		S-NSD 13 1/2 L			S-NSD 15 1/2			S-NSD 21 1/2		
TORX		-		TXI 30		-			-			-		
Setting tool		SIW/ SID 121 SIW/ SID 144 TKI 2500				SIW 22T-A SI 100								

Setting details for concrete from C20/25 to C50/60

Anchor size			6				8			10			14		
Type	HUS-		A	I	H	P	H			H			H		
h_{nom}	[mm]		55				50	60	70	60	70	85	70	90	110
Nominal diameter of drill bit	d_0	[mm]	6				8			10			14		
Cutting diameter of drill bit	$d_{cut} \leq$	[mm]	6,4				8,45			10,45			14,50		
Clearance hole diameter	d_f	[mm]	9				12			14			18		
Depth of drill hole in floor/ wall position	$h_1 \geq$	[mm]	$h_{nom}+10$ mm				$h_{nom}+10$ mm			$h_{nom}+10$ mm			$h_{nom}+10$ mm		
Depth of drill hole in ceiling position	$h_1 \geq$	[mm]	$h_{nom}+3$ mm												
Thickness of fixture	t_{fix}	[mm]	$l_s - h_{nom}$												
Max. installation torque for hand setting	max. T_{inst}	[Nm]	25				35	35	45	45	45	55	65 (40) ^{a)}		
Impact screw driver for machine setting			SIW/SID 121,144 TKI 2500				SIW 22T-A SI 100						SIW 22T-A SI 100 ^{b)}		

^{a)} For concrete < 28 days old and $f_{ck,cube} \geq 15$ N/mm²

^{b)} For concrete < 28 days old and $f_{ck,cube} \geq 15$ N/mm² only hand setting is recommended

Setting details for masonry

Anchor size		6				8	10
Type	HUS-	A	I	H	P	H	H
h_{nom}	[mm]	55				60	70
Nominal diameter of drill bit diameter for solid clay (Mz) and sand-lime brick (KS)	d_0 [mm]	6				8	10
Nominal diameter of drill bit Aerated concrete (PPW)	d_0 [mm]	5				6	8
Clearance hole diameter	d_f [mm]	9				12	14
Depth of drill hole	$h_1 \geq$ [mm]	$h_{nom} + 10 \text{ mm}$					
Thickness of fixture	t_{fix} [mm]	$l_s - h_{nom}$					
Max. installation torque for hand setting ^{a)}							
Solid clay brick (MZ)	max. T_{inst} [Nm]	8				8	8
Solid sand-lime brick (KS)	max. T_{inst} [Nm]	12				16	16
Aerated concrete (PPW)	max. T_{inst} [Nm]	5				5	8

^{a)} Only hand setting is recommended

Setting instruction

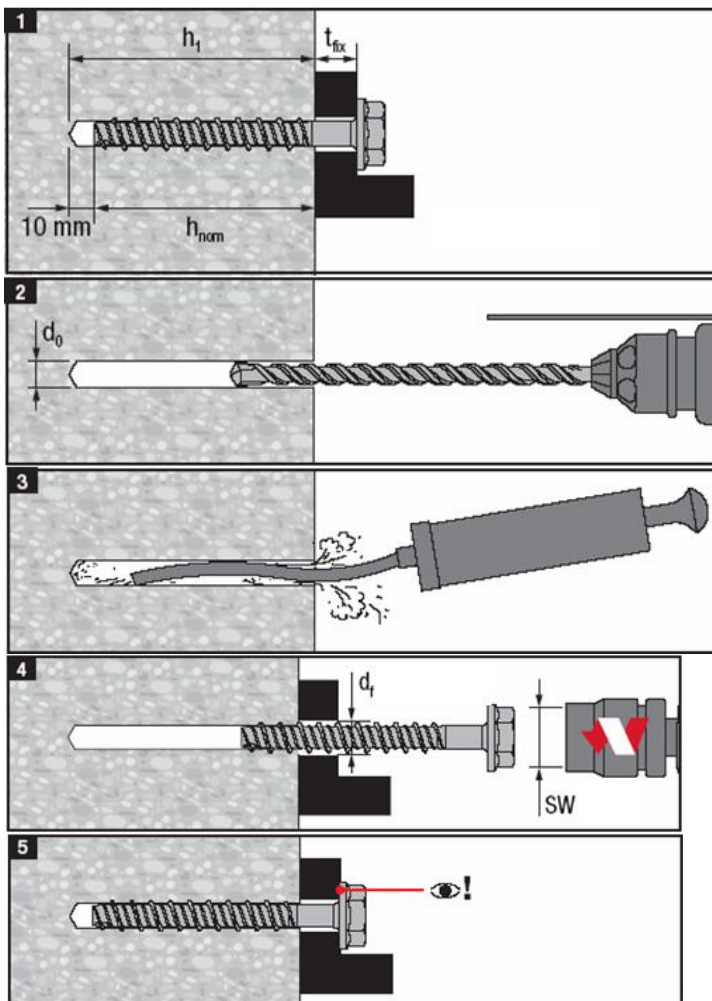

For detailed information on installation see instruction for use given with the package of the product.

Base material thickness, anchor spacing and edge distance for concrete from C20/25 to C50/60

Anchor size			6		8			10			14	
Type	HUS-		A, I, H, P		H			H			H	
h_{nom}	[mm]		55	50	60	75	60	70	85	70	90	110
Minimum base material thickness	h_{min}	[mm]	100	100	110	120	110	130	130	130	170	210
non-cracked concrete	Minimum spacing	s_{min}	35	55			65			80		
	Minimum edge distance	c_{min}	35	55			65			60		
cracked concrete	Minimum spacing	s_{min}	35	55	40	40	65	50	50	-	80	-
	Minimum edge distance	c_{min}	35	55	50	50	65	50	50	-	60	-
Effective anchorage depth	h_{ef}	[mm]	42	36	47	60	44	54	67	50	69	90
Critical spacing for concrete cone failure	$s_{cr,N}$	[mm]	3 h_{ef}									
Critical spacing for splitting failure	$s_{cr,sp}$	[mm]										
Critical edge distance for concrete cone failure	$c_{cr,N}$	[mm]	1,5 h_{ef}									
Critical edge distance for splitting failure	$c_{cr,sp}$	[mm]										

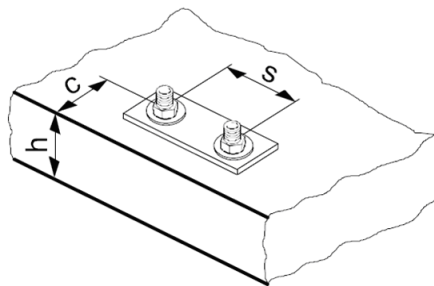

For spacing and/ or edge distance smaller than critical spacing and/ or critical edge distance the design loads have to be reduced.

Critical spacing and critical edge distance for splitting failure apply only for non-cracked concrete. For cracked concrete only the critical spacing and critical edge distance for concrete cone failure are decisive.

Simplified design method

Simplified version of the design method according ETAG 001, Annex C. Design resistance according data given in ETA-08/0307 issue 2014-04-29.

- Influence of concrete strength
- Influence of edge distance
- Influence of spacing

- Valid for a group of two anchors. (The method may also be applied for anchor groups with more than two anchors or more than one edge. The influencing factors must then be considered for each edge distance and spacing. The calculated design loads are then on the save side: They will be lower than the exact values according ETAG 001, Annex C. To avoid this, it is recommended to use the anchor design software PROFIS anchor)

The design method is based on the following simplification:

- No different loads are acting on individual anchors (no eccentricity)

The values are valid for one anchor.

For more complex fastening applications please use the anchor design software PROFIS Anchor.

Tension loading

The design tensile resistance is the lower value of

- Steel resistance: $N_{Rd,s}$
- Concrete pull-out resistance: $N_{Rd,p} = N_{Rd,p}^0 \cdot f_B$
- Concrete cone resistance: $N_{Rd,c} = N_{Rd,c}^0 \cdot f_B \cdot f_{1,N} \cdot f_{2,N} \cdot f_{3,N} \cdot f_{re,N}$
- Concrete splitting resistance (only non-cracked concrete):
 For HUS-A, H, I, P $N_{Rd,sp} = N_{Rd,p}^0 \cdot f_B \cdot f_{1,sp} \cdot f_{2,sp} \cdot f_{3,sp} \cdot f_{h,sp} \cdot f_{re,N}$
 For all the other HUS $N_{Rd,sp} = N_{Rd,c}^0 \cdot f_B \cdot f_{1,sp} \cdot f_{2,sp} \cdot f_{3,sp} \cdot f_{h,sp} \cdot f_{re,N}$

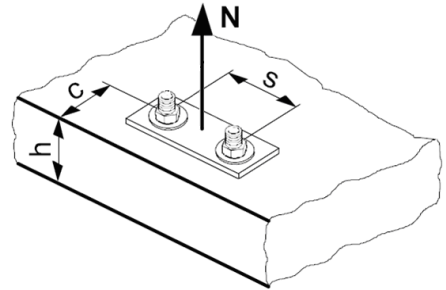

Basic design tensile resistance

Design steel resistance $N_{Rd,s}$

	ETA-08/0307			Hilti
Anchor size	HUS-A, H, I, P	HUS-H 8	HUS-H 10	HUS-H 14
$N_{Rd,s}$ [kN]	16,7	26,5	39,6	67,5

ETA: Data according ETA-08/0307 issue 2014-04-29 Hilti: Additional Hilti technical data

Design pull-out resistance $N_{Rd,p} = N_{Rd,p}^0 \cdot f_B$

	ETA-08/0307						Hilti					
Anchor size	6		8		10		8	10	14			
Type	HUS-A, H, I, P		H		H		H		H			
h_{nom}	55	55	60	75	70	85	50	60	70	90	110	
Non-cracked concrete												
Tensile $N_{Rd,p}^0$ [kN]	5	4,2	6,7	8,9	6,7	9,5	4,7	6,7	14,7	22,7	28,0	
Cracked concrete												
Tensile $N_{Rd,p}^0$ [kN]	3,3	3,3	3,3	5,0	4,2	7,6	2,2	3,6	-	9,5	-	

ETA: Data according ETA-08/0307 issue 2014-04-29 Hilti: Additional Hilti technical data

Design concrete cone resistance $N_{Rd,c} = N_{Rd,c}^0 \cdot f_B \cdot f_{1,N} \cdot f_{2,N} \cdot f_{3,N} \cdot f_{re,N}$

Design splitting resistance a) $N_{Rd,sp} = N_{Rd,c}^0 \cdot f_B \cdot f_{1,sp} \cdot f_{2,sp} \cdot f_{3,sp} \cdot f_{h,sp} \cdot f_{re,N}$

b) $N_{Rd,sp} = N_{Rd,p}^0 \cdot f_B \cdot f_{1,sp} \cdot f_{2,sp} \cdot f_{3,sp} \cdot f_{h,sp} \cdot f_{re,N}$

	ETA-08/0307					Hilti				
Anchor size	6	8	8	10	10	8	10	14	14	14
h_{nom}	55	60	75	70	85	50	60	70	90	110
Non-cracked concrete										
Tensile $N_{Rd,c}^0$ [kN]	7,6	9,0	13,0	11,1	13,2	6,0	8,2	11,9	18,4	28,7
Cracked concrete										
Tensile $N_{Rd,c}^0$ [kN]	5,4	6,4	9,3	7,9	9,4	4,3	5,8	-	13,2	-

a) Splitting resistance must only be considered for non-cracked concrete

b) Equation valid for HUS-A, H, I, P 6

ETA: Data according ETA-08/0307 issue 2014-04-29 Hilti: Additional Hilti technical data

Influencing factors

Influence of concrete strength

Concrete strength designation (ENV 206)	HUS	h_{nom}	C 20/25	C 25/30	C 30/37	C 35/45	C 40/50	C 45/55	C 50/60
$f_B = (f_{ck,cube}/25N/mm^2)^{0,5}$ ^{a)}	6	55	1	1,10	1,22	1,34	1,41	1,48	1,55
	8	50...75							
	10	85							
	14	70...110							
$f_B = (f_{ck,cube}/25N/mm^2)^{0,4}$ ^{a)}	10	60...70	1	1,08	1,17	1,27	1,32	1,37	1,42

a) $f_{ck,cube}$ = concrete compressive strength, measured on cubes with 150 mm side length

Influence of edge distance ^{a)}

$c/c_{cr,N}$	0,1	0,2	0,3	0,4	0,5	0,6	0,7	0,8	0,9	1
$c/c_{cr,sp}$										
$f_{1,N} = 0,7 + 0,3 \cdot c/c_{cr,N} \leq 1$	0,73	0,76	0,79	0,82	0,85	0,88	0,91	0,94	0,97	1
$f_{1,sp} = 0,7 + 0,3 \cdot c/c_{cr,sp} \leq 1$										
$f_{2,N} = 0,5 \cdot (1 + c/c_{cr,N}) \leq 1$	0,55	0,60	0,65	0,70	0,75	0,80	0,85	0,90	0,95	1
$f_{2,sp} = 0,5 \cdot (1 + c/c_{cr,sp}) \leq 1$										

a) The edge distance shall not be smaller than the minimum edge distance c_{min} given in the table with the setting details. These influencing factors must be considered for every edge distance.

Influence of anchor spacing ^{a)}

$s/s_{cr,N}$	0,1	0,2	0,3	0,4	0,5	0,6	0,7	0,8	0,9	1
$s/s_{cr,sp}$										
$f_{3,N} = 0,5 \cdot (1 + s/s_{cr,N}) \leq 1$	0,55	0,60	0,65	0,70	0,75	0,80	0,85	0,90	0,95	1
$f_{3,sp} = 0,5 \cdot (1 + s/s_{cr,sp}) \leq 1$										

a) The anchor spacing shall not be smaller than the minimum anchor spacing s_{min} given in the table with the setting details. This influencing factor must be considered for every anchor spacing.

Influence of base material thickness

h/h_{ef}	2,0	2,2	2,4	2,6	2,8	3,0	3,2	3,4	3,6	$\geq 3,68$
$f_{h,sp} = [h/(2 \cdot h_{ef})]^{2/3}$	1	1,07	1,13	1,19	1,25	1,31	1,37	1,42	1,48	1,5

Influence of reinforcement

Anchor size	6	8				10			14		
Type	HUS-A, H, I, P	H				H			H		
h_{nom}	[mm]	55	50	60	75	60	70	85	70	90	110
h_{ef}	[mm]	42	36	46,9	59,6	44	52,7	66,8	50	67	90
$f_{re,N}^{a)} = 0,5 + h_{ef}/200mm \leq 1$		0,71	0,68	0,73	0,8	0,72	0,76	0,83	0,7	0,84	0,95

a) This factor applies only for dense reinforcement. If in the area of anchorage there is reinforcement with a spacing ≥ 150 mm (any diameter) or with a diameter ≤ 10 mm and a spacing ≥ 100 mm, then a factor $f_{re,N} = 1$ may be applied.

Shear loading

The design shear resistance is the lower value of

- Steel resistance: $V_{Rd,s}$
- Concrete pryout resistance: $V_{Rd,cp} = V_{Rd,cp}^0 \cdot f_B \cdot f_{1,N} \cdot f_{2,N} \cdot f_{3,N} \cdot f_{re,N}$
- Concrete edge resistance: $V_{Rd,c} = V_{Rd,c}^0 \cdot f_B \cdot f_{\beta} \cdot f_h \cdot f_4$

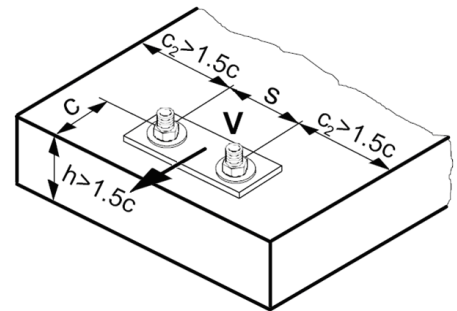

Basic design shear resistance

Design steel resistance $V_{Rd,s}$

		ETA-08/0307			Hilti
Anchor size		HUS-A, H, I, P 6	HUS-H 8	HUS-H 10	HUS-H 14
$V_{Rd,s}$	[kN]	8,3	10,6	15,9	34,1

Design concrete pryout resistance $V_{Rd,cp} = V_{Rd,cp}^0 \cdot f_B \cdot f_{1,N} \cdot f_{2,N} \cdot f_{3,N} \cdot f_{re,N}$

		ETA-08/0307					Hilti				
Anchor size		6	8	8	10	10	8	10	14	14	14
h_{nom}		55	60	75	70	85	50	60	70	90	110
Non-cracked concrete											
$V_{Rd,cp}^0$	[kN]	13,7	21,7	31,2	26,7	36,9	14,5	19,6	23,8	36,9	57,4
Cracked concrete											
$V_{Rd,cp}^0$	[kN]	9,8	15,5	22,3	19,0	26,3	10,4	14,0	-	26,3	-

Design concrete edge resistance $V_{Rd,c} = V_{Rd,c}^0 \cdot f_B \cdot f_{\beta} \cdot f_4$

		ETA-08/0307					Hilti				
Anchor size		6	8	8	10	10	8	10	14	14	14
h_{nom}		55	60	75	70	85	50	60	70	90	110
Non-cracked concrete											
$V_{Rd,c}^0$	[kN]	2,1	2,7	4,1	3,7	5,3	1,7	2,6	3,6	5,9	9,7
Cracked concrete											
$V_{Rd,c}^0$	[kN]	1,5	1,9	3,0	2,6	3,8	1,2	1,9	-	4,2	-

Influencing factors

Influence of concrete strength

Concrete strength designation (ENV 206)	HUS	h_{nom}	C 20/25	C 25/30	C 30/37	C 35/45	C 40/50	C 45/55	C 50/60
$f_B = (f_{ck,cube}/25N/mm^2)^{0,5}$ a)	6	55	1	1,10	1,22	1,34	1,41	1,48	1,55
	8	50...75							
	10	85							
	14	70...110							
$f_B = (f_{ck,cube}/25N/mm^2)^{0,4}$ a)	10	60...70	1	1,08	1,17	1,27	1,32	1,37	1,42

a) $f_{ck,cube}$ = concrete compressive strength, measured on cubes with 150 mm side length

Influence of edge distance a)

$c/c_{cr,N}$	0,1	0,2	0,3	0,4	0,5	0,6	0,7	0,8	0,9	1
$f_{1,N} = 0,7 + 0,3 \cdot c/c_{cr,N} \leq 1$	0,73	0,76	0,79	0,82	0,85	0,88	0,91	0,94	0,97	1
$f_{2,N} = 0,5 \cdot (1 + c/c_{cr,N}) \leq 1$	0,55	0,60	0,65	0,70	0,75	0,80	0,85	0,90	0,95	1

a) The edge distance shall not be smaller than the minimum edge distance c_{min} given in the table with the setting details. These influencing factors must be considered for every edge distance.

Influence of anchor spacing a)

$s/s_{cr,N}$	0,1	0,2	0,3	0,4	0,5	0,6	0,7	0,8	0,9	1
$f_{3,N} = 0,5 \cdot (1 + s/s_{cr,N}) \leq 1$	0,55	0,60	0,65	0,70	0,75	0,80	0,85	0,90	0,95	1

a) The anchor spacing shall not be smaller than the minimum anchor spacing s_{min} given in the table with the setting details. This influence factor must be considered for every anchor spacing.

Influence of reinforcement

Anchor size		6	8				10			14	
Type	HUS-	A, H, I, P	H				H			H	
h_{nom}	[mm]	55	50	60	75	60	70	85	70	90	110
h_{ef}	[mm]	42	36	46,9	59,6	44	52,7	66,8	50	67	90
$f_{re,N}$ a)	$= 0,5 + h_{ef}/200mm \leq 1$	0,71	0,68	0,73	0,8	0,72	0,76	0,83	0,7	0,84	0,95

a) This factor applies only for dense reinforcement. If in the area of anchorage there is reinforcement with a spacing ≥ 150 mm (any diameter) or with a diameter ≤ 10 mm and a spacing ≥ 100 mm, then a factor $f_{re,N} = 1$ may be applied.

Influence of angle between load applied and the direction perpendicular to the free edge

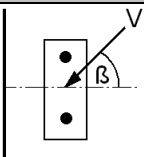
Angle β		0° - 55°	60°	65°	70°	75°	80°	85°	90° - 180°
f_β		1,00	1,07	1,14	1,23	1,35	1,50	1,71	2,00

Influence of base material thickness

h/c	0,15	0,3	0,45	0,6	0,75	0,9	1,05	1,2	1,35	$\geq 1,5$
$f_h = \{h/(1,5 \cdot c)\}^{2/3} \leq 1$	0,22	0,34	0,45	0,54	0,63	0,71	0,79	0,86	0,93	1,00

Influence of anchor spacing and edge distance ^{a)} for concrete edge resistance: f_4

$$f_4 = (c/h_{ef})^{1,5} \cdot (1 + s / [3 \cdot c]) \cdot 0,5$$

c/h _{ef}	Single anchor	Group of two anchors s/h _{ef}														
		0,75	1,50	2,25	3,00	3,75	4,50	5,25	6,00	6,75	7,50	8,25	9,00	9,75	10,50	11,25
0,50	0,35	0,27	0,35	0,35	0,35	0,35	0,35	0,35	0,35	0,35	0,35	0,35	0,35	0,35	0,35	0,35
0,75	0,65	0,43	0,54	0,65	0,65	0,65	0,65	0,65	0,65	0,65	0,65	0,65	0,65	0,65	0,65	0,65
1,00	1,00	0,63	0,75	0,88	1,00	1,00	1,00	1,00	1,00	1,00	1,00	1,00	1,00	1,00	1,00	1,00
1,25	1,40	0,84	0,98	1,12	1,26	1,40	1,40	1,40	1,40	1,40	1,40	1,40	1,40	1,40	1,40	1,40
1,50	1,84	1,07	1,22	1,38	1,53	1,68	1,84	1,84	1,84	1,84	1,84	1,84	1,84	1,84	1,84	1,84
1,75	2,32	1,32	1,49	1,65	1,82	1,98	2,15	2,32	2,32	2,32	2,32	2,32	2,32	2,32	2,32	2,32
2,00	2,83	1,59	1,77	1,94	2,12	2,30	2,47	2,65	2,83	2,83	2,83	2,83	2,83	2,83	2,83	2,83
2,25	3,38	1,88	2,06	2,25	2,44	2,63	2,81	3,00	3,19	3,38	3,38	3,38	3,38	3,38	3,38	3,38
2,50	3,95	2,17	2,37	2,57	2,77	2,96	3,16	3,36	3,56	3,76	3,95	3,95	3,95	3,95	3,95	3,95
2,75	4,56	2,49	2,69	2,90	3,11	3,32	3,52	3,73	3,94	4,15	4,35	4,56	4,56	4,56	4,56	4,56
3,00	5,20	2,81	3,03	3,25	3,46	3,68	3,90	4,11	4,33	4,55	4,76	4,98	5,20	5,20	5,20	5,20
3,25	5,86	3,15	3,38	3,61	3,83	4,06	4,28	4,51	4,73	4,96	5,18	5,41	5,63	5,86	5,86	5,86
3,50	6,55	3,51	3,74	3,98	4,21	4,44	4,68	4,91	5,14	5,38	5,61	5,85	6,08	6,31	6,55	6,55
3,75	7,26	3,87	4,12	4,36	4,60	4,84	5,08	5,33	5,57	5,81	6,05	6,29	6,54	6,78	7,02	7,26
4,00	8,00	4,25	4,50	4,75	5,00	5,25	5,50	5,75	6,00	6,25	6,50	6,75	7,00	7,25	7,50	7,75
4,25	8,76	4,64	4,90	5,15	5,41	5,67	5,93	6,18	6,44	6,70	6,96	7,22	7,47	7,73	7,99	8,25
4,50	9,55	5,04	5,30	5,57	5,83	6,10	6,36	6,63	6,89	7,16	7,42	7,69	7,95	8,22	8,49	8,75
4,75	10,35	5,45	5,72	5,99	6,27	6,54	6,81	7,08	7,36	7,63	7,90	8,17	8,45	8,72	8,99	9,26
5,00	11,18	5,87	6,15	6,43	6,71	6,99	7,27	7,55	7,83	8,11	8,39	8,66	8,94	9,22	9,50	9,78
5,25	12,03	6,30	6,59	6,87	7,16	7,45	7,73	8,02	8,31	8,59	8,88	9,17	9,45	9,74	10,02	10,31
5,50	12,90	6,74	7,04	7,33	7,62	7,92	8,21	8,50	8,79	9,09	9,38	9,67	9,97	10,26	10,55	10,85

a) The anchor spacing and the edge distance shall not be smaller than the minimum anchor spacing s_{min} and the minimum edge distance c_{min} .

Combined tension and shear loading

For combined tension and shear loading see section "Anchor Design".

Precalculated values

Design resistance calculated according ETAG 001, Annex C and data given in ETA-08/0307 issue 2014-04-29. All data applies to concrete C 20/25 – $f_{ck,cube} = 25 \text{ N/mm}^2$.

Recommended loads can be calculated by dividing the design resistance by an overall partial safety factor for action $\gamma = 1,4$. The partial safety factors for action depend on the type of loading and shall be taken from national regulations.

Design resistance

Single anchor, no edge effects

		ETA-08/0307					Hilti					
Anchor size		6	8	8	10	10	8	10	14	14	14	
h_{nom}	[mm]	55	60	75	70	85	50	60	70	90	110	
Base material thickness h_{min}		100	110	120	130	130	100	110	130	170	210	
	Tensile N_{Rd} [kN]											
	Non cracked concrete											
	HUS-H	[kN]	4,2	6,7	8,9	6,7	9,5	4,7	6,7	9,9	15,4	24,0
	Cracked concrete											
HUS-H	[kN]	3,3	3,3	5,0	4,2	7,6	2,2	3,6	-	9,5	-	
	Shear V_{Rd}, without lever arm [kN]											
	Non cracked concrete											
	HUS-H	[kN]	8,3	10,6	10,6	15,9	15,9	10,6	15,9	23,8	34,1	34,1
	Cracked concrete											
HUS-H	[kN]	8,3	10,6	10,6	15,9	15,9	10,6	15,9	-	26,3	-	

Single anchor, min. edge distance ($c = c_{min}$)

		ETA-08/0307					Hilti					
Anchor size		6	8	8	10	10	8	10	14	14	14	
h_{nom}	[mm]	55	60	75	70	85	50	60	70	90	110	
Base material thickness h_{min}		100	110	120	130	130	100	110	130	170	210	
	Tensile N_{Rd} [kN]											
	Non cracked concrete											
	Edge distance c_{min}	[mm]	35	55	55	65	65	55	65	60	60	60
	HUS-H	[kN]	5,1	7,5	9,3	9,4	9,7	6,1	8,1	8,4	10,8	14,4
	Cracked concrete											
Edge distance c_{min}	[mm]	35	50	50	50	50	55	65	-	60	-	
HUS-H	[kN]	3,7	5,0	6,3	5,7	6,0	4,3	5,8	-	7,7	-	
	Shear V_{Rd}, without lever arm [kN]											
	Non cracked concrete											
	Edge distance c_{min}	[mm]	35	55	55	65	65	55	65	60	60	60
	HUS-H	[kN]	2,6	5,1	5,4	6,8	7,1	4,9	6,6	6,3	6,7	7,2
	Cracked concrete											
Edge distance c_{min}	[mm]	35	50	50	50	50	55	65	-	60	-	
HUS-H	[kN]	1,9	3,2	3,3	3,4	3,5	3,5	4,7	-	4,8	-	

Double anchor, no edge effects, min. spacing ($s = s_{min}$),
(load values are valid for one anchor)

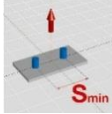
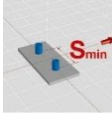
		ETA-08/0307					Hilti					
Anchor size		6	8	8	10	10	8	10	14	14	14	
h_{nom}	[mm]	55	60	75	70	85	50	60	70	90	110	
Base material thickness $h_{min} =$		100	110	120	130	130	100	110	130	170	210	
	Tensile N_{Rd} [kN]											
	Non cracked concrete											
	Spacing s_{min}	[mm]	35	55	55	65	65	55	65	80	80	80
	HUS-H	[kN]	4,9	6,3	8,5	7,8	8,7	4,6	6,1	7,6	10,8	15,5
	Cracked concrete											
	Spacing s_{min}	[mm]	35	40	40	50	50	55	65	-	80	-
HUS-H	[kN]	3,5	4,1	5,7	5,2	5,9	3,3	4,4	-	7,7	-	
	Shear V_{Rd}, without lever arm [kN]											
	Non cracked concrete											
	Spacing s_{min}	[mm]	35	55	55	65	65	55	65	80	80	80
	HUS-H	[kN]	8,3	10,6	10,6	15,9	15,9	10,6	14,7	18,3	25,8	34,1
	Cracked concrete											
	Spacing s_{min}	[mm]	35	40	40	50	50	55	65	-	80	-
HUS-H	[kN]	6,3	9,9	10,6	12,5	15,9	7,8	10,5	-	18,4	-	

HUS 6 Screw anchor, Redundant fastening

	Anchor version	Benefits
	HUS-A 6 Carbon steel Concrete Screw with hex head	<ul style="list-style-type: none"> - Quick and easy setting - Low expansion forces in base materials - Through fastening - Removable - Forged-on washer and hexagon head with no protruding thread
	HUS-H 6 Carbon steel Concrete Screw with hex head	
	HUS-I 6 Carbon steel Concrete Screw with hex head	
	HUS-P 6 Carbon steel Concrete Screw with pan head	
	HUS-HR 6 Stainless steel Concrete Screw	



Concrete



Tensile zone

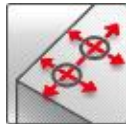

Small edge distance and spacing

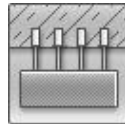

Redundant fastening



Fire resistance

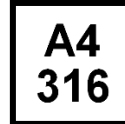

Corrosion Resistance



European Technical Approval



CE conformity

Approvals / certificates

Description	Authority / Laboratory	No. / date of issue
European technical approval ^{a)}	DIBt, Berlin	ETA-10/0005 / 2013-06-26
Fire test report	DIBt, Berlin	ETA-10/0005 / 2013-06-26

a) Data for HUS-HR 6 with nominal embedment depth = 30 mm for multiple use for non-structural applications (= redundant fastening) are not part of ETA-10/0005 issue 2013-06-26

Basic loading data

All data in this section applies to

For details see Simplified design method

- Correct setting (See setting instruction)
- No edge distance and spacing influence
- Concrete C 20/25, $f_{ck,cube} = 25 \text{ N/mm}^2$

The following technical data are based on:

ETA: Data according ETA-05/0005 issue 2013-06-26

Hilti: Additional Hilti technical data

Characteristic resistance

			Hilti tech. data	Data according ETA-10/0005, issue 2013-06-26	
Anchor version			HUS-HR 6		HUS-A, -H, -I, -P 6
Nominal embedment depth	h_{nom}	[mm]	30	35	35
All load directions	$35 \leq c < 80$ mm	F_{Rk}^0	2,0	3,0	2,0
	$c \geq 80$ mm	F_{Rk}^0		5,0	3,0

Design resistance

			Hilti tech. data	Data according ETA-10/0005, issue 2013-06-26	
Anchor version			HUS-HR 6		HUS-A, -H, -I, -P 6
Nominal embedment depth	h_{nom}	[mm]	30	35	35
All load directions	$35 \leq c < 80$ mm	F_{Rd}^0	1,0	1,4	1,3
	$c \geq 80$ mm	F_{Rd}^0		2,4	2,0

Recommended loads

			Hilti tech. data	Data according ETA-10/0005, issue 2013-06-26	
Anchor version			HUS-HR 6		HUS-A, -H, -I, -P 6
Nominal embedment depth	h_{nom}	[mm]	30	35	35
All load directions ^{a)}	$35 \leq c < 80$ mm	F_{Rec}^0	0,7	1,0	0,9
	$c \geq 80$ mm	F_{Rec}^0		1,7	1,4

a) With overall partial safety factor for action $\gamma = 1,4$. The partial safety factors for action depend on the type of loading and shall be taken from national regulations.

Requirements for redundant fastening

The definition of redundant fastening according to Member States is given in the ETAG 001 Part six, Annex 1. In absence of a definition by a Member State the following default values may be taken

Minimum number of fixing points	Minimum number of anchors per fixing point	Maximum design load of action N_{Sd} per fixing point ^{a)}
3	1	2 kN
4	1	3 kN

b) The value for maximum design load of actions per fastening point N_{Sd} is valid in general that means all fastening points are considered in the design of the redundant structural system. The value N_{Sd} may be increased if the failure of one (= most unfavourable) fixing point is taken into account in the design (serviceability and ultimate limit state) of the structural system e.g. suspended ceiling.

Materials

Mechanical properties

Anchor version			HUS-HR 6	HUS-A, -H, -I, -P 6
Nominal tensile strength	f_{uk}	[N/mm ²]	1040	930
Stressed cross-section	A_s	[mm ²]	23	26,9
Moment of resistance	W	[mm ³]	15,5	19,7
Design bending resistance	$M_{Rd,s}$	[Nm]	12,9	14,6

Material quality

Anchor version			HUS-HR 6	HUS-A, -H, -I, -P 6
Material			Stainless steel (grade A4)	Steel, Galvanised $\geq 5 \mu\text{m}$





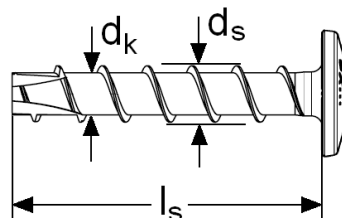

Anchor dimensions

Dimensions

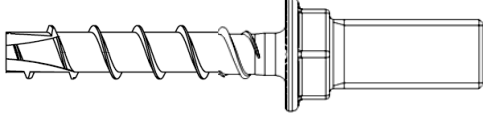
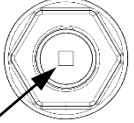
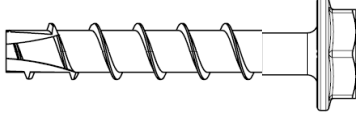
Anchor version			HUS-HR 6	HUS-A 6	HUS-H 6	HUS-I 6	HUS-P 6
Nominal length	l_s	[mm]	35 ... 70	35	40..120	35	40..80
Outer diameter of thread	d_s	[mm]	7,6	7,85			
Core diameter	d_k	[mm]	5,4	5,85			

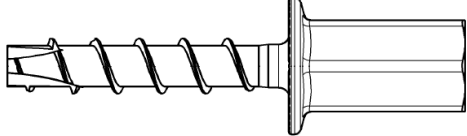
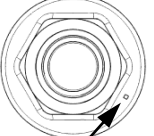
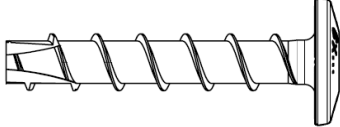

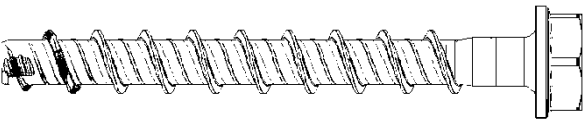
Head configuration

HUS-A 6	External thread M8 or M10		
		Square mark with $d = 2 \text{ mm}$ edge length for $h_{\text{nom}} = 35 \text{ mm}$	
HUS-H 6	Hex head and Torx T30		
HUS-I 6	Internal threads M8 and M10		
		One circle mark with $d = 0.8 \text{ mm}$ for $h_{\text{nom}} = 35 \text{ mm}$	
HUS-P 6	Pan head with		
HUS-HR 6	Hexagon head SW = 13 mm		

Setting

Recommended installation equipment

Anchor size	HUS-HR 6	HUS-A 6	HUS-I 6	HUS-H 6	HUS-P 6
Rotary hammer	Hilti TE 6 / TE 7				
drill bit	TE-CX 6				
Socket wrench insert	S-NSD 13 ½ (L)	S-NSD 13 ½ L	S-NSD 13 ½ (L)		-
Torx	-			T30	
Impact screw driver	See setting instruction				

Setting instruction

HUS-HR 6

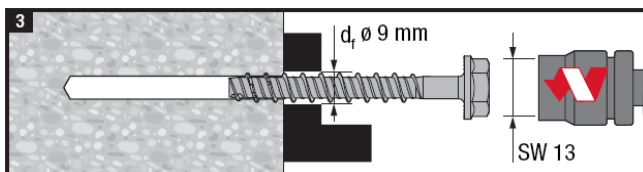
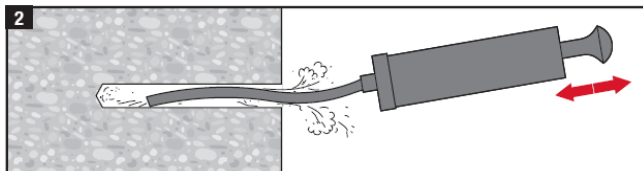
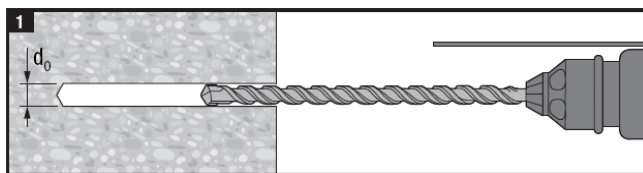
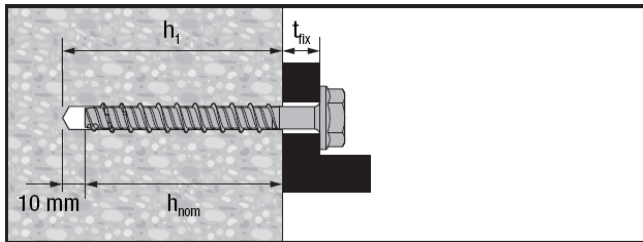

3.1

	h_{nom} 30 mm	35 mm	55 mm	55 mm	55 mm
SIW/SID 121	✓	✓	✓	✗	✗
SIW/SID 144	✓	✓	✓	✗	✗
SIW 22T-A	✗	✗	✗	✗	✗
SI 100	✗	✗	✗	✗	✗
TKI 2500	✓	✓	✓	✗	✗
⊗	✗	✗	✗	12 Nm	6 Nm

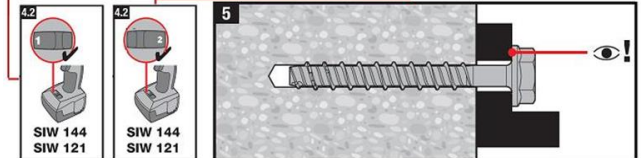

HUS-P 6, HUS-I 6

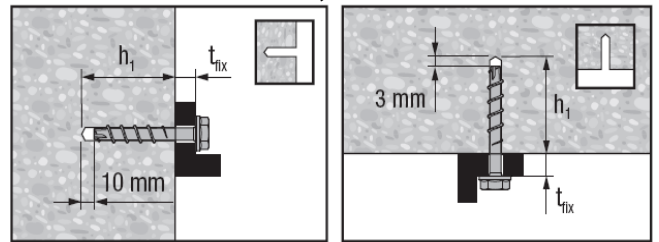

reduced drilling depth
for overhead installation

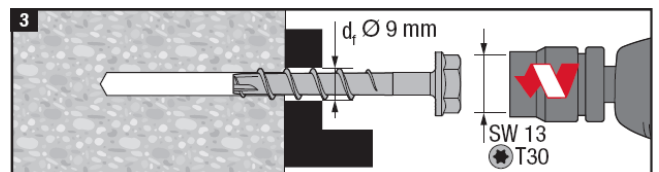
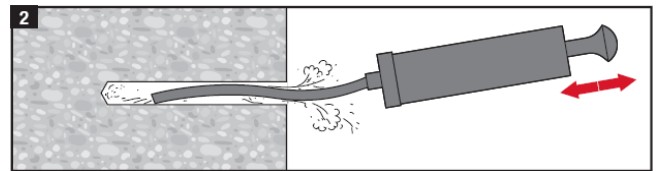
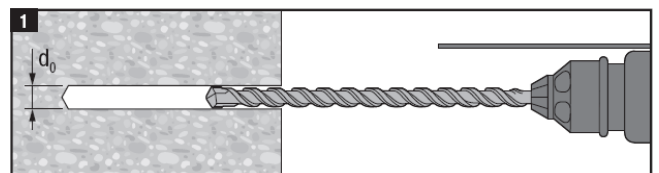

3.1

SIW/SID 121	✓
SIW/SID 144	✓
TKI 2500	✓
⊗	18 Nm

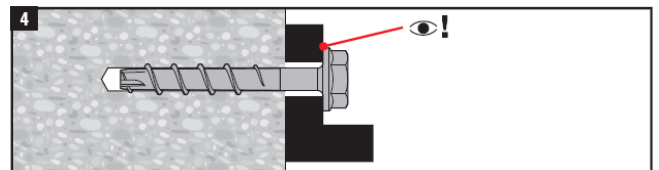

For detailed information on installation see instruction for use given with the package of the product.

Setting details

Anchor version		HUS-HR 6		HUS-A 6	HUS-H 6	HUS-I 6	HUS-P 6
Nominal embedment depth	$h_{nom} \geq$ [mm]	30	35	35			
Nominal diameter of drill bit	d_o [mm]	6					
Cutting diameter of drill bit	$d_{cut} \leq$ [mm]	6,4					
Depth of drill hole	$h_1 \geq$ [mm]	40	45	45			
Depth of drill hole for overhead installation	$h_1 \geq$ [mm]	40	45	38			
Diameter of clearance hole in the fixture	$d_f \leq$ [mm]	9		-	9	-	9
Effective anchorage depth	h_{ef} [mm]	23	27	25			
Nominal length of screw	l_s [mm]	35 ... 70	60 ... 70	35	40 ... 120	35	40 ... 80
Max. fastening thickness	t_{fix} [mm]	$l_s - h_{nom}$		-	$l_s - h_{nom}$	-	$l_s - h_{nom}$
Max. installation torque	T_{inst} [Nm]	- a)		18			

a) Hilti recommends machine setting only

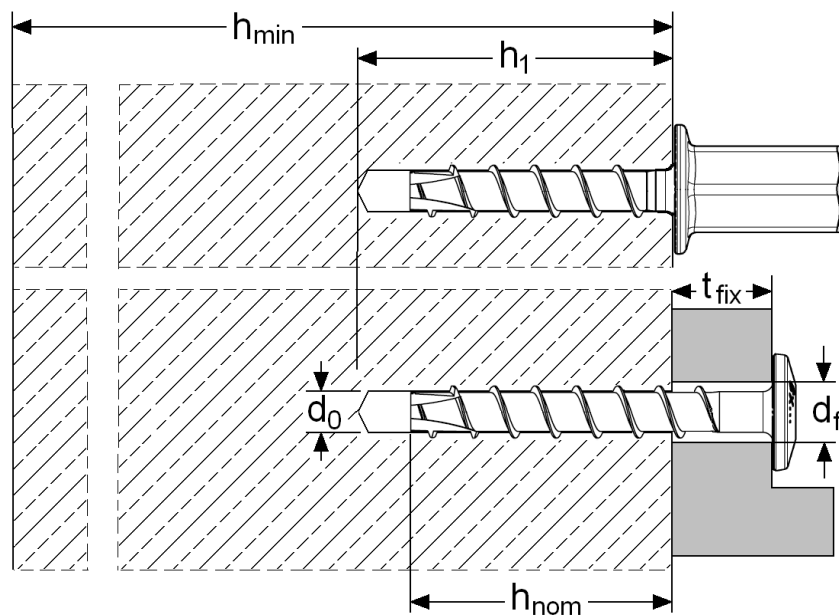

Base material thickness, anchor spacing and edge distance

Anchor version			HUS-HR 6		HUS-A, -H, -I, -P 6
Nominal embedment depth	h_{nom}	[mm]	30	35	35
Effective anchorage depth	h_{ef}	[mm]	23	27	25
Minimum base material thickness	h_{min}	[mm]	80	80	80
Minimum spacing	s_{min}	[mm]	35	35	35
Minimum edge distance	c_{min}	[mm]	35	35 (80) ¹⁾	35 (80) ¹⁾
Critical spacing	s_{cr}	[mm]	3 h_{ef}		
Critical edge distance	c_{cr}	[mm]	1,5 h_{ef}		

¹⁾ see basic loading data

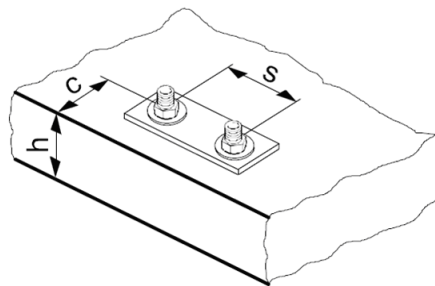

For spacing (edge distance) smaller than critical spacing (critical edge distance) the design loads have to be reduced (see system design resistance).

Simplified design method for multiple use for non-structural applications (= redundant fastening)

Simplified version of the design method according ETAG 001, Annex C. Design resistance according data given in ETA-10/0005 issue 2013-06-26.

- Influence of concrete strength
- Influence of edge distance
- Influence of spacing
- Valid for a group of two anchors. (The method may also be applied for anchor groups with more than two anchors or more than one edge. The influencing factors must then be considered for each edge distance and spacing. The calculated design loads are then on the same side: They will be lower than the exact values according ETAG 001, Annex C.

The design method is based on the following simplification:

- No different loads are acting on individual anchors (no eccentricity)

The values are valid for one anchor.

Design load – all load directions

Design resistance $F_{Rd} = F_{Rd}^0 \cdot f_B \cdot f_1 \cdot f_2 \cdot f_3 \cdot f_{re}$

Basic design resistance

		Hilti tech. data	Data according ETA-10/0005, issue 2013-06-26	
Anchor version		HUS-HR 6		HUS-A, -H, -I, -P 6
Nominal embedment depth	h_{nom} [mm]	30	35	35
Basic design resistance in all load directions	$35 \leq c < 80$ mm	1,0	1,4	1,3
	$c \geq 80$ mm		2,4	2,0

Influencing factors

Influence of concrete strength

Concrete strength designation (ENV 206)	C 20/25	C 25/30	C 30/37	C 35/45	C 40/50	C 45/55	C 50/60
$f_B = (f_{ck,cube}/25N/mm^2)^{0,5}$ ^{a)}	1	1,1	1,22	1,34	1,41	1,48	1,55

a) $f_{ck,cube}$ = concrete compressive strength, measured on cubes with 150 mm side length

Influence of edge distance ^{a)}

c/c_{cr}	0,1	0,2	0,3	0,4	0,5	0,6	0,7	0,8	0,9	1
$f_1 = 0,7 + 0,3 \cdot c/c_{cr} \leq 1$	0,73	0,76	0,79	0,82	0,85	0,88	0,91	0,94	0,97	1
$f_2 = 0,5 \cdot (1 + c/c_{cr}) \leq 1$	0,55	0,60	0,65	0,70	0,75	0,80	0,85	0,90	0,95	1

a) The edge distance shall not be smaller than the minimum edge distance c_{min} given in the table with the setting details. The influencing factors must be considered for every edge distance.

Influence of anchor spacing ^{a)}

s/s_{cr}	0,1	0,2	0,3	0,4	0,5	0,6	0,7	0,8	0,9	1
$f_3 = 0,5 \cdot (1 + s/s_{cr}) \leq 1$	0,55	0,60	0,65	0,70	0,75	0,80	0,85	0,90	0,95	1



a) The anchor spacing shall not be smaller than the minimum anchor spacing s_{min} given in the table with the setting details. This influencing factor must be considered for every anchor spacing.

Influence of reinforcement

h_{nom} [mm]	Dense reinforcement		Standard reinforcement ^{a)}	
	30	35	30	35
$f_{re} = 0,5 + h_{ef}/200mm \leq 1$	0,62	0,63	1	

a) If in the area of anchorage there is reinforcement with a spacing ≥ 150 mm (any diameter) or with a diameter ≤ 10 mm and a spacing ≥ 100 mm, then a factor $f_{re,N} = 1$ may be applied.

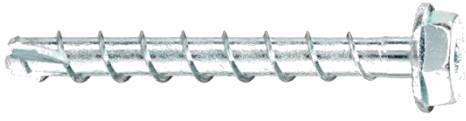
HUS-A 6 / HUS-H 6 / HUS-I 6 / HUS-P 6 Screw anchor in precast prestressed hollow core slabs

	Anchor version	Benefits
	HUS-A 6 Carbon steel Concrete Screw with hex head	<ul style="list-style-type: none"> - Quick and easy setting - Low expansion forces in base materials - Through fastening - Removable - Forged-on washer and hexagon head with no protruding thread
	HUS-H 6 Carbon steel Concrete Screw with hex head	
	HUS-I 6 Carbon steel Concrete Screw with hex head	
	HUS-P 6 Carbon steel Concrete Screw with pan head	



Prestressed hollow core slabs

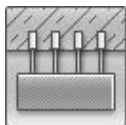

Redundant fastening



European Technical Approval



CE conformity

Approvals / certificates

Description	Authority / Laboratory	No. / date of issue
European technical approval ^{a)}	DIBt, Berlin	ETA-10/0005 / 2013-06-26

a) All data given in this section according ETA-10/0005 issue 2013-06-26.

Basic loading data

All data in this section applies to

- Correct setting (See setting instruction)
- No edge distance and spacing influence
- Ratio core width / web thickness $w/e \leq 4,2$
- Concrete C 30/37 to C 50/60

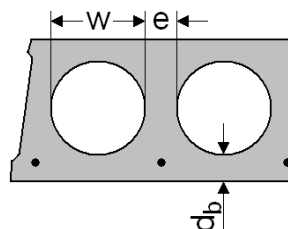

Characteristic resistance

Anchor version			HUS-A, -H, -I, -P 6		
Bottom flange thickness	d_b	[mm]	25	30	35
All load directions	F_{Rk}	[kN]	1,0	2,0	3,0

Design resistance

Anchor version			HUS-A, -H, -I, -P 6		
Bottom flange thickness	d_b	[mm]	25	30	35
All load directions	F_{Rd}	[kN]	0,7	1,3	2,0

Recommended loads

Anchor version			HUS-A, -H, -I, -P 6		
Bottom flange thickness	d_b	[mm]	25	30	35
All load directions ^{a)}	F_{rec}	[kN]	0,5	1,0	1,4

a) With overall partial safety factor for action $\gamma = 1,4$. The partial safety factors for action depend on the type of loading and shall be taken from national regulations.

Requirements for redundant fastening

The definition of redundant fastening according to Member States is given in the ETAG 001 Part six, Annex 1. In absence of a definition by a Member State the following default values may be taken

Minimum number of fixing points	Minimum number of anchors per fixing point	Maximum design load of action N_{Sd} per fixing point ^{a)}
3	1	2 kN
4	1	3 kN

c) The value for maximum design load of actions per fastening point N_{Sd} is valid in general that means all fastening points are considered in the design of the redundant structural system. The value N_{Sd} may be increased if the failure of one (= most unfavourable) fixing point is taken into account in the design (serviceability and ultimate limit state) of the structural system e.g. suspended ceiling.

Materials

Mechanical properties

Anchor version		HUS-A, -H, -I, -P 6
Nominal tensile strength f_{uk}	[N/mm ²]	930
Stressed cross-section A_s	[mm ²]	26,9
Moment of resistance W	[mm ³]	19,7
Design bending resistance $M_{Rd,s}$	[Nm]	14,6

Material quality

Anchor version		HUS-A, -H, -I, -P 6
Material		Carbon steel, galvanised to min. 5 μ m

Anchor dimensions

Anchor version			HUS-A 6	HUS-H 6	HUS-I 6	HUS-P 6
Nominal length	l_s	[mm]	35	40..120	35	60..80
Outer diameter of thread	d_s	[mm]	7,85			
Core diameter	d_k	[mm]	5,85			

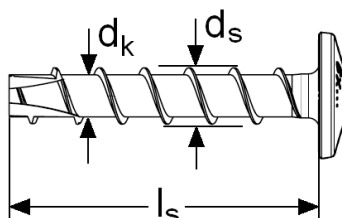

Head configuration

HUS-A 6	External thread M8 or M10		
Square mark with $d = 2$ mm edge length for $h_{nom} = 35$ mm			
HUS-H 6	Hex head and Torx T30		
HUS-I 6	Internal threads M8 and M10		
One circle mark with $d = 0,8$ mm for $h_{nom} = 35$ mm			
HUS-P 6	Pan head with		

Setting

Anchor size	HUS-A 6	HUS-I 6	HUS-H 6	HUS-P 6
Rotary hammer	Hilti TE 6 / TE 7			
drill bit	TE-CX 6			
Socket wrench insert	S-NSD 13 ½ L	S-NSD 13 ½ (L)		-
Torx	-		T30	
Impact screw driver	See setting instruction			

Setting instruction

HUS-A, -H, -I, -P 6 for applications in precast prestressed hollow core slabs

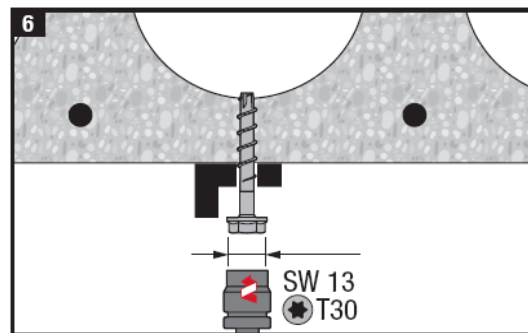
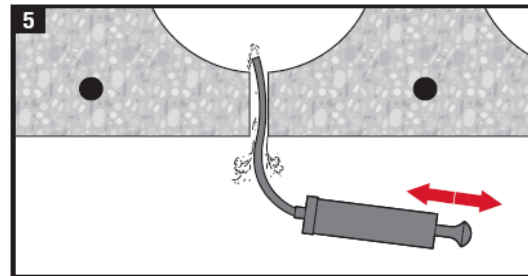
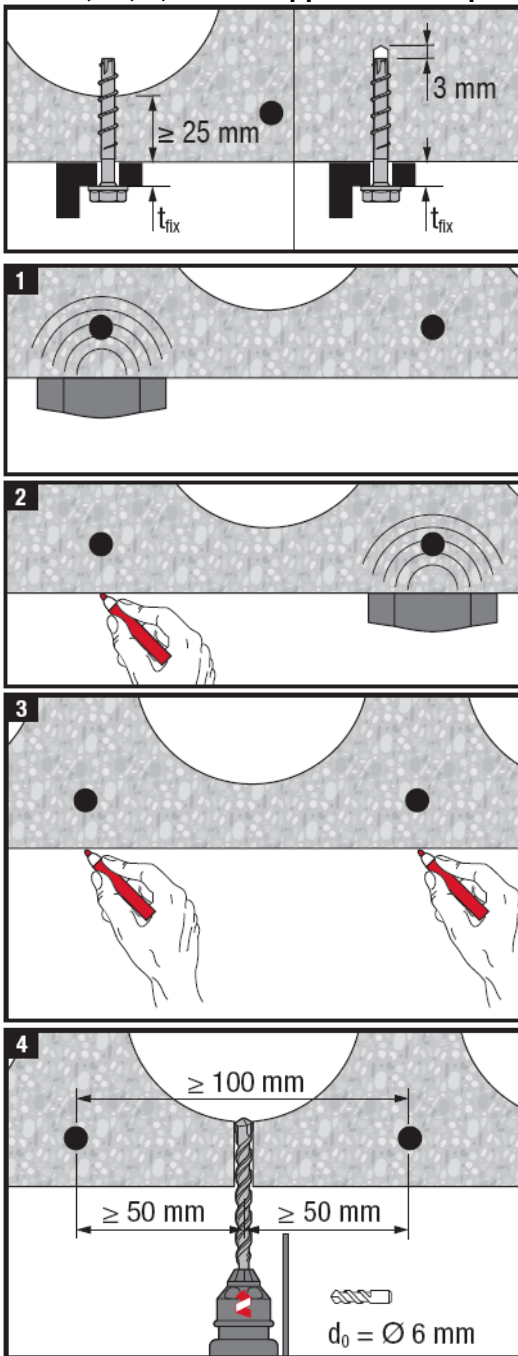

6.1

	SIW/SID 121	✓
	SIW/SID 144	✓
	TKI 2500	✓
		18 Nm

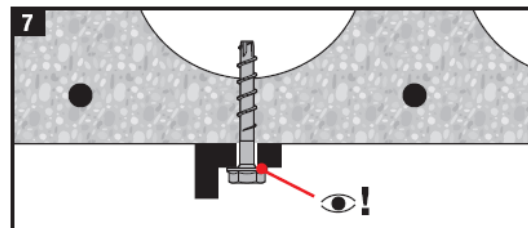

For detailed information on installation see instruction for use given with the package of the product.

Setting details

Anchor version			HUS-A, -H, -P 6					HUS-A, -I 6
Nominal embedment depth	h_{nom}	[mm]	35					
Bottom flange thickness	$d_b \geq$	[mm]	25					
Nominal diameter of drill bit	d_o	[mm]	6					
Cutting diameter of drill bit	$d_{cut} \leq$	[mm]	6,4					
Nominal depth of drill hole ^{a)}	$h_1 \geq$	[mm]	38					
Diameter of clearance hole in the fixture	$d_f \leq$	[mm]	9					-
Nominal effective anchorage depth	h_{ef}	[mm]	25					
Distance between anchor position and prestressing steel	$a_p \geq$	[mm]	50					
Nominal length of screw	l_s	[mm]	40	60	80	100	120	35
Thickness of fixture	$t_{fix} \geq$	[mm]	0	2	5	25	45	-
	$t_{fix} \leq$	[mm]	5	25	45	65	85	-
Max. installation torque	T_{inst}	[Nm]	18					

a) Nominal depth of drill hole may be deeper than bottom flange thickness

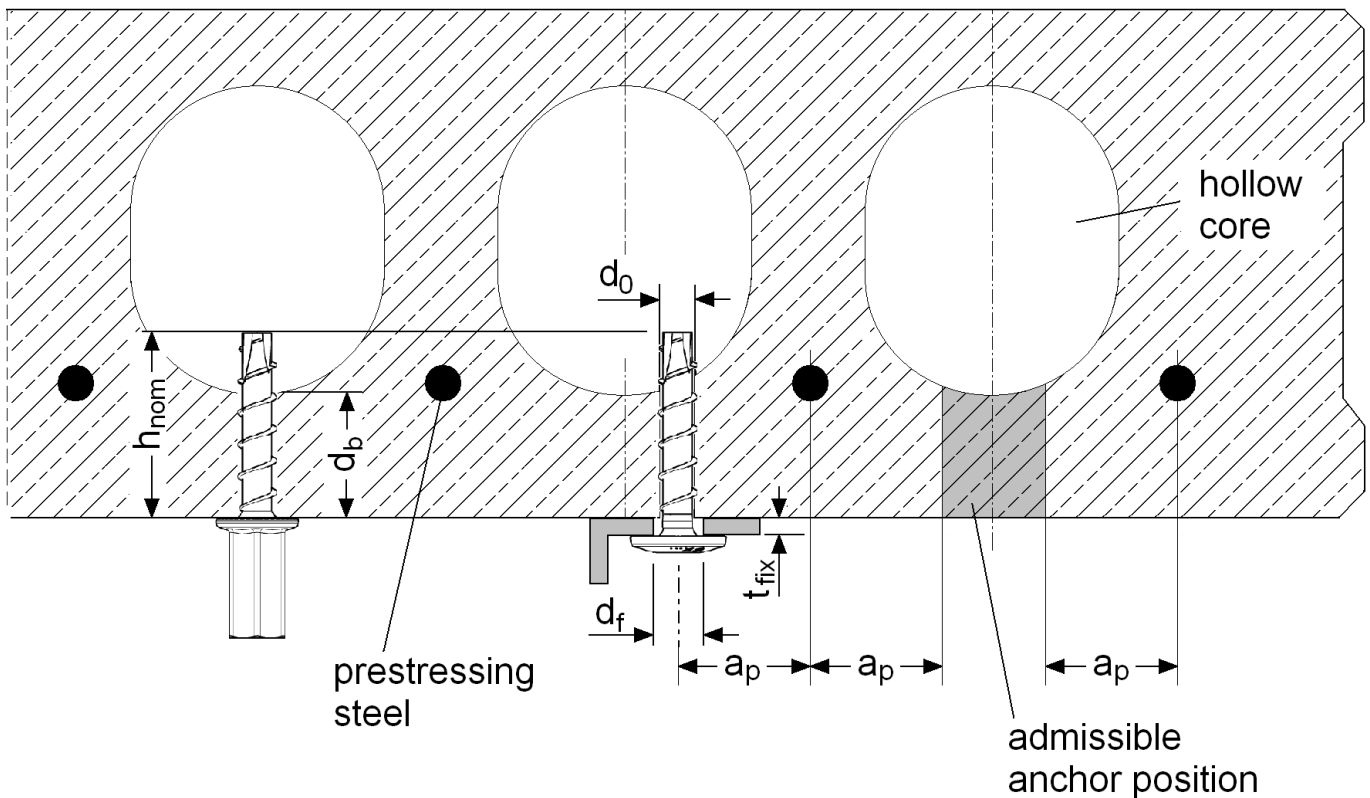

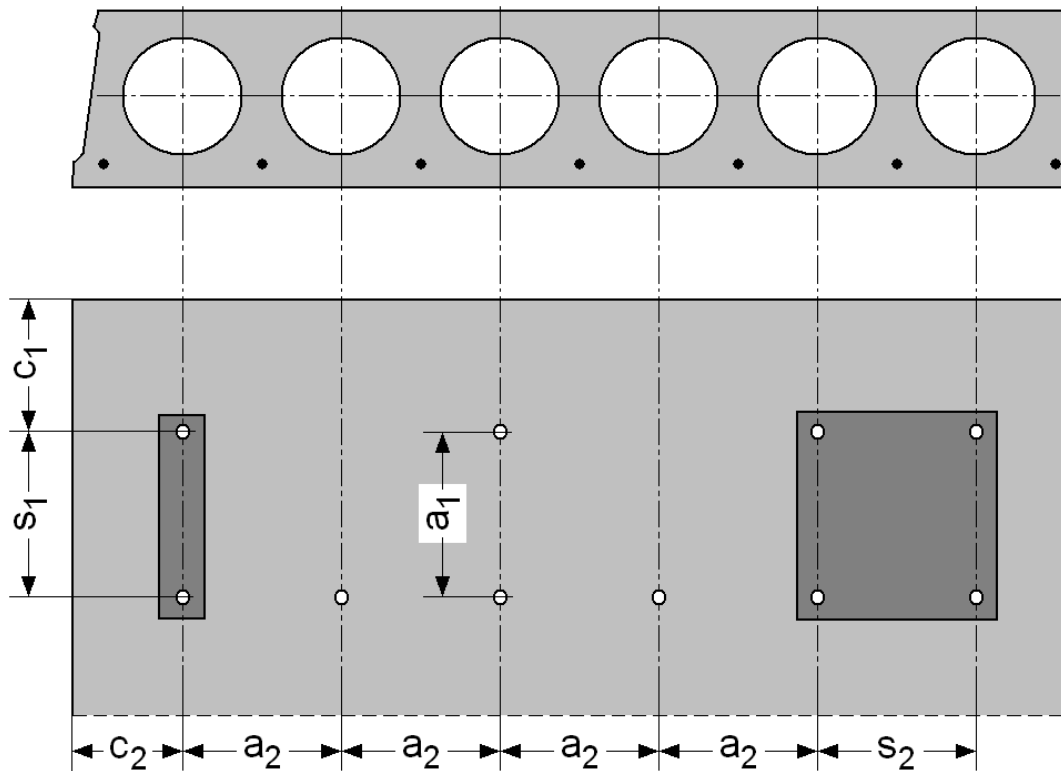

Anchor spacing and edge distance

Anchor version			HUS-A, -H, -I, -P 6
Minimum edge distance	$c_{min} \geq$	[mm]	100
Minimum anchor spacing	$s_{min} \geq$	[mm]	100
Minimum distance between anchor groups	$a_{min} \geq$	[mm]	100



HUS 6 / HUS-S 6 Screw anchor

Anchor version		Benefits
	HUS 6	- Quick and easy setting - Low expansion forces in base materials - Through fastening - Removable
	HUS-S 6	



Concrete

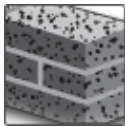

Solid brick

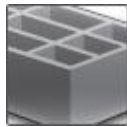

Hollow brick

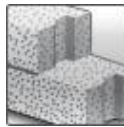

Autoclaved aerated concrete

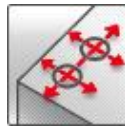

Small edge distance and spacing

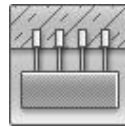

Redundant fastening



Fire resistance

Approvals / certificates

Description	Authority / Laboratory	No. / date of issue
Fire test report	IBMB, Braunschweig DIBt, Berlin	UB 3574/5146 / 2006-05-20
Assessment report (fire)	warringtonfire	WF 327804/A / 2013-07-10

Basic loading data

All data in this section applies to

- Correct setting (See setting instruction)
- No edge distance and spacing influence
- Concrete as specified in the table
- Steel failure
- Concrete C 20/25, $f_{ck,cube} = 25 \text{ N/mm}^2$

Note:

When tightening the screw anchor in soft base materials and in hollow brick, care must be taken not to apply too much torque. If the screw anchor is over-tightened the fastening point is unusable for the HUS 6.

- Solid masonry units:
 - Mz 12 → solid brick, compressive strength 12 N/mm^2 , bulk density $1,8 \text{ N/mm}^2$, format $\geq 240/175/113 \text{ mm}$ (length/width/height)
 - KS 12 → solid lime block, compressive strength 12 N/mm^2 , bulk density $2,0 \text{ N/mm}^2$, format $\geq 240/175/113 \text{ mm}$ (length/width/height)
The core/material ratio in bricks and solid sand lime blocks may not exceed 15% of a bed joint area.
- Autoclaved aerated concrete:
 - PB6 → block, compressive strength 6 N/mm^2 , bulk density $0,6 \text{ N/mm}^2$
 - PB2 → block, compressive strength 2 N/mm^2 , bulk density $0,2 \text{ N/mm}^2$

• Other Limits:

- Applied loads to individual bricks/blocks without compression may not exceed 1,0 kN
- Applied loads to individual bricks/blocks with compression may not exceed 1,4 kN
- Data applies only to bricks/blocks, there is no test data available for loads in mortar joints. Hilti recommends at least a 50% load reduction or on site testing, if the location of the anchor in relation to the joint (see drawing) can not be specified because of wall plaster or insulation.
- Plaster, gravelling, lining or levelling courses are regarded as non-bearing and may not be taken into account for calculation of embedment depth.
- All data is for redundant fastening for non structural applications.

Recommended loads

	concrete C20/25		MZ 20 solid brick ^{b)}	KS sand Lime Block ^{b)}	Hz 0.8/12 Hollow Brick ^{b)}	Aerated concrete							
	Non- cracked	Cracked ^{a)}				PB2 / PB4 ^{c)}		PB6					
Anchor size	HUS 6		HUS 6	HUS 6	HUS 6		HUS 6						
h_{nom} [mm]	34		44	44	64		64						
Edge distance $c \geq$ [mm]	60	30	100	60	30	60	30	60	30	60	30	60	30
Tensile $N_{rec}^{d)}$ [kN]	1,0	1,0	0,5	0,2	0,2	1,0	1,0	0,1	0,1	0,2	0,2	0,2	0,2
Shear $V_{rec}^{d)}$ [kN]	1,6	0,5	0,5	0,4	0,3	1,1	0,4	0,4	0,2	0,3	0,1	0,6	0,2

a) Redundant fastening

b) Holes must be drilled using rotary action only (no hammering action)

c) No anchor hole drilling required in PB2/PB4 gas aerated concrete

d) With overall partial safety factor for action $\gamma = 1,4$. The partial safety factors for action depend on the type of loading and shall be taken from national regulations.

Materials

Mechanical properties

Anchor size	HUS 6 / HUS-S 6
Nominal tensile strength f_{uk} [N/mm ²]	1000
Yield strength f_{yk} [N/mm ²]	900
Stressed cross-section A_s [mm ²]	5,2
Moment of resistance W [mm ³]	13,8
Design bending resistance $M_{Rd,s}$ [Nm]	11

Material quality

Part	Material
Screw anchor	Carbon Steel, galvanised to min. 5 μ m

Anchor dimensions

Dimensions

Anchor version	l_s [mm]	d_k [mm]	d [mm]
HUS 6	35..220	5,3	7,5
HUS-S 6	100..220		7,5

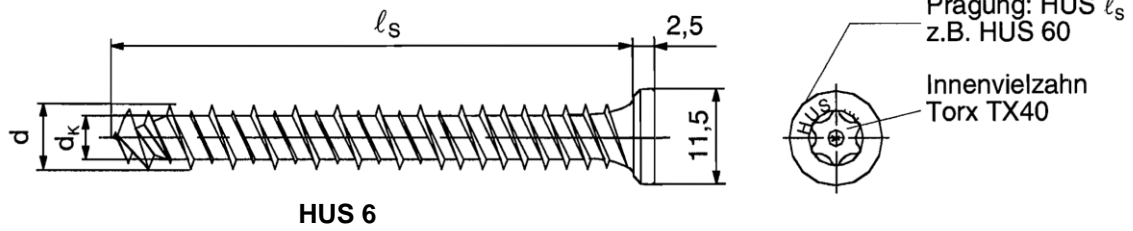

Head configuration HUS-S

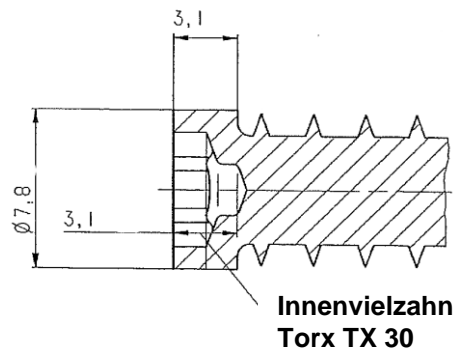

Setting

Recommended installation equipment

Anchor size	HUS 6		HUS-S 6
Rotary hammer	TE 6 / TE 7		
Drill bit	TE-C3X 6/17		
Recommended Setting Tool	SID/SIW 121, SID/SIW 144, TKI 2500		
Accessories	S-B TXI 40 bit		S-B TXI 30 bit

Setting instruction

HUS:

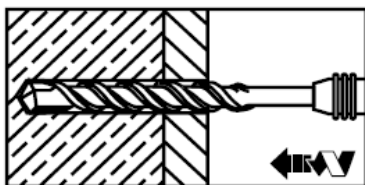

Drill hole with drill bit.

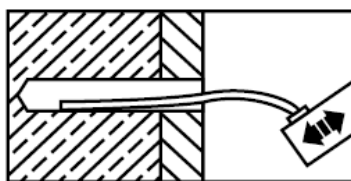

Blow out dust and fragments.

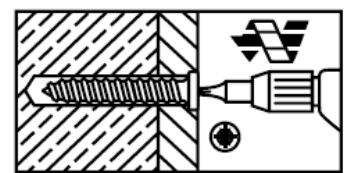

Install anchor with an electric screwdriver.

HUS-S:

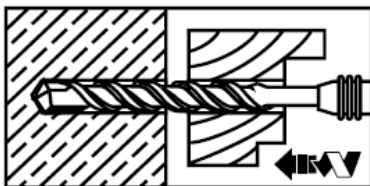

Drill hole with drill bit.

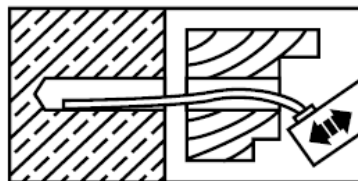

Blow out dust and fragments.

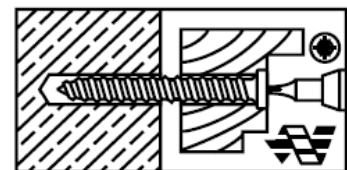

Install anchor with an electric screwdriver.

For detailed information on installation see instruction for use given with the package of the product.

Setting details: depth of drill hole h_1 and effective anchorage depth h_{ef}

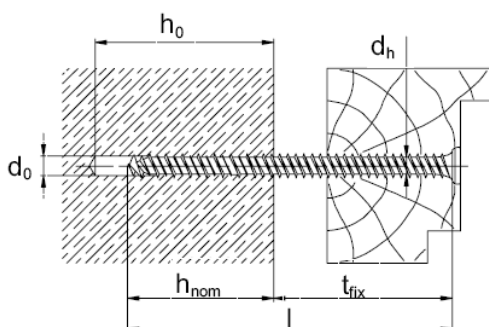

HUS

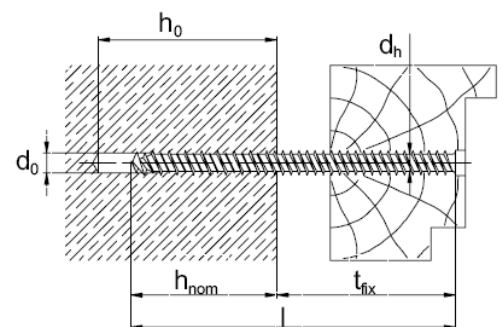

HUS-S

Setting details

		[mm]	C20/25 Concrete	MZ 20 Brick/ KS 12 Block	Hollow Brick	Aerated Concrete	
						PB2/PB4	PB6
Nominal embedment depth	h_{nom}	[mm]	34	44	64	64	64
Nominal diameter of drill bit	d_o	[mm]	6	6	6	-	6
Cutting diameter of drill bit	$d_{cut} \leq$	[mm]	6,4	6,4	6,4	-	6,4
Minimum depth of drill hole	$h_1 \geq$	[mm]	50	54 ^{b)}	64 ^{a)}	- ^{b)}	70
Diameter of clearance hole in the fixture to clamp a fixture	$d_f \leq$	[mm]	8,5				
Diameter of clearance hole in the fixture for stand-off applications	$d_f \leq$	[mm]	6,2				
Max. fastening thickness	t_{fix}	[mm]	$l_s - h_{nom}$				
Max. installation torque	T_{inst}	[Nm]	10	4	2	2	2

a) Holes must be drilled using rotary action only (no hammering action)

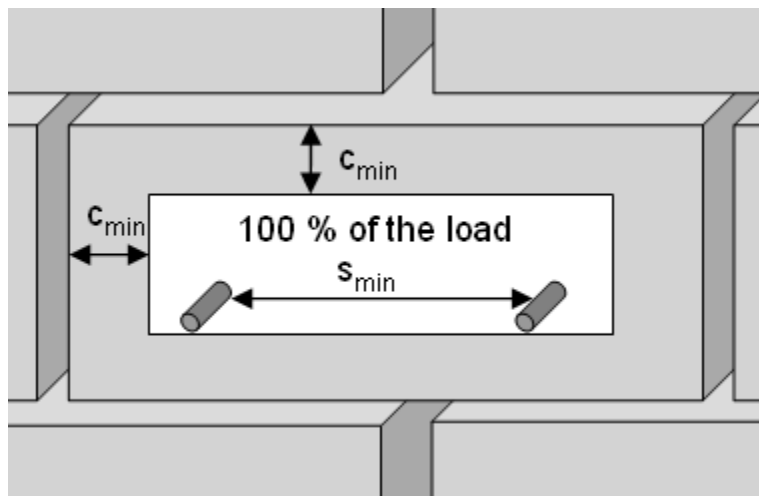

b) No anchor hole drilling required in PB2/PB4 gas aerated concrete

Permissible anchor location in brick and block walls



- Distance to free edge free edge to solid masonry (Mz and KS) units ≥ 200 mm
- Distance to free edge free edge to solid masonry (HLz and autoclaved aerated gas concrete) units ≥ 170 mm
- The minimum distance to horizontal and vertical mortar joint (c_{min}) is stated in the recommended load table.
- Data applies only to bricks/blocks, there is no test data available for loads in mortar joints. Hilti recommends at least a 50% load reduction or on site testing, if the location of the anchor in relation to the joint (see drawing) can not be specified because of wall plaster or insulation.
- Minimum anchor spacing (s_{min}) in one brick/block is $\geq 2 \cdot c_{min}$

HKD Push-in anchor, Single anchor application

	Anchor version	Benefits
	HKD Carbon steel with lip	<ul style="list-style-type: none"> - simple and well proven - approved, tested and confirmed by everyday jobsite experience - reliable setting thanks to simple visual check - versatile - for medium-duty fastening with bolts or threaded rods - available in various materials and sizes for maximized coverage of possible applications
	HKD-S(R) Carbon steel, stainless steel with lip	
	HKD-E(R) Carbon steel, stainless steel without lip	



Concrete



Corrosion
resistance



European
Technical
Approval



CE
conformity



PROFIS
Anchor design
software

Approvals / certificates

Description	Authority / Laboratory	No. / date of issue
European technical approval ^{a)}	DIBt, Berlin	ETA-02/0032 / 2012-10-18

a) Anchors with anchorage depth $h_{ef} = 25\text{mm}$ are not covered by ETA

Basic loading data (for a single anchor)

All data in this section applies to

- Correct setting (See setting instruction)
- No edge distance and spacing influence
- Concrete as specified in the table
- Steel failure
- Minimum base material thickness
- Concrete C 20/25, $f_{ck,cube} = 25\text{ N/mm}^2$
- screw or rod with steel strength 5.8 (carbon steel) and/or A4-70 (stainless steel)

For details see Simplified design method

Mean Ultimate Resistance

Anchor size		Hilti technical data											
		M6x25	M8x25	M10x25	M12x25	M6x30	M8x30	M8x40	M10x30	M10x40	M12x50	M16x65	M20x80
Tensile $N_{Ru,m}$													
HKD	[kN]	8,4	8,4	8,4	8,4	-	11,0	13,1	11,0	17,0	23,8	32,9	48,1
HKD-S, HKD-E	[kN]	8,2	-	-	-	10,6	10,8	16,6	10,8	16,6	23,3	34,5	47,1
HKD-SR, HKD-ER	[kN]	8,2	-	-	-	10,6	10,8	-	-	16,6	23,3	34,5	47,1
Shear $V_{Ru,m}$													
HKD	[kN]	5,5	6,9	6,9	6,9	-	9,4	10,1	11,0	12,2	20,1	37,1	53,9
HKD-S, HKD-E	[kN]	6,5	-	-	-	6,5	9,1	9,1	9,6	10,4	18,3	28,5	45,1
HKD-SR, HKD-ER	[kN]	8,3	-	-	-	7,0	10,9	-	-	13,7	24,3	41,7	66,3

Characteristic Resistance

Anchor size		Hilti technical data				according ETA-02/0032, issue 2012-10-18							
		M6x25	M8x25	M10x25	M12x25	M6x30	M8x30	M8x40	M10x30	M10x40	M12x50	M16x65	M20x80
Tensile N_{Rk}													
HKD	[kN]	6,3	6,3	6,3	6,3	-	8,3	9,0	8,3	12,8	17,8	26,4	36,1
HKD-S, HKD-E	[kN]	6,3	-	-	-	8,3	8,3	9,0	8,3	12,8	17,8	26,4	36,1
HKD-SR, HKD-ER	[kN]	6,3	-	-	-	8,3	8,3	-	-	12,8	17,8	26,4	36,1
Shear V_{Rk}													
HKD	[kN]	5,0	6,3	6,3	6,3	-	8,6	9,2	10,0	11,0	18,3	33,8	49,0
HKD-S, HKD-E	[kN]	5,0	-	-	-	5,0	7,0	7,0	7,4	8,0	14,1	21,9	34,7
HKD-SR, HKD-ER	[kN]	6,2	-	-	-	6,4	8,4	-	-	10,5	18,7	32,1	51,0

Design Resistance

Anchor size		Hilti technical data				according ETA-02/0032, issue 2012-10-18							
		M6x25	M8x25	M10x25	M12x25	M6x30	M8x30	M8x40	M10x30	M10x40	M12x50	M16x65	M20x80
Tensile N_{Rd}													
HKD	[kN]	4,2	4,2	4,2	4,2	-	5,5	6,0	5,5	8,5	11,9	17,6	24,0
HKD-S, HKD-E	[kN]	3,0	-	-	-	4,6	4,6	5,0	4,6	7,1	9,9	17,6	24,0
HKD-SR, HKD-ER	[kN]	3,0	-	-	-	4,6	4,6	-	-	7,1	9,9	17,6	24,0
Shear V_{Rd}													
HKD	[kN]	4,0	4,2	4,2	4,2	-	6,9	7,3	8,0	8,8	14,6	27,0	39,4
HKD-S, HKD-E	[kN]	3,9	-	-	-	3,9	5,5	5,5	5,9	6,4	11,3	17,5	27,8
HKD-SR, HKD-ER	[kN]	4,1	-	-	-	4,2	5,5	-	-	6,9	12,3	21,1	33,6

Recommended load

Anchor size	Hilti technical data				according ETA-02/0032, issue 2012-10-18							
	M6x25	M8x25	M10x25	M12x25	M6x30	M8x30	M8x40	M10x30	M10x40	M12x50	M16x65	M20x80
Tensile N_{rec}^a												
HKD [kN]	3,0	3,0	3,0	3,0	-	3,9	4,3	3,9	6,1	8,5	12,6	17,2
HKD-S, HKD-E [kN]	2,1	-	-	-	3,3	3,3	3,6	3,3	5,1	7,1	12,6	17,2
HKD-SR, HKD-ER [kN]	2,1	-	-	-	3,3	3,3	-	-	5,1	7,1	12,6	17,2
Shear V_{rec}^a												
HKD [kN]	2,9	3,0	3,0	3,0	-	4,9	5,2	5,7	6,3	10,5	19,3	28,3
HKD-S, HKD-E [kN]	2,8	-	-	-	2,8	3,9	4,2	3,9	4,6	8,1	12,5	19,8
HKD-SR, HKD-ER [kN]	2,9	-	-	-	3,0	3,9	-	-	4,9	8,8	15,1	24,0

a) With overall partial safety factor for action $\gamma = 1,4$. The partial safety factors for action depend on the type of loading and shall be taken from national regulations.

Materials

Mechanical properties of HKD, HKD-S, HKS-E, HKD-SR and HKD-ER

Anchor size			M6	M8	M10	M12	M16	M20
Nominal tensile strength f_{uk}	HKD [N/mm ²]		570	570	570	570	640	590
	HKD-S [N/mm ²]		560	560	510	510	-	460
	HKD-E [N/mm ²]							
Yield strength f_{yk}	HKD-SR [N/mm ²]		540	540	540	540	-	540
	HKD-E [N/mm ²]							
	HKD-SR [N/mm ²]		355	355	355	355	-	355
Stressed cross-section A_s	HKD [mm ²]		20,7	26,7	32,7	60,1	105	167
	HKD-S (R) [mm ²]		20,9	26,1	28,8	58,7	-	163
Moment of resistance W	HKD [mm ³]		32,3	54,6	82,9	184	431	850
	HKD-E (R) [mm ³]		50	79	110	264	602	1191
Char. bending resistance for rod or bolt $M_{Rk,s}^0$ [Nm]	With 5.8 Gr. Steel		7,6	18,7	37,4	65,5	167	325
	HKD-SR [Nm]		11	26	52	92	187	454
	HKD-ER with A4-70							

Material quality

Part		Material
Anchor Body	HKD	Steel Fe/Zn5 galvanised to min. 5 µm
	HKD-S HKD-E	Steel Fe/Zn5 galvanised to min. 5 µm
	HKD-SR HKD-ER	Stainless steel, 1.4401, 1.4404, 1.4571
Tapered expansion plug	HKD	Steel material
	HKD-S HKD-E	Steel material
	HKD-SR HKD-ER	Stainless steel, 1.4401, 1.4404, 1.4571

Anchor dimensions

Anchor size Anchor version			M6x25	M8x25	M10x25	M12x25	M6x30	M8x30	M8x40	M10x30	M10x40	M12x50	M16x65	M20x80
Effective anchorage depth	h_{ef}	[mm]	25	25	25	25	30	30	40	30	40	50	60	80
Anchor diameter	d_1	[mm]	7,9	9,95	11,9	14,9	8	9,95	9,95	11,8	11,95	14,9	19,75	24,75
Plug diameter	d_2	[mm]	5,1	6,35	8,1	9,7	5	6,5	6,35	8,2	8,2	10,3	13,8	16,4
Plug length	l_1	[mm]	10	7	7	7,2	15	12	16	12	16	20	29	30

Anchor body

HKD

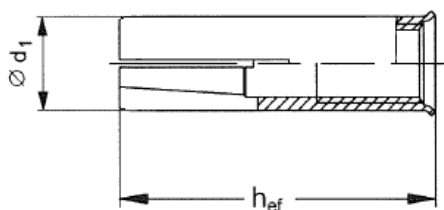

HKD-S and HKD-SR

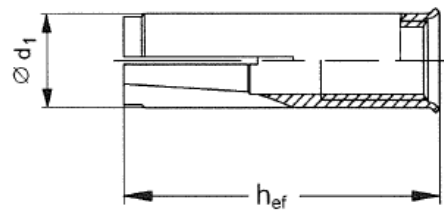

HKD-E and HKD ER

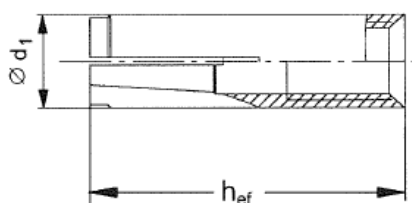

Expansions plugs

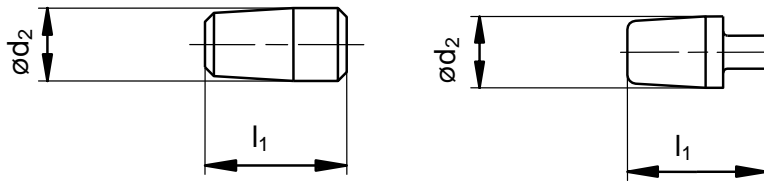

Setting

Installation equipment

Anchor size	M6x25	M6x30	M8x25	M8x30	M8x40	M10x25	M10x30	M10x40	M12x25	M12x50	M16x65	M20x80
Rotary hammer	TE 2 – TE 16										TE 40 – 80	
Machine setting tool HSD-M	6x25/30	8x25/30	8x40	10x25/30	10x40	12x25	12x50	16x65	20x80			
Hand Setting tool HSD-G												
Other tools	hammer, torque wrench, blow out pump											

Setting instruction

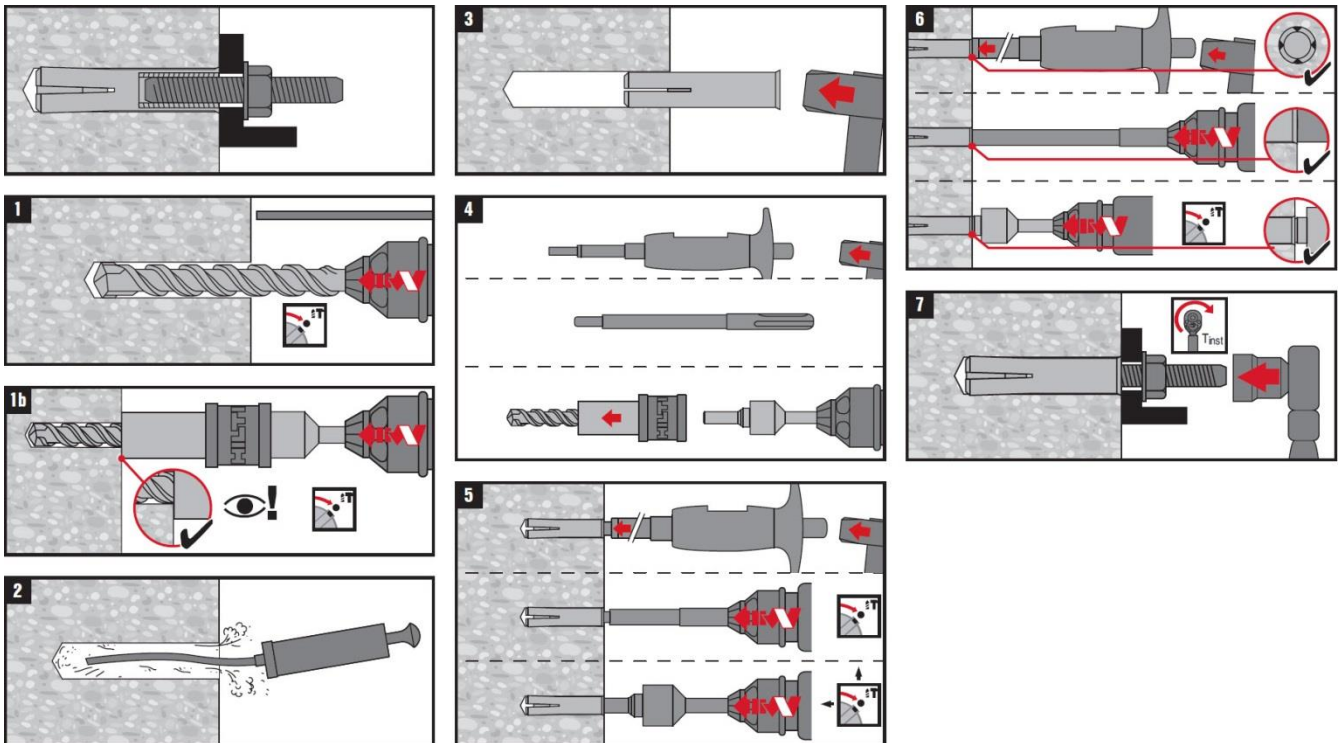

For detailed information on installation see instruction for use given with the package of the product.

For technical data for anchors in diamond drilled holes please contact the Hilti Technical advisory service.

Setting details: depth of drill hole h_1 and effective anchorage depth h_{ef}

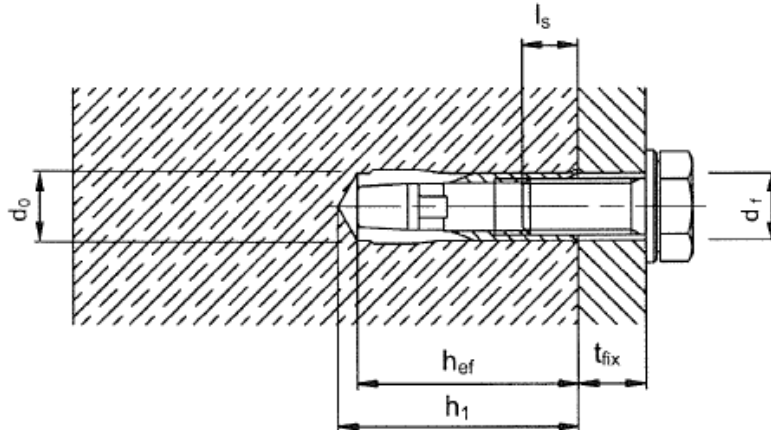

Setting details

Anchor size		M6x25	M8x25	M10x25	M12x25	M6x30	M8x30	M8x40	M10x30	M10x40	M12x50	M16x65	M20x80
Nominal diameter of drill bit	d_o [mm]	8	10	12	15	8	10	10	12	12	15	20	25
Cutting diameter of drill bit	$d_{cut} \leq$ [mm]	8,45	10,5	12,5	15,5	8,45	10,5	10,5	12,5	12,5	15,5	20,5	25,5
Depth of drill hole	$h_1 \geq$ [mm]	27	27	27	27	32	33	43	33	43	54	70	85
Screwing depth	$l_{s,min}$ [mm]	6	8	10	12	6	8	8	10	10	12	16	20
	$l_{s,max}$ [mm]	12	11,5	12	12	12,5	14,5	17,5	13	18	22	30,5	42
Diameter of clearance hole in the fixture	$d_f \leq$ [mm]	7	9	12	14	7	9	9	12	12	14	18	22
Effective anchorage depth	h_{ef} [mm]	25	25	25	25	30	30	40	30	40	50	65	80
Max. torque moment	T_{inst} [Nm]	4	8	15	35	4	8	8	15	15	35	60	120

Base material thickness, anchor spacing and edge distances

Anchor size			M6x25 M8x25 M10x25 M12x25	M6x30 M8x30 M10x30	M8x40 M10x40	M12x50	M16x65	M20x80	
Minimum base material thickness	h_{min}	[mm]	100	100	100	100	130	160	
Minimum spacing and minimum edge distance HKD-S (R) HKD-E (R)	s_{min}	[mm]	60	60	80	125	130	160	
	c_{min}	[mm]	88	105	140	175	230	280	
Minimum spacing HKD	s_{min}	[mm]	80	60	80	125	130	160	
	for $c \geq$	[mm]	140	105	140	175	230	280	
Minimum edge distance HKD	c_{min}	[mm]	100	80	140	175	230	280	
	for $s \geq$	[mm]	150	120	80	125	130	160	
Critical spacing and edge distance for concrete cone failure	$s_{cr,N}$	[mm]	80	90	120	150	200	240	
	$c_{cr,N}$	[mm]	40	45	60	75	100	120	
Critical spacing and edge distance for splitting failure	HKD	$s_{cr,sp}$	[mm]	200	210	280	350	455	560
		$c_{cr,sp}$	[mm]	100	105	140	175	227	280
	HKD-S (R) HKD-E (R)	$s_{cr,sp}$	[mm]	176	210	280	350	455	560
		$c_{cr,sp}$	[mm]	88	105	140	175	227	280

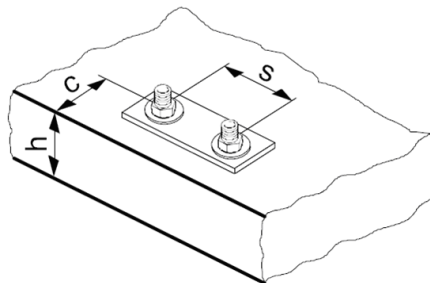

For spacing (edge distance) smaller than critical spacing (critical edge distance) the design loads have to be reduced.

Simplified design method

Simplified version of the design method according ETAG 001, Annex C. Design resistance according data given in ETA-02/0032, issue 2012-10-18.

- Influence of concrete strength
- Influence of edge distance
- Influence of spacing
- Valid for a group of two anchors. (The method may also be applied for anchor groups with more than two anchors or more than one edge. The influencing factors must then be considered for each edge distance and spacing. The calculated design loads are then on the safe side: They will be lower than the exact values according ETAG 001, Annex C. To avoid this, it is recommended to use the anchor design software PROFIS anchor)

The design method is based on the following simplification:

- No different loads are acting on individual anchors (no eccentricity)

The values are valid for one anchor.

For more complex fastening applications please use the anchor design software PROFIS Anchor.

Tension loading

The design tensile resistance is the lower value of

- Steel resistance: $N_{Rd,s}$
- Concrete pull-out resistance: $N_{Rd,p} = N_{Rd,p}^0 \cdot f_B$
- Concrete cone resistance: $N_{Rd,c} = N_{Rd,c}^0 \cdot f_B \cdot f_{1,N} \cdot f_{2,N} \cdot f_{3,N} \cdot f_{re,N}$
- Concrete splitting resistance (only non-cracked concrete):
 $N_{Rd,sp} = N_{Rd,c}^0 \cdot f_B \cdot f_{1,sp} \cdot f_{2,sp} \cdot f_{3,sp} \cdot f_{h,sp} \cdot f_{re,N}$

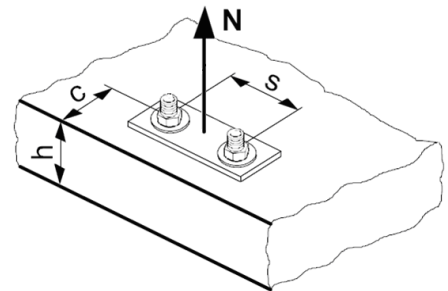

Basic design tensile resistance

Design steel resistance $N_{Rd,s}$ for HKD / HKD-E/S Steel Strength 5.8 and for HKD-ER/SR A4-70

Anchor size			Hilti technical data				according ETA-02/0032, issue 2012-10-18							
			M6x25	M8x25	M10x25	M12x25	M6x30	M8x30	M8x40	M10x30	M10x40	M12x50	M16x65	M20x80
$N_{Rd,s}$	HKD	[kN]	6,7	10,3	12,6	23,6	-	11,4	12,2	13,3	14,7	24,4	45,0	65,3
	HKD-S, HKD-E	[kN]	6,7	-	-	-	6,7	11,4	11,4	12,4	13,4	23,7	37,2	59,1
	HKD-SR, HKD-ER	[kN]	6,9	-	-	-	7,0	9,2	-	-	11,5	20,4	35,1	55,7

Design pull-out resistance $N_{Rd,p} = N_{Rd,p}^0 \cdot f_B$

Anchor size			Non-cracked concrete											
			Hilti technical data				according ETA-02/0032, issue 2012-10-18							
			M6x25	M8x25	M10x25	M12x25	M6x30	M8x30	M8x40	M10x30	M10x40	M12x50	M16x65	M20x80
$N_{Rd,p}^0$	HKD	[kN]	-	-	-	-	-	-	6,0	-	-	-	-	-
	HKD-S, HKD-E	[kN]	-	-	-	-	-	-	5,0	-	-	-	-	-
	HKD-SR, HKD-ER	[kN]	-	-	-	-	-	-	-	-	-	-	-	-

Design concrete cone resistance $N_{Rd,c} = N_{Rd,c}^0 \cdot f_B \cdot f_{1,N} \cdot f_{2,N} \cdot f_{3,N} \cdot f_{re,N}$

Design splitting resistance^{a)} $N_{Rd,sp} = N_{Rd,c}^0 \cdot f_B \cdot f_{1,sp} \cdot f_{2,sp} \cdot f_{3,sp} \cdot f_{h,sp} \cdot f_{re}$

Anchor size			Non-cracked concrete											
			Hilti technical data				according ETA-02/0032, issue 2012-10-18							
			M6x25	M8x25	M10x25	M12x25	M6x30	M8x30	M8x40	M10x30	M10x40	M12x50	M16x65	M20x80
$N_{Rd,c}^0$	HKD	[kN]	4,2	4,2	4,2	4,2	-	5,5	8,5	5,5	8,5	11,9	17,6	24,0
	HKD-S, HKD-E	[kN]	3,0	-	-	-	4,6	4,6	7,1	4,6	7,1	9,9	17,6	24,0
	HKD-SR, HKD-ER	[kN]	3,0	-	-	-	4,6	4,6	-	-	7,1	9,9	17,6	24,0

a) Splitting resistance must only be considered for non-cracked concrete

Influencing factors

Influence of concrete strength

Concrete strength designation (ENV 206)	C 20/25	C 25/30	C 30/37	C 35/45	C 40/50	C 45/55	C 50/60
$f_B = (f_{ck,cube}/25N/mm^2)^{1/2}$ a)	1	1,1	1,22	1,34	1,41	1,48	1,55

a) $f_{ck,cube}$ = concrete compressive strength, measured on cubes with 150 mm side length

Influence of edge distance^{a)}

$c/c_{cr,N}$	0,1	0,2	0,3	0,4	0,5	0,6	0,7	0,8	0,9	1
$c/c_{cr,sp}$										
$f_{1,N} = 0,7 + 0,3 \cdot c/c_{cr,N} \leq 1$	0,73	0,76	0,79	0,82	0,85	0,88	0,91	0,94	0,97	1
$f_{1,sp} = 0,7 + 0,3 \cdot c/c_{cr,sp} \leq 1$										
$f_{2,N} = 0,5 \cdot (1 + c/c_{cr,N}) \leq 1$	0,55	0,60	0,65	0,70	0,75	0,80	0,85	0,90	0,95	1
$f_{2,sp} = 0,5 \cdot (1 + c/c_{cr,sp}) \leq 1$										

a) The edge distance shall not be smaller than the minimum edge distance c_{min} given in the table with the setting details. These influencing factors must be considered for every edge distance.

Influence of anchor spacing ^{a)}

$s/s_{cr,N}$	0,1	0,2	0,3	0,4	0,5	0,6	0,7	0,8	0,9	1
$s/s_{cr,sp}$										
$f_{3,N} = 0,5 \cdot (1 + s/s_{cr,N}) \leq 1$										
$f_{3,sp} = 0,5 \cdot (1 + s/s_{cr,sp}) \leq 1$	0,55	0,60	0,65	0,70	0,75	0,80	0,85	0,90	0,95	1

a) The anchor spacing shall not be smaller than the minimum anchor spacing s_{min} given in the table with the setting details. This influencing factor must be considered for every anchor spacing.

Influence of base material thickness

h/h_{ef}	2,0	2,2	2,4	2,6	2,8	3,0	3,2	3,4	3,6	$\geq 3,68$
$f_{h,sp} = [h/(2 \cdot h_{ef})]^{2/3}$	1	1,07	1,13	1,19	1,25	1,31	1,37	1,42	1,48	1,5

Influence of reinforcement

Anchor size	M6x25	M8x25	M10x25	M12x25	M6x30	M8x30	M8x40	M10x30	M10x40	M12x50	M16x65	M20x80
$f_{re,N} = 0,5 + h_{ef}/200\text{mm} \leq 1$	0,63 ^{a)}	0,63 ^{a)}	0,63 ^{a)}	0,63 ^{a)}	0,65 ^{a)}	0,65 ^{a)}	0,7 ^{a)}	0,65 ^{a)}	0,7 ^{a)}	0,75 ^{a)}	0,83 ^{a)}	0,9 ^{a)}

a) This factor applies only for dense reinforcement. If in the area of anchorage there is reinforcement with a spacing ≥ 150 mm (any diameter) or with a diameter ≤ 10 mm and a spacing ≥ 100 mm, then a factor $f_{re,N} = 1$ may be applied.

Shear loading

The design shear resistance is the lower value of

- Steel resistance: $V_{Rd,s}$
- Concrete pryout resistance: $V_{Rd,cp} = k \cdot N_{Rd,c}$
- Concrete edge resistance: $V_{Rd,c} = V_{Rd,c}^0 \cdot f_B \cdot f_{\beta} \cdot f_h \cdot f_4 \cdot f_{hef} \cdot f_c$

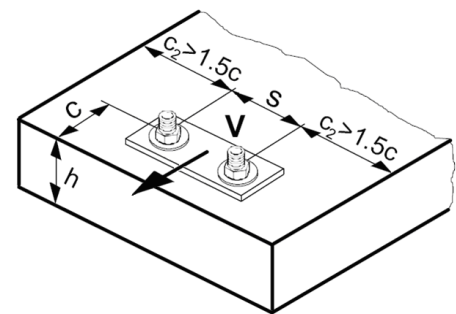

Basic design shear resistance

Design steel resistance $V_{Rd,s}$ for HKD / HKD-E/S Steel Strength 5.8 and for HKD-ER/SR A4-70

Anchor size			Hilti technical data				according ETA-02/0032, issue 2012-10-18							
			M6x25	M8x25	M10x25	M12x25	M6x30	M8x30	M8x40	M10x30	M10x40	M12x50	M16x65	M20x80
$V_{Rd,s}$	HKD	[kN]	4,0	6,2	7,5	14,1	-	6,9	7,3	8,0	8,8	14,6	27,0	39,6
	HKD-S, HKD-E	[kN]	3,9	-	-	-	3,9	5,5	5,5	5,9	6,4	11,3	17,5	27,8
	HKD-SR, HKD-ER	[kN]	4,1	-	-	-	4,2	5,5	-	-	6,9	12,3	21,1	33,6

Design concrete pryout resistance $V_{Rd,cp} = k \cdot N_{Rd,c}$ ^{a)}

Anchor size	Hilti technical data				according ETA-02/0032, issue 2012-10-18							
	M6x25	M8x25	M10x25	M12x25	M6x30	M8x30	M8x40	M10x30	M10x40	M12x50	M16x65	M20x80
k	1				2							

a) $N_{Rd,c}$: Design concrete cone resistance

Design concrete edge resistance^{a)} $V_{Rd,c} = V_{Rd,c}^0 \cdot f_B \cdot f_{\beta} \cdot f_h \cdot f_4 \cdot f_{hef} \cdot f_c$

Anchor size	M6x25	M8x25	M10x25	M12x25	M6x30	M8x30	M8x40	M10x30	M10x40	M12x50	M16x65	M20x80
$V_{Rd,c}^0$ [kN]	5,8	8,4	11,3	16,4	5,9	8,5	8,5	11,4	11,5	16,8	27,1	39,2

a) For anchor groups only the anchors close to the edge must be considered

Influencing factors

Influence of concrete strength

Concrete strength designation (ENV 206)	C 20/25	C 25/30	C 30/37	C 35/45	C 40/50	C 45/55	C 50/60
$f_B = (f_{ck,cube}/25N/mm^2)^{1/2}$ ^{a)}	1	1,1	1,22	1,34	1,41	1,48	1,55

a) $f_{ck,cube}$ = concrete compressive strength, measured on cubes with 150 mm side length

Influence of angle between load applied and the direction perpendicular to the free edge

Angle β	0°	10°	20°	30°	40°	50°	60°	70°	80°	≥ 90°
$f_{\beta} = \sqrt{\frac{1}{(\cos \alpha_V)^2 + \left(\frac{\sin \alpha_V}{2,5}\right)^2}}$	1	1,01	1,05	1,13	1,24	1,40	1,64	1,97	2,32	2,50

Influence of base material thickness

h/c	0,15	0,3	0,45	0,6	0,75	0,9	1,05	1,2	1,35	≥ 1,5
$f_h = \{h/(1,5 \cdot c)\}^{1/2} \leq 1$	0,32	0,45	0,55	0,63	0,71	0,77	0,84	0,89	0,95	1,00

Influence of anchor spacing and edge distance ^{a)} for concrete edge resistance: f_4
 $f_4 = (c/h_{ef})^{1,5} \cdot (1 + s / [3 \cdot c]) \cdot 0,5$

c/h _{ef}	Single anchor	Group of two anchors s/h _{ef}														
		0.75	1.50	2.25	3.00	3.75	4.50	5.25	6.00	6.75	7.50	8.25	9.00	9.75	10.50	11.25
0,50	0,35	0,27	0,35	0,35	0,35	0,35	0,35	0,35	0,35	0,35	0,35	0,35	0,35	0,35	0,35	0,35
0,75	0,65	0,43	0,54	0,65	0,65	0,65	0,65	0,65	0,65	0,65	0,65	0,65	0,65	0,65	0,65	0,65
1,00	1,00	0,63	0,75	0,88	1,00	1,00	1,00	1,00	1,00	1,00	1,00	1,00	1,00	1,00	1,00	1,00
1,25	1,40	0,84	0,98	1,12	1,26	1,40	1,40	1,40	1,40	1,40	1,40	1,40	1,40	1,40	1,40	1,40
1,50	1,84	1,07	1,22	1,38	1,53	1,68	1,84	1,84	1,84	1,84	1,84	1,84	1,84	1,84	1,84	1,84
1,75	2,32	1,32	1,49	1,65	1,82	1,98	2,15	2,32	2,32	2,32	2,32	2,32	2,32	2,32	2,32	2,32
2,00	2,83	1,59	1,77	1,94	2,12	2,30	2,47	2,65	2,83	2,83	2,83	2,83	2,83	2,83	2,83	2,83
2,25	3,38	1,88	2,06	2,25	2,44	2,63	2,81	3,00	3,19	3,38	3,38	3,38	3,38	3,38	3,38	3,38
2,50	3,95	2,17	2,37	2,57	2,77	2,96	3,16	3,36	3,56	3,76	3,95	3,95	3,95	3,95	3,95	3,95
2,75	4,56	2,49	2,69	2,90	3,11	3,32	3,52	3,73	3,94	4,15	4,35	4,56	4,56	4,56	4,56	4,56
3,00	5,20	2,81	3,03	3,25	3,46	3,68	3,90	4,11	4,33	4,55	4,76	4,98	5,20	5,20	5,20	5,20
3,25	5,86	3,15	3,38	3,61	3,83	4,06	4,28	4,51	4,73	4,96	5,18	5,41	5,63	5,86	5,86	5,86
3,50	6,55	3,51	3,74	3,98	4,21	4,44	4,68	4,91	5,14	5,38	5,61	5,85	6,08	6,31	6,55	6,55
3,75	7,26	3,87	4,12	4,36	4,60	4,84	5,08	5,33	5,57	5,81	6,05	6,29	6,54	6,78	7,02	7,26
4,00	8,00	4,25	4,50	4,75	5,00	5,25	5,50	5,75	6,00	6,25	6,50	6,75	7,00	7,25	7,50	7,75
4,25	8,76	4,64	4,90	5,15	5,41	5,67	5,93	6,18	6,44	6,70	6,96	7,22	7,47	7,73	7,99	8,25
4,50	9,55	5,04	5,30	5,57	5,83	6,10	6,36	6,63	6,89	7,16	7,42	7,69	7,95	8,22	8,49	8,75
4,75	10,35	5,45	5,72	5,99	6,27	6,54	6,81	7,08	7,36	7,63	7,90	8,17	8,45	8,72	8,99	9,26
5,00	11,18	5,87	6,15	6,43	6,71	6,99	7,27	7,55	7,83	8,11	8,39	8,66	8,94	9,22	9,50	9,78
5,25	12,03	6,30	6,59	6,87	7,16	7,45	7,73	8,02	8,31	8,59	8,88	9,17	9,45	9,74	10,02	10,31
5,50	12,90	6,74	7,04	7,33	7,62	7,92	8,21	8,50	8,79	9,09	9,38	9,67	9,97	10,26	10,55	10,85

a) The anchor spacing and the edge distance shall not be smaller than the minimum anchor spacing s_{min} and the minimum edge distance c_{min} .

Influence of embedment depth

Anchor size	M6x25	M8x25	M10x25	M12x25	M6x30	M8x30	M8x40	M10x30	M10x40	M12x50	M16x65	M20x80
$f_{hef} = 0,05 \cdot (h_{ef} / d)^{1,68}$	0,34	0,23	0,17	0,12	0,46	0,32	0,51	0,23	0,38	0,38	0,36	0,35

Influence of edge distance ^{a)}

c/d	4	6	8	10	15	20	30	40
$f_c = (d / c)^{0,19}$	0,77	0,71	0,67	0,65	0,60	0,57	0,52	0,50

a) The edge distance shall not be smaller than the minimum edge distance c_{min} .

Combined tension and shear loading

For combined tension and shear loading see section "Anchor Design".

Precalculated values

Design resistance calculated according ETAG 001, Annex C and data given in ETA-02/0032, issue 2012-10-18. All data applies to concrete C 20/25 – $f_{ck,cube} = 25$ N/mm² and steel strength 5.8 and/or A4-70.

Recommended loads can be calculated by dividing the design resistance by an overall partial safety factor for action $\gamma = 1,4$. The partial safety factors for action depend on the type of loading and shall be taken from national regulations.

Design resistance

Single anchor, no edge effects

		Non-cracked concrete												
		Hilti technical data				according ETA-02/0032, issue 2012-10-18								
Anchor size		M6x25	M8x25	M10x25	M12x25	M6x30	M8x30	M8x40	M10x30	M10x40	M12x50	M16x65	M20x80	
Min. base material thickness h_{min}	[mm]	100	100	100	100	100	100	100	100	100	100	130	160	
	Tensile N_{Rd}													
	HKD	[kN]	4,2	4,2	4,2	4,2	-	5,5	8,5	5,5	8,5	11,9	17,6	24,0
	HKD-S HKD-E	[kN]	3,0	-	-	-	4,6	4,6	5,0	4,6	7,1	9,9	17,6	24,0
	HKD-SR HKD-ER	[kN]	3,0	-	-	-	4,6	4,6	-	-	7,1	9,9	17,6	24,0
	Shear V_{Rd}, without lever arm													
	HKD	[kN]	4,0	4,2	4,2	4,2	-	6,9	7,4	8,0	8,8	14,6	27,0	39,6
	HKD-S HKD-E	[kN]	3,9	-	-	-	3,9	5,5	5,6	5,8	6,4	11,3	17,5	27,8
	HKD-SR HKD-ER	[kN]	4,1	-	-	-	4,2	5,5	-	-	6,9	12,3	21,1	33,6



Single anchor, min. edge distance ($c = c_{min}$)

		Non-cracked concrete												
		Hilti technical data				according ETA-02/0032, issue 2012-10-18								
Anchor size		M6x25	M8x25	M10x25	M12x25	M6x30	M8x30	M8x40	M10x30	M10x40	M12x50	M16x65	M20x80	
Min. base material thickness h_{min}	[mm]	100	100	100	100	100	100	100	100	100	100	130	160	
Min. edge distance c_{min}	[mm]	100	100	100	100	105	105	140	105	140	175	230	280	
	Tensile N_{Rd}													
	HKD	[kN]	4,2	4,2	4,2	4,2	-	5,5	8,5	5,5	8,5	11,9	17,6	24,0
	HKD-S HKD-E	[kN]	3,0	-	-	-	4,6	4,6	7,1	4,6	7,1	9,9	17,6	24,0
	HKD-SR HKD-ER	[kN]	3,0	-	-	-	4,6	4,6	-	-	7,1	9,9	17,6	24,0
	Shear V_{Rd}, without lever arm													
	HKD	[kN]	4,0	4,2	4,2	4,2	-	6,9	7,4	8,0	8,8	14,6	26,0	36,0
	HKD-S HKD-E	[kN]	3,9	-	-	-	4,0	5,5	5,6	5,8	6,4	11,3	17,5	27,8
	HKD-SR HKD-ER	[kN]	4,1	-	-	-	4,2	5,5	-	-	6,9	12,3	21,1	33,6

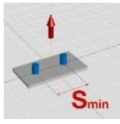
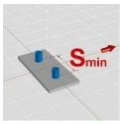
Double anchor, no edge effects, min. spacing ($s = s_{min}$),
(load values are valid for one anchor)

		Non-cracked concrete												
		Hilti technical data				according ETA-02/0032, issue 2012-10-18								
Anchor size		M6x25	M8x25	M10x25	M12x25	M6x30	M8x30	M8x40	M10x30	M10x40	M12x50	M16x65	M20x80	
Min. base material thickness h_{min}	[mm]	100	100	100	100	100	100	100	100	100	100	130	160	
Min. spacing s_{min}	[mm]	80	80	80	80	60	60	80	60	80	125	130	160	
	Tensile N_{Rd}													
	HKD	[kN]	2,9	2,9	2,9	2,9	-	3,5	5,5	3,5	5,5	8,1	11,3	15,5
	HKD-S HKD-E	[kN]	2,0	-	-	-	3,0	3,0	4,6	3,0	4,6	6,7	11,3	15,5
	HKD-SR HKD-ER	[kN]	2,0	-	-	-	3,0	3,0	-	-	4,6	6,7	11,3	15,5
	Shear V_{Rd}, without lever arm													
	HKD	[kN]	4,0	4,2	4,2	4,2	-	6,9	7,4	8,0	8,8	14,6	27,0	39,6
	HKD-S HKD-E	[kN]	3,8	-	-	-	3,9	5,5	5,6	5,8	6,4	11,3	17,5	27,8
	HKD-SR HKD-ER	[kN]	3,8	-	-	-	4,2	5,5	-	-	6,9	12,3	21,1	33,6

HKD Push-in anchor, Redundant fastening

	Anchor version	Benefits
	HKD Carbon steel with lip	<ul style="list-style-type: none"> - simple and well proven - approved, tested and confirmed by everyday jobsite experience - reliable setting thanks to simple visual check - versatile - for medium-duty fastening with bolts or threaded rods - available in various materials and sizes for maximized coverage of possible applications
	HKD-S(R) Carbon steel, stainless steel with lip	
	HKD-E(R) Carbon steel, stainless steel without lip	



Concrete



Tensile zone

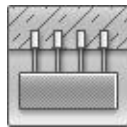

Redundant fastening



Fire resistance

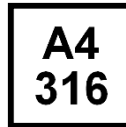

Corrosion resistance



Sprinkler approved



European Technical Approval



CE conformity

a) Redundant fastening only

Approvals / certificates

Description	Authority / Laboratory	No. / date of issue
European technical approval ^{a)}	DIBt, Berlin	ETA-06/0047 / 2012-23-28
Fire test report	DIBt, Berlin	ETA-06/0047 / 2012-23-28
Assessment report (fire)	warringtonfire	WF 327804/A / 2013-07-10

a) All data given in this section for HKD-S(R) and HKD-E(R), according ETA-06/0047, issue 2012-09-28 . The anchor is to be used only for redundant fastening for non-structural applications.

Basic loading data for all load directions according design method B of ETAG 001

All data in this section applies to

- Correct setting (See setting instruction)
- No edge distance and spacing influence
- Concrete C 20/25 $f_{ck,cube} = 25 \text{ N/mm}^2$ to C50/60, $f_{ck,cube} = 60 \text{ N/mm}^2$
- Minimum base material thickness
- Anchors in redundant fastening

Characteristic Resistance, all load directions

Anchor size		M6x25	M6x30	M8x25	M8x30	M8x40	M10x25	M10x30	M10x40	M12x25	M12x50	M16x65
Load F_{Rk}												
HKD	kN	2,0	-	3,0	5,0	5,0	4,0	5,0	7,5	4,0	9,0	16,0
HKD-S, HKD-E	kN	-	3,0	-	3,0	5,0	-	4,0	6,0	-	6,0	-
HKD-SR, HKD-ER	kN	-	3,0	-	3,0	-	-	-	6,0	-	6,0	-

Design Resistance, all load directions

Anchor size		M6x25	M6x30	M8x25	M8x30	M8x40	M10x25	M10x30	M10x40	M12x25	M12x50	M16x65
Load F_{Rd}												
HKD	kN	1,3	-	2,0	2,8	3,3	2,2	3,3	5,0	2,7	6,0	10,7
HKD-S, HKD-E	kN	-	2,0	-	2,0	3,3	-	2,7	4,0	-	4,0	-
HKD-SR, HKD-ER	kN	-	2,0	-	2,0	-	-	-	4,0	-	4,0	-

Recommended loads ^{a)}, all load directions

Anchor size		M6x25	M6x30	M8x25	M8x30	M8x40	M10x25	M10x30	M10x40	M12x25	M12x50	M16x65
Load F_{rec}												
HKD	kN	1,0	-	1,4	2,0	2,4	1,6	2,4	3,6	1,9	4,3	7,6
HKD-S, HKD-E	kN	-	1,4	-	1,4	2,4	-	1,9	2,9	-	2,9	-
HKD-SR, HKD-ER	kN	-	1,4	-	1,4	-	-	-	2,9	-	2,9	-

a) With overall partial safety factor for action $\gamma = 1,4$. The partial safety factors for action depend on the type of loading and shall be taken from national regulations.

Requirements for redundant fastening

The definition of redundant fastening according to Member States is given in the ETAG 001 Part six, Annex 1. In absence of a definition by a Member State the following default values may be taken

Minimum number of fixing points	Minimum number of anchors per fixing point	Maximum design load of action N_{Sd} per fixing point ^{a)}
3	1	2 kN
4	1	3 kN

a) The value for maximum design load of actions per fastening point N_{Sd} is valid in general that means all fastening points are considered in the design of the redundant structural system. The value N_{Sd} may be increased if the failure of one (= most unfavourable) fixing point is taken into account in the design (serviceability and ultimate limit state) of the structural system e.g. suspended ceiling.

Materials

Mechanical properties of HKD, HKD-S, HKS-E, HKD-SR and HKD-ER

Anchor size			M6	M8	M10	M12	M16
Nominal tensile strength f_{uk}	HKD	[N/mm ²]	570	570	570	570	640
	HKD-S HKD-E	[N/mm ²]	560	560	510	510	-
	HKD-SR HKD-ER	[N/mm ²]	540	540	540	540	-
Yield strength f_{yk}	HKD	[N/mm ²]	460	460	460	480	510
	HKD-S HKD-E	[N/mm ²]	440	440	410	410	-
	HKD-SR HKD-ER	[N/mm ²]	355	355	355	355	-
Stressed cross-section A_s	HKD	[mm ²]	20,7	26,7	32,7	60,1	105
	HKD-S (R) HKD-E (R)	[mm ²]	20,9	26,1	28,8	58,7	-
Moment of resistance W	HKD	[mm ³]	32,3	54,6	82,9	184	431
	HKD-S (R) HKD-E (R)	[mm ³]	50	79	110	264	-
Char. bending resistance for rod or bolt $M_{Rk,s}^0$	With 5.8 Gr. Steel	[Nm]	7,6	18,7	37,4	65,5	167
	HKD-SR HKD-ER with A4-70	[Nm]	11	26	52	92	-

Material quality

Part	Material	
Anchor Body	HKD	Steel Fe/Zn5 galvanised to min. 5 µm
	HKD-S HKD-E	Steel Fe/Zn5 galvanised to min. 5 µm
	HKD-SR HKD-ER	Stainless steel, 1.4401, 1.4404, 1.4571
Tapered expansion plug	HKD	Steel material
	HKD-S HKD-E	Steel material
	HKD-SR HKD-ER	Stainless steel, 1.4401, 1.4404, 1.4571

Anchor dimensions

Anchor size Anchor version			M6x25	M6x30	M8x25	M8x30	M8x40	M10x25	M10x30	M10x40	M12x25	M12x50	M16x65
Effective anchorage depth	h_{ef}	[mm]	25	30	25	30	40	25	30	40	25	50	65
Anchor diameter	d_1	[mm]	7,9	8	9,95	9,95	9,95	11,9	11,8	11,95	14,9	14,9	19,75
Plug diameter	d_2	[mm]	5,1	5	6,35	6,5	6,35	8,1	8,2	8,2	9,7	10,3	13,8
Plug length	l_1	[mm]	10	15	7	12	16	7	12	16	7,2	20	29

Anchor body

HKD

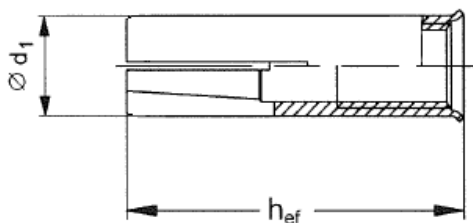

HKD-S and HKD-SR

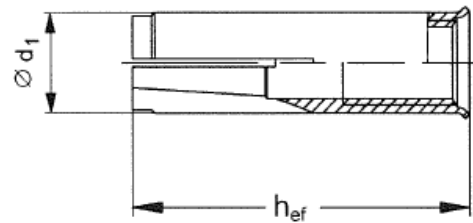

HKD-E and HKD ER

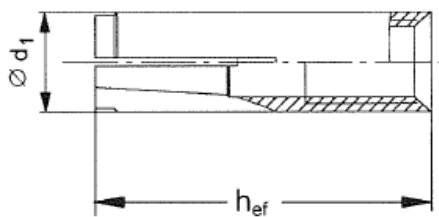

Expansions plugs

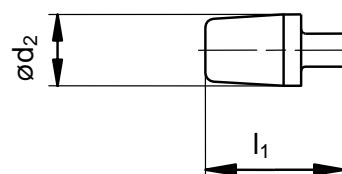
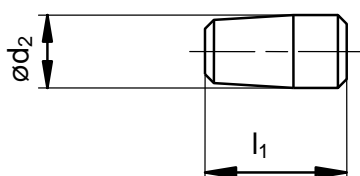

Setting

Installation equipment

Anchor size	M6x25	M6x30	M8x25	M8x30	M8x40	M10x25	M10x30	M10x40	M12x25	M12x50	M16x65
Rotary hammer	TE 2 – TE 16									TE 16 – 50	
Machine setting tool HSD-M	6x25/30		8x25/30		8x40	10x25/30		10x40	12x25	12x50	16x65
Hand Setting tool HSD-G											
Other tools	hammer, torque wrench, blow out pump										

Setting instruction

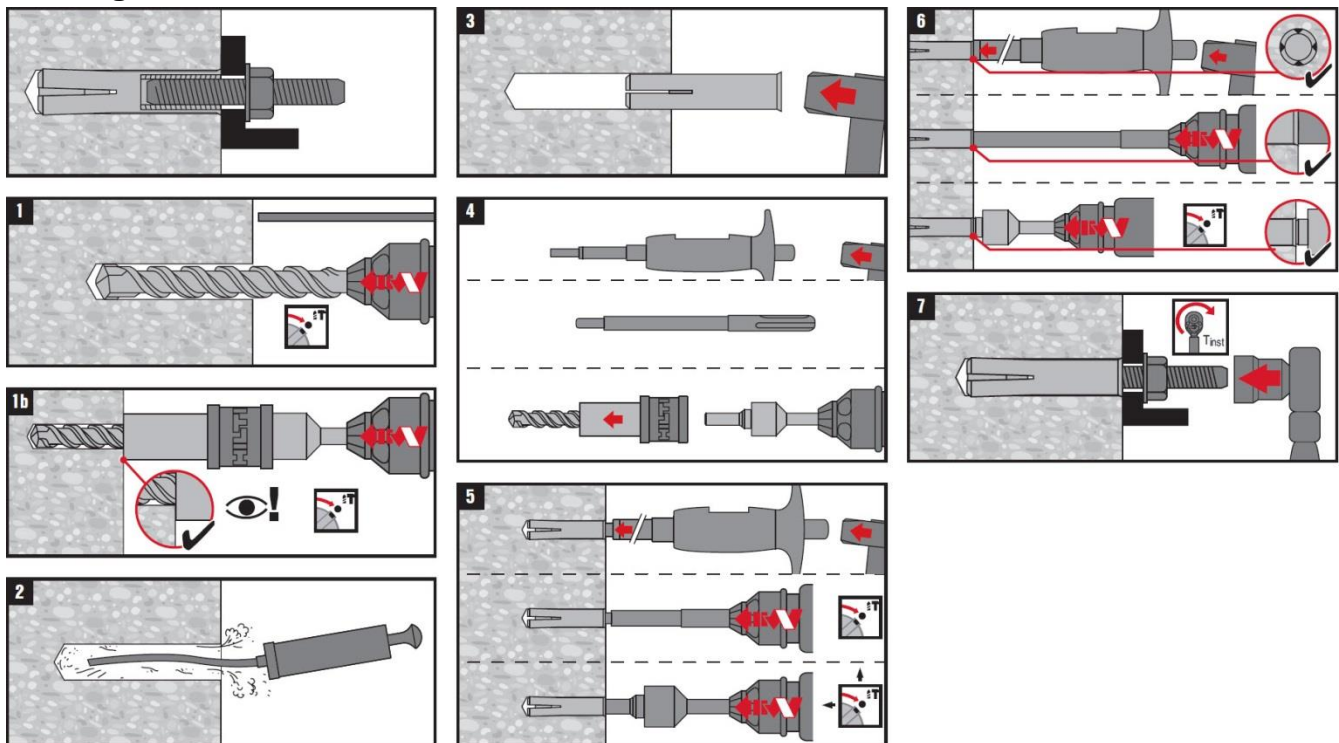

For detailed information on installation see instruction for use given with the package of the product.

Setting details: depth of drill hole h_1 and effective anchorage depth h_{ef}

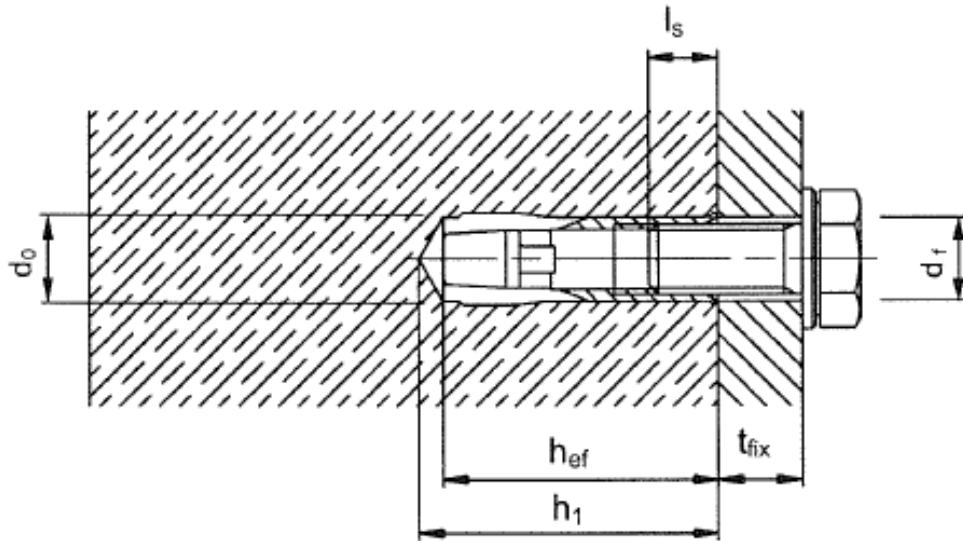

Setting details

Anchor size		M6x25	M6x30	M8x25	M8x30	M8x40	M10x25	M10x30	M10x40	M12x25	M12x50	M16x65
Nominal diameter of drill bit	d_0 [mm]	8	8	10	10	10	12	12	12	15	15	20
Cutting diameter of drill bit	$d_{cut} \leq$ [mm]	8,45	8,45	10,5	10,5	10,5	12,5	12,5	12,5	15,5	15,5	20,5
Depth of drill hole	$h_1 \geq$ [mm]	27	32	27	33	43	27	33	43	27	54	70
Screwing depth	$l_{s,min}$ [mm]	6	6	8	8	8	10	10	10	12	12	16
	$l_{s,max}$ [mm]	12	12,5	11,5	14,5	17,5	12	13	18	12	22	30,5
Diameter of clearance hole in the fixture	$d_f \leq$ [mm]	7	7	9	9	9	12	12	12	14	14	18
Effective anchorage depth	h_{ef} [mm]	25	30	25	30	40	25	30	40	25	50	65
Max. torque moment	T_{inst} [Nm]	4	4	8	8	8	15	15	15	35	35	60

base material thickness, anchor spacing and edge distances

Anchor size		M6x25 M8x25 M10x25 M12x25	M6x30 M8x30 M10x30	M8x40 M10x40	M12x50	M16x65
Minimum base material thickness	h_{min} [mm]	80	80	80	-	-
Minimum spacing and Minimum edge distance HKD HKD-S (R) HKD-E (R)	s_{min} [mm]	200	200	200	-	-
	c_{min} [mm]	150	150	150	-	-
Minimum base material thickness	h_{min} [mm]	100	100	100	100	130
Minimum spacing and minimum edge distance HKD-S (R) HKD-E (R)	s_{min} [mm]	80	60	80	125	130
	c_{min} [mm]	140	105	140	175	230
Minimum spacing HKD	s_{min} [mm]	80	60	80	125	130
	for $c \geq$ [mm]	140	105	140	175	230
Minimum edge distance HKD	c_{min} [mm]	100	80	140	175	230
	for $s \geq$ [mm]	150	120	80	125	130

For spacing (edge distance) smaller than critical spacing (critical edge distance) the design loads have to be reduced.

HKV Push-in anchor, Single anchor application

Anchor version	Benefits
 <p>HKV Carbon steel without lip</p>	<ul style="list-style-type: none"> - simple and well proven - approved, tested and confirmed by everyday jobsite experience - reliable setting thanks to simple visual check - versatile - for medium-duty fastening with bolts or threaded rods - available in various materials and sizes for maximized coverage of possible applications



Concrete

Basic loading data (for a single anchor)

All data in this section applies to

- Correct setting (See setting instruction)
- No edge distance and spacing influence
- Concrete as specified in the table
- Minimum base material thickness
- Concrete C 20/25, $f_{ck,cube} = 25 \text{ N/mm}^2$
- screw or rod with steel strength 5.8 (carbon steel) and/or A4-70 (stainless steel)

Mean Ultimate Resistance

Anchor size	M6x25	M8x30	M10x30	M10x40	M12x50	M16x65
Tensile $N_{Ru,m}$ [kN]	5,6	7,8	7,8	12,1	16,9	35,3
Shear $V_{Ru,m}$ [kN]	5,5	9,4	11,0	12,2	20,1	37,1

Characteristic Resistance

Anchor size	M6x25	M8x30	M10x30	M10x40	M12x50	M16x65
Tensile N_{Rk} [kN]	4,2	5,9	5,9	9,1	12,7	26,5
Shear V_{Rk} [kN]	5,0	8,6	10,0	11,0	18,3	33,8

Design Resistance

Anchor size	M6x25	M8x30	M10x30	M10x40	M12x50	M16x65
Tensile N_{Rd} [kN]	2,8	3,9	3,9	6,1	8,5	17,6
Shear V_{Rd} [kN]	4,0	6,9	8,0	8,8	14,6	27,0

Recommended loads ^{a)}

Anchor size	M6x25	M8x30	M10x30	M10x40	M12x50	M16x65
Tensile N_{rec} [kN]	2,0	2,8	2,8	4,3	6,0	12,6
Shear V_{rec} [kN]	2,9	4,9	5,7	6,3	10,5	19,3

b) With overall partial safety factor for action $\gamma = 1,4$. The partial safety factors for action depend on the type of loading and shall be taken from national regulations.

Materials

Mechanical properties of HKV

Anchor size	M6x25	M8x30	M10x30	M10x40	M12x50	M16x65
Nominal tensile strength f_{uk} [N/mm ²]	570	570	570	570	570	640
Yield strength f_{yk} [N/mm ²]	460	460	460	460	460	510
Stressed cross-section A_s [mm ²]	20,7	26,7	32,7	32,7	60,1	105
Moment of resistance W [mm ³]	32,3	54,6	82,9	82,9	184	431
Char. bending resistance for rod or bolt $M^0_{Rk,s}$ with 5.8 Steel Strength [Nm]	7,6	18,7	37,4	37,4	65,5	167

Material quality

Part	Material
Anchor Body	Steel Fe/Zn5 galvanised to min. 5 μ m
expansion plug	Steel material

Anchor dimensions

Anchor size	M6x25	M8x30	M10x30	M10x40	M12x50	M16x65
Effective anchorage depth h_{ef} [mm]	25	30	30	40	50	65
Anchor diameter d_1 [mm]	7,9	9,95	11,8	11,95	14,9	19,75
Plug diameter d_2 [mm]	5,1	6,5	8,2	8,2	10,3	13,8
Plug length l_1 [mm]	10	12	12	16	20	29

Anchor body

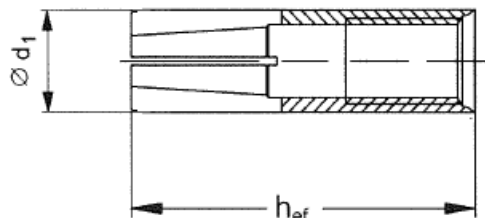

Expansions plugs

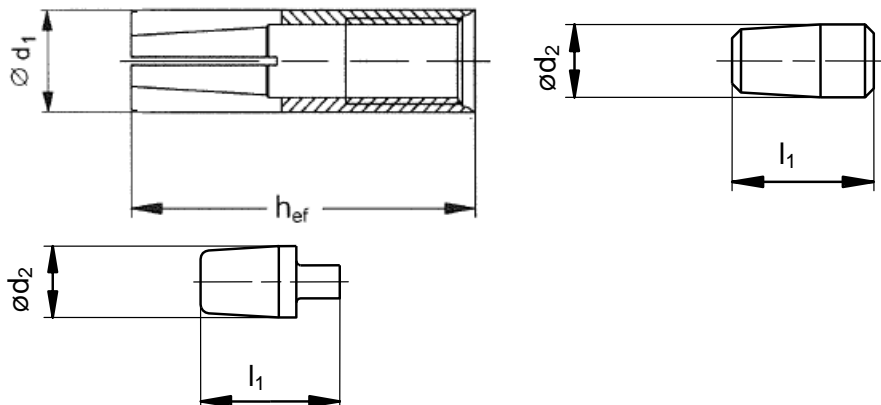

Setting

Installation equipment

Anchor size	M6x25	M8x30	M10x30	M10x40	M12x50	M16x65
Rotary hammer	TE 2 – TE 16				TE 16 – TE 50	
Machine setting tool	HSD-M	6x25/30	8x25/30	10x25/30	10x40	12x50
Hand Setting tool	HSD-G					16x65
Other tools	hammer, torque wrench, blow out pump					

Setting instruction

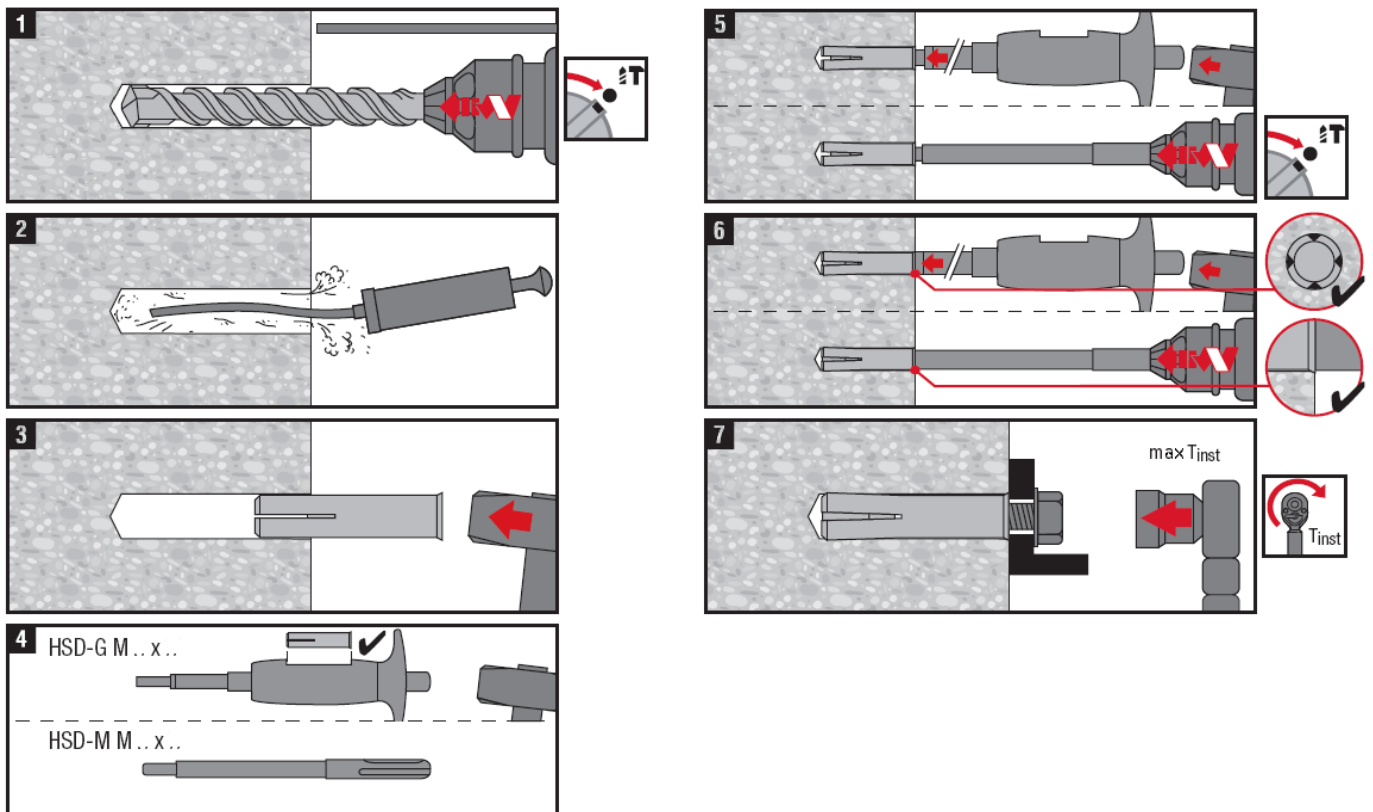

For detailed information on installation see instruction for use given with the package of the product.

For technical data for anchors in diamond drilled holes please contact the Hilti Technical advisory service.

Setting details: depth of drill hole h_1 and effective anchorage depth h_{ef}

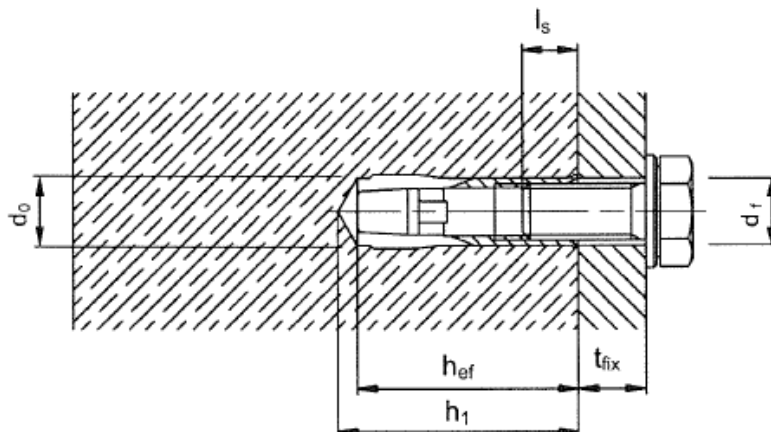

Setting details

Anchor size		M6x25	M8x30	M10x30	M10x40	M12x50	M16x65
Nominal diameter of drill bit	d_o [mm]	8	10	12	12	15	20
Cutting diameter of drill bit	$d_{cut} \leq$ [mm]	8,45	10,5	13	12,5	15,5	20,5
Depth of drill hole	$h_1 \geq$ [mm]	27	33	33	43	54	70
Screwing depth	$l_{s,min}$ [mm]	6	8	10	10	12	16
	$l_{s,max}$ [mm]	12	14,5	13	18	22	30,5
Diameter of clearance hole in the fixture	$d_f \leq$ [mm]	7	9	12	12	14	18
Effective anchorage depth	h_{ef} [mm]	25	30	30	40	50	65
Max. torque moment	T_{inst} [Nm]	4	8	15	15	35	60

Base material thickness, anchor spacing and edge distances

Anchor size		M6x25	M8x30	M10x30	M10x40	M12x50	M16x65
Minimum base material thickness	h_{min} [mm]	100	100	100	100	100	130
Minimum spacing and minimum edge distance	s_{min} [mm]	80	60	60	80	125	130
	c_{min} [mm]	140	105	105	140	175	230

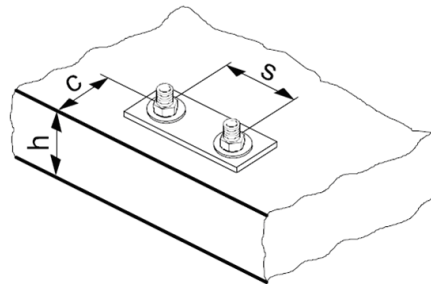

HUD-1 Universal anchor

	Anchor version	Benefits
	HUD-1	<ul style="list-style-type: none"> - fast setting - flexibility of screw length - an anchor for every base material



Concrete

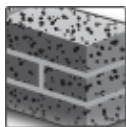

Solid brick



Hollow brick

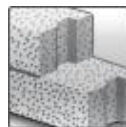

Autoclaved
aerated
concrete



Drywall

Basic loading data (for a single anchor)

All data in this section applies to

- Correct setting (See setting instruction)
- Load data are only valid for the specified woodscrew type
- No edge distance and spacing influence
- Base material as specified in the table
- Minimum base material thickness

Characteristic resistance

Anchor size	Screw type ^{d)}	5x25		6x30		8x40		10x50		12x60	14x70
		W Size 4 DIN 96	C Size 4	W Size 5 DIN 96	C Size 5	W Size 6 DIN 96	C Size 6	W Size 8 DIN 96	C Size 8	W Size 10 DIN 571	W Size 12 DIN 571
Concrete ≥ C16/20	N _{Rk} [kN]	1,5	0,5	2,75	1,75	4,25	2,5	7	-	10	15
	V _{Rk} [kN]	2	-	4,5	-	6,25	-	11	-	15	28
Solid clay brick Mz 20	N _{Rk} [kN]	0,85	0,3	1,75	0,75	3	1,75	4	-	5	5 ^{a)}
	V _{Rk} [kN]	1,2	-	1,5	-	2,2	-	-	-	-	-
Solid sand-lime brick KS 12	N _{Rk} [kN]	1,25	0,75	2,5	1,5	4,25	2	5	-	7,5	7,5 ^{a)}
	V _{Rk} [kN]	1,25	-	2,8	-	3,7	-	6,6	-	-	-
Hollow clay brick HlzB 12	N _{Rk} [kN]	0,4	0,25	0,5	0,4	1	0,6	1,25	-	1,4	1,6
	V _{Rk} [kN]	1,15	-	1,75	-	-	-	-	-	-	-
Hollow clay brick HlzB 12 – 15mm plastered	N _{Rk} [kN]	0,4	0,25	0,75	0,5	1,25	0,75	1,5	-	1,75	2
	V _{Rk} [kN]	1,15	-	1,75	-	-	-	-	-	-	-
Autoclaved aerated concrete AAC 2	N _{Rk} [kN]	0,3	0,2	0,5	0,3	0,75	0,5	1	-	1,25	1,5
	V _{Rk} [kN]	0,2	-	0,25	-	0,4	-	-	-	-	-
Autoclaved aerated concrete AAC 4	N _{Rk} [kN]	0,5	0,3	0,75	0,5	1,5	1	2	-	2,5	3
	V _{Rk} [kN]	0,65	-	0,9	-	1,5	-	-	-	-	-
Gypsum board Thickness 12,5mm	N _{Rk} [kN]	0,2	0,3	0,25	0,4	0,3	0,5	-	0,75 ^{b)}	-	-
	V _{Rk} [kN]	0,45	-	0,7	-	-	-	-	-	-	-
Gypsum board Thickness 2x12,5mm	N _{Rk} [kN]	0,3	0,3	0,4	0,4	0,5	0,5	0,75 ^{b)}	1 ^{b)}	1,5 ^{c)}	-
	V _{Rk} [kN]	0,45	-	0,7	-	-	-	-	-	-	-
Fibre reinforced gypsum board Thickness 12,5mm	N _{Rk} [kN]	0,45	-	0,6	-	0,9	-	-	-	-	-
	V _{Rk} [kN]	0,72	-	0,96	-	1,44	-	-	-	-	-
Fibre reinforced gypsum board Thickness 2x12,5mm	N _{Rk} [kN]	0,45	-	1,2	-	1,8	-	2,1	-	-	-
	V _{Rk} [kN]	0,72	-	1,92	-	2,88	-	3,36	-	-	-

a) only with screw diameter 6mm

b) only with screw diameter 8mm

c) only with screw diameter 10mm

d) Screw type: W: Wood-screw C: Chipboard screw

Load data are valid for the mentioned woodscrew type, if other types or different screws are used the load capacity may decrease.

Design resistance

Anchor size	Screw type ^{d)}	5x25		6x30		8x40		10x50		12x60	14x70
		W Size 4 DIN 96	C Size 4	W Size 5 DIN 96	C Size 5	W Size 6 DIN 96	C Size 6	W Size 8 DIN 96	C Size 8	W Size 10 DIN 571	W Size 12 DIN 571
Concrete ≥ C16/20	N _{Rd} [kN]	0,42	0,14	0,77	0,49	1,19	0,70	1,96		2,80	4,20
	V _{Rd} [kN]	0,56		1,26		1,75		3,08		4,20	7,84
Solid clay brick Mz 20	N _{Rd} [kN]	0,24	0,08	0,49	0,21	0,84	0,49	1,12		1,40	1,40 ^{c)}
	V _{Rd} [kN]	0,34		0,42		0,62					
Solid sand-lime brick KS 12	N _{Rd} [kN]	0,35	0,21	0,70	0,42	1,19	0,56	1,40		2,10	2,10 ^{c)}
	V _{Rd} [kN]	0,35		0,78		1,04		1,85			
Hollow clay brick HlzB 12	N _{Rd} [kN]	0,11	0,07	0,14	0,11	0,28	0,17	0,35		0,39	0,45
	V _{Rd} [kN]	0,32		0,49							
Hollow clay brick HlzB 12 – 15mm plastered	N _{Rd} [kN]	0,11	0,07	0,21	0,14	0,35	0,21	0,42		0,49	0,56
	V _{Rd} [kN]	0,32		0,49							
Autoclaved aerated concrete AAC 2	N _{Rd} [kN]	0,08	0,06	0,14	0,08	0,21	0,14	0,28		0,35	0,42
	V _{Rd} [kN]	0,06		0,07		0,11					
Autoclaved aerated concrete AAC 4	N _{Rd} [kN]	0,14	0,08	0,21	0,14	0,42	0,28	0,56		0,70	0,84
	V _{Rd} [kN]	0,18		0,25		0,42					
Gypsum board Thickness 12,5mm	N _{Rd} [kN]	0,06	0,08	0,07	0,11	0,08	0,14		0,21 ^{a)}		
	V _{Rd} [kN]	0,13		0,20							
Gypsum board Thickness 2x12,5mm	N _{Rd} [kN]	0,08	0,08	0,11	0,11	0,14	0,14	0,21 ^{a)}	0,28 ^{a)}	0,42 ^{b)}	
	V _{Rd} [kN]	0,13		0,20							
Fibre reinforced gypsum board Thickness 12,5mm	N _{Rd} [kN]	0,13		0,17		0,25					
	V _{Rd} [kN]	0,20		0,27		0,40					
Fibre reinforced gypsum board Thickness 2x12,5mm	N _{Rd} [kN]	0,13		0,34		0,50		0,59			
	V _{Rd} [kN]	0,20		0,54		0,81		0,94			

a) only with screw diameter 6mm

b) only with screw diameter 8mm

c) only with screw diameter 10mm

d) Screw type: W: Wood-screw C: Chipboard screw

Load data are valid for the mentioned woodscrew type, if other types or different screws are used the load capacity may decrease.

Recommended loads ^{e)}

Anchor size	Screw type ^{d)}	5x25		6x30		8x40		10x50		12x60	14x70
		W	C	W	C	W	C	W	C	W	W
Concrete ≥ C16/20	N _{rec} [kN]	0,3	0,1	0,55	0,35	0,85	0,5	1,4		2	3
	V _{rec} [kN]	0,4		0,9		1,25		2,2		3	5,6
Solid clay brick Mz 20	N _{rec} [kN]	0,17	0,06	0,35	0,15	0,6	0,35	0,8		1	1
	V _{rec} [kN]	0,24		0,3		0,44					
Solid sand-lime brick KS 12	N _{rec} [kN]	0,25	0,15	0,5	0,3	0,85	0,4	1		1,5	1,5
	V _{rec} [kN]	0,25		0,56		0,74		1,32			
Hollow clay brick HzB 12	N _{rec} [kN]	0,08	0,05	0,1	0,08	0,2	0,12	0,25		0,28	0,32
	V _{rec} [kN]	0,23		0,35							
Hollow clay brick HzB 12 – 15mm plastered	N _{rec} [kN]	0,08	0,05	0,15	0,1	0,25	0,15	0,3		0,35	0,4
	V _{rec} [kN]	0,23		0,35							
Autoclaved aerated concrete AAC 2	N _{rec} [kN]	0,06	0,04	0,1	0,06	0,15	0,1	0,2		0,25	0,3
	V _{rec} [kN]	0,04		0,05		0,08					
Autoclaved aerated concrete AAC 4	N _{rec} [kN]	0,1	0,06	0,15	0,1	0,3	0,2	0,4		0,5	0,6
	V _{rec} [kN]	0,13		0,18		0,3					
Gypsum board Thickness 12,5mm	N _{rec} [kN]	0,04	0,06	0,05	0,08	0,06	0,1		0,15		
	V _{rec} [kN]	0,09		0,14							
Gypsum board Thickness 2x12,5mm	N _{rec} [kN]	0,06	0,06	0,08	0,08	0,1	0,1	0,15	0,2	0,3	
	V _{rec} [kN]	0,09		0,14							
Fibre reinforced gypsum board Thickness 12,5mm	N _{rec} [kN]	0,09		0,12		0,18					
	V _{rec} [kN]	0,14		0,19		0,29					
Fibre reinforced gypsum board Thickness 2x12,5mm	N _{rec} [kN]	0,09		0,24		0,36		0,42			
	V _{rec} [kN]	0,14		0,38		0,58		0,67			

a) only with screw diameter 6mm

b) only with screw diameter 8mm

c) only with screw diameter 10mm

d) Screw type: W: Wood-screw C: Chipboard screw

Load data are valid for the mentioned woodscrew type, if other types or different screws are used the load capacity may decrease.

e) With overall global safety factor $\gamma = 5$ to the characteristic loads and a partial safety factor of $\gamma = 1,4$ to the design values.

Service temperature range

Hilti HUD-1 universal anchor may be applied in the temperature range given below.

Temperature range	Base material temperature	Maximum long term base material temperature	Maximum short term base material temperature
Temperature range	-40 °C to +80 °C	+50 °C	+80 °C

Max short term base material temperature

Short-term elevated base material temperatures are those that occur over brief intervals, e.g. as a result of diurnal cycling.

Max long term base material temperature

Long-term elevated base material temperatures are roughly constant over significant periods of time.

Materials

Material quality

Part	Material
Plastic sleeve	Polyamide 6

Setting

Installation equipment

Anchor size	5x25	6x30	8x40	10x50	12x60	14x70
Rotary hammer	TE 2 – TE 16					
Other tools	Screwdriver					

Setting instruction

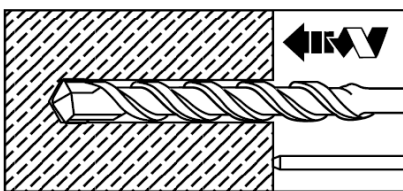

Drill hole with drill bit.

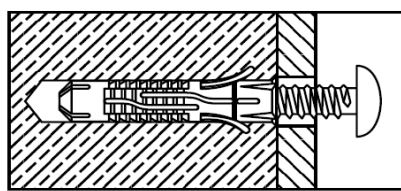

Install anchor.

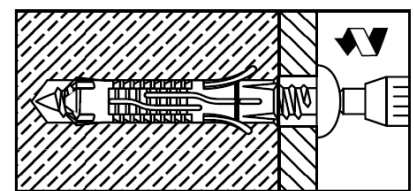

Drive screw into anchor.

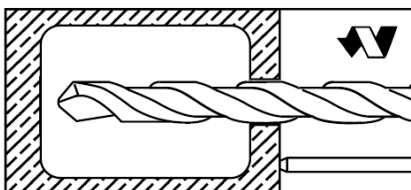

Drill hole with drill bit.

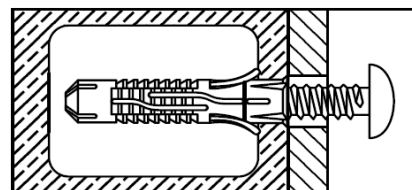

Install anchor.

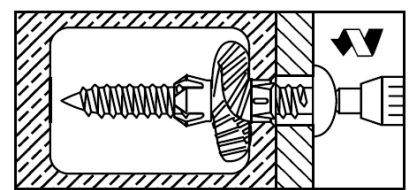

Drive screw into anchor.

Use only for wall and floor applications. Not applicable for ceiling and façade applications.

For detailed information on installation see instruction for use given with the package of the product.

Setting details: depth of drill hole h_1 and effective anchorage depth h_{ef}

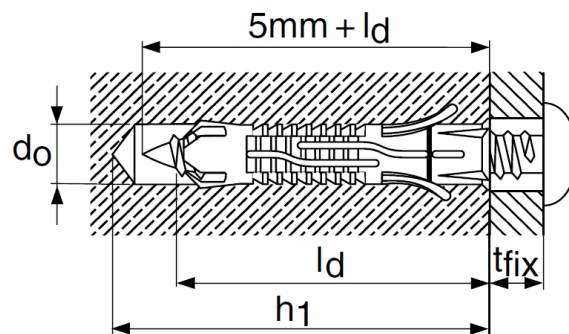



Setting details HUD-1

Anchor version		5x25	6x30	8x40	10x50	12x60	14x70
Nominal diameter of drill bit	d_o [mm]	5	6	8	10	12	14
Cutting diameter of drill bit	$d_{cut} \leq$ [mm]	5,35	6,4	8,45	10,45	12,5	14,5
Depth of drill hole	$h_1 \geq$ [mm]	35	40	55	65	80	90
Effective anchorage depth	h_{nom} [mm]	25	30	40	50	60	70
Anchor length	l [mm]	25	30	40	50	60	70
Max fixture thickness	t_{fix} [mm]	Depending on screw length					
Installation temperature	[°C]	-10 to +40					
Woodscrew diameter ^{a)}	d [mm]	3,5 - 4	4,5 - 5	5 - 6	7 - 8	8 - 10	10 - 12

- a) The basic loading data are depending on the woodscrew diameters, if other types or different screws are used the load capacity may decrease. Highlighted diameters refer to basic loading data table, except footnotes ^{a),b),c)} of basic loading data tables.

HUD-L Universal anchor

	Anchor version	Benefits
	HUD-L 6 HUD-L 8	<ul style="list-style-type: none"> - universal plastic anchor for weak base materials and renovation - for many base materials - daily application - excellent setting behaviour
	HUD-L 10	

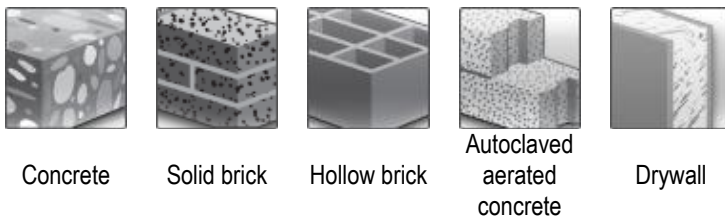

Concrete Solid brick Hollow brick Autoclaved aerated concrete Drywall

Basic loading data (for a single anchor)

All data in this section applies to

- Correct setting (See setting instruction)
- Load data are only valid for the specified woodscrew type
- Load data given in the tables is independent of load direction
- No edge distance and spacing influence
- Base material as specified in the table
- Minimum base material thickness

Characteristic resistance

Anchor size		HUD-L 6x50	HUD-L 8x60	HUD-L 10x70
	Screw type ^{o)}	Woodscrew 4,5x80 DIN 96	Woodscrew 5x90 DIN 96	Woodscrew 8mm DIN 571
Concrete ≥ C16/20	F _{Rk} [kN]	1,15	1,4	9,0
Solid clay brick Mz 12	F _{Rk} [kN]	0,85	1,0	-
Solid clay brick Mz 20	F _{Rk} [kN]	-	-	7,0
Solid sand-lime brick KS 12	F _{Rk} [kN]	0,85	1,0	2
Hollow clay brick Hz 12 ^{a)}	F _{Rk} [kN]	0,5	0,75	1,5
Hollow sand-lime brick KSL 12	F _{Rk} [kN]	0,7	0,8	-
Autoclaved aerated concrete AAC 2 ^{a)}	F _{Rk} [kN]	0,25	0,55	2,0
Gypsum board Thickness 2x12,5mm ^{a)}	F _{Rk} [kN]	0,3	0,7	0,6 ^{b)}

a) Drilling without hammering

b) Suitable for fitting hexagonal screws by hand

c) Load data are valid for the mentioned woodscrew type, if other types or different screws are used the load capacity may decrease.

Design resistance

Anchor size		HUD-L 6x50	HUD-L 8x60	HUD-L 10x70
	Screw type ^{c)}	Woodscrew 4,5x80 DIN 96	Woodscrew 5x90 DIN 96	Woodscrew 8mm DIN 571
Concrete ≥ C16/20	F _{Rd} [kN]	0,32	0,39	2,52
Solid clay brick Mz 12	F _{Rd} [kN]	0,24	0,28	-
Solid clay brick Mz 20	F _{Rd} [kN]	-	-	1,96
Solid sand-lime brick KS 12	F _{Rd} [kN]	0,24	0,28	0,56
Hollow clay brick Hz 12 ^{a)}	F _{Rd} [kN]	0,14	0,21	0,42
Hollow sand-lime brick KSL 12	F _{Rd} [kN]	0,20	0,22	-
Autoclaved aerated concrete AAC 2 ^{a)}	F _{Rd} [kN]	0,07	0,15	0,56
Gypsum board Thickness 2x12,5mm ^{a)}	F _{Rd} [kN]	0,08	0,20	0,17 ^{b)}

a) Drilling without hammering

b) Suitable for fitting hexagonal screws by hand

c) Load data are valid for the mentioned woodscrew type, if other types or different screws are used the load capacity may decrease.

Recommended loads ^{d)}

Anchor size		HUD-L 6x50	HUD-L 8x60	HUD-L 10x70
	Screw type ^{c)}	Woodscrew 4,5x80 DIN 96	Woodscrew 5x90 DIN 96	Woodscrew 8mm DIN 571
Concrete ≥ C16/20	F _{rec} [kN]	0,23	0,28	1,8
Solid clay brick Mz 12	F _{rec} [kN]	0,17	0,2	-
Solid clay brick Mz 20	F _{rec} [kN]	-	-	1,4
Solid sand-lime brick KS 12	F _{rec} [kN]	0,17	0,2	0,4
Hollow clay brick Hz 12 ^{a)}	F _{rec} [kN]	0,1	0,15	0,3
Hollow sand-lime brick KSL 12	F _{rec} [kN]	0,14	0,16	-
Autoclaved aerated concrete AAC 2 ^{a)}	F _{rec} [kN]	0,05	0,11	0,4
Gypsum board Thickness 2x12,5mm ^{a)}	F _{rec} [kN]	0,06	0,14	0,12 ^{b)}

a) Drilling without hammering

b) Suitable for fitting hexagonal screws by hand

c) Load data are valid for the mentioned woodscrew type, if other types or different screws are used the load capacity may decrease.

d) With overall global safety factor $\gamma = 5$ to the characteristic loads and a partial safety factor of $\gamma = 1,4$ to the design values.

Service temperature range

Hilti HUD-L universal anchor may be applied in the temperature range given below.

Temperature range	Base material temperature	Maximum long term base material temperature	Maximum short term base material temperature
Temperature range	-40 °C to +80 °C	+50 °C	+80 °C

Max short term base material temperature

Short-term elevated base material temperatures are those that occur over brief intervals, e.g. as a result of diurnal cycling.

Max long term base material temperature

Long-term elevated base material temperatures are roughly constant over significant periods of time.

Materials

Material quality

Part	Material
Plastic sleeve	Polyamide 6

Setting

Installation equipment

Anchor size	HUD-L 6x50	HUD-L 8x60	HUD-L 10x70
Rotary hammer	TE 2 – TE 16		
Other tools	Screwdriver		

Setting instruction

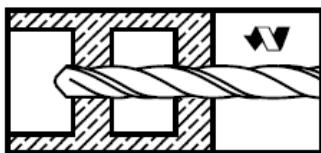

Drill hole with drill bit.

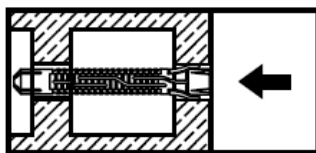

Install anchor.

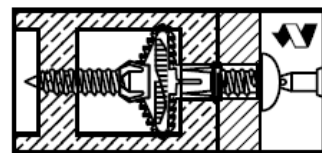

Put part being fastened in place and drive screw into anchor.

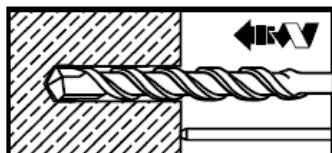

Drill hole with drill bit.

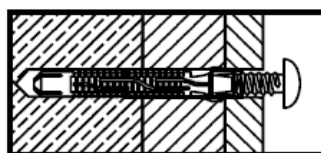

Put part being fastened in place and install anchor.

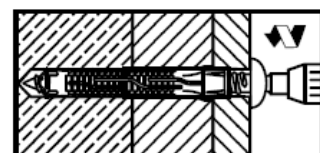

Drive screw into anchor.

Use only for wall and floor applications. Not applicable for ceiling and façade applications.

For detailed information on installation see instruction for use given with the package of the product.

Setting details: depth of drill hole h_1 and effective anchorage depth h_{ef}

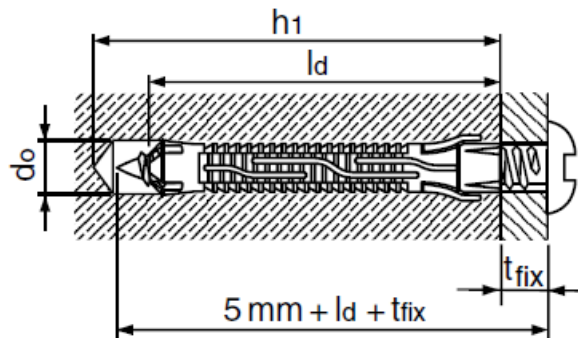

Setting details HUD-L

Anchor version HUD-L		HUD-L 6x50	HUD-L 8x60	HUD-L 10x70
Nominal diameter of drill bit	d_o [mm]	6	8	10
Cutting diameter of drill bit	$d_{cut} \leq$ [mm]	6,4	8,45	10,45
Depth of drill hole	$h_1 \geq$ [mm]	70	80	90
Effective anchorage depth	h_{nom} [mm]	47	57	70
Anchor length	l [mm]	47	57	70
Max fixture thickness	t_{fix} [mm]	Depending on screw length		
Installation temperature	[°C]	-10 to +40		
Recommended length of screw in base material	l_d [mm]	55	65	75
Woodscrew diameter ^{a)}	d [mm]	4,5 - 5	5 - 6	7 - 8

a) The basic loading data are depending on the woodscrew diameters, if other types or different screws are used the load capacity may decrease. Highlighted diameters refer to basic loading data table.

HLD Light duty anchor

Anchor version	Benefits
 <p style="text-align: center;">HLD</p>	<ul style="list-style-type: none"> - plastic undercut anchor - simple setting - esp. for drywall applications



Drywall

Basic loading data (for a single anchor)

All data in this section applies to

- Correct setting (See setting instruction)
- No edge distance and spacing influence
- Base material as specified in the table
- Load data given in the tables is independent of load direction

Characteristic resistance

Anchor size			HLD 2	HLD 3	HLD 4
Anchoring principle ^{a)}					
Gypsum board Thickness 12,5mm	B	F_{Rk} [kN]	0,4	0,4	0,4
Fibre reinforced gypsum board Thickness 12,5mm	A	F_{Rk} [kN]	0,3	-	-
Fibre reinforced gypsum board Thickness 2x12,5mm	A	F_{Rk} [kN]	-	0,6	-
Hollow clay brick	A / B	F_{Rk} [kN]	0,75	0,75	
Concrete \geq C16/20	C	F_{Rk} [kN]	1,25	2	2,5

a) See setting details

Design resistance

Anchor size	Anchoring principle ^{a)}			HLD 2	HLD 3	HLD 4
Gypsum board Thickness 12,5mm	B	F_{Rd}	[kN]	0,11	0,11	0,11
Fibre reinforced gypsum board Thickness 12,5mm	A	F_{Rd}	[kN]	0,08	-	-
Fibre reinforced gypsum board Thickness 2x12,5mm	A	F_{Rd}	[kN]	-	0,17	-
Hollow clay brick	A / B	F_{Rd}	[kN]	0,21	0,21	-
Concrete \geq C16/20	C	F_{Rd}	[kN]	0,35	0,56	0,70

a) See setting details

Recommended loads ^{b)}

Anchor size	Anchoring principle ^{a)}			HLD 2	HLD 3	HLD 4
Gypsum board Thickness 12,5mm	B	F_{rec}	[kN]	0,08	0,08	0,08
Fibre reinforced gypsum board Thickness 12,5mm	A	F_{rec}	[kN]	0,06	-	-
Fibre reinforced gypsum board Thickness 2x12,5mm	A	F_{rec}	[kN]	-	0,12	-
Hollow clay brick	A / B	F_{rec}	[kN]	0,15	0,15	-
Concrete \geq C16/20	C	F_{rec}	[kN]	0,25	0,4	0,5

a) See setting details

b) With overall global safety factor $\gamma = 5$ to the characteristic loads and a partial safety factor of $\gamma = 1,4$ to the design values.

Service temperature range

Hilti HLD light duty anchor may be applied in the temperature range given below.

Temperature range	Base material temperature	Maximum long term base material temperature	Maximum short term base material temperature
Temperature range	-40 °C to +80 °C	+50 °C	+80 °C

Max short term base material temperature

Short-term elevated base material temperatures are those that occur over brief intervals, e.g. as a result of diurnal cycling.

Max long term base material temperature

Long-term elevated base material temperatures are roughly constant over significant periods of time.

Materials

Material quality

Part	Material
Sleeve	Polyamide PA 6

Setting

Installation equipment

Anchor size		
Rotary hammer		TE 2 – TE 16
Other tools		Screwdriver

Setting instruction

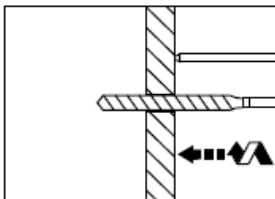

Drill hole with drill bit.

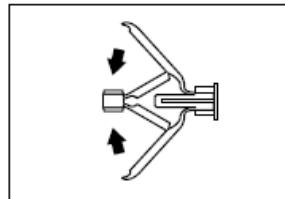

Install the HLD anchor.

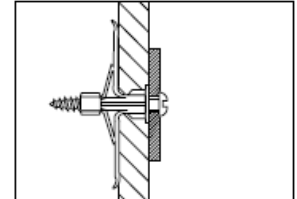
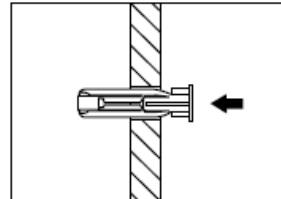

Drive in the screw.

For detailed information on installation see instruction for use given with the package of the product.

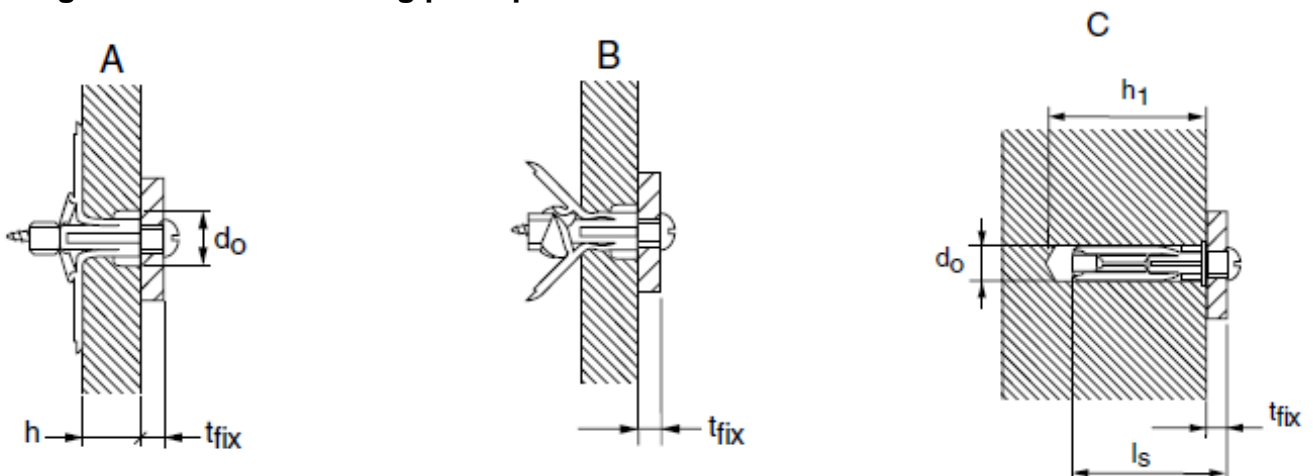

Setting details and anchoring principles:



Setting details HSP / HFP

Anchor version			HLD 2	HLD 3	HLD 4
Nominal diameter of drill bit	d_o	[mm]	10		
Depth of drill hole	(only anchoring principle C) $h_1 \geq$	[mm]	50	56	66
Screw length	(anchoring principle A/B) l_s	[mm]	$33 + t_{fix}$	$40 + t_{fix}$	$49 + t_{fix}$
	(anchoring principle C) l_s	[mm]	$40 + t_{fix}$	$46 + t_{fix}$	$56 + t_{fix}$
Screw diameter	(anchoring principle A/B) d_s	[mm]	4 – 5		
	(anchoring principle C) d_s	[mm]	5 – 6		
Wall / panel thickness	(anchoring principle A) h	[mm]	4 – 12	15 – 19	24 – 28
	(anchoring principle B) h	[mm]	12 – 16	19 – 25	28 – 32
	(anchoring principle C) $h \geq$	[mm]	35	42	50
Installation temperature		[°C]	-10 to +40		

HRD-U 10 / - S 10 / -U 14 Frame anchor

Anchor version		Benefits
	HRD-U 10 Carbon steel Stainless steel	- universal frame anchor for façade, steelwork, and mechanical installation - base material versatility - excellent setting behaviour
	HRD-S 10 Carbon steel Stainless steel	
	HRD-U 14 Carbon steel Stainless steel	



Concrete

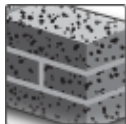

Solid brick

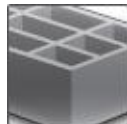

Hollow brick

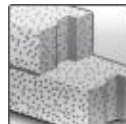

Autoclaved
aerated
concrete



Fire
resistance

Approvals / certificates

Description	Authority / Laboratory	No. / date of issue
Fire test report	IBMB, Braunschweig	UB 3613/3891-1 Nau / 2001-11-23 UB 3613/3891-2 Nau / 2001-11-26

Basic loading data (for a single anchor)

All data in this section applies to

- Correct setting (See setting instruction)
- No edge distance and spacing influence
- Base materials as specified in the table
Minimum base material thickness
- Anchor is set in the brick, not in the joints

Recommended loads

Anchor size			HRD-U 10	HRD-S 10	HRD-U 14
Concrete	≥ C12/15	F_{rec} [kN]	1,6	1,2	1,8
Solid clay brick	Mz 12	F_{rec} [kN]	0,6	0,6	0,6
Solid clay brick	Mz 20	F_{rec} [kN]	1,2	0,8	1,25
Solid sand-lime brick	KS 12/2,0	F_{rec} [kN]	0,6	0,6	0,6
Lightweight solid block	V 2	F_{rec} [kN]	0,25	0,25	0,5
Hollow clay brick	Hlz 12 – 1,0	F_{rec} [kN]	0,3	-	0,5
Hollow sand-lime brick	KSL 6	F_{rec} [kN]	0,4	0,4	0,6
Lightweight hollow brick	Hbl 2	F_{rec} [kN]	0,25	0,25	0,3
AAC blocks	AAC 2	F_{rec} [kN]	0,2	0,2	0,3
	≥ AAC 4	F_{rec} [kN]	0,5	0,35	0,6
AAC members	P 3,3	F_{rec} [kN]	0,2	0,2	0,3
	≥ P 4,4	F_{rec} [kN]	0,5	0,35	0,6
AAC acc. TGL	Plant Laussig	F_{rec} [kN]	0,3	-	-
	Plant Parchim	F_{rec} [kN]	0,15	-	-
Thin skins of external wall panels		F_{rec} [kN]	0,6	0,6	-
hwpLb acc. TGL		F_{rec} [kN]	0,5	-	0,7

Service temperature range

Hilti HRD-U 10 / -S 10 / -U 14 frame anchor may be applied in the temperature range given below.

Temperature range	Base material temperature	Maximum long term base material temperature	Maximum short term base material temperature
Temperature range	-40 °C to +80 °C	+50 °C	+80 °C

Max short term base material temperature

Short-term elevated base material temperatures are those that occur over brief intervals, e.g. as a result of diurnal cycling.

Max long term base material temperature

Long-term elevated base material temperatures are roughly constant over significant periods of time.

Materials

Mechanical properties of HRD-U 10 / S 10 / U 14

Anchor size		U 10	S 10	U 14
Nominal tensile strength f_{uk}	Carbon steel [N/mm ²]	600		
	Stainless steel [N/mm ²]	580		500
Yield strength f_{yk}	Carbon steel [N/mm ²]	480		
	Stainless steel [N/mm ²]	450		400
Stressed cross-section A_s	[mm ²]	31,2		56,8
Moment of resistance W	[mm ³]	24,6		60,4
Char. bending resistance $M_{Rk,s}^0$	Carbon steel [Nm]	17,7		43,5
	Stainless steel [Nm]	17,1		36,2

The recommended bending moment shall be calculated by dividing the characteristic bending moment by 1,4 and 1,25

Material quality

Part		Material
Sleeve	HRD	Polyamide
Screw	HRD-UG	Carbon steel, galvanised to min. 5 µm
	HRD-UR	Stainless steel

Anchor dimensions

Anchor size			U 10	S 10	U 14	UP 14
Minimum thickness of fixture	$t_{fix,min}$	[mm]	10	10	10	10
Maximum thickness of fixture	$t_{fix,max}$	[mm]	160	130	280	250
Diameter of the sleeve	d_{nom}	[mm]	10	10	14	14
Minimum length of the sleeve	$l_{1,min}$	[mm]	80	60	80	110
Maximum length of the sleeve	$l_{1,max}$	[mm]	230	180	350	330
Diameter of the screw	d_s	[mm]	7	7	10	10
Minimum length of the screw	$l_{2,min}$	[mm]	85	65	85	115
Maximum length of the screw	$l_{2,max}$	[mm]	235	285	355	335

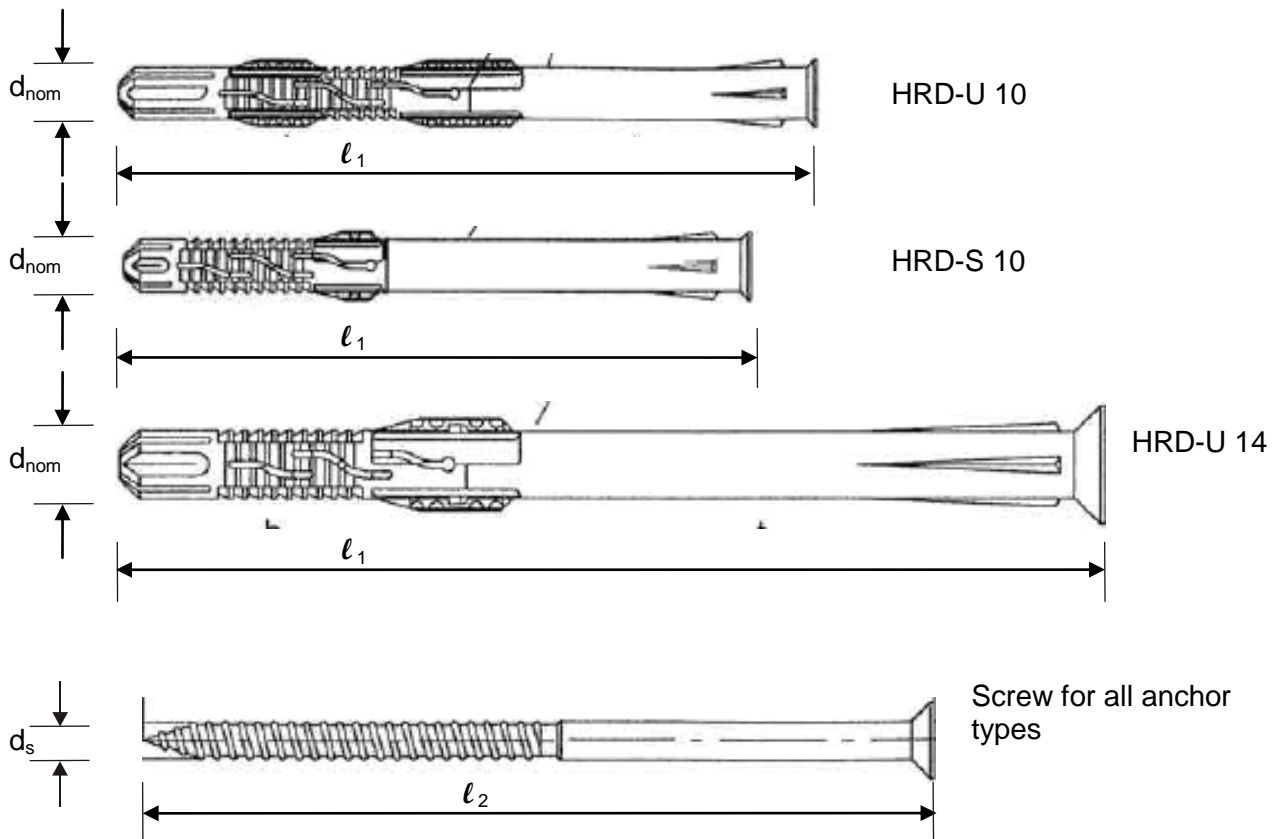

Setting

Installation equipment

Anchor size	U 10	S 10	U 14
Rotary hammer	TE2 ... TE16		TE16... TE40
Other tools	hammer, screw driver		

Setting instruction

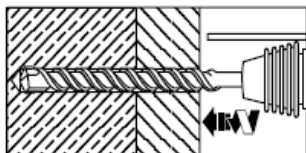

Drill hole with drill bit.

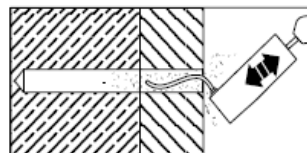

Blow out dust and fragments.

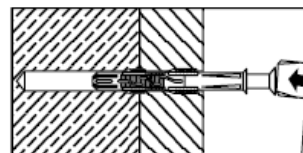

Install anchor.

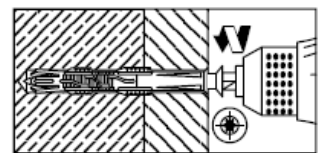

Drive screw into anchor.

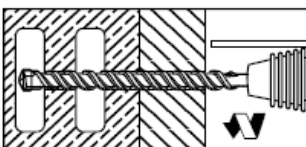

Drill hole with drill bit.

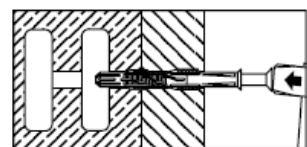

Install anchor.

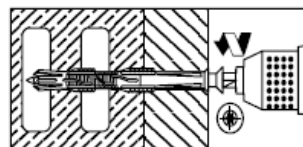

Drive screw into anchor.

For detailed information on installation see instruction for use given with the package of the product.

For technical data for anchors in diamond drilled holes please contact the Hilti Technical advisory service.

Setting details: depth of drill hole h_1 and effective anchorage depth h_{nom}

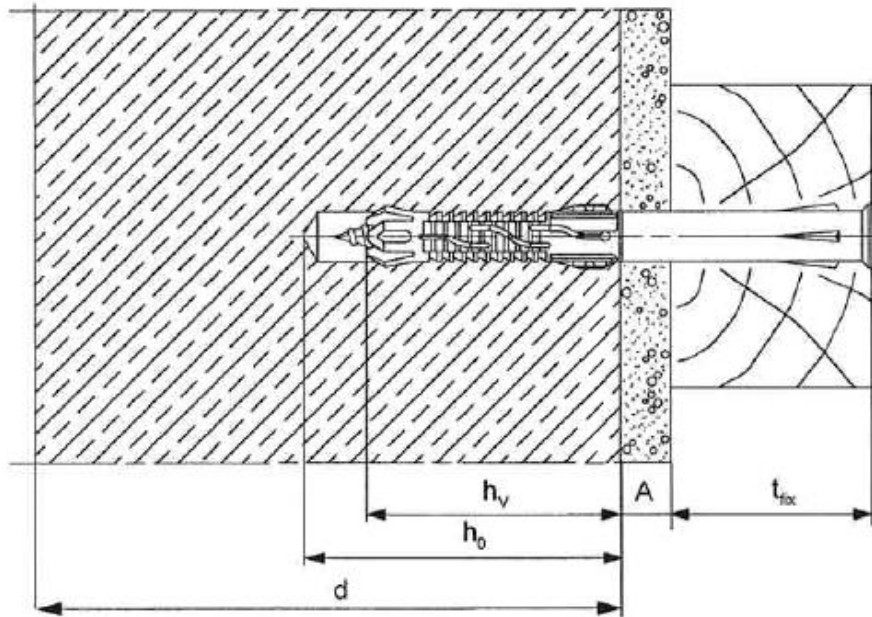

Setting details HRD-U 10 / S 10 / U 14

		U 10	S 10	U 14
Nominal diameter of drill bit	d_o [mm]	10	10	14
Cutting diameter of drill bit	$d_{cut} \leq$ [mm]	10,45	10,45	14,5
Depth of drill hole	$h_1 \geq$ [mm]	80	60	85
Diameter of clearance hole in the fixture	$d_f \leq$ [mm]	10,5	10,5	14,5
Overall embedment depth in the base material	h_{nom} [mm]	70	50	70
Installation temperature	[°C]	-10 - +40		

Base material thickness, anchor spacing and edge distance

Anchor size				U 10	S 10	U 14
Minimum base material thickness	Concrete	h_{min}	[mm]	120	100	120
	Masonry	h_{min}	[mm]	115	115	115
	AAC	h_{min}	[mm]	115	115	115
	Wetterschale	h_{min}	[mm]	40	40	-
	hwpLb	h_{min}	[mm]	40	40	-
Minimum spacing of single anchors	Concrete	s_{min}	[mm]	150	100	150
	Solid masonry	s_{min}	[mm]	100	100	250
	Hollow masonry	s_{min}	[mm]	250	250	250
	AAC	s_{min}	[mm]	100 ^{a)}	-	-
	Wetterschale	s_{min}	[mm]	100	100	-
hwpLb	s_{min}	[mm]	100	-	100	
Minimum spacing in a group in concrete		s_{min1}	[mm]	50	50	50
Minimum spacing of groups in concrete		s_{min2}	[mm]	300	240	300
Minimum edge distance	Concrete	c_{min}	[mm]	100	80	100
	Solid masonry	c_{min}	[mm]	100	100	100
	Hollow masonry	c_{min}	[mm]	100	100	100
	AAC	c_{min}	[mm]	150	-	-
	Wetterschale	c_{min}	[mm]	50	50	-
	hwpLb	c_{min}	[mm]	100	100	100

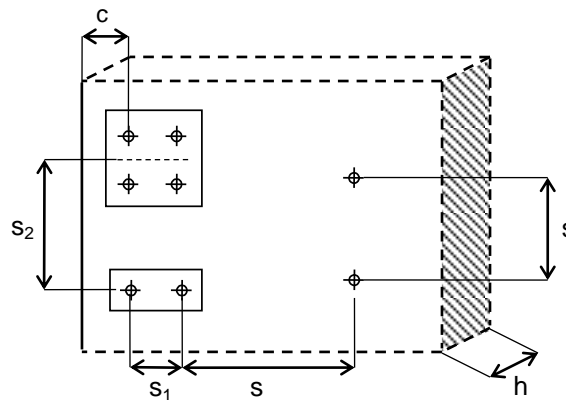

HRD Frame anchor, Redundant fastening

	Anchor version	Benefits
	HRD-C 8x HRD CR 8x	Innovative screw design for better hold Suitable on practically all base materials
	HRD-C 10x... HRD-CR 10x... HRD-CR2 10x...	Flexible embedment depth (approved at 50mm and 70mm)
	HRD-H 10x... HRD-HR 10x... HRD-HR2 10x... HRD-HF 10x...	Suitable for fastening thicknesses up to 260mm
	HRD-K 10x... HRD-KR 10x... HRD-KR2 10x...	Available in 4 different materials for optimum suitability in all corrosive environments
	HRD-P 10x... HRD-PR 10x... HRD-PR2 10x...	Pre-assembled for optimum handling and fastening quality



Concrete



Tensile zone^{a)}

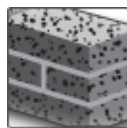

Solid brick

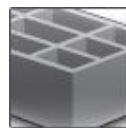

Hollow brick

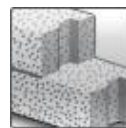

Autoclaved aerated concrete



Prestressed hollow core slabs



Window frame



Fire resistance



CE conformity



European Technical Approval

a) Redundant fastening only

Approvals / certificates

Description	Authority / Laboratory	No. / date of issue
European technical approval ^{a)}	DIBt, Berlin	ETA-07/0219 / 2012-09-18
Fire test report	MFPA, Leipzig	GS 3.2/10-157-1/ 2010-09-02
Window frame report ^{b)}	Ift, Rosenheim	Ift report 105 33035 / 2007-07-09

a) All data given in this section according ETA-07/0219, issue 2012-09-18. The anchor is to be used only for redundant fastening for non-structural applications.

b) only available for HRD 8

c) only valid for HRD 10

Basic loading data according ETAG 020**All data in this section applies to**

- Correct setting (See setting instruction)
- No edge distance and spacing influence
- Base material as specified in the table
Minimum base material thickness
- *Steel* failure
- Shear without lever arm
- Anchors in redundant fastening

- The data that are highlighted in light grey are additional Hilti recommended data and not part of the approval

Characteristic resistance

Anchor size				HRD 8	HRD 10		
				h_{nom} =50mm	h_{nom} =50mm	h_{nom} =70mm	h_{nom} =90mm
Concrete C 12/15	N_{Rk} [kN]		2,0	3,0	6,0	-	
	V_{Rk} [kN]		6,9 / 6,6 ^{b)}	10,6 / 10,1 ^{b)} / 11,1 ^{c)}		-	
Concrete C 16/20 –C 50/60	N_{Rk} [kN]		3,0	4,5	8,5	-	
	V_{Rk} [kN]		6,9 / 6,6 ^{b)}	10,6 / 10,1 ^{b)} / 11,1 ^{c)}		-	
Solid clay brick Mz 2,0 DIN V 105-100 / EN 771-1	$f_b \geq 20 \text{ N/mm}^2$	F_{Rk} [kN]	1,5	3,0 4,5 ^{d)}	f)	-	
	$f_b \geq 10 \text{ N/mm}^2$	F_{Rk} [kN]	1,2	2,0 3,0 ^{d)}	f)	-	
Solid sand-lime brick KS 2,0 DIN V 106 / EN 771-2	$f_b \geq 20 \text{ N/mm}^2$	F_{Rk} [kN]	2,5	3,0 4,5 ^{d)}	f)	-	
	$f_b \geq 10 \text{ N/mm}^2$	F_{Rk} [kN]	2,0	2,0 3,0 ^{d)}	f)	-	
Lightweight solid block Vbl 0,9 DIN V 18151-100 / EN 771-3	$f_b \geq 20 \text{ N/mm}^2$	F_{Rk} [kN]	-	3,5 6,0 ^{d)}	f)	-	
	$f_b \geq 10 \text{ N/mm}^2$	F_{Rk} [kN]	-	2,5 4,5 ^{d)}	f)	-	
	$f_b \geq 6 \text{ N/mm}^2$	F_{Rk} [kN]	0,50	-	-	-	
Ital. solid brick Tufo	$f_b \geq n/a$	F_{Rk} [kN]	1,4	-	-	-	
Hollow clay brick Hlz B 12/1,2 A ^{e)}	brick $f_b \geq 12 \text{ N/mm}^2$	F_{Rk} [kN]	0,50	-	-	-	
Vertically perforated clay brick Hlz 1,2-2DF F ^{e)}	brick $f_b \geq 8 \text{ N/mm}^2$	F_{Rk} [kN]	-	1,5	-	-	
	$f_b \geq 10 \text{ N/mm}^2$	F_{Rk} [kN]	-	2,0	-	-	
	$f_b \geq 12 \text{ N/mm}^2$	F_{Rk} [kN]	-	2,0	-	-	
Vertically perforated clay brick Hlz 1,0-2DF G ^{e)}	brick $f_b \geq 8 \text{ N/mm}^2$	F_{Rk} [kN]	-	0,4	0,75	-	
	$f_b \geq 10 \text{ N/mm}^2$	F_{Rk} [kN]	-	0,5	0,9	-	
	$f_b \geq 12 \text{ N/mm}^2$	F_{Rk} [kN]	-	0,6	0,9	-	
	$f_b \geq 20 \text{ N/mm}^2$	F_{Rk} [kN]	-	0,9	1,5	-	
Vertically perforated clay brick VHlz 1,6-2DF brick H ^{e)}	$f_b \geq 28 \text{ N/mm}^2$	F_{Rk} [kN]	-	2,0	2,5	-	
	$f_b \geq 50 \text{ N/mm}^2$	F_{Rk} [kN]	-	3,0	3,5	-	
Vertically perforated clay brick Poroton T8 M ^{e)}	brick $f_b \geq 6 \text{ N/mm}^2$	F_{Rk} [kN]	-	0,75	1,5	-	
Vertically perforated clay brick Hlz 1,0-9DF L ^{e)}	brick $f_b \geq 8 \text{ N/mm}^2$	F_{Rk} [kN]	-	1,2	1,5	-	
	$f_b \geq 10 \text{ N/mm}^2$	F_{Rk} [kN]	-	1,5	1,5	-	
	$f_b \geq 12 \text{ N/mm}^2$	F_{Rk} [kN]	-	1,5	2,0	-	
	$f_b \geq 16 \text{ N/mm}^2$	F_{Rk} [kN]	-	2,0	3,0	-	

Characteristic resistance

Anchor size					HRD 8	HRD 10		
					h_{nom} =50mm	h_{nom} =50mm	h_{nom} =70mm	h_{nom} =90mm
Hollow sand-lime brick KSL 12/1,4 O^{e)}	brick	$f_b \geq 12 \text{ N/mm}^2$	F_{Rk}	[kN]	0,75	-	-	-
Vertically perforated sand-lime brick KSL 1,6-2DF	brick P^{e)}	$f_b \geq 8 \text{ N/mm}^2$	F_{Rk}	[kN]	-	1,5	-	-
		$f_b \geq 10 \text{ N/mm}^2$	F_{Rk}	[kN]	-	1,5	-	-
		$f_b \geq 12 \text{ N/mm}^2$	F_{Rk}	[kN]	-	2,0	-	-
Vertically perforated sand-lime brick KSL 1,4-3DF	brick Q^{e)}	$f_b \geq 8 \text{ N/mm}^2$	F_{Rk}	[kN]	-	-	2,0	-
		$f_b \geq 10 \text{ N/mm}^2$	F_{Rk}	[kN]	-	-	2,5	-
		$f_b \geq 12 \text{ N/mm}^2$	F_{Rk}	[kN]	-	-	3,0	-
Vertically perforated sand-lime brick KSL R 1,6-16DF R^{e)}	brick	$f_b \geq 8 \text{ N/mm}^2$	F_{Rk}	[kN]	-	0,9	1,2	-
		$f_b \geq 10 \text{ N/mm}^2$	F_{Rk}	[kN]	-	1,2	1,5	-
		$f_b \geq 12 \text{ N/mm}^2$	F_{Rk}	[kN]	-	1,5	2,0	-
		$f_b \geq 16 \text{ N/mm}^2$	F_{Rk}	[kN]	-	2,0	2,5	-
Lightweight hollow brick Hbl 2/0,8 S^{e)}	brick	$f_b \geq 2 \text{ N/mm}^2$	F_{Rk}	[kN]	0,30	-	-	-
Lightweight concrete hollow block Hbl 1,2-12DF	brick T^{e)}	$f_b \geq 2 \text{ N/mm}^2$	F_{Rk}	[kN]	-	0,5	0,75	-
		$f_b \geq 6 \text{ N/mm}^2$	F_{Rk}	[kN]	-	1,2	2,0	-
Ital. Hollow brick Mattone E^{e)}	brick	$f_b \geq 22 \text{ N/mm}^2$	F_{Rk}	[kN]	1,5	-	-	-
Ital. Hollow brick Poroton P700	brick N^{e)}	$f_b \geq 15 \text{ N/mm}^2$	F_{Rk}	[kN]	-	-	0,6	-
Ital. Hollow brick Doppio Uni C+I^{e)}	brick	$f_b \geq 25 \text{ N/mm}^2$	F_{Rk}	[kN]	0,9 (C)	-	1,5 (I)	-
Span. Hollow brick Rojo hidrofugano D^{e)}	brick	$f_b \geq 40 \text{ N/mm}^2$	F_{Rk}	[kN]	0,60	-	-	-
Span. Hollow brick Ladrillo perforado J^{e)}	brick	$f_b \geq 26 \text{ N/mm}^2$	F_{Rk}	[kN]	-	1,5	2,0	-
Span. Hollow brick Clinker mediterraneo	brick K^{e)}	$f_b \geq 75 \text{ N/mm}^2$	F_{Rk}	[kN]	-	-	1,5	-
French Hollow brick Brique Creuse	brick B^{e)}	$f_b \geq 6 \text{ N/mm}^2$	F_{Rk}	[kN]	0,50	-	-	-
Autoclaved aerated concrete AAC		AAC 2	F_{Rk}	[kN]	-	-	0,9	0,9
		AAC 4	F_{Rk}	[kN]	-	-	2,0	2,5
		AAC 6	F_{Rk}	[kN]	-	-	2,0	2,5
		AAC 6	F_{Rk}	[kN]	-	-	3,5 ^{d)}	4,5 ^{d)}

Design resistance

Anchor size			HRD 8	HRD 10		
			h_{nom} =50mm	h_{nom} =50mm	h_{nom} =70mm	h_{nom} =90mm
Concrete C 12/15	N_{Rd} [kN]		1,1	1,7	3,3	-
	V_{Rd} [kN]		5,5 / 5,2 ^{b)}	8,5 / 8,1 ^{b)} / 8,5 ^{c)}		-
Concrete C 16/20 –C 50/60	N_{Rd} [kN]		1,7	2,5	4,7	-
	V_{Rd} [kN]		5,5 / 5,2 ^{b)}	8,5 / 8,1 ^{b)} / 8,5 ^{c)}		-
Solid clay brick Mz 2,0 DIN V 105-100 / EN 771-1	$f_b \geq 20 \text{ N/mm}^2$	F_{Rd} [kN]	0,6	1,2 1,8 ^{d)}	f)	-
	$f_b \geq 10 \text{ N/mm}^2$	F_{Rd} [kN]		0,8 1,2 ^{d)}		
Solid sand-lime brick KS 2,0 DIN V 106 / EN 771-2	$f_b \geq 20 \text{ N/mm}^2$	F_{Rd} [kN]	1,0	1,2 1,8 ^{d)}	f)	-
	$f_b \geq 10 \text{ N/mm}^2$	F_{Rd} [kN]		0,8 1,2 ^{d)}		
Lightweight solid block Vbl 0,9 DIN V 18151-100 / EN 771-3	$f_b \geq 20 \text{ N/mm}^2$	F_{Rd} [kN]	-	1,4 2,4 ^{d)}	f)	-
	$f_b \geq 10 \text{ N/mm}^2$	F_{Rd} [kN]		1,0 1,8 ^{d)}		
	$f_b \geq 6 \text{ N/mm}^2$	F_{Rd} [kN]		0,2		
Ital. solid brick Tufo	$f_b \geq n/a$	F_{Rd} [kN]	0,56	-	-	-
Hollow clay brick Hlz B 12/1,2 brick A ^{e)}	$f_b \geq 12 \text{ N/mm}^2$	F_{Rd} [kN]	0,2	-	-	-
Vertically perforated clay brick Hlz 1,2-2DF brick F ^{e)}	$f_b \geq 8 \text{ N/mm}^2$	F_{Rd} [kN]	-	0,6	-	-
	$f_b \geq 10 \text{ N/mm}^2$	F_{Rd} [kN]	-	0,8	-	-
	$f_b \geq 12 \text{ N/mm}^2$	F_{Rd} [kN]	-	0,8	-	-
Vertically perforated clay brick Hlz 1,0-2DF brick G ^{e)}	$f_b \geq 8 \text{ N/mm}^2$	F_{Rd} [kN]	-	0,16	0,3	-
	$f_b \geq 10 \text{ N/mm}^2$	F_{Rd} [kN]	-	0,2	0,36	-
	$f_b \geq 12 \text{ N/mm}^2$	F_{Rd} [kN]	-	0,24	0,36	-
	$f_b \geq 20 \text{ N/mm}^2$	F_{Rd} [kN]	-	0,36	0,6	-
Vertically perforated clay brick VHlz 1,6-2DF brick H ^{e)}	$f_b \geq 28 \text{ N/mm}^2$	F_{Rd} [kN]	-	0,8	1,0	-
	$f_b \geq 50 \text{ N/mm}^2$	F_{Rd} [kN]	-	1,2	1,4	-
Vertically perforated clay brick Poroton T8 brick M ^{e)}	$f_b \geq 6 \text{ N/mm}^2$	F_{Rd} [kN]	-	0,3	0,6	-
Vertically perforated clay brick Hlz 1,0-9DF brick L ^{e)}	$f_b \geq 8 \text{ N/mm}^2$	F_{Rd} [kN]	-	0,48	0,6	-
	$f_b \geq 10 \text{ N/mm}^2$	F_{Rd} [kN]	-	0,6	0,6	-
	$f_b \geq 12 \text{ N/mm}^2$	F_{Rd} [kN]	-	0,6	0,8	-
	$f_b \geq 16 \text{ N/mm}^2$	F_{Rd} [kN]	-	0,8	1,2	-

Design resistance

Anchor size				HRD 8		HRD 10		
				h_{nom} =50mm	h_{nom} =50mm	h_{nom} =70mm	h_{nom} =90mm	
Hollow sand-lime brick KSL 12/1,4 O^{e)}	brick	$f_b \geq 12 \text{ N/mm}^2$	F_{Rd} [kN]	0,3	-	-	-	
Vertically perforated sand-lime brick KSL 1,6-2DF	brick P^{e)}	$f_b \geq 8 \text{ N/mm}^2$	F_{Rd} [kN]	-	0,6	-	-	
		$f_b \geq 10 \text{ N/mm}^2$	F_{Rd} [kN]	-	0,6	-	-	
		$f_b \geq 12 \text{ N/mm}^2$	F_{Rd} [kN]	-	0,8	-	-	
Vertically perforated sand-lime brick KSL 1,4-3DF	brick Q^{e)}	$f_b \geq 8 \text{ N/mm}^2$	F_{Rd} [kN]	-	-	0,8	-	
		$f_b \geq 10 \text{ N/mm}^2$	F_{Rd} [kN]	-	-	1,0	-	
		$f_b \geq 12 \text{ N/mm}^2$	F_{Rd} [kN]	-	-	1,2	-	
Vertically perforated sand-lime brick KSL R 1,6-16DF	brick R^{e)}	$f_b \geq 8 \text{ N/mm}^2$	F_{Rd} [kN]	-	0,36	0,48	-	
		$f_b \geq 10 \text{ N/mm}^2$	F_{Rd} [kN]	-	0,48	0,6	-	
		$f_b \geq 12 \text{ N/mm}^2$	F_{Rd} [kN]	-	0,6	0,8	-	
Lightweight hollow brick Hbl 2/0,8	brick S^{e)}	$f_b \geq 2 \text{ N/mm}^2$	F_{Rd} [kN]	0,12	-	-	-	
		$f_b \geq 2 \text{ N/mm}^2$	F_{Rd} [kN]	-	0,2	0,3	-	
		$f_b \geq 6 \text{ N/mm}^2$	F_{Rd} [kN]	-	0,48	0,8	-	
Ital. Hollow brick Mattone	brick E^{e)}	$f_b \geq 22 \text{ N/mm}^2$	F_{Rk} [kN]	0,6	-	-	-	
Ital. Hollow brick Poroton P700	brick N^{e)}	$f_b \geq 15 \text{ N/mm}^2$	F_{Rd} [kN]	-	-	0,24	-	
Ital. Hollow brick Doppio Uni	brick C+I^{e)}		F_{Rd} [kN]	0,36 (C)	-	0,6 (I)	-	
Span. Hollow brick Rojo hidrofugano	brick D^{e)}	$f_b \geq 40 \text{ N/mm}^2$	F_{Rd} [kN]	0,24	-	-	-	
Span. Hollow brick Ladrillo perforado	brick J^{e)}	$f_b \geq 26 \text{ N/mm}^2$	F_{Rd} [kN]	-	0,6	0,8	-	
Span. Hollow brick Clinker mediterraneo	brick K^{e)}	$f_b \geq 75 \text{ N/mm}^2$	F_{Rd} [kN]	-	-	0,6	-	
French Hollow brick Brique Creuse	brick B^{e)}	$f_b \geq 6 \text{ N/mm}^2$	F_{Rd} [kN]	0,20	-	-	-	
Autoclaved aerated concrete AAC EN 771-4		AAC 2	F_{Rd} [kN]	-	-	0,45	0,45	
		AAC 4	F_{Rd} [kN]	0,21	-	1,0	1,25	
		AAC 6	F_{Rd} [kN]	0,21	-	1,0	1,25	
			F_{Rd} [kN]		-	1,75 ^{d)}	2,25 ^{d)}	

Recommended loads ^{a)}

Anchor size				HRD 8	HRD 10		
				h_{nom} =50mm	h_{nom} =50mm	h_{nom} =70mm	h_{nom} =90mm
Concrete C 12/15	N_{rec} [kN]		0,8	1,2	2,4	-	
	V_{rec} [kN]		3,9 / 3,7 ^{b)}	6,1 / 5,8 ^{b)} / 6,1 ^{c)}		-	
Concrete C 16/20 –C 50/60	N_{rec} [kN]		1,2	1,8	3,4	-	
	V_{rec} [kN]		3,9 / 3,7 ^{b)}	6,1 / 5,8 ^{b)} / 6,1 ^{c)}		-	
Solid clay brick Mz 2,0 DIN V 105-100 / EN 771-1	$f_b \geq 20 \text{ N/mm}^2$	F_{rec} [kN]	0,42	0,85	f)	-	
				1,28 ^{d)}			
	$f_b \geq 10 \text{ N/mm}^2$	F_{rec} [kN]	0,34	0,57	f)	-	
				0,85 ^{d)}			
Solid sand-lime brick KS 2,0 DIN V 106 / EN 771-2	$f_b \geq 20 \text{ N/mm}^2$	F_{rec} [kN]	0,7	0,85	f)	-	
				1,28 ^{d)}			
	$f_b \geq 10 \text{ N/mm}^2$	F_{rec} [kN]	0,57	0,57	f)	-	
				0,85 ^{d)}			
Lightweight solid block Vbl 0,9 DIN V 18151-100 / EN 771-3	$f_b \geq 20 \text{ N/mm}^2$	F_{rec} [kN]	-	1,0	f)	-	
				1,71 ^{d)}			
	$f_b \geq 10 \text{ N/mm}^2$	F_{rec} [kN]		0,71			
	$f_b \geq 6 \text{ N/mm}^2$	F_{rec} [kN]	0,14	-	-	-	
Ital. solid brick Tufo	$f_b \geq n/a$	F_{rec} [kN]	0,4	-	-	-	
Hollow clay brick Hz B 12/1,2 A ^{e)}	brick $f_b \geq 12 \text{ N/mm}^2$	F_{rec} [kN]	0,14	-	-	-	
Vertically perforated clay brick Hz 1,2-2DF F ^{e)}	brick $f_b \geq 8 \text{ N/mm}^2$	F_{rec} [kN]	-	0,42	-	-	
	$f_b \geq 10 \text{ N/mm}^2$	F_{rec} [kN]	-	0,57	-	-	
	$f_b \geq 12 \text{ N/mm}^2$	F_{rec} [kN]	-	0,57	-	-	
Vertically perforated clay brick Hz 1,0-2DF G ^{e)}	brick $f_b \geq 8 \text{ N/mm}^2$	F_{rec} [kN]	-	0,11	0,21	-	
	$f_b \geq 10 \text{ N/mm}^2$	F_{rec} [kN]	-	0,14	0,25	-	
	$f_b \geq 12 \text{ N/mm}^2$	F_{rec} [kN]	-	0,17	0,25	-	
	$f_b \geq 20 \text{ N/mm}^2$	F_{rec} [kN]	-	0,25	0,42	-	
Vertically perforated clay brick VHz 1,6-2DF brick H ^{e)}	$f_b \geq 28 \text{ N/mm}^2$	F_{rec} [kN]	-	0,57	0,71	-	
	$f_b \geq 50 \text{ N/mm}^2$	F_{rec} [kN]	-	0,85	1,0	-	
Vertically perforated clay brick Poroton T8 M ^{e)}	brick $f_b \geq 6 \text{ N/mm}^2$	F_{rec} [kN]	-	0,21	0,42	-	
Vertically perforated clay brick Hz 1,0-9DF L ^{e)}	brick $f_b \geq 8 \text{ N/mm}^2$	F_{rec} [kN]	-	0,34	0,42	-	
	$f_b \geq 10 \text{ N/mm}^2$	F_{rec} [kN]	-	0,42	0,42	-	
	$f_b \geq 12 \text{ N/mm}^2$	F_{rec} [kN]	-	0,42	0,57	-	
	$f_b \geq 16 \text{ N/mm}^2$	F_{rec} [kN]	-	0,57	0,85	-	

Recommended loads ^{a)}

Anchor size			HRD 8	HRD 10		
			h_{nom} =50mm	h_{nom} =50mm	h_{nom} =70mm	h_{nom} =90mm
Hollow sand-lime brick KSL 12/1,4 brick O ^{e)}	$f_b \geq 12 \text{ N/mm}^2$	F_{rec} [kN]	0,21	-	-	-
Vertically perforated sand-lime brick KSL 1,6-2DF brick P ^{e)}	$f_b \geq 8 \text{ N/mm}^2$	F_{rec} [kN]	-	0,42	-	-
	$f_b \geq 10 \text{ N/mm}^2$	F_{rec} [kN]	-	0,42	-	-
	$f_b \geq 12 \text{ N/mm}^2$	F_{rec} [kN]	-	0,57	-	-
Vertically perforated sand-lime brick KSL 1,4-3DF brick Q ^{e)}	$f_b \geq 8 \text{ N/mm}^2$	F_{rec} [kN]	-	-	0,57	-
	$f_b \geq 10 \text{ N/mm}^2$	F_{rec} [kN]	-	-	0,71	-
	$f_b \geq 12 \text{ N/mm}^2$	F_{rec} [kN]	-	-	0,85	-
Vertically perforated sand-lime brick KSL R 1,6-16DF brick R ^{e)}	$f_b \geq 8 \text{ N/mm}^2$	F_{rec} [kN]	-	0,25	0,34	-
	$f_b \geq 10 \text{ N/mm}^2$	F_{rec} [kN]	-	0,34	0,42	-
	$f_b \geq 12 \text{ N/mm}^2$	F_{rec} [kN]	-	0,42	0,57	-
Lightweight hollow brick Hbl 2/0,8 brick S ^{e)}	$f_b \geq 2 \text{ N/mm}^2$	F_{rec} [kN]	0,09	-	-	-
Lightweight concrete hollow block Hbl 1,2-12DF brick T ^{e)}	$f_b \geq 2 \text{ N/mm}^2$	F_{rec} [kN]	-	0,14	0,21	-
	$f_b \geq 6 \text{ N/mm}^2$	F_{rec} [kN]	-	0,34	0,57	-
Ital. Hollow brick Mattone brick E ^{e)}	$f_b \geq 22 \text{ N/mm}^2$	F_{rec} [kN]	0,43	-	-	-
Ital. Hollow brick Poroton P700 brick N ^{e)}	$f_b \geq 15 \text{ N/mm}^2$	F_{rec} [kN]	-	-	0,17	-
Ital. Hollow brick Doppio Uni brick C+I ^{e)}	$f_b \geq 25 \text{ N/mm}^2$	F_{rec} [kN]	0,25 (C)	-	0,42 (I)	-
Span. Hollow brick Rojo hidrofugano brick D ^{e)}	$f_b \geq 40 \text{ N/mm}^2$	F_{rec} [kN]	0,17	-	-	-
Span. Hollow brick Ladrillo perforado brick J ^{e)}	$f_b \geq 26 \text{ N/mm}^2$	F_{rec} [kN]	-	0,42	0,57	-
Span. Hollow brick Clinker mediterraneo brick K ^{e)}	$f_b \geq 75 \text{ N/mm}^2$	F_{rec} [kN]	-	-	0,42	-
French Hollow brick Brique Creuse brick B ^{e)}	$f_b \geq 6 \text{ N/mm}^2$	F_{rec} [kN]	0,14	-	-	-
Autoclaved aerated concrete AAC EN 771-4	AAC 2	F_{rec} [kN]	-	-	0,32	0,32
	AAC 4	F_{rec} [kN]	0,15	-	0,71	0,89
	AAC 6	F_{rec} [kN]	0,15	-	0,71	0,89
		F_{rec} [kN]		-	1,25 ^{d)}	1,6 ^{d)}





- a) With overall partial safety factor for action $\gamma = 1,4$. The partial safety factors for action depend on the type of loading and shall be taken from national regulations.
- b) Values for hot-dip galvanized carbon steel
- c) Values for stainless steel
- d) Valid for edge distance $c \geq 150\text{mm}$, intermediate values can be interpolated
- e) Specification of hollow base material brick types see separate table below
- f) Data can be determined by job-site testing, data for $h_{nom} = 50\text{mm}$ can be applied.

Characteristic resistance for pull-out failure (plastic sleeve) for use in concrete

Anchor type		HRD 8	HRD 10	
Pull-out failure in <u>standard concrete slabs</u>				
Embedment depth	$h_{nom} \geq$ [mm]	50	50	70
Characteristic resistance	\geq C16/20 $N_{Rk,p}$ [kN]	3,0	4,5	8,5
	C12/15 $N_{Rk,p}$ [kN]	2,0	3,0	6,0
Partial safety factor	$\gamma_{Mc}^a)$	1,8		
Pull-out failure in <u>thin skins (weather resistant skins of external wall panels)</u>				
Embedment depth	$h_{nom} \geq$ [mm]	-	50	-
Characteristic resistance	$h = 40\text{mm}$ \geq C16/20 $N_{Rk,p}$ [kN]	-	3,5	-
	to 100mm C12/15 $N_{Rk,p}$ [kN]	-	2,5	-
Partial safety factor	$\gamma_{Mc}^a)$	1,8		
Pull-out failure in <u>precast prestressed hollow core slabs</u>				
Embedment depth	$h_{nom} \geq$ [mm]	-	50	-
Characteristic resistance	$d_b \geq 25\text{mm}$ \geq C35/45 $N_{Rk,p}$ [kN]	-	0,6	-
	$d_b \geq 30\text{mm}$ \geq C35/45 $N_{Rk,p}$ [kN]	-	1,5	-
	$d_b \geq 35\text{mm}$ \geq C35/45 $N_{Rk,p}$ [kN]	-	2,5	-
	$d_b \geq 40\text{mm}$ \geq C35/45 $N_{Rk,p}$ [kN]	-	3,5	-
Partial safety factor	$\gamma_{Mc}^a)$	1,8		

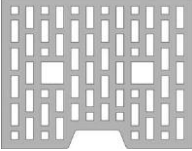
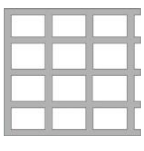
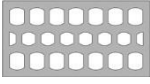
a) In absence of other national regulations

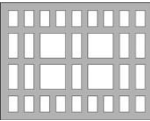
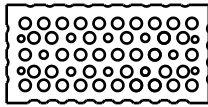
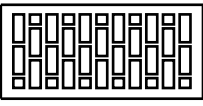
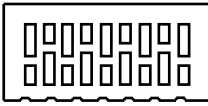
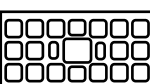
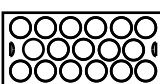
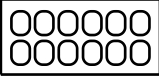
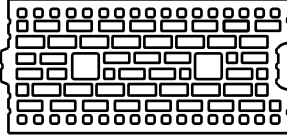
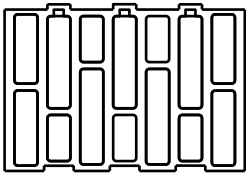
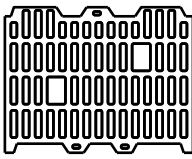
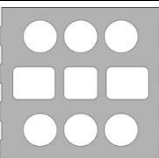
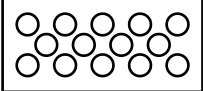
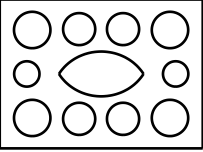
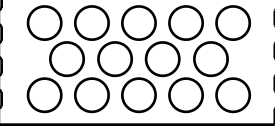
Specification of hollow base material brick types

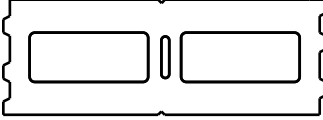
Specification	Picture / drilling method	Specification	Picture / drilling method
Hollow clay bricks according EN 771-1			
brick A Hlz B 12/1,2 LxWxH [mm]: 300x240x248 hmin [mm]: 240	 Rotary drilling	brick B Brique Creuse LxWxH [mm]: 210x198x... hmin [mm]: 210	 Rotary drilling
brick C Doppio Uni LxWxH [mm]: 230x120x100 hmin [mm]: 120	 Rotary drilling	brick D Rojo hidrofugano LxWxH [mm]: 240x115x50 hmin [mm]: 115	 Rotary drilling
brick E Mattone LxWxH [mm]: 240x180x100 hmin [mm]: 180	 Rotary drilling	brick F Hlz 1,2-2DF LxWxH [mm]: 240x115x113 hmin [mm]: 115	 Hammer drilling
brick G Hlz 1,0-2DF LxWxH [mm]: 240x115x113 hmin [mm]: 110	 Hammer drilling	brick H VHlz 1,6-2DF LxWxH [mm]: 240x115x113 hmin [mm]: 115	 Hammer drilling
brick I Doppio Uni LxWxH [mm]: 250x120x190 hmin [mm]: 120	 Rotary drilling	brick J Ladrillo perforado LxWxH [mm]: 240x110x100 hmin [mm]: 110	 Rotary drilling
brick K Clinker mediterraneo LxWxH [mm]: 240x113x50 hmin [mm]: 113	 Hammer drilling	brick L Hlz 1,0-9DF LxWxH [mm]: 372x175x238 hmin [mm]: 175	 Rotary drilling
brick M Poroton T8 LxWxH [mm]: 248x365x249 hmin [mm]: 365	 Rotary drilling	brick N Poroton P700 LxWxH [mm]: 225x300x190 hmin [mm]: 300	 Rotary drilling
Hollow sand-lime bricks according EN 771-2			
brick O KSL 12/1,4 LxWxH [mm]: 240x248x248 hmin [mm]: 240	 Hammer drilling	brick P KS L 1,6-2DF LxWxH [mm]: 240x115x113 hmin [mm]: 115	 Hammer drilling
brick Q KS L 1,4-3DF LxWxH [mm]: 240x175x113 hmin [mm]: 175	 Hammer drilling	brick R KS L R 1,6-16DF LxWxH [mm]: 480x240x248 hmin [mm]: 240	 Rotary drilling
Lightweight concrete hollow block according EN 771-3			
brick S Hbl 2/0,8 LxWxH [mm]: 497x240x248 hmin [mm]: 240	 Hammer drilling	brick T Hbl 1,2-12DF LxWxH [mm]: 497x175x238 hmin [mm]: 175	 Rotary drilling

Requirements for redundant fastening

The definition of redundant fastening according to Member States is given in the ETAG 020. In Absence of a definition by a Member State the following default values may be taken

Minimum number of fixing points	Minimum number of anchors per fixing point	Maximum design load of action N_{Sd} per fixing point ^{a)}
3	1	3 kN
4	1	4,5 kN

a) The value for maximum design load of actions per fastening point N_{Sd} is valid in general that means all fastening points are considered in the design of the redundant structural system.

Service temperature range

Hilti HRD frame anchors may be applied in the temperature range given below.

Temperature range	Base material temperature	Maximum long term base material temperature	Maximum short term base material temperature
Temperature range	-40 °C to +80 °C	+50 °C	+80 °C

Max short term base material temperature

Short-term elevated base material temperatures are those that occur over brief intervals, e.g. as a result of diurnal cycling.

Max long term base material temperature

Long-term elevated base material temperatures are roughly constant over significant periods of time.

Materials

Mechanical properties

Anchor size		HRD 8		HRD 10		
		Galv. steel	Stainless steel	Galv. steel	Hot-dip galvanised	Stainless steel
Nominal tensile strength f_{uk}	[N/mm ²]	600	580	600	600	630
Yield strength f_{yk}	[N/mm ²]	480	450	480	480	480
Stressed cross-section A_s	[mm ²]	22,9	22,9	35,3	33,7	35,3
Moment of resistance W	[mm ³]	15,5	15,5	29,5	27,6	29,5
Char. bending resistance $M_{Rk,s}^0$	[Nm]	11,1	10,8	21,3	19,9	22,3

Material quality

Part	Material	
Sleeve	Polyamide, colour red	
Screw	HRD-C, -H, -K, -P	Carbon steel, galvanised to min. 5 µm
	HRD-HF	Carbon steel, hot-dip galvanised to min. 65 µm
	HRD-CR2, -HR2, -KR2, -PR2	Stainless steel, corrosion class II: 1.4301 / 1.4567
	HRD-CR, -HR, -KR, -PR	Stainless steel, corrosion class III: 1.4362 / 1.4401 / 1.4404 / 1.4571

Anchor dimensions

Anchor size			HRD 8	HRD 10
Minimum thickness of fixture	$t_{\text{fix,min}}$	[mm]	0	0
Maximum thickness of fixture	$t_{\text{fix,max}}$	[mm]	90	260
Diameter of the sleeve	d_{nom}	[mm]	8	10
Minimum length of the sleeve	$l_{1,\text{min}}$	[mm]	60	60
Maximum length of the sleeve	$l_{1,\text{max}}$	[mm]	140	310
Diameter of plastic washer	d_{pw}	[mm]	-	17,5
Thickness of plastic washer	t_{pw}	[mm]	-	2
Diameter of the screw	d_{s}	[mm]	6	7
Minimum length of the screw	$l_{2,\text{min}}$	[mm]	65	65
Maximum length of the screw	$l_{2,\text{max}}$	[mm]	145	315
Head diameter of countersunk screw	d_{sc}	[mm]	11	14
Head diameter of hexhead screw	d_{sw}	[mm]	-	17,5

Anchor sleeve

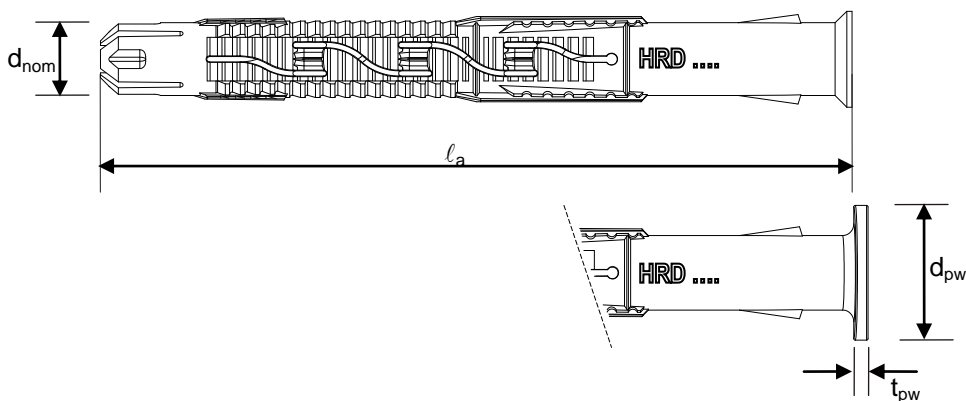

Special screw

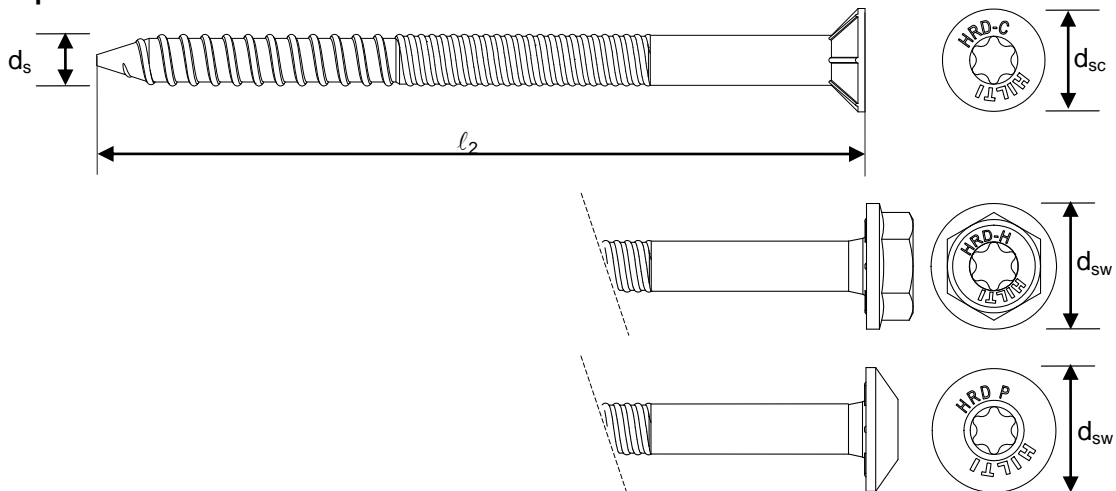

Setting

Installation equipment

Anchor size	
Rotary hammer	TE2 ... TE16
Other tools	hammer, screw driver

Setting instruction

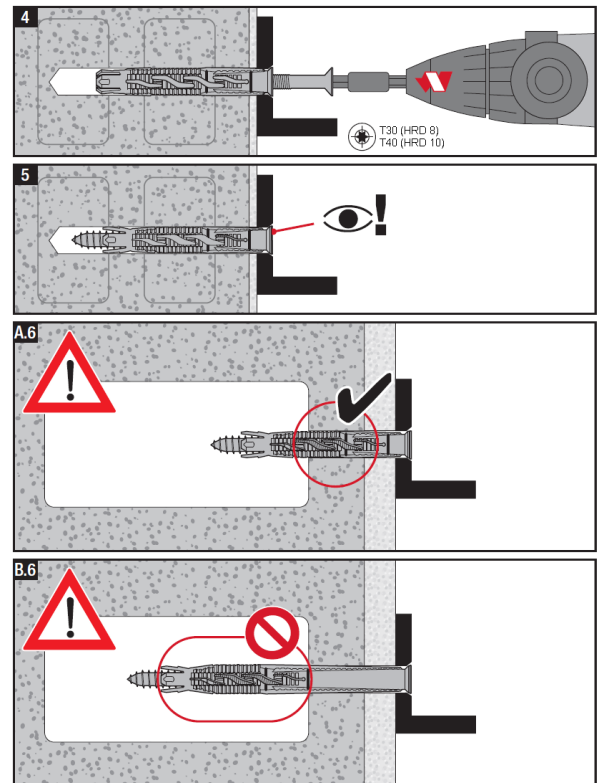
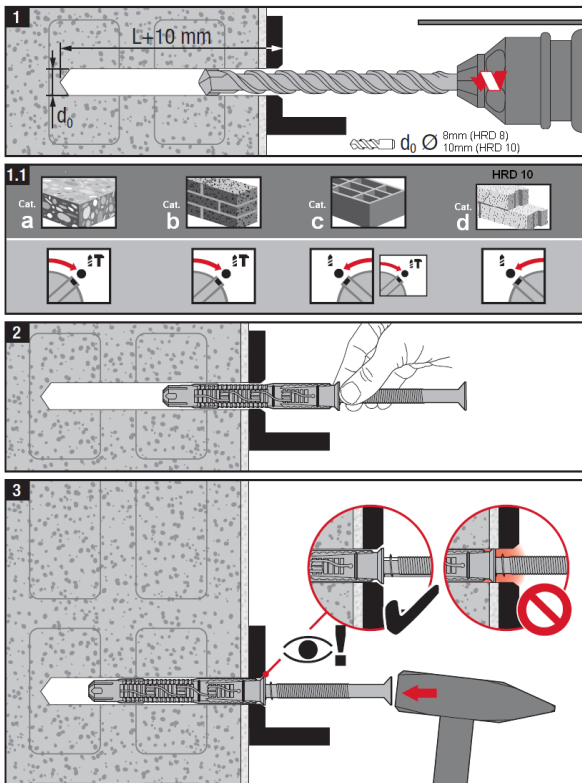

Additional preparation in case of application in precast prestressed hollow core slabs

After drilling follow the main instruction above

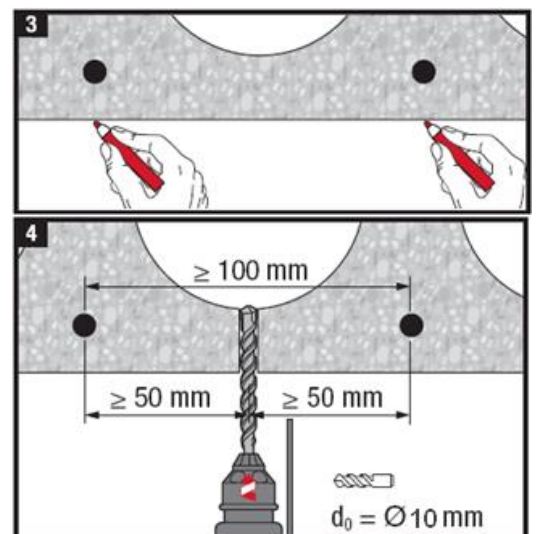
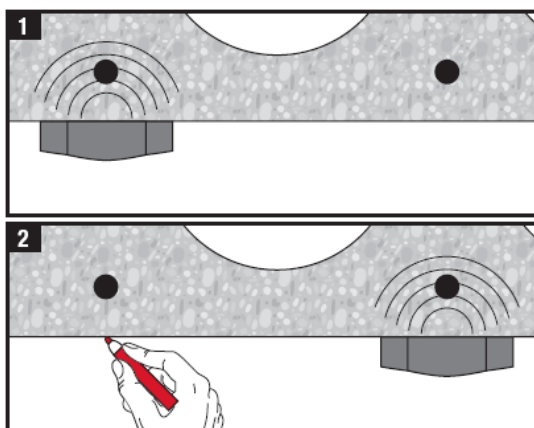

For detailed information on installation see instruction for use given with the package of the product.

Setting details: depth of drill hole h_1 and nominal anchorage depth h_{nom}

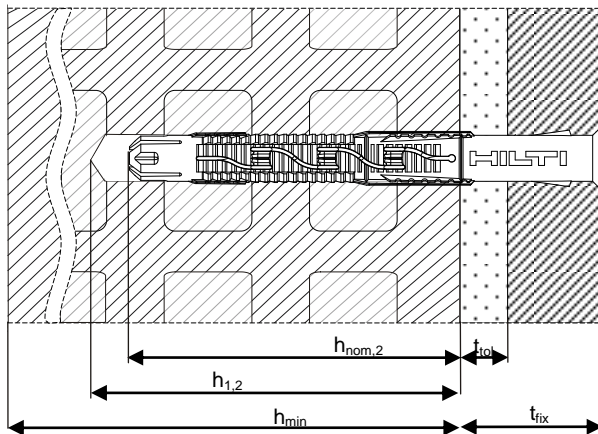
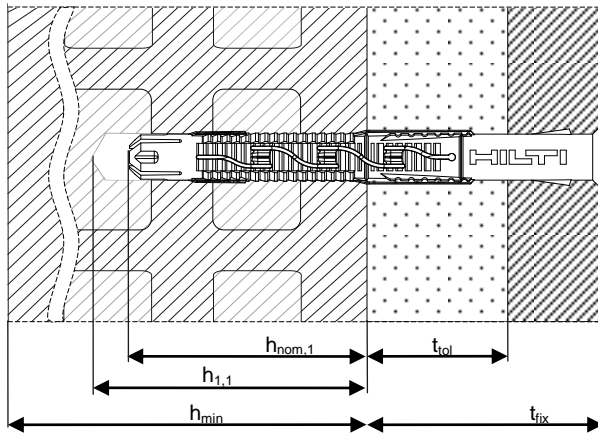

Application with $h_{nom,3} = 90\text{mm}$ analogue

Setting details HRD

			HRD 8	HRD 10
Drill hole diameter	d_o	[mm]	8	10
Cutting diameter of drill bit	$d_{cut} \leq$	[mm]	8,45	10,45
Depth of drilled hole to deepest point	$h_{1,1} \geq$	[mm]	60	60
	$h_{1,2} \geq$	[mm]	-	80
	$h_{1,3} \geq$	[mm]	-	100 ^{a)}
Overall plastic anchor embedment depth in base material	$h_{nom,1} \geq$	[mm]	50	50
	$h_{nom,2} \geq$	[mm]	-	70
	$h_{nom,3} \geq$	[mm]	-	90 ^{a)}
Diameter of clearance hole in the fixture	Countersunk screw	$d_f \leq$	[mm]	8,5
	Hexhead screw	$d_f \leq$	[mm]	-
Installation temperature		[°C]	-10 - +40	

^{a)} for use in AAC

Setting parameters

Anchor size				HRD 8		HRD 10	
				$h_{nom} = 50mm$	$h_{nom} = 50mm$	$h_{nom} = 70mm$	
Minimum base material thickness	Concrete	h_{min}	[mm]	100	100	120	
	Concrete thin skin	h_{min}	[mm]	-	40	-	
	Masonry (depending on brick type, see specification of brick types above)	h_{min}	[mm]	115 - 300			
Minimum spacing	Concrete \geq C16/20	s_{min}	[mm]	100	50		
		for $c \geq$	[mm]	50	100 ^{c)}		
	Concrete C12/15	s_{min}	[mm]	140	70		
		for $c \geq$	[mm]	70	140 ^{c)}		
	Masonry and AAC	a_{min}	[mm]	250	250		
	Masonry and AAC	s_{min1}	[mm]	200 (120 ^{d)})	100		
s_{min2}		[mm]	400 (240 ^{d)})	100			
Minimum edge distance	Concrete \geq C16/20	c_{min}	[mm]	50	50		
		for $s \geq$	[mm]	100	150 ^{c)}		
	Concrete C12/15	c_{min}	[mm]	70	70		
		for $s \geq$	[mm]	140	210 ^{c)}		
Masonry and AAC	c_{min}	[mm]	100 (60 ^{d)})	100			
Critical spacing in concrete ^{a)}	Concrete \geq C16/20	$s_{cr,N}$	[mm]	62	80	125	
	Concrete C12/15	$s_{cr,N}$	[mm]	68	90	135	
Critical edge distance in concrete ^{b)}	Concrete \geq C16/20	$c_{cr,N}$	[mm]	100	100		
	Concrete C12/15	$c_{cr,N}$	[mm]	140	140		

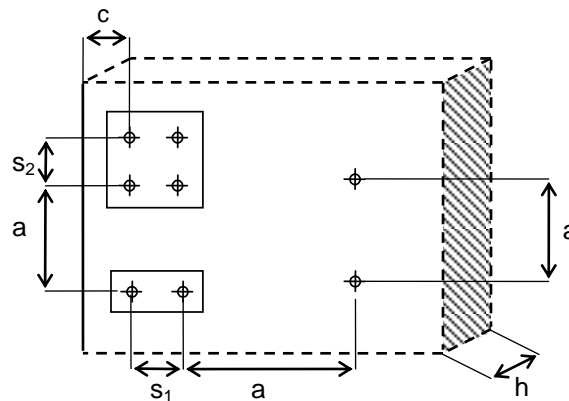

- a) For spacing larger than the critical spacing each anchor in a group can be considered in design.
- b) For edge distance smaller than critical edge distance the design loads have to be reduced.
- c) Linear interpolation allowed
- d) only for brick "Doppio Uni" and "Mattone"

Admissible anchor positions, minimum spacing and edge distance of anchors and distance between anchor groups in precast prestressed hollow core slabs

Anchor type		HRD 8	HRD 10
Overall plastic anchor embedment depth in the base material	$h_{nom} \geq$ [mm]	-	50
Bottom flange thickness	$d_b \geq$ [mm]	-	25
Core distance	$l_c \geq$ [mm]	-	100
Prestressing steel distance	$l_p \geq$ [mm]	-	100
Distance between anchor position and prestressing steel	$a_p \geq$ [mm]	-	50
Minimum edge distance	$c_{min} \geq$ [mm]	-	100
Minimum anchor spacing	$s_{min} \geq$ [mm]	-	100
Minimum distance between anchor groups	$a_{min} \geq$ [mm]	-	100

Schemes of distances and spacing

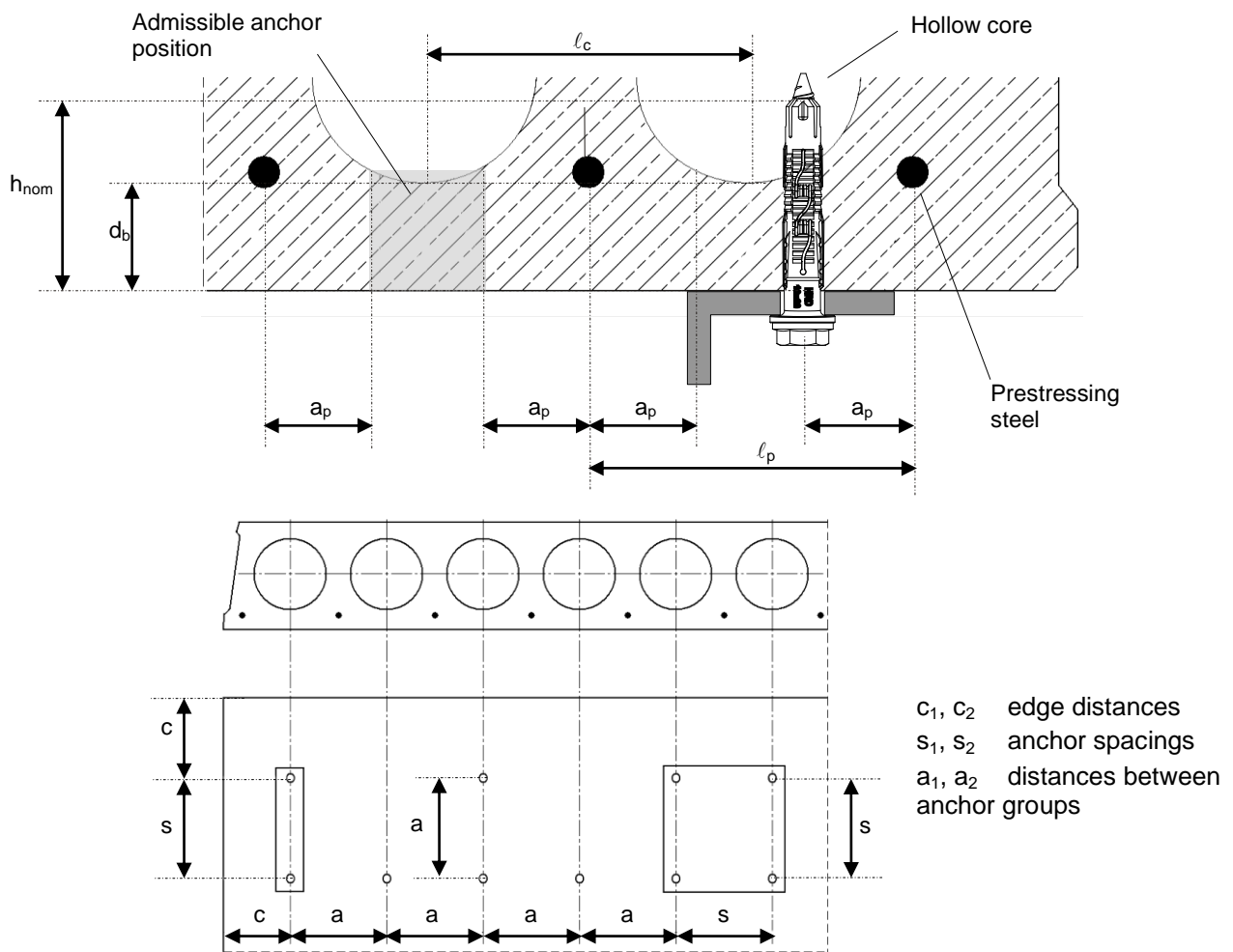

Design method

Design method according ETAG 020, Annex C. Design resistance according data given in ETA-07/0219, issue 2012-09-18.

- Valid for a group of two anchors
- Influence of edge distance

The design method is based on the following simplifications:

- Minimum base material thickness h_{min}
- All data for concrete C16/20 – C50/60
- No different loads are acting on individual anchors (no eccentricity)
- Shear without lever arm

The values are valid for a single anchor or a anchor group with spacing $< s_{cr,N}$ (for anchor groups with spacing $\geq s_{cr,N}$ each anchor can be considered as acting like a single anchor).

Tension loading in concrete

The design tensile resistance is the lower value of

- Steel resistance: $N_{Rd,s}$
- Concrete pull-out resistance: $N_{Rd,p}$
- Concrete cone resistance: $N_{Rd,c} = N_{Rd,p} \cdot (c/c_{cr,N})$

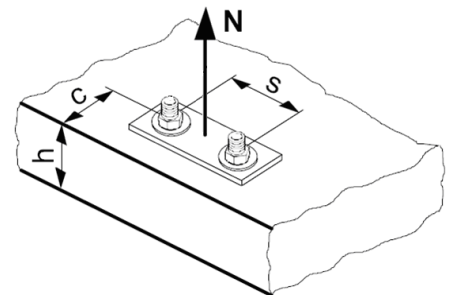

Basic design tensile resistance

Design steel resistance $N_{Rd,s}$

Anchor size		HRD 8	HRD 10	
		$h_{nom} = 50mm$	$h_{nom} = 50mm$	$h_{nom} \geq 70mm$
$N_{Rd,s}$	Carbon steel [kN]	7,3	11,7	11,7
	Stainless steel [kN]	6,8	11,6	11,6

Design pull-out resistance $N_{Rd,p}$

Design concrete cone $N_{Rd,c} = N_{Rd,p} \cdot (c/c_{cr,N})$

Anchor size		HRD 8	HRD 10	
		$h_{nom} = 50mm$	$h_{nom} = 50mm$	$h_{nom} \geq 70mm$
$N_{Rd,p}$	Carbon steel [kN]	1,7	2,5	4,7
	Stainless steel [kN]	1,7	2,5	4,7

Shear loading in concrete

The design shear resistance is the lower value of

- Steel resistance: $V_{Rd,s}$
- Concrete edge resistance: $V_{Rd,c} = V^0_{Rd,c} \cdot f_B \cdot f_c$

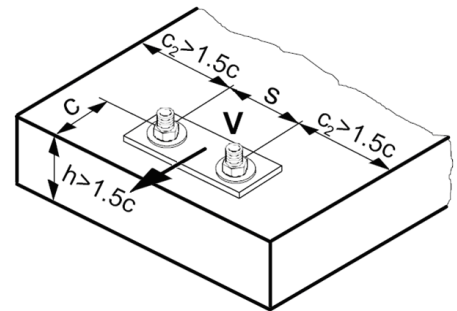

Basic design shear resistance

Design steel resistance $V_{Rd,s}$

Anchor size	HRD 8		HRD 10	
	$h_{nom} = 50mm$		$h_{nom} = 50mm$	$h_{nom} \geq 70mm$
$V_{Rd,s}$	Carbon steel [kN]		5,5	8,5
	Stainless steel [kN]		5,2	8,5

Design concrete edge resistance^{a)} $V_{Rd,c} = V^0_{Rd,c} \cdot f_B \cdot f_c$

Anchor type	HRD 8		HRD 10	
	$h_{nom} = 50mm$		$h_{nom} = 50mm$	$h_{nom} \geq 70mm$
$V^0_{Rd,c}$ [kN]	5,1	5,5	5,8	

a) For anchor groups only the anchors close to the edge must be considered

Influencing factors

Influence of concrete strength

Concrete strength designation (ENV 206)	C 16/20	C 20/25	C 25/30	C 30/37	C 35/45	C 40/50	C 45/55	C 50/60
$f_B = (f_{ck,cube}/25N/mm^2)^{1/2}$ a)	0,89	1	1,1	1,22	1,34	1,41	1,48	1,55

a) $f_{ck,cube}$ = concrete compressive strength, measured on cubes with 150 mm side length

Influence of edge distance for different base material thickness^{a)}

h [mm]	$f_c =$	c [mm]											
		50	60	70	80	90	100	120	140	160	180	200	220
h = 100 mm		0,35	0,46	0,57	0,65	0,73	0,82	0,98	1,14	1,31	1,47	1,63	1,80
h = 120 mm		0,35	0,46	0,59	0,72	0,80	0,89	1,07	1,25	1,43	1,61	1,79	1,97
h = 150 mm		0,35	0,46	0,59	0,72	0,85	1,00	1,20	1,40	1,60	1,80	2,00	2,20
h = 180 mm		0,35	0,46	0,59	0,72	0,85	1,00	1,31	1,53	1,75	1,97	2,19	2,41

a) The edge distance shall not be smaller than the minimum edge distance c_{min} .

The base material thickness shall not be smaller than the minimum base material thickness h_{min} .

Combined TENSION and SHEAR loading in masonry

The design resistance in masonry and AAC F_{Rd} (see basic loading data) shall be used in each load direction for single anchors and anchor groups.

HRV Frame anchor

	Anchor version	Benefits
	HRV-H 10x80	<ul style="list-style-type: none"> • Available in CS and HDG • Suitable for concrete and solid brick • Integrated plastic and steel washers
	HRV-H 10x100	
	HRV-HF 10x80	
	HRV-HF 10x100	

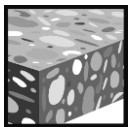

Concrete

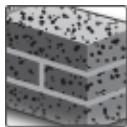

Solid brick

Basic loading data according Hilti technical data assessment

All data in this section applies to

- Correct setting (See setting instruction)
- No edge distance and spacing influence
- Non-cracked concrete C16/20 – C50/60, other base material as specified
- Minimum base material thickness
- Steel failure
- Shear without lever arm
- Anchors for single point application

Mean ultimate resistance

Anchor size		HRV 10	
		$h_{nom} = 70mm$	
Concrete C16/20 – C50/60	N_{Rum} [kN]	8,0	
	V_{Rum} [kN]	8,9	
Solid clay brick Mz 1,8 DIN 105-100 / EN 771-1 LxWxH [mm]: 240x115x113 hmin [mm]: 115	$f_b \geq 10 \text{ N/mm}^2$ F_{Rum} [kN]	2,65	
	$f_b \geq 20 \text{ N/mm}^2$ F_{Rum} [kN]	4,0	
Russian solid clay brick Density [kg/dm ³]: 1,9 LxWxH [mm]: 250x120x65 hmin [mm]: 120	$f_b \geq 10 \text{ N/mm}^2$ F_{Rum} [kN]	2,65	
	$f_b \geq 20 \text{ N/mm}^2$ F_{Rum} [kN]	4,0	

Characteristic resistance

Anchor size			HRV 10
			$h_{nom} = 70mm$
Concrete C16/20 – C50/60		N_{Rk} [kN]	6,0
		V_{Rk} [kN]	8,5
Solid clay brick Mz 1,8 DIN 105-100 / EN 771-1 LxWxH [mm]: 240x115x113 hmin [mm]: 115	$f_b \geq 10 \text{ N/mm}^2$	F_{Rk} [kN]	2,0
	$f_b \geq 20 \text{ N/mm}^2$	F_{Rk} [kN]	3,0
Russian solid clay brick Density [kg/dm ³]: 1,9 LxWxH [mm]: 250x120x65 hmin [mm]: 120	$f_b \geq 10 \text{ N/mm}^2$	F_{Rk} [kN]	2,0
	$f_b \geq 20 \text{ N/mm}^2$	F_{Rk} [kN]	3,0

Design resistance

Anchor size			HRV 10
			$h_{nom} = 70mm$
Concrete C16/20 – C50/60		N_{Rd} [kN]	3,3
		V_{Rd} [kN]	6,8
Solid clay brick Mz 1,8 DIN 105-100 / EN 771-1 LxWxH [mm]: 240x115x113 hmin [mm]: 115	$f_b \geq 10 \text{ N/mm}^2$	F_{Rd} [kN]	0,8
	$f_b \geq 20 \text{ N/mm}^2$	F_{Rd} [kN]	1,2
Russian solid clay brick Density [kg/dm ³]: 1,9 LxWxH [mm]: 250x120x65 hmin [mm]: 120	$f_b \geq 10 \text{ N/mm}^2$	F_{Rd} [kN]	0,8
	$f_b \geq 20 \text{ N/mm}^2$	F_{Rd} [kN]	1,2

Recommended loads ^{a)}

Anchor size			HRV 10
			$h_{nom} = 70mm$
Concrete C16/20 – C50/60		N_{rec} [kN]	2,4
		V_{rec} [kN]	4,8
Solid clay brick Mz 1,8 DIN 105-100 / EN 771-1 LxWxH [mm]: 240x115x113 hmin [mm]: 115	$f_b \geq 10 \text{ N/mm}^2$	F_{rec} [kN]	0,57
	$f_b \geq 20 \text{ N/mm}^2$	F_{rec} [kN]	0,86
Russian solid clay brick Density [kg/dm ³]: 1,9 LxWxH [mm]: 250x120x65 hmin [mm]: 120	$f_b \geq 10 \text{ N/mm}^2$	F_{rec} [kN]	0,57
	$f_b \geq 20 \text{ N/mm}^2$	F_{rec} [kN]	0,86

^{a)} With overall partial safety factor for action $\gamma = 1,4$. The partial safety factors for action depend on the type of loading and shall be taken from national regulations.

Service temperature range

Hilti HRV frame anchors may be applied in the temperature range given below.

Temperature range	Base material temperature	Maximum long term base material temperature	Maximum short term base material temperature
Temperature range	-40 °C to +80 °C	+50 °C	+80 °C

Max short term base material temperature

Short-term elevated base material temperatures are those that occur over brief intervals, e.g. as a result of diurnal cycling.

Max long term base material temperature

Long-term elevated base material temperatures are roughly constant over significant periods of time.

Materials

Mechanical properties

Anchor size		HRV 10	
		Galvanised steel	Hot-dip galvanised steel
Nominal tensile strength f_{uk}	[N/mm ²]	600	600
Yield strength f_{yk}	[N/mm ²]	480	480
Stressed cross-section A_s	tension [mm ²]	27,3	27,3
	shear [mm ²]	28,3	28,3
Moment of resistance W	[mm ³]	21,2	21,2
Char. bending resistance $M^0_{Rk,s}$	[Nm]	15,3	15,3

Material quality

Part	Material	
Sleeve	Polyamide, colour black	
Screw	HRV-H	Carbon steel, galvanised to min. 5 µm
	HRV-HF	Carbon steel, hot-dip galvanised to min. 45 µm

Masonry base materials

<p>Solid clay brick Mz 1,8 DIN 105-100 / EN 771-1 LxWxH [mm]: 240x115x113 hmin [mm]: 115</p> 	<p>Russian solid clay brick Density [kg/dm³]: 1,9 LxWxH [mm]: 250x120x65 hmin [mm]: 120</p> 
--	--

Anchor dimensions

Anchor size			HRV 10
Minimum thickness of fixture	$t_{\text{fix,min}}$	[mm]	0
Maximum thickness of fixture	$t_{\text{fix,max}}$	[mm]	30
Diameter of the sleeve	d_{nom}	[mm]	10
Minimum length of the sleeve	$l_{1,\text{min}}$	[mm]	80
Maximum length of the sleeve	$l_{1,\text{max}}$	[mm]	100
Diameter of plastic washer	d_{pw}	[mm]	17,8
Thickness of plastic washer	t_{pw}	[mm]	2,5
Diameter of the screw	d_{s}	[mm]	7
Minimum length of the screw	$l_{2,\text{min}}$	[mm]	75
Maximum length of the screw	$l_{2,\text{max}}$	[mm]	105
Head diameter of hexhead screw	d_{sw}	[mm]	17,5

Anchor sleeve

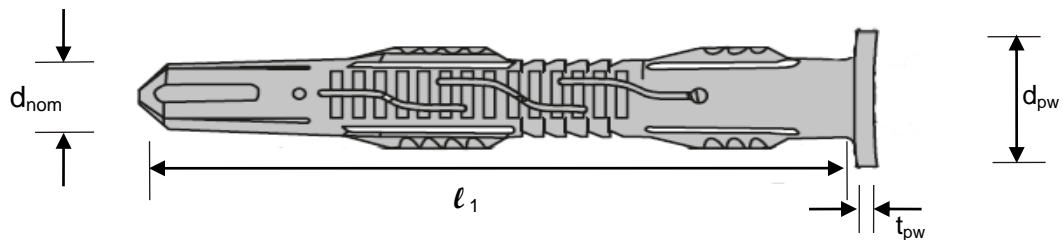

Special screw

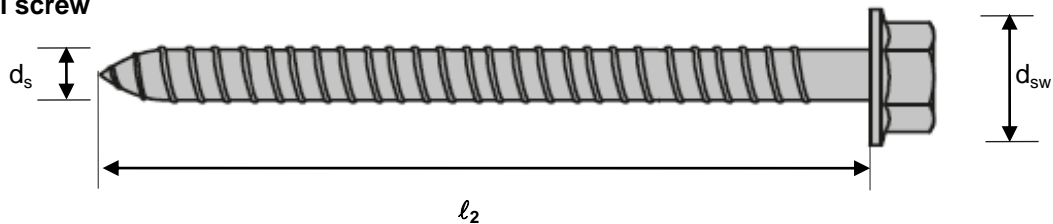

Setting

Installation equipment

Anchor size	
Rotary hammer	TE2 ... TE16
Other tools	hammer, screw driver

Setting instruction

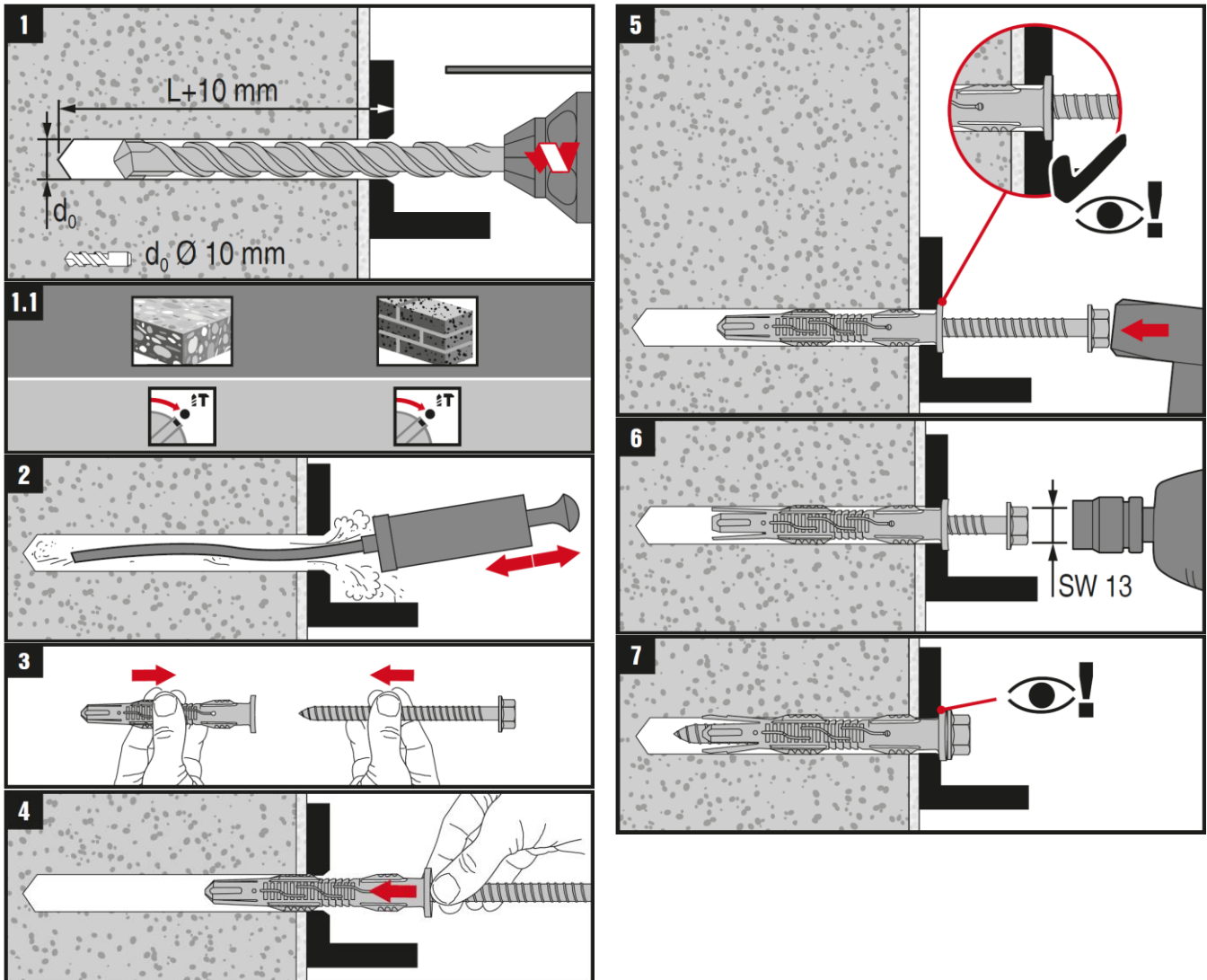

For detailed information on installation see instruction for use given with the package of the product.

Setting details: depth of drill hole h_1 and nominal anchorage depth h_{nom}

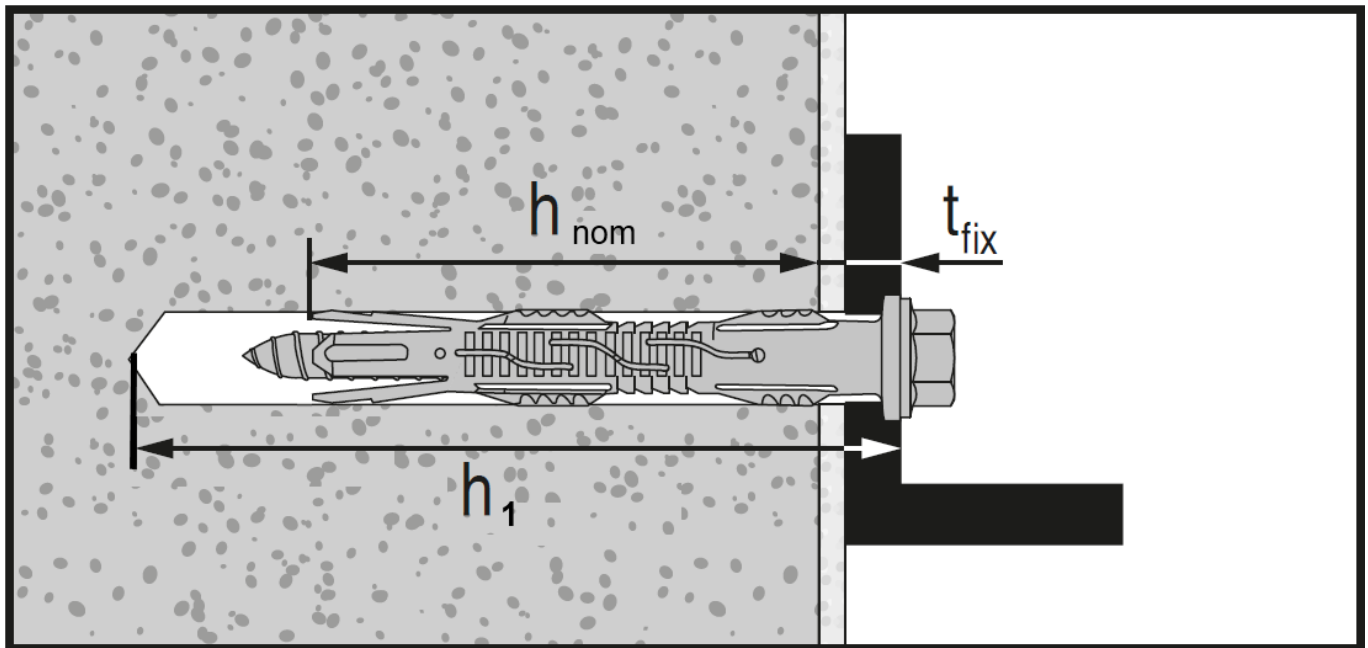

Setting details HRV

			HRV 10
Drill hole diameter	d_o	[mm]	10
Cutting diameter of drill bit	$d_{cut} \leq$	[mm]	10,45
Depth of drilled hole to deepest point	$h_1 \geq$	[mm]	80
Overall plastic anchor embedment depth in base material	$h_{nom} \geq$	[mm]	70
Diameter of clearance hole in the fixture	$d_f \leq$	[mm]	12
Installation temperature		[°C]	-10 - +40

Setting parameters

Anchor size				HRV 10
				$h_{nom} = 70\text{mm}$
Minimum base material thickness	$\geq \text{C16/20}$	h_{min}	[mm]	120
Minimum spacing	$\geq \text{C16/20}$	s_{min}	[mm]	50
		for $c \geq$	[mm]	100 ^{a)}
Minimum edge distance	$\geq \text{C16/20}$	c_{min}	[mm]	50
		for $s \geq$	[mm]	150 ^{a)}
Critical spacing for splitting failure	$\geq \text{C16/20}$	$s_{cr,sp}$	[mm]	200
Critical edge distance for splitting failure	$\geq \text{C16/20}$	$c_{cr,sp}$	[mm]	100
Critical spacing for concrete cone failure	$\geq \text{C16/20}$	$s_{cr,N}$	[mm]	210
Critical edge distance for concrete cone failure	$\geq \text{C16/20}$	$c_{cr,N}$	[mm]	105

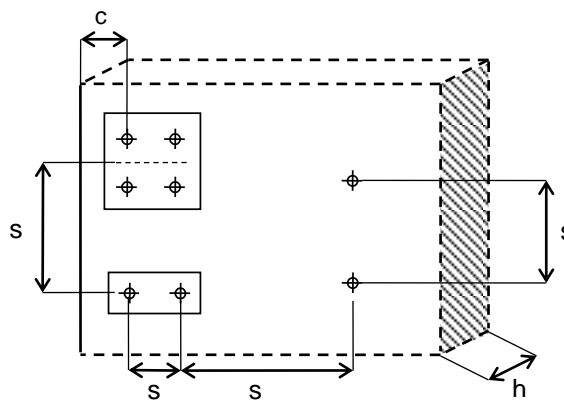

a) Linear interpolation allowed

GD 14 + GRS 12 Scaffolding anchor

Anchor version		Benefits
	GD 14 (anchor body)	<ul style="list-style-type: none"> Available in CS and HDG Integrated plastic and steel washers
	GRS 12 (screw)	

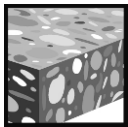

Concrete

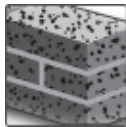

Solid brick

Basic loading data according Hilti technical data assessment

All data in this section applies to

- Correct setting (See setting instruction)
- Load data are only valid for the specified screw
- No edge distance and spacing influence
- Base material as specified in the table

Design resistance ^{a), b)}

Anchor size		GD 14					
		Screw type	GDS 12x90	GDS 12x120	GDS 12x160	GDS 12x190	GDS 12x230
Concrete C16/20 – C50/60	N _{Rd} [kN]	4,2					
	V _{Rd} [kN]	2,8	2,5	1,0	0,6	0,35	0,13
Solid clay brick Mz 12-2.0	N _{Rd} [kN]	1,9					
	V _{Rd} [kN]	1,0	1,0	1,0	0,6	0,35	0,13
Solid sand-lime brick KS 12-2.0	N _{Rd} [kN]	1,3					
	V _{Rd} [kN]	0,7	0,7	0,7	0,6	0,35	0,35

^{a)} With partial safety factor $\gamma = 1,8$ for concrete and $\gamma = 2,5$ for masonry (acc. ETAG 020).

^{b)} Shear load data are determined from the lower value of anchor load capacity in the base material and the serviceability load that ensures a maximum bending of the screw of 1/50 of its lever arm.

Recommended load ^{a), b)}

Anchor size		GD 14					
		GDS 12x90	GDS 12x120	GDS 12x160	GDS 12x190	GDS 12x230	GDS 12x350
Concrete C16/20 – C50/60	Screw type						
	N _{rec} [kN]	2,8					
	V _{rec} [kN]	1,8	1,7	0,65	0,4	0,23	0,09
Solid clay brick Mz 12-2.0	N _{rec} [kN]	1,3					
	V _{rec} [kN]	0,65	0,65	0,65	0,4	0,23	0,09
Solid sand-lime brick KS 12-2.0	N _{rec} [kN]	0,85					
	V _{rec} [kN]	0,5	0,5	0,5	0,4	0,23	0,09

a) With partial safety factor $\gamma = 1,5$ for the loading (acc. EN 12811-1).

b) Shear load data are determined from the lower value of anchor load capacity in the base material and the serviceability load that ensures a maximum bending of the screw of 1/50 of its lever arm.

Service temperature range

Hilti GD scaffolding anchormay be applied in the temperature range given below.

Temperature range	Base material temperature	Maximum long term base material temperature	Maximum short term base material temperature
Temperature range	-40 °C to +80 °C	+50 °C	+80 °C

Max short term base material temperature

Short-term elevated base material temperatures are those that occur over brief intervals, e.g. as a result of diurnal cycling.

Max long term base material temperature

Long-term elevated base material temperatures are roughly constant over significant periods of time.

Materials

Material quality

Part	Material
Plastic sleeve	Polyamide

Setting

Installation equipment

Anchor size	GD 14
Rotary hammer	TE 2 – TE 16
Other tools	–

Setting instruction

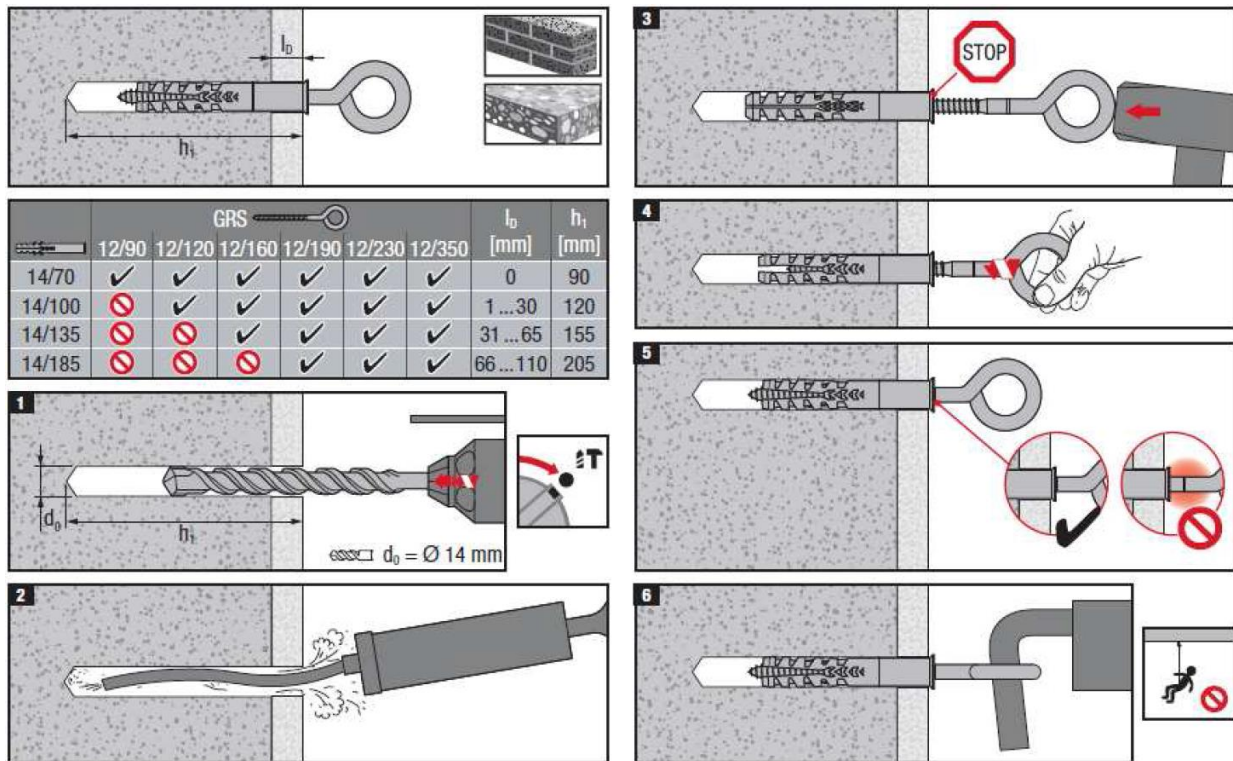

Use only for fixing scaffolds wall and floor applications. Not applicable for ceiling and façade applications.

For detailed information on installation see instruction for use given with the package of the product.

Setting details: depth of drill hole h_1 and effective anchorage depth h_{nom}

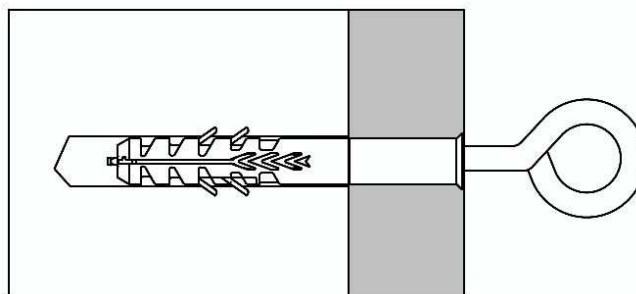

Setting details GD 14

			GD 14
Nominal diameter of drill bit	d_o	[mm]	14
Cutting diameter of drill bit	$d_{cut} \leq$	[mm]	14,5
Depth of drilled hole	$h_1 \geq$	[mm]	90
Effective anchorage depth	$h_{nom} \geq$	[mm]	70
Recommended length of screw in base material	l_d	[mm]	75
Installation temperature		[°C]	-10 to +40

HPS-1 Impact anchor

Anchor version	Benefits
 <p>HPS-1</p>	<ul style="list-style-type: none"> - impact anchor for light frames, battens and profiles on solid base materials - impact and temperature resistant - high quality plastic



Concrete

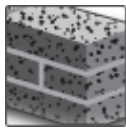

Solid brick

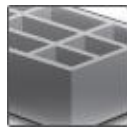

Hollow brick

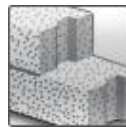
Autoclaved
aerated
concrete

Basic loading data (for a single anchor)

All data in this section applies to

- Correct setting (See setting instruction)
- No edge distance and spacing influence
- Base material as specified in the table
- Minimum base material thickness
- Loads shall be reduced if the temperature sustains above 40°C

Recommended loads ^{a)}

Anchor size HPS-1		4/0	5/0	5/5 – 5/15	6/0 – 6/25	6/30 – 6/40	8/0	8/10 – 8/40	8/60 – 8/100
Concrete ≥ C16/20	N_{Rd} [kN]	0,05	0,10	0,15	0,25	0,25	0,30	0,40	0,40
	V_{Rd} [kN]	0,15	0,30	0,35	0,55	0,35	0,50	0,90	0,50
Engineering brick, 12 hole, class B	N_{Rd} [kN]	0,05	0,10	0,15	0,25	0,25	0,30	0,40	0,40
	V_{Rd} [kN]	0,15	0,30	0,35	0,55	0,35	0,50	0,90	0,50
Perforated brick, 3 hole cammon	N_{Rd} [kN]	0,05	0,10	0,15	0,20	0,20	0,25	0,30	0,30
	V_{Rd} [kN]	0,15	0,30	0,35	0,55	0,35	0,50	0,90	0,55
Thermalite block, 7 N lightweight	N_{Rd} [kN]	-	-	0,08	0,15	0,15	0,20	0,25	0,25
	V_{Rd} [kN]	-	-	0,15	0,25	0,15	0,40	0,40	0,25
Thermalite block ½ N lightweight	N_{Rd} [kN]	-	-	0,05	0,08	0,08	-	0,12	0,12
	V_{Rd} [kN]	-	-	0,10	0,15	0,10	-	0,25	0,15
Autoclaved aerated concrete AAC 4, AAC 6	N_{Rd} [kN]	-	-	0,08	0,10	0,10	-	0,15	0,15
	V_{Rd} [kN]	-	-	0,10	0,12	0,10	-	0,30	0,20
Extruded brick, Boral 10	N_{Rd} [kN]	0,05	0,10	0,15	0,20	0,20	0,25	0,35	0,35
	V_{Rd} [kN]	0,15	0,25	0,30	0,40	0,25	0,50	0,90	0,55

a) With overall global safety factor $\gamma = 5$ to the characteristic loads and a partial safety factor of $\gamma = 1,4$ to the design values.

Service temperature range

Hilti HPS impact anchor may be applied in the temperature range given below.

Temperature range	Base material temperature	Maximum long term base material temperature	Maximum short term base material temperature
Temperature range	-40 °C to +80 °C	+50 °C	+80 °C

Max short term base material temperature

Short-term elevated base material temperatures are those that occur over brief intervals, e.g. as a result of diurnal cycling.

Max long term base material temperature

Long-term elevated base material temperatures are roughly constant over significant periods of time.

Materials

Material quality

Part	Material
Plastic sleeve	Polyamide 6.6
Screw	Carbon steel, galvanised to 5 µm or Stainless steel, grade A2 or Stainless steel, grade A2, copper-plated

Setting

Installation equipment

Anchor size	HPS-1 4	HPS-1 5	HPS-1 6	HPS-1 8
Rotary hammer	TE2 – TE16			
Other tools	Screwdriver			

Setting instruction

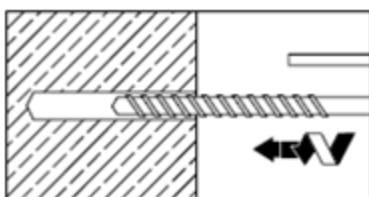

Drill hole with drill bit

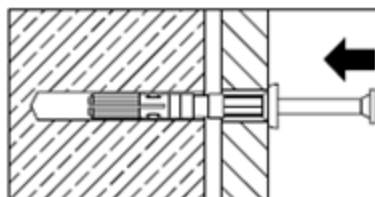

Install anchor.

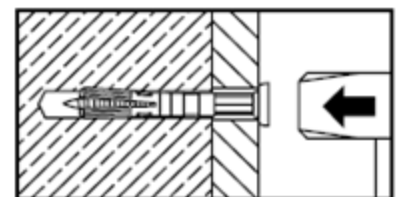

Hammer in anchor.

Setting details: depth of drill hole h_1 and effective anchorage depth h_{ef}

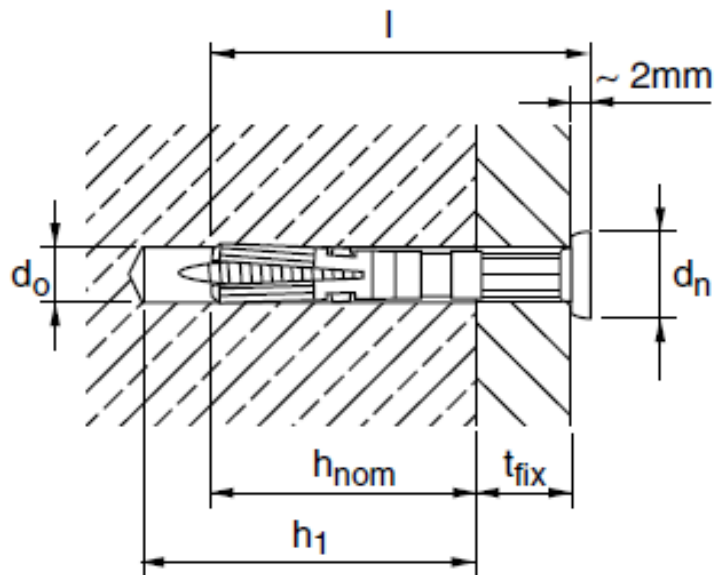

Setting details HPS-1

Anchor size		HPS-1 4	HPS-1 5	HPS-1 6	HPS-1 8
Nominal diameter of drill bit	d_o [mm]	4	5	6	8
Cutting diameter of drill bit	$d_{cut} \leq$ [mm]	4,35	5,35	6,4	8,45
Depth of drill hole	$h_1 \geq$ [mm]	25	30	40	50
Effective anchorage depth	h_{nom} [mm]	20	20	25	30
Anchor length	l [mm]	21,5	22 - 37	27 - 67	28,5 - 132,5
Max fixture thickness	t_{fix} [mm]	2	15	40	100
Installation temperature	[°C]	-10 to +40			

Base material thickness, anchor spacing and edge distance

Anchor size		HPS-1 4/	HPS-1 5/	HPS-1 6/	HPS-1 8/
Spacing	s [mm]	20	25	30	35
Edge distance	c [mm]	20	25	30	35

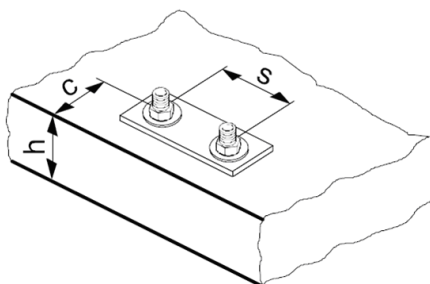

HHD-S Cavity anchor

Anchor version	Benefits
 HHD-S	<ul style="list-style-type: none"> - metal undercut anchor with metric screw, esp. for drywall - metal to metal fastening - reliable undercut



Drywall

Basic loading data (for a single anchor)

All data in this section applies to

- Correct setting (See setting instruction)
- No edge distance and spacing influence
- Base material as specified in the table
- Borehole drilling without hammering

Recommended loads ^{a)}

Anchor size		M4	M5	M6	M8
Hollow brick web thickness 20mm	N_{rec} [kN]	0,1	-	-	-
	V_{rec} [kN]	0,3	-	-	-
Gypsum board Thickness 10mm	N_{rec} [kN]	0,2	0,2	0,2	0,2
	V_{rec} [kN]	0,5	0,5	0,5	0,5
Gypsum board Thickness 12,5mm	N_{rec} [kN]	0,2	0,2	0,2	0,2
	V_{rec} [kN]	0,5	0,5	0,5	0,5
Gypsum board Thickness 2x12,5mm	N_{rec} [kN]	-	0,4	0,3	0,4
	V_{rec} [kN]	-	1	0,9	1
Fibre reinforced gypsum board Thickness 10mm	N_{rec} [kN]	0,2	0,3	0,25	0,4
	V_{rec} [kN]	0,5	0,6	0,8	0,9
Fibre reinforced gypsum board Thickness 12,5mm	N_{rec} [kN]	0,3	0,5	0,3	0,6
	V_{rec} [kN]	0,6	1	1	1,2
Fibre reinforced gypsum board Thickness 2x12,5mm	N_{rec} [kN]	-	0,9	0,8	0,9
	V_{rec} [kN]	-	1,1	1,8	1,7

a) With overall global safety factor $\gamma = 3$ to the characteristic loads and a partial safety factor of $\gamma = 1,4$ to the design values.

Materials

Material quality

Part	Material
Sleeve	Carbon steel, galvanised
Screw	Carbon steel, galvanised

Setting

Installation equipment

Anchor size	
Rotary hammer	TE2... TE16
Other tools	Screwdriver, HHD-SZ2 expansion tool

Setting instruction

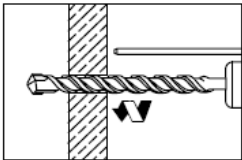

Drill hole with drill bit.

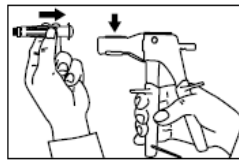

Put anchor into setting tool.

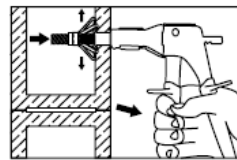

Install anchor with setting tool.

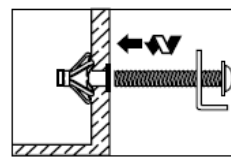

Remove screw from anchor and screw in gain with part being fastened attached.

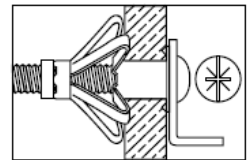

Setting details:

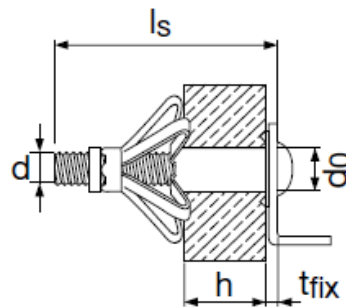

Setting details HHD-S

Anchor version			M4/4	M4/6	M4/12	M4/19	M5/8	M5/12	M5/25
Nominal diameter of drill bit	d_o	[mm]	8	8	8	8	10	10	10
Anchor length	l	[mm]	20	32	38	45	38	52	65
Anchor neck length	h	[mm]	4	6	12,5	19	8	12,5	25
Screw length	$l_s \geq$	[mm]	25	39	45	52	45	58	71
Screw diameter	d		M4	M4	M4	M4	M5	M5	M5
Panel thickness	$h_{min,max}$	[mm]	3 - 4	6 - 7	10 - 13	18 - 20	6 - 8	11 - 13	23 - 25
Max. fixable thickness for pre-setting	t_{fix}	[mm]	15	25	25	25	25	30	30

Anchor version			M6/9	M6/12	M6/24	M6/40	M8/12	M8/24	M8/40
Nominal diameter of drill bit	d_o	[mm]	12	12	12	12	12	12	12
Anchor length	l	[mm]	38	52	65	80	54	66	83
Anchor neck length	h	[mm]	9	12,5	25	40	12,5	25	40
Screw length	$l_s \geq$	[mm]	45	58	71	88	60	72	90
Screw diameter	d		M6	M6	M6	M6	M8	M8	M8
Panel thickness	$h_{min,max}$	[mm]	7 - 9	11 - 13	23 - 25	38 - 40	11 - 13	23 - 25	38 - 40
Max. fixable thickness for pre-setting	t_{fix}	[mm]	20	30	30	30	30	30	35

HCA Coil anchor

Anchor version	Benefits
 <p>HCA 5/8"</p>	<ul style="list-style-type: none"> - re-usable up to 140 times - high load capacity - big washer: \varnothing 34 mm - for temporary external applications

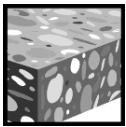

Concrete



Tensile zone

DIBt
Approval
Reusability

Approvals / certificates

Description	Authority / Laboratory	No. / date of issue
DIBt approval (Reusability)	DIBt, Berlin	Z-21.8-2027 / 2014-05-14

Basic loading data for temporary application

All data in this section applies to

- Correct setting (See setting instruction)
- No edge distance and spacing influence
- Base material as specified in the table

Basic loading data for temporary application in standard and fresh concrete < 28 days old, $f_{ck,cube} \geq 10 \text{ N/mm}^2$:

All data in this section applies to the following conditions:

- Strength class, $f_{ck,cube} \geq 10 \text{ N/mm}^2$
- Only temporary use
- Screw is reusable, before each usage it must be checked according Hilti instruction for use with the suited tube Hilti HRG
- Design resistance are valid for single anchor only
- Design resistance are valid for all load direction and valid for both cracked and non-cracked concrete
- Minimum base material thickness
- No edge distance and spacing influence

Design resistance for all directions in cracked in non-cracked concrete

Anchor			HCA 5/8" x 90	HCA 5/8" x 130
Length in concrete	$h_{nom} \geq$	[mm]	80	115
Design resistance for concrete strength $\geq 10 \text{ N/mm}^2$	$F_{Rd}^{1)}$	[kN]	4	12
Design resistance for concrete strength $\geq 15 \text{ N/mm}^2$	$F_{Rd}^{1)}$	[kN]	5	15
Design resistance for concrete strength $\geq 20 \text{ N/mm}^2$	$F_{Rd}^{1)}$	[kN]	6	18

Materials

Material quality

Part	Material
Anchor HCA 5/8"	Steel; galvanized; $f_{uk} \geq 850 \text{ N/mm}^2$
Coil HCT	Steel; galvanized; $350 \text{ N/mm}^2 \leq f_{uk} \leq 800 \text{ N/mm}^2$

Anchor dimensions

Dimensions and anchor head marks

Anchor			HCA 5/8" x 90	HCA 5/8" x 130
Length in concrete	$h_{nom} \geq$	[mm]	80	115
Anchor length	l	[mm]	90	125
Length of thread	l_s	[mm]	51	
Outer diameter	d_t	[mm]	15,8	
Core diameter	d_k	[mm]	13,1	
Marking for correct installation	h_s	[mm]	20	
Cross section	A_s	[mm ²]	196,1	

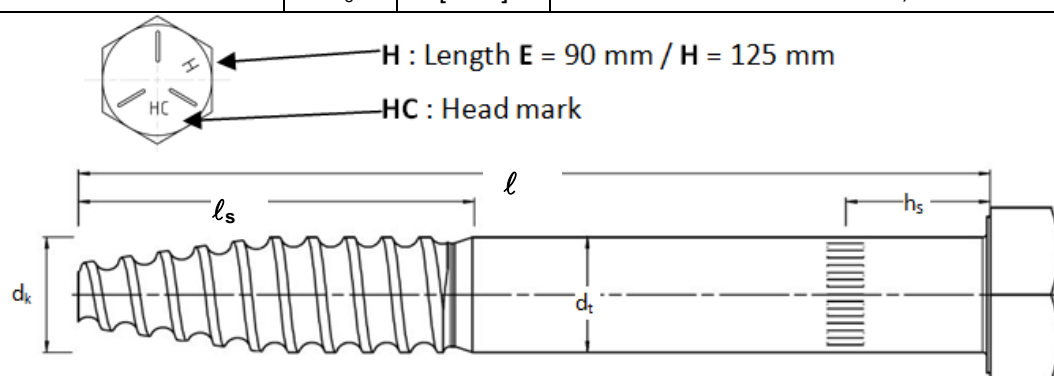

Coil dimensions

Coil			HCT
Length of Coil	ℓ	[mm]	29,3
Height Coil	h	[mm]	15,6

Tube specification

Tube			HRG 16
Inner tube diameter	\varnothing_i	[mm]	15,1
Outer tube diameter	\varnothing_e	[mm]	20,0
Tube length	L_t	[mm]	30,0

Setting

Installation equipment

Rotary hammer	TE2... TE80
Other tools	hammer, torque wrench, blow out pump

Setting details

Anchor			HCA 5/8" x 90	HCA 5/8" x 130
Length in concrete	$h_{nom} \geq$	[mm]	80	115
Nominal diameter of drill bit	d_0	[mm]	16	
Cutting diameter of drill bit	$d_{cut} \leq$	[mm]	16,5	
Diameter of clearance hole in the fixture	d_f	[mm]	18	
Wrench size (H-type)	SW	[mm]	24	
Thickness of fixture	t_{fix}	[mm]	0 .. 10	
Depth of drill hole	$h_1 \geq$	[mm]	95 - t_{fix}	135 - t_{fix}
Torque moment	T_{min}	[Nm]	180	

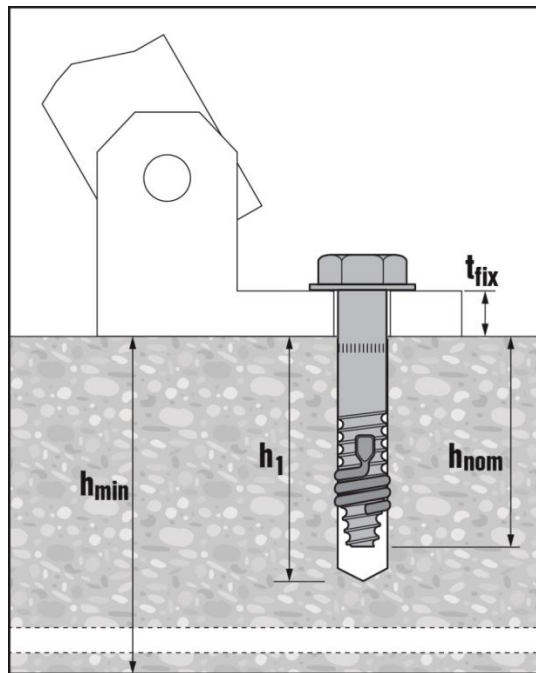

Setting instruction

HCA	$\varnothing d_0$ [mm]	t_{fix} [mm]	h_1 [mm]	d_f [mm]
16 x 90	16	0...10	$95 - t_{fix}$	18
16 x 130		0...10	$135 - t_{fix}$	

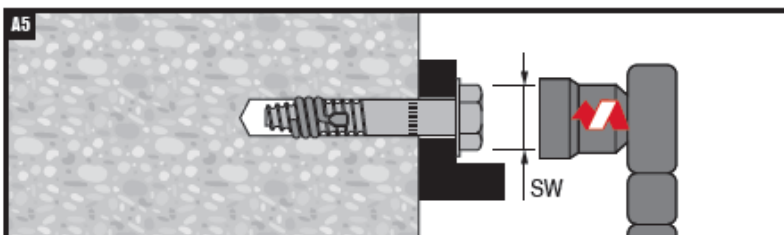
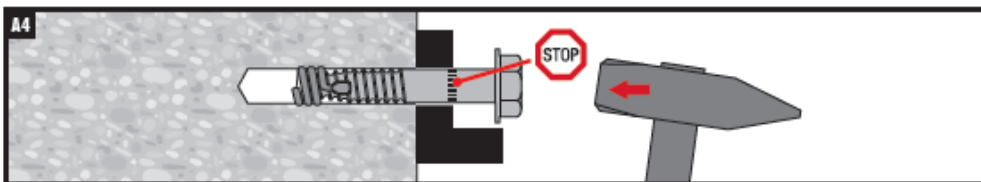
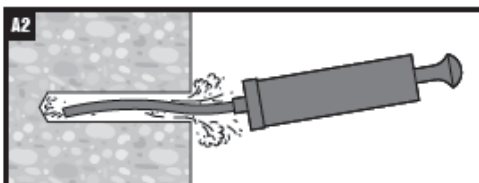
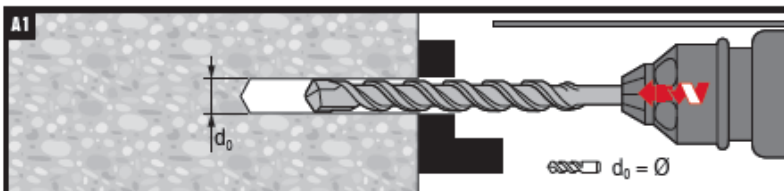

HCA [mm]	SW [mm]	t_{fix} [mm]	T_{min} [Nm]
$\varnothing 16$	24	10	180

Setting instruction for re-use in temporary use

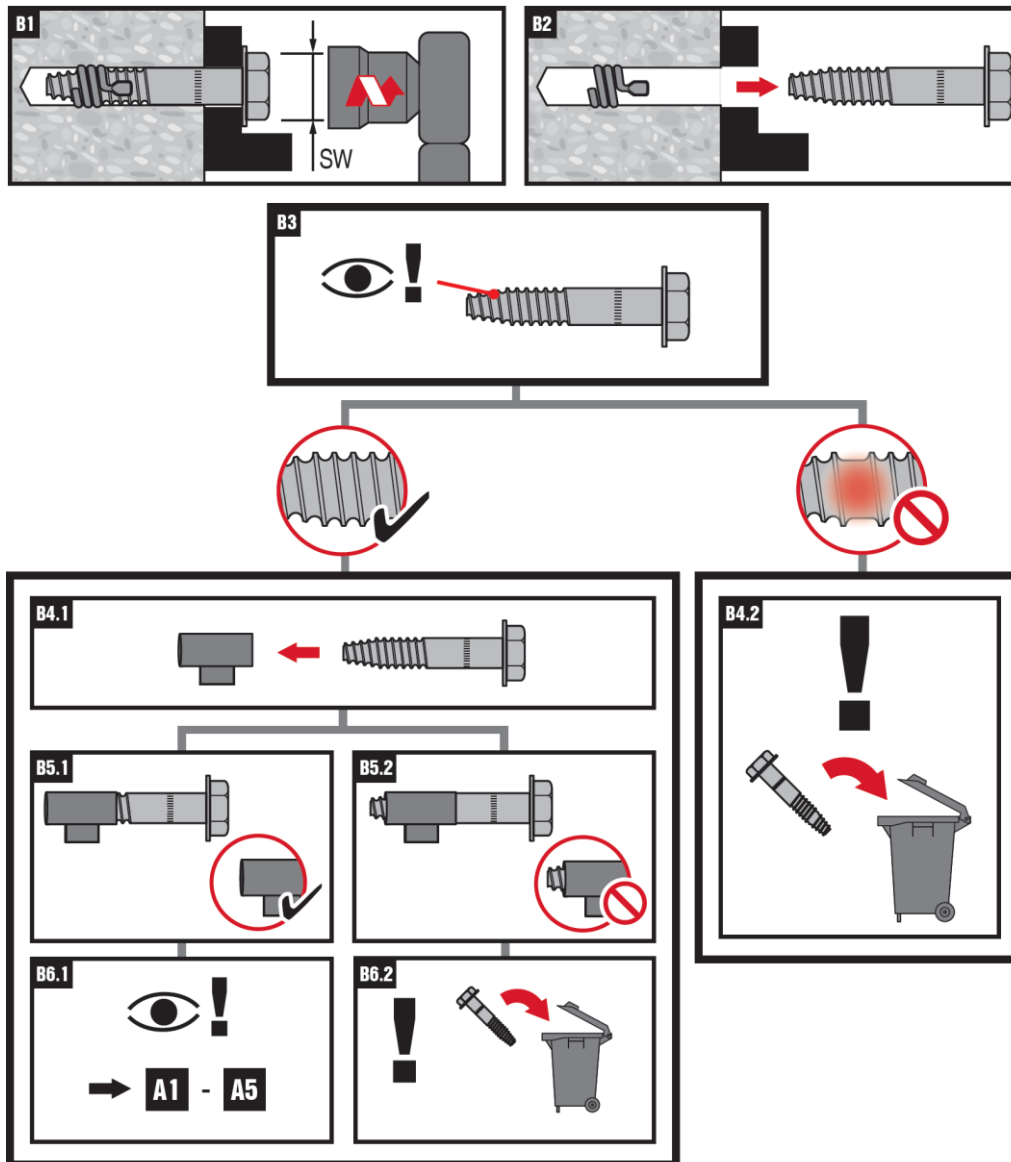

Before re-use of the coil anchor HCA 5/8" the wear shell be proven with the tube HRG 16:
 - the anchor is not visible on the back side of the tube
 - the anchor thread shell not damaged

Setting parameters

Minimum thickness of concrete member, minimum edge distance and spacing

Anchor			HCA 5/8" x 90	HCA 5/8" x 130
Length in concrete	$h_{nom} \geq$	[mm]	80	115
Minimum thickness of concrete member	h_{min}	[mm]	200	200
Minimum spacing	s_{min}	[mm]	125	550
Minimum edge distance (load direction 1)	$c_{1,min}$	[mm]	150	350
Minimum edge distance (load direction 2)	$c_{2,min}$	[mm]	200	500

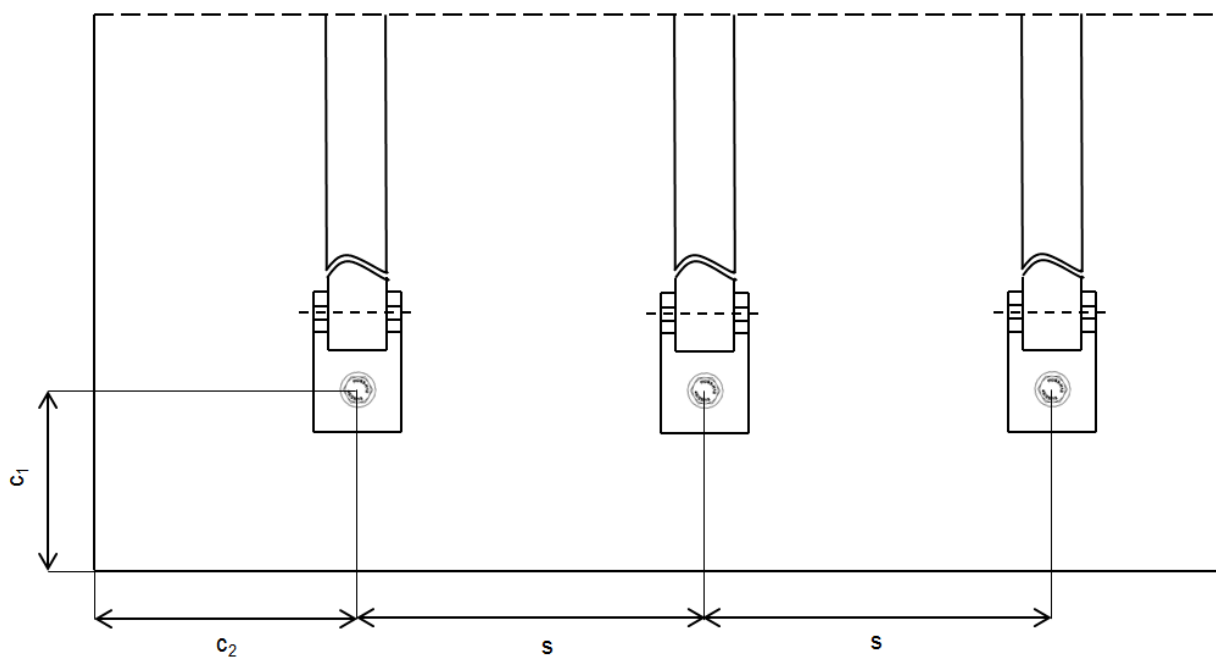

HSP / HFP Drywall plug

	Anchor version	Benefits
	HSP	<ul style="list-style-type: none"> - for light fastenings on drywall panel - self-cutting - quick setting
	HFP	



Drywall

Basic loading data (for a single anchor)

All data in this section applies to

- Correct setting (See setting instruction)
- No edge distance and spacing influence
- Base material as specified in the table

Recommended loads

Anchor size		HSP	HFP
Gypsum board Thickness 12,5 mm	N_{rec} [kN]	0,07	0,07
	V_{rec} [kN]	0,18	0,18
Gypsum board Thickness 2x12,5 mm	N_{rec} [kN]	0,1	-
	V_{rec} [kN]	0,27	-
Gypsum panel Thickness 100 mm ^{a)}	N_{rec} [kN]	0,09	-
	V_{rec} [kN]	0,25	-

a) Pre-drilling with 6mm diameter drill bit

Materials

Material quality

Part	Material
HFP	Polyamide, fibre reinforced
HSP	Zinc die-casting
Screw	Carbon steel, galvanised to min. 5µm

Setting

Installation equipment

Anchor size	
Rotary hammer	-
Other tools	Screwdriver with D-B PH2 HSP/HFP duo-bit

Setting instruction

HFP:

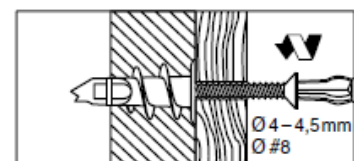
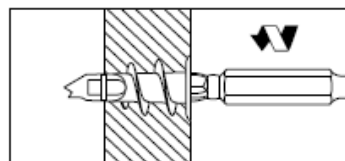
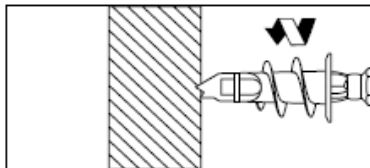

Drive in the plug.

Fasten part and drive in screw.

HSP:

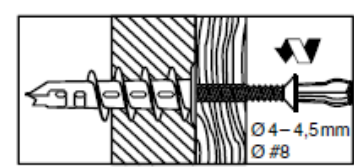
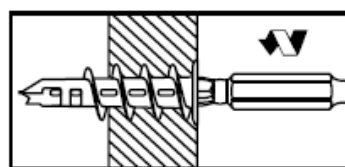
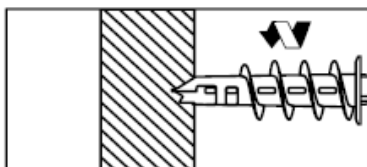

Drive in the plug.

Fasten part and drive in screw.

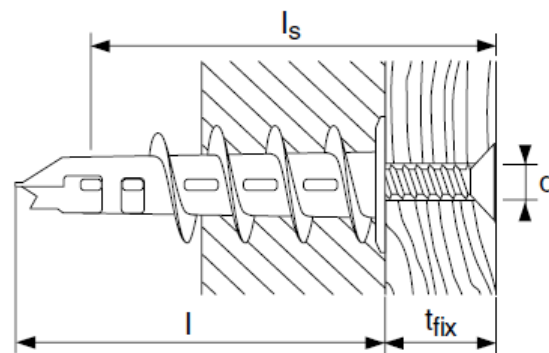

Setting details:



Setting details HSP / HFP

Anchor version			HSP	HFP
Max fixture thickness	t_{fix}	[mm]	15	10
Anchor length	l	[mm]	39	29
Screw length	l	[mm]	15 + t_{fix}	
Screw diameter	d	[mm]	4,5	4,5

HA 8 Ring / hook anchor

Anchor version		Benefits
	HA 8 R1	- 8mm anchor for concrete ceilings - hand-setting - follow-up expansion
	HA 8 H1	



Concrete



Tensile zone



Redundant fastening



Fire resistance

a) Redundant fastening only

Approvals / certificates

Description	Authority / Laboratory	No. / date of issue
Fire test report	IBMB, Braunschweig	UB 3245/1817-5 / 1997-12-12
Assessment report (fire)	warringtonfire	WF 327804/A / 2013-07-10

Basic loading data (for a single anchor)

All data in this section applies to

- Correct setting (See setting instruction)
- No edge distance and spacing influence
- Only for redundant fastening
- Values are only valid for tensile loading
- Concrete \geq C 20/25 ($f_{ck,cube} = 25 \text{ N/mm}^2$), \leq C50/60 ($f_{ck,cube} = 60 \text{ N/mm}^2$)

Recommended loads

		Non-cracked concrete	Cracked concrete (redundant fastening)
Anchor size			
Tensile N_{rec}	[kN]	0,8	0,8

Materials

Material quality

Part	Material
Expansion sleeve	Carbon steel, galvanised to min. 5 µm
Bolt	Carbon steel, galvanised to min. 5 µm

Mechanical properties of HA 8

Anchor size	HA 8 expansion sleeve	HA 8 bolt
Nominal tensile strength f_{uk} [N/mm ²]	370	460
Yield strength f_{yk} [N/mm ²]	270	220

Anchor dimensions

Anchor size			
Bolt diameter	d_R	[mm]	5
Length of the anchor	l_1	[mm]	66

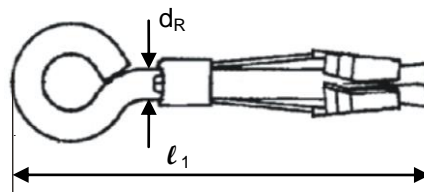

Setting

Installation equipment

Anchor size	
Rotary hammer	TE2 ... TE16
Other tools	hammer, blow out pump

Setting instruction

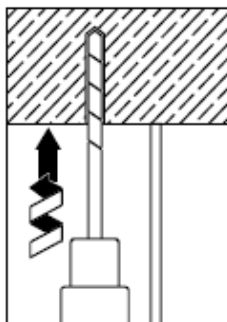

Drill hole with drill bit.

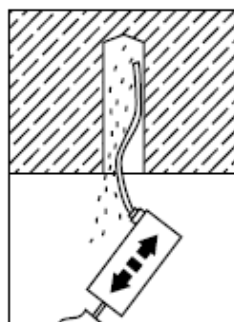

Blow out dust and fragments.

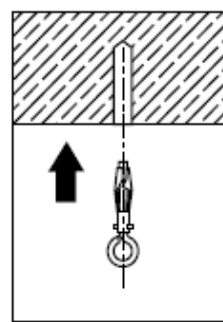

Install anchor.

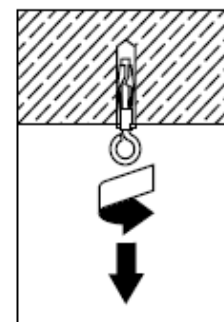

Pull to expand the anchor.

Setting details: depth of drill hole h_1 and effective anchorage depth h_{ef}

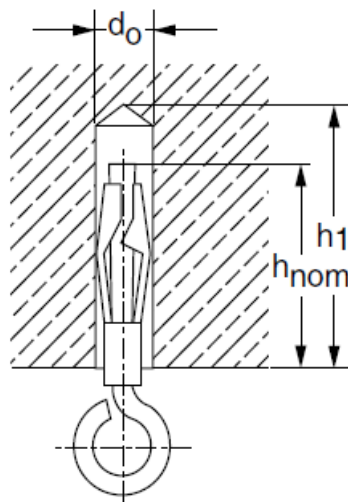

Setting details HA 8

Nominal diameter of drill bit	d_0	[mm]	8
Cutting diameter of drill bit	$d_{cut} \leq$	[mm]	8,45
Depth of drill hole	$h_1 \geq$	[mm]	50
Effective anchorage depth	h_{ef}	[mm]	40

Base material thickness, anchor spacing and edge distance

Anchor size			
Minimum base material thickness	h_{min}	[mm]	100
Minimum spacing	s	[mm]	200
Minimum edge distance	c	[mm]	100
Minimum edge distance at the corner	c_e	[mm]	150

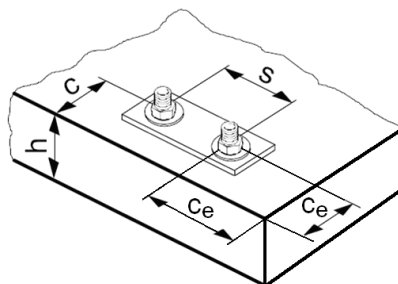

DBZ Wedge anchor

Anchor version	Benefits
 <p>DBZ Carbon steel</p>	<ul style="list-style-type: none"> - well proven - simple installation - small drill bit diameter - reliable setting thanks to simple visual check - for fixing in cracked concrete, redundant fastening only, e.g. suspended ceilings



Concrete

Tensile zone^{a)}

Redundant fastening



Fire resistance



European Technical Approval



CE conformity

a) Redundant fastening only

Approvals / certificates

Description	Authority / Laboratory	No. / date of issue
European technical approval ^{a)}	DIBt	ETA-06/0179, 2011-09-14
Fire test report	DIBt	ETA-06/0179, 2011-09-14
Assessment report (fire)	warringtonfire	WF 327804/A / 2013-07-10

a) All data given in this section for DBZ wedge anchor according ETA-06/0179, issue 2011-09-14. The anchor is to be used only for redundant fastening for non-structural applications.

Basic loading data for all load directions according design method C of ETAG 001

All data in this section applies to

- Correct setting (See setting instruction)
- No edge distance and spacing influence
- Concrete C 20/25 $f_{ck,cube} = 25 \text{ N/mm}^2$ to C50/60, $f_{ck,cube} = 60 \text{ N/mm}^2$
- Anchors in redundant fastening

Mean ultimate resistance, all load directions

Anchor size	DBZ 6/4,5	DBZ 6/35
Load $F_{R,u,m}$ [kN]	6,0	6,0

Characteristic resistance, all load directions

Anchor size	DBZ 6/4,5	DBZ 6/35
Resistance F_{Rk} [kN]	4,0	4,0

Design resistance, all load directions

Anchor size		DBZ 6/4,5	DBZ 6/35
Resistance F_{Rd}	[kN]	2,2	2,2

Recommended loads ^{a)}, all load directions

Anchor size		DBZ 6/4,5	DBZ 6/35
Resistance F_{Rec}	[kN]	1,6	1,6

a) With overall partial safety factor for action $\gamma = 1,4$. The partial safety factors for action depend on the type of loading and shall be taken from national regulations.

Requirements for redundant fastening

The definition of redundant fastening according to Member States is given in the ETAG 001 Part six, Annex 1. In Absence of a definition by a Member State the following default values may be taken

Minimum number of fixing points	Minimum number of anchors per fixing point	Maximum design load of action N_{Sd} per fixing point ^{a)}
3	1	2 kN
4	1	3 kN

a) The value for maximum design load of actions per fastening point N_{Sd} is valid in general that means all fastening points are considered in the design of the redundant structural system. The value N_{Sd} may be increased if the failure of one (= most unfavourable) fixing point is taken into account in the design (serviceability and ultimate limit state) of the structural system e.g. suspended ceiling.

Materials

Mechanical properties of DBZ

Anchor size		DBZ 6/4,5	DBZ 6/35
Nominal tensile strength	f_{uk} [N/mm ²]	390	390
Yield strength	f_{yk} [N/mm ²]	310	310
Stressed cross-section	A_s [mm ²]	26	26
Char. bending resistance	$M^0_{Rk,s}$ [Nm]	5,0	5,0

Material quality of DBZ

Part	Material
1 ... Anchor shank	Cold-formed steel; galvanized $\geq 5\mu\text{m}$
2 ... Expansion pin	Cold-formed steel; galvanized $\geq 5\mu\text{m}$

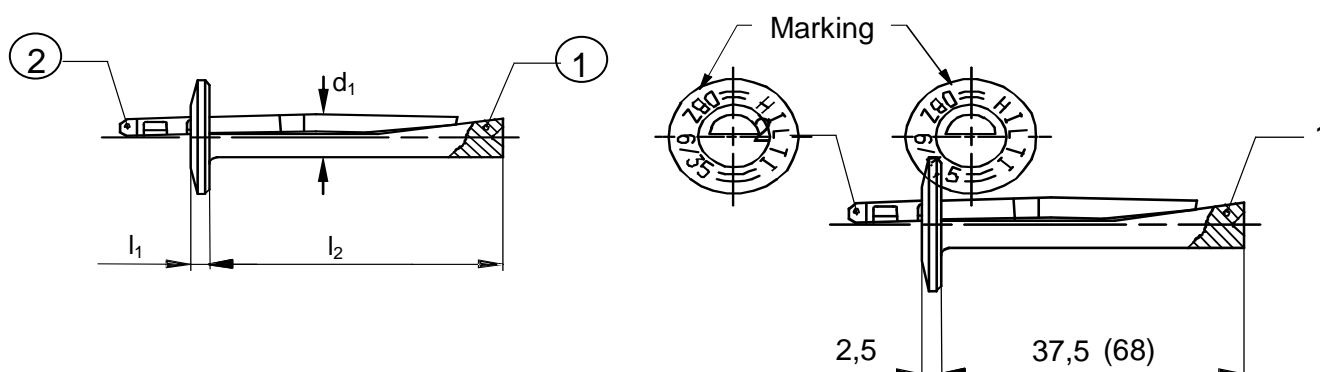

Anchor dimensions

Anchor size		DBZ 6/4,5	DBZ 6/35
Height anchor head	l_1 [mm]	2,5	2,5
Max. distance	d_1 [mm]	6,4	6,4
Length of anchor shaft	l_2 [mm]	37,5	68

Setting

Recommended installation equipment

Anchor size	DBZ 6/4,5	DBZ 6/35
Rotary hammer	TE 2 – TE 7	
Other tools	hammer, blow out pump	

Setting instruction

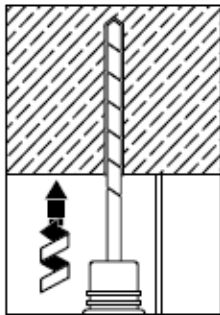

Drill hole with drill bit.

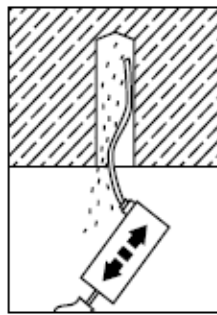

Blow out dust and fragments.

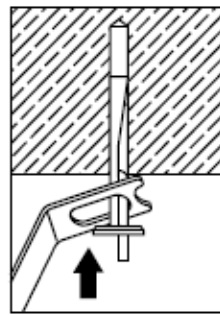

Install anchor with suspended item.

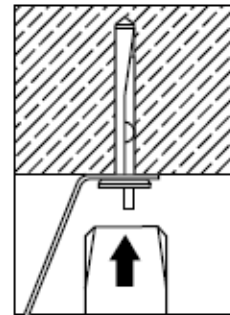

Hammer in anchor.

Setting details

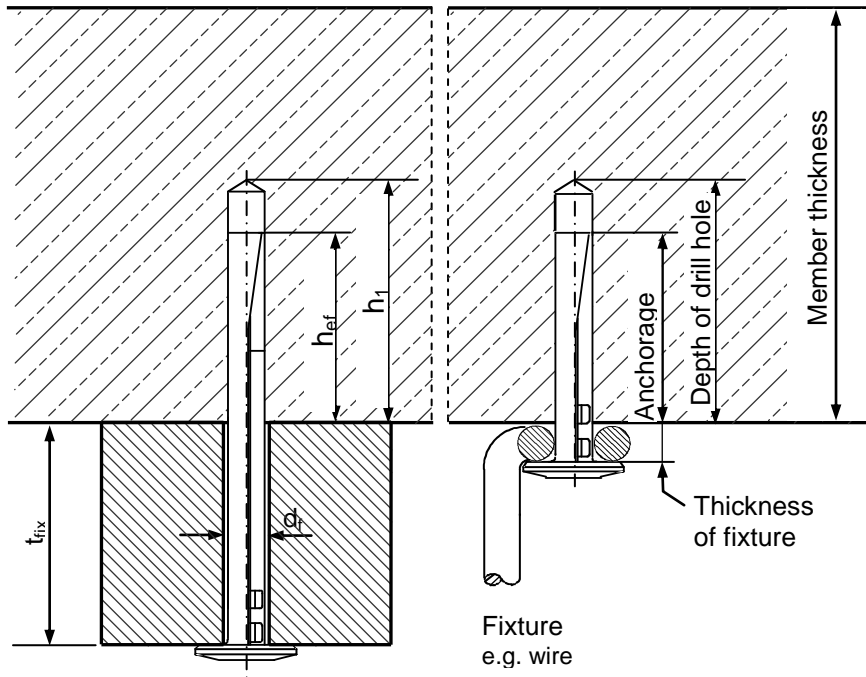

Anchor size		DBZ 6/4,5	DBZ 6/35	
Thickness of fixture	t_{fix} [mm]	$\leq 4,5$	$20 \leq t_{fix} \leq 35$	$5 \leq t_{fix} < 20$
Depth of drill hole	$h_1 \geq$ [mm]	40	55	70
Nominal diameter of drill bit	d_0 [mm]	6	6	
Cutting diameter of drill bit	$d_{cut} \leq$ [mm]	6,4	6,4	
Clearance hole diameter	$d_f \leq$ [mm]	7	7	

Base material thickness, anchor spacing and edge distance ^{a)}

Anchor size		DBZ 6/4,5	DBZ 6/35	
Thickness of fixture	t_{fix} [mm]	$\leq 4,5$	$20 \leq t_{fix} \leq 35$	$5 \leq t_{fix} < 20$
Minimum member thickness	$h_{min} \geq$ [mm]	80	80	100
Effective anchorage depth	h_{ef} [mm]	32	32	
Critical spacing	s_{cr} [mm]	200	200	
Critical edge distance	c_{cr} [mm]	150	150	

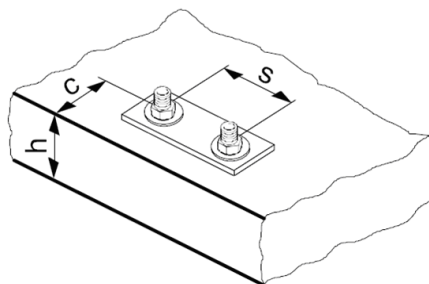

a) The critical spacing (critical edge distance) shall be kept. Smaller spacing (edge distance) than critical spacing (critical edge distance) are not covered by the design method.

HT Metal frame anchor

Anchor version	Benefits
 HT	<ul style="list-style-type: none"> - fastening door and window frames - no risk of distortion or forces of constraint - expansion cone can not be lost



Concrete

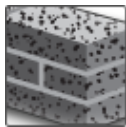

Solid brick

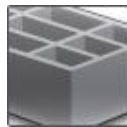

Hollow brick

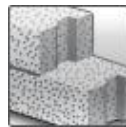
Autoclaved
aerated
concreteFire
resistance

Approvals / certificates

Description	Authority / Laboratory	No. / date of issue
Fire test report	IBMB, Braunschweig	UB 3016/1114-CM / 2006-03-13
Assessment report (fire)	warringtonfire	WF 327804/A / 2013-07-10

Basic loading data (for a single anchor)

All data in this section applies to

- Correct setting (See setting instruction)
- No edge distance and spacing influence
- Base material as specified in the table
- Non-cracked concrete: $f_{cc} \geq 20 \text{ N/mm}^2$
- Minimum base material thickness

Characteristic resistance

		HT 8	HT10
Concrete, $f_{cc} = 30 \text{ N/mm}^2$	N_{Rk} [kN]	4,2	5,0
	V_{Rk} [kN]	6,6	7,0
Aerated Concrete PP2 ^{a)}	N_{Rk} [kN]	-	0,3
	V_{Rk} [kN]	-	0,5
Solid brick Mz 12	N_{Rk} [kN]	1,8	2,6
	V_{Rk} [kN]	-	5,0
Sand-lime solid brick, KS 12	N_{Rk} [kN]	1,8	2,6
	V_{Rk} [kN]	-	5,0
Sand-lime hollow brick, KSL	N_{Rk} [kN]	-	1,5
	V_{Rk} [kN]	-	0,5

a) Rotary drilling only

Recommended loads

		HT 8	HT10
Concrete, $f_{cc} = 30 \text{ N/mm}^2$	N_{rec} [kN]	1,4	1,7
	V_{rec} [kN]	0,5	0,5
Aerated Concrete PP2 ^{a)}	N_{rec} [kN]	-	0,1
	V_{rec} [kN]	-	0,15
Solid brick Mz 12	N_{rec} [kN]	0,6	0,8
	V_{rec} [kN]	-	0,5
Sand-lime solid brick, KS 12	N_{rec} [kN]	0,6	0,8
	V_{rec} [kN]	-	0,5
Sand-lime hollow brick, KSL	N_{rec} [kN]	-	0,5
	V_{rec} [kN]	-	0,15

a) Rotary drilling only

Materials

Material quality

Part	Material
Bolt	steel strength 4.8, zinc plated to 5 μm
Sleeve	steel 02 DIN 17162, sendzimir zinc plated to 20 μm

Setting

installation equipment

Anchor size	
Rotary hammer	TE1 – TE16
Other tools	hammer, screwdriver

Setting instruction

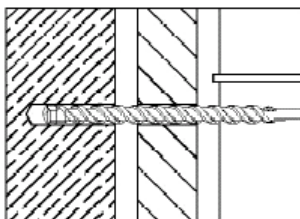

Drill hole with drill bit.

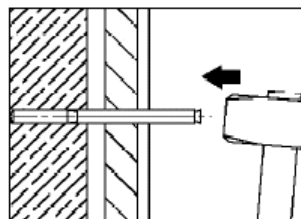

Install anchor.

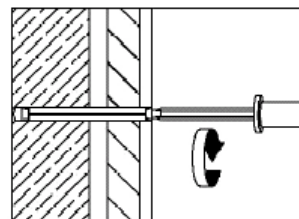

Drive screw into anchor.

For detailed information on installation see instruction for use given with the package of the product.

Setting details: anchor length L and anchorage depth h_{nom}

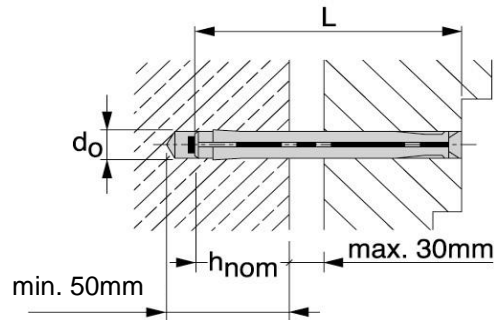

Setting details HT

		HT 8	8x72	8x92	8x112
Nominal diameter of drill bit	d_o	[mm]	8	8	8
Depth of drill hole	h_1	[mm]	50	50	50
Anchorage depth	h_{nom}	[mm]	30	30	30
Anchor length	L	[mm]	72	92	112
Torque moment	T_{inst}	[Nm]	4	4	4
Minimum base material thickness	h_{min}	[mm]	100	100	100
Drill bit			TE-CX-8/17		TE-CX-8/22

		HT 8	8x132	8x152	8x182
Nominal diameter of drill bit	d_o	[mm]	8	8	8
Depth of drill hole	h_1	[mm]	50	50	50
Anchorage depth	h_{nom}	[mm]	30	30	30
Anchor length	L	[mm]	132	152	182
Torque moment	T_{inst}	[Nm]	4	4	4
Minimum base material thickness	h_{min}	[mm]	100	100	100
Drill bit			TE-CX-8/22	TE-CX-8/27	



		HT 10	10x72	10x92	10x112
Nominal diameter of drill bit	d_o	[mm]	10	10	10
Depth of drill hole	h_1	[mm]	50	50	50
Anchorage depth	h_{nom}	[mm]	30	30	30
Anchor length	L	[mm]	72	92	112
Torque moment	$T_{inst}^{a)}$	[Nm]	8/4	8/4	8/4
Minimum base material thickness	h_{min}	[mm]	100	100	100
Drill bit			TE-C-10/17		TE-C-10/22

a) First value: solid base material, second value: hollow base material

		HT 10	10x132	10x152	10x182	10x202
Nominal diameter of drill bit	d_o	[mm]	10	10	10	10
Depth of drill hole	h_1	[mm]	50	50	50	50
Anchorage depth	h_o	[mm]	30	30	30	30
Anchor length	L	[mm]	132	152	182	202
Torque moment	$T_{inst}^{a)}$	[Nm]	8/4	8/4	8/4	8/4
Minimum base material thickness	h_{min}	[mm]	100	100	100	100
Drill bit			TE-C-10/22	TE-C-10/27		TE-C-10/37

a) First value: solid base material, second value: hollow base material

HK Ceiling anchor

Anchor version		Benefits
	HK	- well proven - small drill bit diameter - for fixing in cracked concrete, redundant fastening only, e.g. suspended ceilings
	HK I	



Concrete



Tensile zone^{a)}

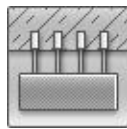

Redundant fastening



Fire resistance



European Technical Approval



CE conformity

a) Redundant fastening only

Approvals / certificates

Description	Authority / Laboratory	No. / date of issue
European technical approval ^{a)}	DIBt	ETA-04/0043, 2013-06-11
Fire test report	DIBt	ETA-04/0043, 2013-06-11
Assessment report (fire)	warringtonfire	WF 327804/A / 2013-07-10

a) All data given in this section for HK Ceiling anchor according ETA-04/0043, issue 2013-06-11. The anchor is to be used only for multiple use for non-structural applications.

Basic loading data (for a single anchor)

All data in this section applies to

- Correct setting (see setting instruction)
- No edge distance and spacing influence.
- Concrete C 20/25, $f_{ck,cube} = 25 \text{ N/mm}^2$ to C50/60, $f_{ck,cube} = 60 \text{ N/mm}^2$
- Anchors in multiple use

Characteristic resistance, all load directions

Anchor size (carbon steel)	HK6	HK6L	HK8
Resistance F_{Rk} ^{a)} [kN]	2,0	5,0	5,0
Anchor size (stainless steel, HCR)	HK6 -R /-HCR	HK6L -R /-HCR	HK8 -R /-HCR
Resistance F_{Rk} ^{a)} [kN]	1,5	3,0	5,0

a) for all load directions (tension, shear and combined tension and shear loads)

Design resistance, all load directions

Anchor size (carbon steel)		HK6	HK6L	HK8
Resistance F_{Rd}^a	[kN]	1,1	2,0	2,0
Anchor size (stainless steel, HCR)		HK6 -R /-HCR	HK6L -R /-HCR	HK8 -R /-HCR
Resistance F_{Rd}^a	[kN]	0,6	1,2	2,3

a) for all load directions (tension, shear and combined tension and shear loads)

Recommended loads ^{a)}, all load directions

Anchor size (carbon steel)		HK6	HK6L	HK8
Resistance F_{rec}^b	[kN]	0,8	1,4	1,4
Anchor size (stainless steel, HCR)		HK6 -R /-HCR	HK6L -R /-HCR	HK8 -R /-HCR
Resistance F_{rec}^b	[kN]	0,4	0,8	1,6

a) With overall partial safety factor for action $\gamma = 1,4$. The partial safety factors for action depend on the type of loading and shall be taken from national regulations.

b) for all load directions (tension, shear and combined tension and shear loads)

Special case: Groups of $n=2$ and/or $n=4$ anchors with small spacing

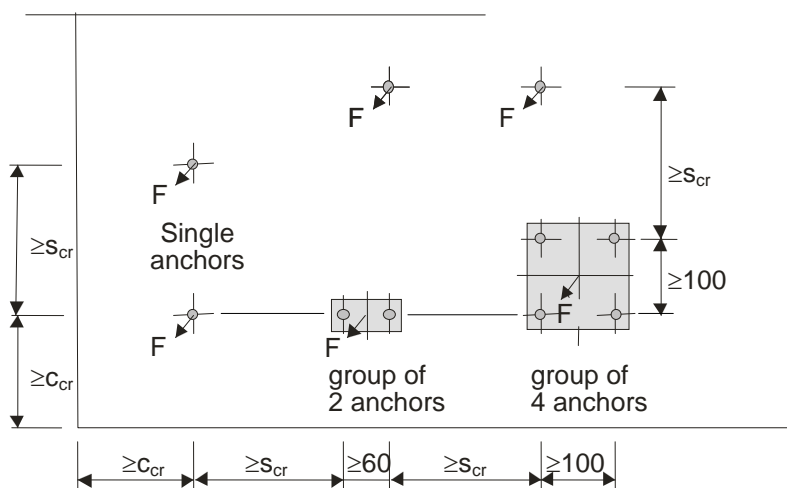

The basic loading data for a single anchor is valid for one fixing point.

Fixing points can be:

- **single anchors,**
- or
- **groups of 2 anchors** with $s_1 \geq 60$ mm
- or
- **groups of 4 anchors** with $s_1 \geq 100$ mm and $s_2 \geq 100$ mm

Requirements for multiple use

The definition of multiple use according to Member States is given in the ETAG 001 Part six, Annex 1. In Absence of a definition by a Member State the following default values may be taken

Minimum number of fixing points	Minimum number of anchors per fixing point	Maximum design load of action N_{Sd} per fixing point ^{a)}
3	1	2 kN
4	1	3 kN

a) The value for maximum design load of actions per fastening point N_{Sd} is valid in general that means all fastening points are considered in the design of the redundant structural system. The value N_{Sd} may be increased if the failure of one (= most unfavourable) fixing point is taken into account in the design (serviceability and ultimate limit state) of the structural system e.g. suspended ceiling.

Materials

Mechanical properties of HK

Anchor size (carbon steel)	HK6	HK6L	HK8
Char. bending resistance ^{a)} $M^0_{Rk,s}$ [Nm]	3,6	7,7	18

a) Partial material safety factor $\gamma_{Ms} = 1,25$.

Anchor size (stainless steel, HCR)	HK6 -R /-HCR	HK6L -R /-HCR	HK8 -R /-HCR
Char. bending resistance ^{a)} $M^0_{Rk,s}$ [Nm]	4,0	8,4	20,6

a) Partial material safety factor $\gamma_{Ms} = 1,5$.

Material quality of HK

Part	Marking	Material
Anchor HK6 Anchor HK6L Anchor HK8	K6 K6L K8	galvanised steel $\geq 5 \mu\text{m}$
Anchor HK6 -R Anchor HK6L -R Anchor HK8 -R	K6E K6LE K8E K6X K6LX K8X	stainless steel, 1.4401 or 1.4404 stainless steel, 1.4571
Anchor HK6 -HCR Anchor HK6L -HCR Anchor HK8 -HCR	K6C K6LC K8C	high corrosion resistant steel, 1.4529 or 1.4565

Anchor dimension

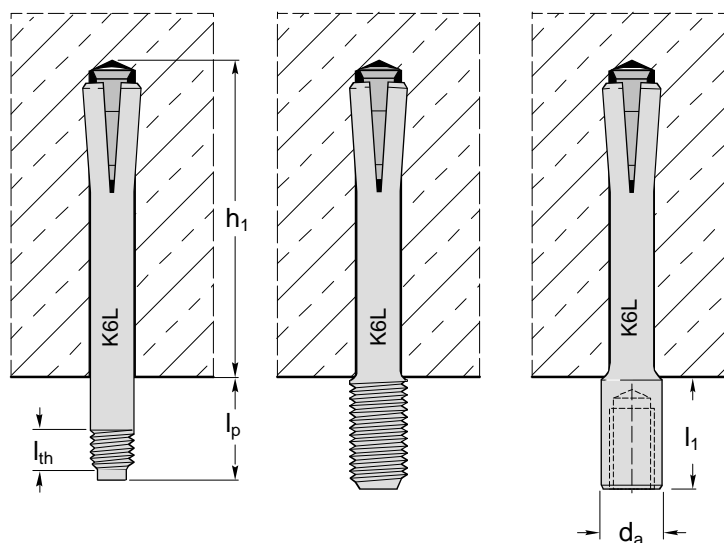

Anchor size	HK6			HK6L			
	M6/ t_{fix}	M8/ t_{fix}	M6/4	M6/ t_{fix}	M8/ t_{fix}	I M6	I M8
Thread size	external M6	external M8	external M6	external M6	external M8	internal M6	internal M8

Length of thread	l_{th} [mm]	5 ... 50	≥ 5	≥ 5	≥ 5	12	12
Length of projection	l_p [mm]	$t_{fix} + 7$	11	≤ 300	≤ 300	-	-
Diameter of sleeve	d_a [mm]	-	-	-	-	8	10
Length of sleeve	l_1 [mm]	-	-	-	-	15	15

Anchor size	HK8				
	I M8	I M10	I M12	I M8/M10	
Thread size	internal M8	internal M10	internal M12	internal M8/M10	
Diameter of sleeve	d_a [mm]	10	12	14	12
Length of sleeve	l_1 [mm]	15	20	20	25

Setting

Recommended installation equipment

Anchor size	HK6	HKL	HK8
Rotary hammer	TE 2 – TE 16		
Stop drill bit	SDS 2		SDS 3
Setting tool	HSM ... / HSM I ...		HSM 8 ... / HSM 8 I ...
Other tools	blow out pump		

Setting instruction

Setting of HK

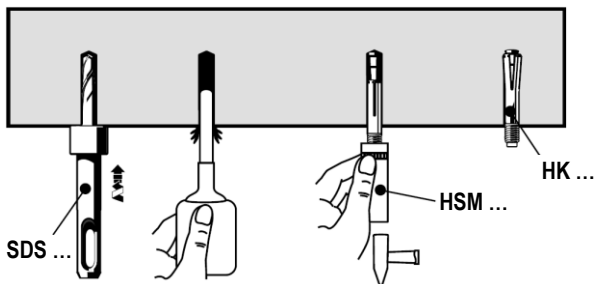

a) with hand setting tool

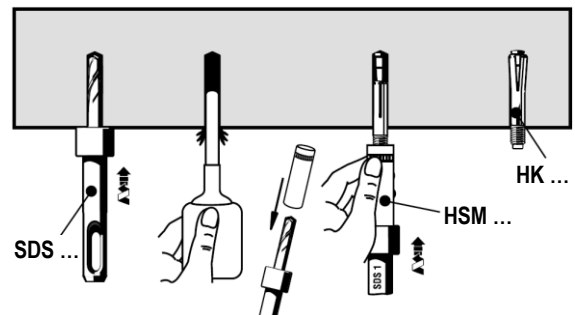

b) with machine setting tool

Setting of HK-I

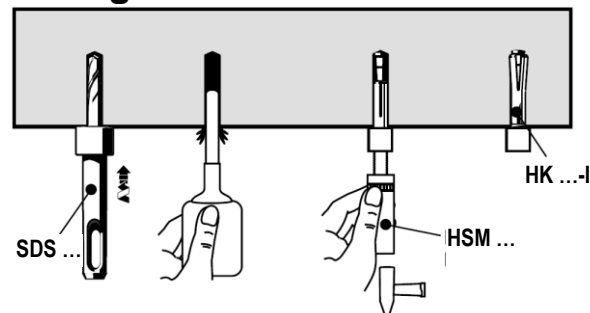

a) with hand setting tool

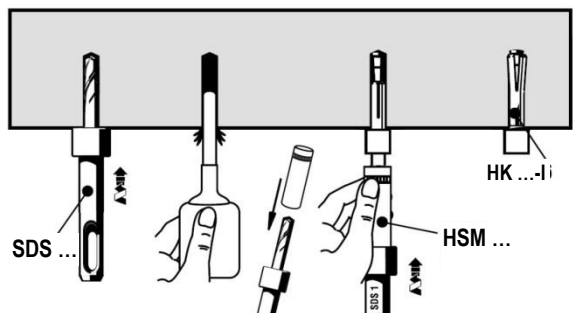

b) with machine setting tool

Setting details

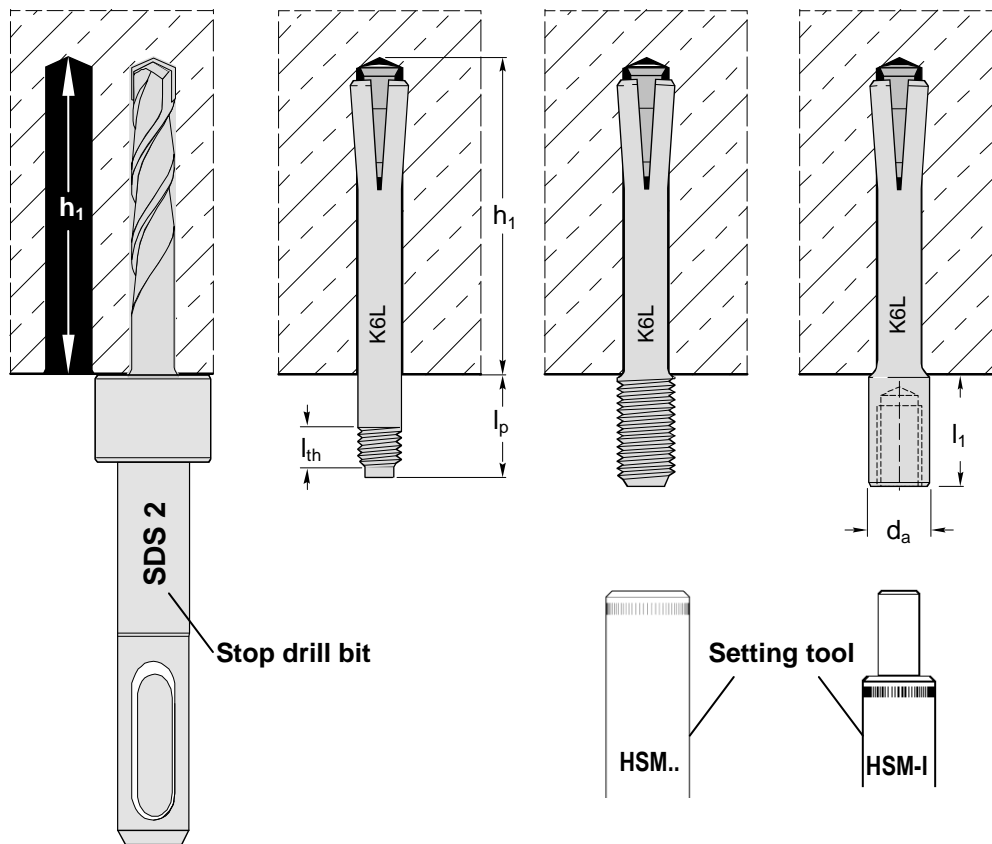

Anchor size	HK6		HKL				
	M6/t _{fix}	M8/t _{fix}	M6/4	M6/t _{fix}	M8/t _{fix}	I M6	I M8
Stop drill bit ^{a)}	SDS 1		SDS 2				
Depth of drill hole ^{b)} h ₁ [mm]	32		42				
Nominal diameter of drill bit d ₀ [mm]	6		6				
Setting tool	HSM 6 / t _{fix}	HSM 8 / t _{fix}	HSM 6 / 4	HSM 6 / t _{fix}	HSM 8 / t _{fix}	HSM I M6	HSM I M8
Clearance hole d _f ≤ [mm]	7	9	7	7	9	9	12
Max. torque moment T _{max} [Nm]	5		5				

Anchor size	HK8			
	I M8	I M10	I M12	I M8/M10
Stop drill bit ^{a)}	SDS 3			
Depth of drill hole ^{b)} h ₁ [mm]	43			
Nominal diameter of drill bit d ₀ [mm]	8			
Setting tool	HSM 8 I M8	HSM 8 I M10	HSM 8 I M12	HSM 8 I M8
Clearance hole d _f ≤ [mm]	12	14	16	14
Max. torque moment T _{max} [Nm]	10			

- a) In case of through setting choose stop drill bit with appropriate length
- b) Use stop drill bit to ensure correct depth of bore hole

Base material thickness, anchor spacing and edge distance ^{a)}

Anchor size		HK6	HKL	HK8
Minimum member thickness	$h_{\min} \geq$ [mm]	80		
Effective anchorage depth	h_{ef} [mm]	26	36	36
Critical spacing	s_{cr} [mm]	200		
Critical edge distance	c_{cr} [mm]	150		

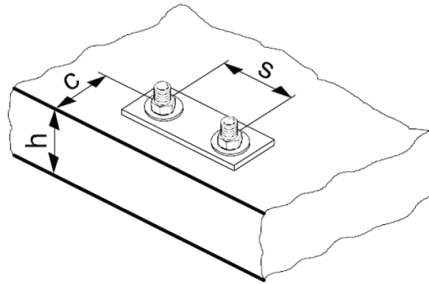

- a) The critical spacing (critical edge distance) shall be kept. Smaller spacing (edge distance) than critical spacing (critical edge distance) are not covered by the design method.

HPD Aerated concrete anchor

Anchor version	Benefits
 <p>HPD</p>	<ul style="list-style-type: none"> - anchor for autoclaved aerated concrete - maximum use of base material capacity - setting without drilling



Autoclaved
aerated
concrete



Fire
resistance



Sprinkler
approved

Approvals / certificates

Description	Authority / Laboratory	No. / date of issue
Allgemeine bauaufsichtliche Zulassung (national approval in Germany) ^{a)}	DIBt, Berlin	Z-21.1-1729 / 2011-05-31
Fire test report	IBMB, Braunschweig	UB 3077/3602-Nau- / 2002-02-05
Assessment report (fire)	warringtonfire	WF 327804/A / 2013-07-10
Sprinkler	VdS, Cologne	G 4981083 / 2008-01-01

a) All data given in this section according Z-21.1-1729, issue 2011-05-31.

Basic loading data (for a single anchor)

All data in this section applies to

- Correct setting (See setting instruction)
 - No edge distance and spacing influence
 - Autoclaved aerated concrete (AAC)
 - Load data given in the tables is independent of load direction
- Minimum base material thickness

Recommended loads

Anchor size			Non-cracked AAC ^{a)}			Cracked AAC		
			M6	M8	M10	M6	M8	M10
Recommended load for a single anchor								
AAC blocks,	AAC 2	[kN]	0,4	0,4	0,6	-	-	-
	AAC 4, AAC 6	[kN]	0,8	0,8	1,2	-	-	-
AAC wall members	P 3,3	[kN]	0,6	0,6	0,8	-	-	-
	P 4,4	[kN]	0,8	0,8	1,2	-	-	-
AAC ceiling members	P 3,3	[kN]	-	-	-	0,6	0,6	0,8
	P 4,4	[kN]	-	-	-	0,8	0,8	1,2
Recommended load for a group of two anchor with a spacing $100\text{mm} \leq s \leq 200\text{mm}$								
AAC blocks,	AAC 2	[kN]	0,4	0,4	0,6	-	-	-
	AAC 4, AAC 6	[kN]	0,8	0,8	1,2	-	-	-
AAC wall members	P 3,3	[kN]	0,6	0,6	0,8	-	-	-
	P 4,4	[kN]	0,8	0,8	1,2	-	-	-
AAC ceiling members	P 3,3	[kN]	-	-	-	0,6	0,6	0,8
	P 4,4	[kN]	-	-	-	0,8	0,8	1,2
Recommended load for a group of two anchor with a spacing $s \geq 200\text{mm}$								
AAC blocks,	AAC 2	[kN]	0,6	0,6	0,8	-	-	-
	AAC 4, AAC 6	[kN]	1,1	1,1	1,7	-	-	-
AAC wall members	P 3,3	[kN]	0,8	0,8	1,1	-	-	-
	P 4,4	[kN]	1,1	1,1	1,7	-	-	-
AAC ceiling members	P 3,3	[kN]	-	-	-	0,8	0,8	1,1
	P 4,4	[kN]	-	-	-	1,1	1,1	1,7

a) in case of small sized AAC blocks ($\leq 250\text{mm} \times 500\text{mm} \times \text{thickness}$) the recommended load has to be reduced with a factor 0,6.

Materials

Mechanical properties of HPD

Anchor size		M6	M8	M10
Nominal tensile strength f_{uk}	Carbon steel [N/mm ²]	800	500	500
	Stainless steel [N/mm ²]	750	565	565
Yield strength f_{yk}	Carbon steel [N/mm ²]	-	-	-
	Stainless steel [N/mm ²]	-	-	-
Stressed cross-section A_s	[mm ²]	20,1	36,6	58
Moment of resistance W	[mm ³]	12,7	31,2	62,3
Char. bending resistance $M_{Rk,s}^0$	Carbon steel [Nm]	12	19	37
	Stainless steel [Nm]	11	21	42

The recommended bending moment shall be calculated by dividing the characteristic bending moment by 1,4 and 1,25

Material quality

Part	Material	
All parts	HPD	Carbon steel, galvanised to min. 5 µm
	HPD (stainless steel)	Stainless steel

Anchor dimensions

Anchor size		M6	M8	M10
Minimum thickness of fixture	$t_{\text{fix,min}}$ [mm]	0	0	0
Maximum thickness of fixture*	$t_{\text{fix,max}}$ [mm]	30	20	30
Anchor diameter	d_1 [mm]	9,8	11,8	13,8
Length of the expansion sleeve	l_c [mm]	70		
Length of the cone	l_d [mm]	12		

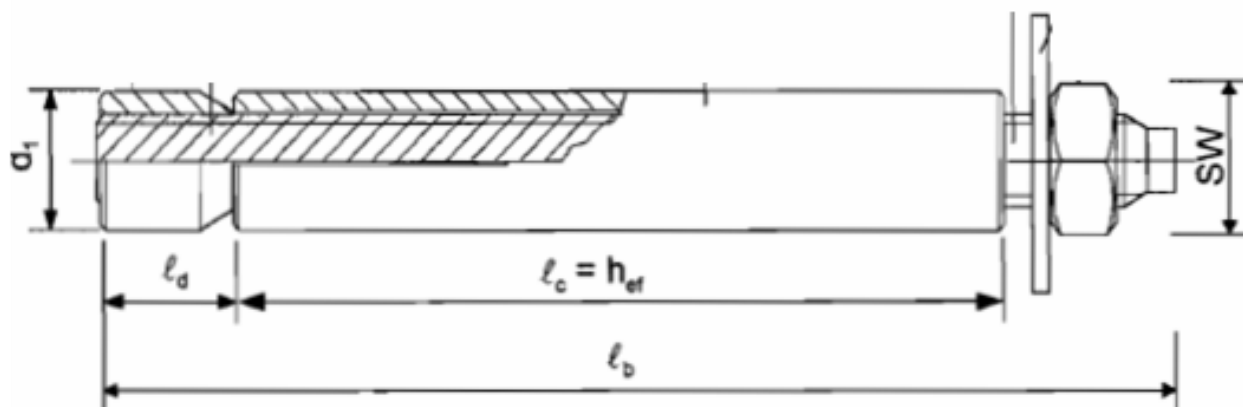

Setting

Installation equipment

Anchor size		M6/10	M6/30	M8/10	M8/20	M10/10	M10/30
Setting tools	Manual setting tool (to be used with a hammer)	HPE-G 6/10	HPE-G 6/30	HPE-G 8/10	HPE-G 8/20	-	-
	Machine setting (to be used with a rotary hammer in pure hammering mode)	-	-	-	-	HPE-M 10/10	HPE-M 10/30

Setting instruction

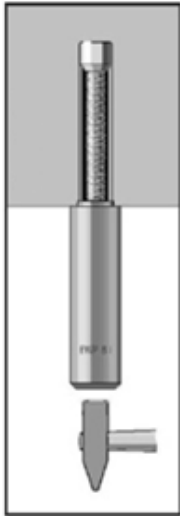

Insert the cone bolt by hammering it in, until setting tool touches surface.

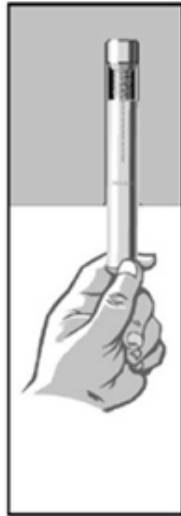

Insert the expansion sleeve over the threaded rod.

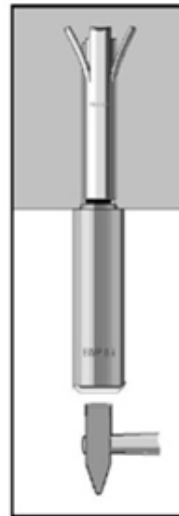

Bash in the sleeve by hammering or with the machine setting tool.

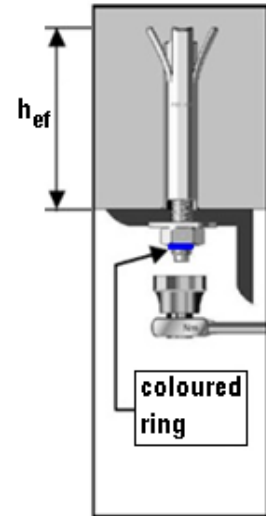

Tighten the nut until the blue ring becomes visible.

Setting details: depth of drill hole h_1 and effective anchorage depth h_{ef}

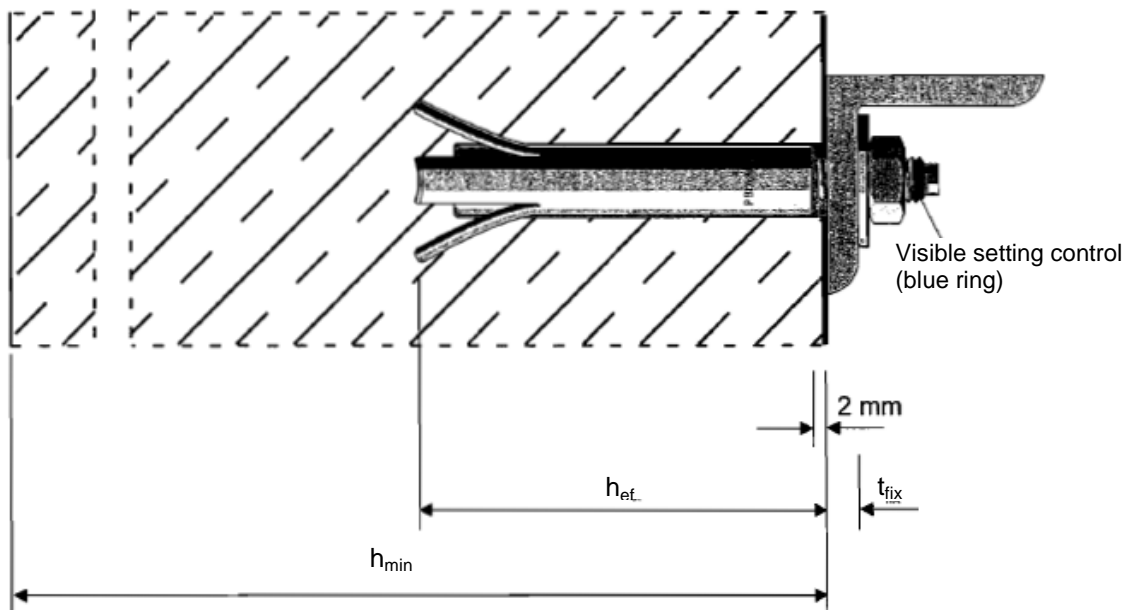

Setting details HPD

			M6	M8	M10
Diameter of clearance hole in the fixture	$d_f \leq$	[mm]	7	9	12
Effective anchorage depth	h_{ef}	[mm]	62	62	62
Torque moment	T_{inst}	[Nm]	3	5	8
Width across	SW	[mm]	10	13	17

Base material thickness, anchor spacing and edge distance

Anchor size			M8	M10	M12
Minimum base material thickness	h_{min}	[mm]	175		
Minimum spacing	Of anchors in a group	$S_{min,anchor}$	100 / 200		
	Of anchor groups	$S_{min,group}$	600		
Minimum edge distance	to member edge and to vertical joints	$C_{min,1}$	150	150	150
	to horizontal joints	$C_{min,2}$	50	50	50

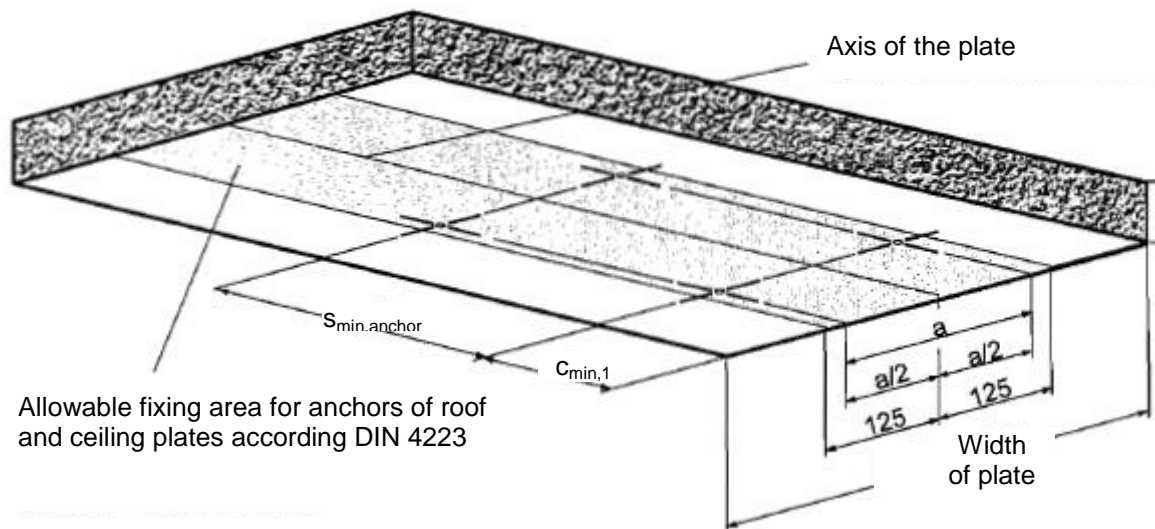
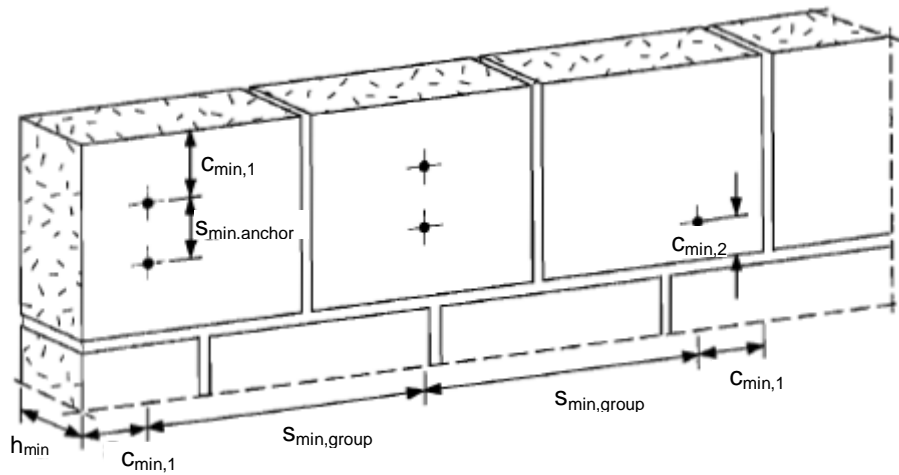

HKH Hollow deck anchor

Anchor version	Benefits
 <p>HKH</p>	<ul style="list-style-type: none"> - anchor for suspended ceilings & overhead support applications - channel installation - optical setting control



Prestressed hollow core slabs



Fire resistance

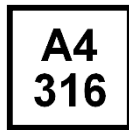

Corrosion resistance



Sprinkler approved

Approvals / certificates

Description	Authority / Laboratory	No. / date of issue
Allgemeine bauaufsichtliche Zulassung (national approval in Germany for single point fastening) ^{a)}	DIBt, Berlin	Z-21.1-1722 / 2011-10-31
Fire test report	IBMB, Braunschweig	UB 3606 / 8892 / 2002-07-22
Assessment report (fire)	warringtonfire	WF 327804/A / 2013-07-10
Sprinkler	VdS, Cologne	G 4961028 / 2006-09-05

a) All data given in this section according DIBt approval Z-21.1-1722, issue 2011-10-31.

Basic loading data (for a single anchor)

All data in this section applies to

- Correct setting (See setting instruction)
- No edge distance and spacing influence
- Hollow decks where $b_H \leq 4,2 \cdot b_{st}$
- concrete $f_{cc} \geq 50 \text{ N/mm}^2$
- Load data for each load direction

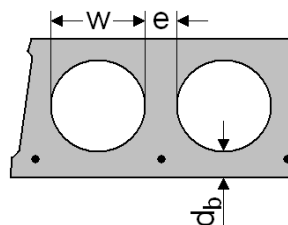

Recommended loads

Anchor size	M6	M8	M10	M6	M8	M10	M6	M8	M10
Recommended load for a single anchor									
Cavity to surface thickness d_b [mm]	≥ 25			≥ 30			≥ 40		
Tensile, F_{rec} [kN]	0,7	0,7	0,9	0,9	0,9	1,2	2,0	2,0	3,0
Recommended load for a group of two anchors with a spacing $s \geq 100$ mm and ≤ 200 mm									
Tensile, F_{rec} spacing $s \geq 100$ mm [kN]	0,9	0,9	1,2	1,2	1,2	1,6	2,5	2,5	4,0
Tensile, F_{rec} spacing, $s \geq 200$ mm [kN]	1,1	1,1	1,5	1,5	1,5	2,0	3,3	3,3	5,0
Recommended load for a group of four anchors with a spacing $s \geq 100$ mm and ≤ 200 mm									
Tensile, F_{rec} spacing, $s \geq 100/100$ mm [kN]	1,2	1,2	1,6	1,6	1,6	2,1	3,5	3,5	5,3
Tensile, F_{rec} spacing, $s \geq 100/200$ mm [kN]	1,5	1,5	2,0	2,0	2,0	2,6	4,4	4,4	6,6
Tensile, F_{rec} spacing, $s \geq 200/200$ mm [kN]	1,9	1,9	2,5	2,5	2,5	3,3	5,5	5,5	8,3

The given loads are valid for tensile load, shear load and all load directions

All data applies to:

- Hollow decks, classification $\geq C 45/55$
- Hollow decks where $b_H \leq 4,2 \cdot b_{st}$

Materials

Mechanical properties of HKH

Anchor size		M6	M8	M10
Nominal tensile strength f_{uk}	Carbon steel [N/mm ²]	800	500	500
	Stainless steel [N/mm ²]	700	700	700
admissible bending resistance	Carbon steel [Nm]	7,0	10,7	21,4
	Stainless steel [Nm]	4,9	12,1	24,1

Material quality

Part	Material	
All parts	HKH (Carbon steel)	galvanised to min. 5 μ m
	HKH (stainless steel)	Stainless steel A4

Anchor dimensions

Anchor size		M6	M8	M10
t_{fix}	[mm]	≤ 10	≤ 10	≤ 10
l_1	[mm]	0	0	0
l_{h1}	[mm]	10	10	10
d	[mm]	9,8	11,8	13,8
l	[mm]	86	88	93
l_h	[mm]	55		

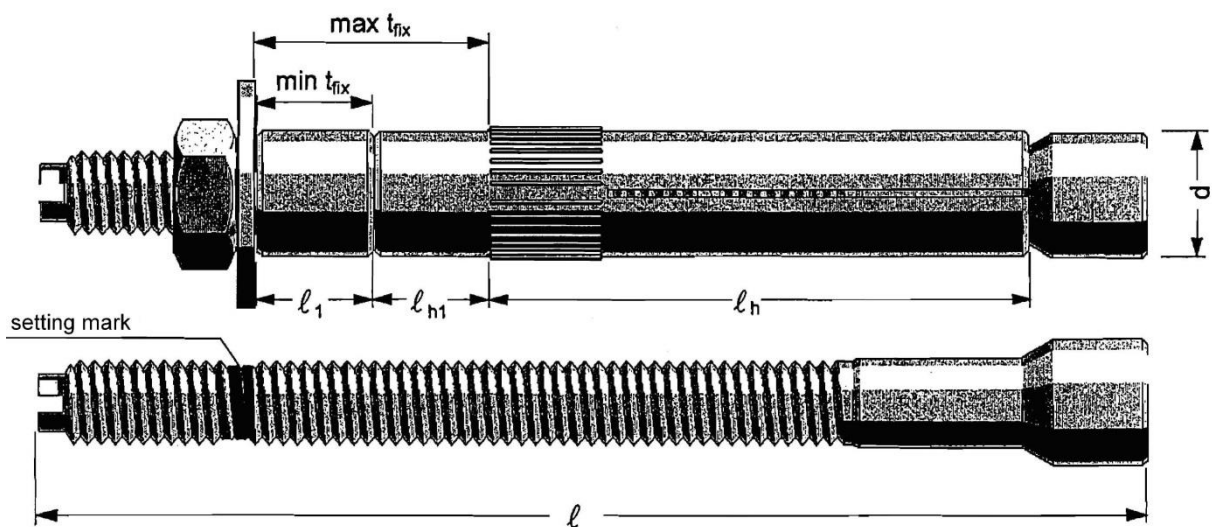

Setting

Installation equipment

Anchor size		M6	M8	M10
Diameter of drill bit	d_0 [mm]	10	12	14
Drill bit		TE-CX-10	TE-CX-12	TE-CX-14
Rotary hammer		TE 6A, TE 6C, TE 6S, TE 15, TE 15-C or TE 18-M		
Setting tools		Torque wrench		
Machine setting tool		available		

Setting instruction

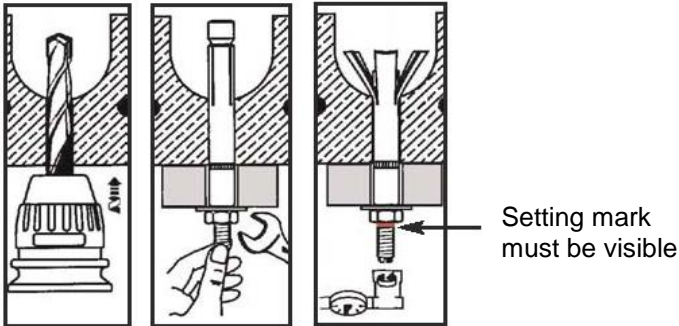

Setting details HKH

Anchor size		M6	M8	M10
Diameter of clearance hole in the fixture	$d_f \leq$ [mm]	12	14	16
Embedment depth for HKH	h_s [mm]	55 to 65		
Thickness of fixture	t_{fix} [mm]	≤ 10		
Torque moment	T_{inst} [Nm]	5	10	20
Width across	SW [mm]	10	13	17

Base material thickness, anchor spacing and edge distance

Anchor size		M6	M8	M10
Edge distance ^{a)}	$c \geq$ [mm]	150		
	$c_{min} \geq$ [mm]	100		
Spacing between outer anchors of neighbouring fixation	$a \geq$ [mm]	300		

a) For edge distance < 150 mm the recommended load has to be reduced with $F = 0,75 \cdot F_{rec}$

Specification: $b_H \leq 4,2 \cdot b_{st}$

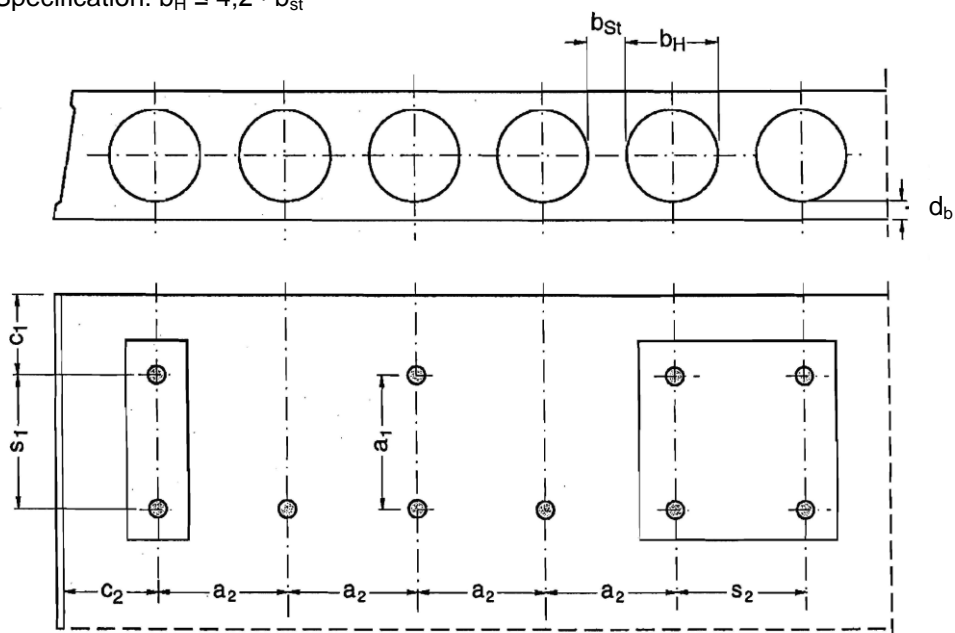

HTB Hollow wall metal anchor

Anchor version	Benefits
 <p>HTB</p>	<ul style="list-style-type: none"> - Ingenious and strong for hollow base materials - Convincing simplicity when setting - Technical superiority with up to 92mm fixing thickness - Load carried by strong metal channel and screw



Drywall

Basic loading data (for a single anchor)

All data in this section applies to

- Correct setting (See setting instruction)
- No edge distance and spacing influence
- Base material as specified in the table
- Minimum base material thickness

Characteristic resistance

Anchor size		M5 / M6
Gypsum board Thickness 10 mm	N_{Rk} [kN]	0,75
	V_{Rk} [kN]	0,45
Gypsum board Thickness 12,5 mm	N_{Rk} [kN]	1,20
	V_{Rk} [kN]	0,90
Gypsum board Thickness 2x12,5 mm	N_{Rk} [kN]	2,10
	V_{Rk} [kN]	0,90
Fibre reinforced gypsum board Thickness 10 mm	N_{Rk} [kN]	1,20
	V_{Rk} [kN]	1,80
Fibre reinforced gypsum board Thickness 12,5 mm	N_{Rk} [kN]	1,80
	V_{Rk} [kN]	3,00
Hollow decks Cavity to surface thickness $\geq 30,0$ mm	N_{Rk} [kN]	1,50
	V_{Rk} [kN]	-
Hollow brick "Parpaing Creux B40"	N_{Rk} [kN]	1,35
	V_{Rk} [kN]	2,70

Design resistance

Anchor size		M5 / M6
Gypsum board Thickness 10 mm	N_{Rd} [kN]	0,35
	V_{Rd} [kN]	0,21
Gypsum board Thickness 12,5 mm	N_{Rd} [kN]	0,56
	V_{Rd} [kN]	0,42
Gypsum board Thickness 2x12,5 mm	N_{Rd} [kN]	0,98
	V_{Rd} [kN]	0,42
Fibre reinforced gypsum board Thickness 10 mm	N_{Rd} [kN]	0,56
	V_{Rd} [kN]	0,84
Fibre reinforced gypsum board Thickness 12,5 mm	N_{Rd} [kN]	0,84
	V_{Rd} [kN]	1,40
Hollow decks Cavity to surface thickness $\geq 30,0$ mm	N_{Rd} [kN]	0,70
	V_{Rd} [kN]	-
Hollow brick "Parpaing Creux B40"	N_{Rd} [kN]	0,63
	V_{Rd} [kN]	1,26

Recommended loads ^{a)}

Anchor size		M5 / M6
Gypsum board Thickness 10 mm	N_{rec} [kN]	0,25
	V_{rec} [kN]	0,15
Gypsum board Thickness 12,5 mm	N_{rec} [kN]	0,40
	V_{rec} [kN]	0,30
Gypsum board Thickness 2x12,5 mm	N_{rec} [kN]	0,70
	V_{rec} [kN]	0,30
Fibre reinforced gypsum board Thickness 10 mm	N_{rec} [kN]	0,40
	V_{rec} [kN]	0,60
Fibre reinforced gypsum board Thickness 12,5 mm	N_{rec} [kN]	0,60
	V_{rec} [kN]	1,00
Hollow decks Cavity to surface thickness $\geq 30,0$ mm	N_{rec} [kN]	0,50
	V_{rec} [kN]	-
Hollow brick "Parpaing Creux B40"	N_{rec} [kN]	0,45
	V_{rec} [kN]	0,90

a) With overall global safety factor $\gamma = 3$ to the characteristic loads and a partial safety factor of $\gamma = 1,4$ to the design values

Materials

Material quality

Part	Material
Metal channel	Carbon steel galvanized to 5 microns
Cap washer	Polypropylene copolymer
Legs	High impact polystyrene
Screw	Carbon steel galvanized to 3 microns

Setting

Installation equipment

Anchor size	M5 / M6
Rotary hammer	TE2 ... TE16
Other tools	Screwdriver

Setting instruction

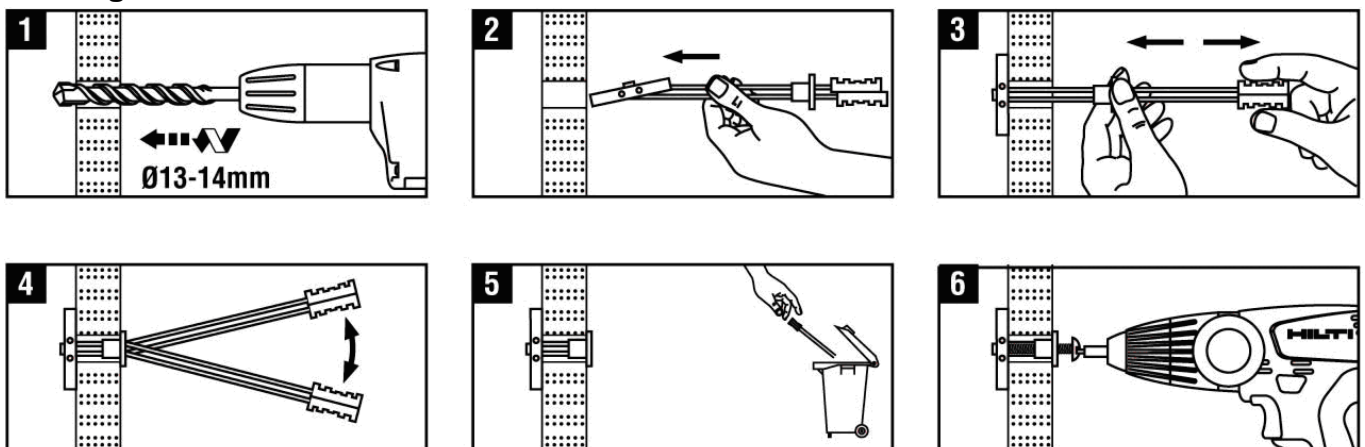

Setting details:

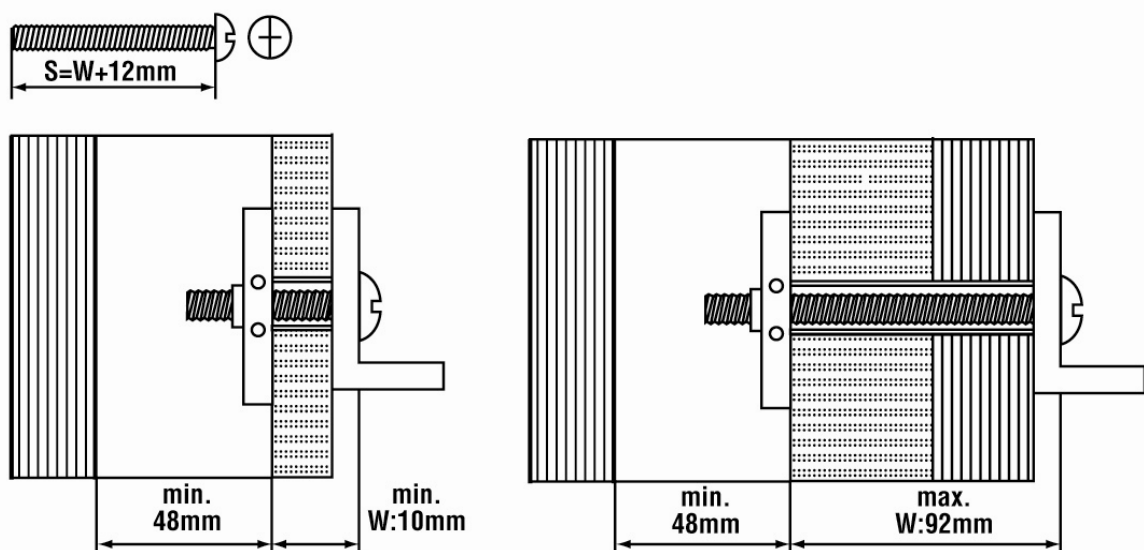

Setting details HTB

Anchor version			M5	M6
Nominal diameter of drill bit	d_o	[mm]	13 - 14	
Thickness of wall and fixture	min	$h + t_{fix}$ [mm]	10	
	max	$h + t_{fix}$ [mm]	92	
Minimum space of cavity	l	[mm]	48	
Screw length	l	[mm]	$12 + h + t_{fix}$	
Screw size	d		M5	M6
Tightening torque	T_{inst}	[Nm]	3	5

HIF Insulation fastener

Anchor version	Benefits
 <p>HIF</p>	<ul style="list-style-type: none"> - Especially for soft insulation material 90mm is ideal not to sink in the surface, no additional plate has to be used - Drilling, hammering, done - Speed due to less drilling effort - With anchors up to 240mm insulation thickness the whole application is covered



Concrete

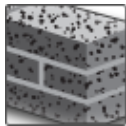

Solid brick

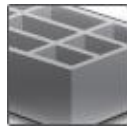

Hollow brick

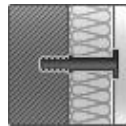

Insulation

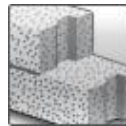
Autoclaved
aerated
concrete

Basic loading data (for a single anchor)

All data in this section applies to

- Correct setting (See setting instruction)
- No edge distance and spacing influence
- Base material as specified in the table
- Minimum base material thickness
- Tensile loads only

Recommended loads ^{a)}

		HIF
Concrete \geq C16/20	N_{rec} [kN]	0,03
Solid clay brick Mz 20 – 1,8 – NF	N_{rec} [kN]	0,03
Solid sand-lime brick KS 12 – 1,6 – 2DF	N_{rec} [kN]	0,03
Hollow clay brick ^{c)} Hlz 12 – 0,8 – 6DF	N_{rec} [kN]	0,025 ^{b)}
Hollow sand-lime brick ^{c)} KSL 12	N_{rec} [kN]	0,03
Autoclaved aerated concrete AAC 4	N_{rec} [kN]	0,02

a) Recommended loads N_{rec} are based on an global safety factor $\gamma = 5$ to the characteristic resistance. Design resistance N_{Rd} can be derived by multiplying N_{rec} with a partial safety factor of $\gamma_F = 1,4$.

b) Drilling without hammering

c) Thickness of web for Hlz \geq 18mm, for KSL \geq 25mm

Service temperature range

Hilti HIF insulation fastener may be applied in the temperature range given below.

Temperature range	Base material temperature	Maximum long term base material temperature	Maximum short term base material temperature
Temperature range	-40 °C to +40 °C	+24 °C	+40 °C

Max short term base material temperature

Short-term elevated base material temperatures are those that occur over brief intervals, e.g. as a result of diurnal cycling.

Max long term base material temperature

Long-term elevated base material temperatures are roughly constant over significant periods of time.

Materials

Material quality

Part	Material
Plastic sleeve	Polypropylene

Thermal parameters

Point thermal transmittance χ	0,000 W/K ^{a)}
------------------------------------	-------------------------

a) According EOTA Technical Report TR 025, the value 0,000 W/K may be taken, if the peak value of the point thermal transmittance χ in the considered range is smaller than 0,0005 W/K.

Setting

Installation equipment

Anchor size	HIF
Rotary hammer	TE2 ... TE16
Other tools	Hammer

Setting instruction

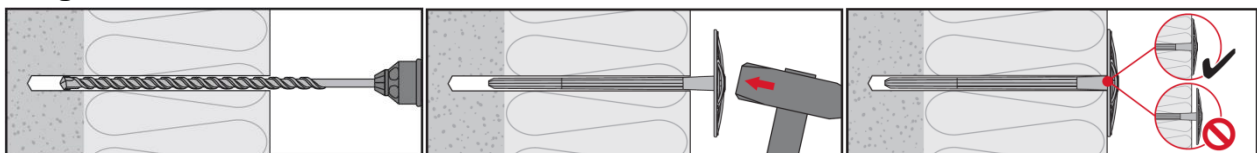

Drill hole with drill bit

Tap fastener with a hammer

Setting details: depth of drill hole h_1 and effective anchorage depth h_{ef}

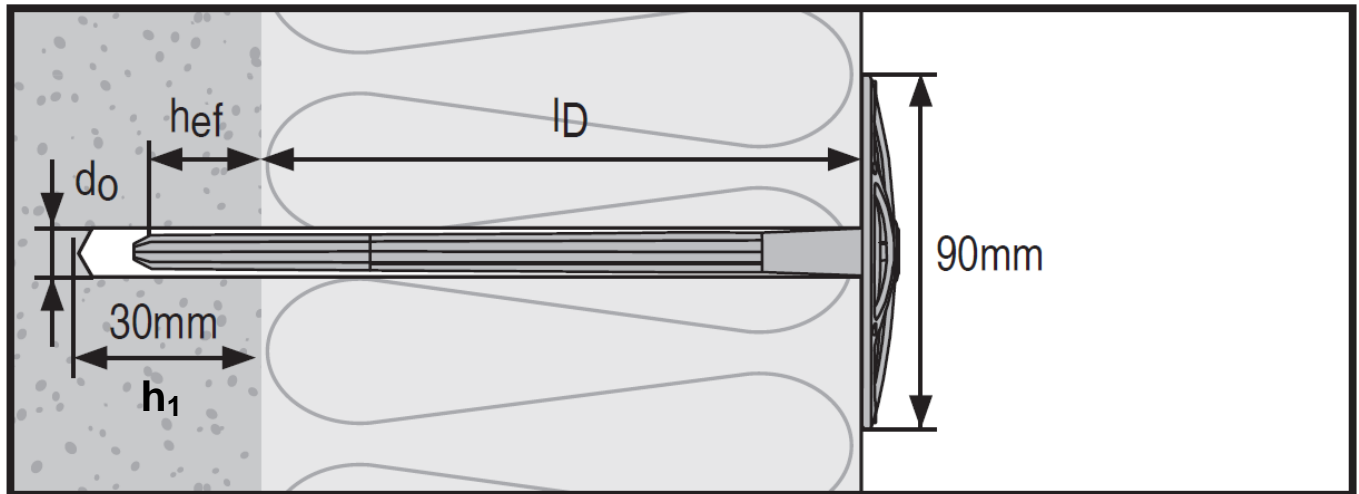

Setting details HIF

HIF		80	100	120	140	160	180	200	220	240
Nominal diameter of drill bit	$d_0 \leq$ [mm]	8								
Cutting diameter of drill bit	$d_{cut} \leq$ [mm]	8,45								
Depth of drill hole	h_1 [mm]	$l - l_D + 5$ ≥ 30								
Overall plastic anchor embedment depth in base material	$h_{nom} \geq$ [mm]	25								
Effective anchorage depth	$h_{ef} \geq$ [mm]	20								
Anchor length	l [mm]	105	125	145	165	185	205	225	245	265
Fixture thickness	l_D [mm]	60-80	80-100	100-120	120-140	140-160	160-180	180-200	200-220	220-240
Installation temperature	[°C]	0 to +40								

Setting parameters HIF

HIF		80	100	120	140	160	180	200	220	240
Minimum base material thickness	h_{min} [mm]	100								
Minimum spacing	s_{min} [mm]	100								
Minimum edge distance	c_{min} [mm]	100								

IDP Insulation fastener

Anchor version	Benefits
 <p>IDP</p>	<ul style="list-style-type: none"> - for insulating up to 15 cm - simple setting



Concrete

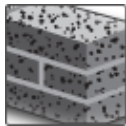

Solid brick

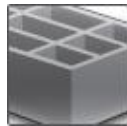

Hollow brick

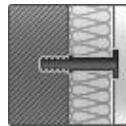

Insulation

Basic loading data (for a single anchor)

All data in this section applies to

- Correct setting (See setting instruction)
- No edge distance and spacing influence
- Base material as specified in the table
- Minimum base material thickness
- Loads shall be reduced and number of fasteners shall be increased if the temperature sustains above 40°C

Recommended loads ^{a)}

		IDP
Concrete \geq C16/20	N_{rec} [kN]	0,14
Solid clay brick Mz 20 – 1,8 – NF	N_{rec} [kN]	0,14
Solid sand-lime brick KS 12 – 1,6 – 2DF	N_{rec} [kN]	0,14
Hollow clay brick Hiz 12 – 0,8 – 6DF	N_{rec} [kN]	0,04 ^{b)}
Hollow sand-lime brick KSL 12 – 1,4 – 3DF	N_{rec} [kN]	0,04

a) With overall global safety factor $\gamma = 5$ to the characteristic loads and a partial safety factor of $\gamma = 1,4$ to the design values.

b) Drilling without hammering

Recommended number of IDP not regarding wind suction

			Number of fasteners per m ²
Expanded polystyrene (EPS) Polyurethane (PU)	density ≤ 40 kg/m ³	thickness ≤ 150 mm	4
Mineral wool	density ≤ 150 kg/m ³	thickness ≤ 100 mm	4
		thickness ≤ 150 mm	6

The data is only valid if no further material is applied on the insulation, e.g. plaster. Otherwise number of fasteners have to be increased.

Materials

Material quality

Part	Material
Plastic sleeve	Polypropylene

Setting

installation equipment

Anchor size	IDP
Rotary hammer	TE2 ... TE16
Other tools	Hammer

Setting instruction

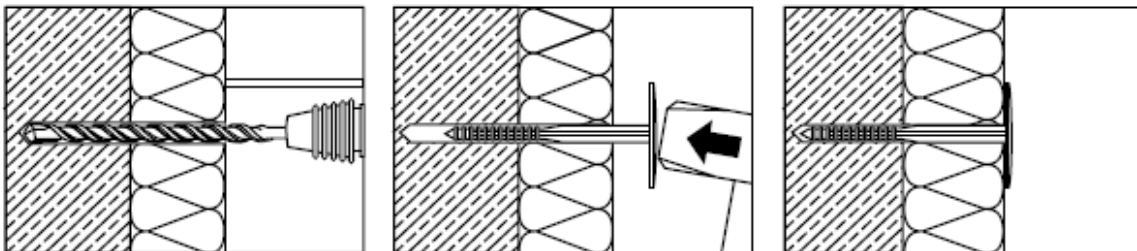

Drill hole with drill bit.

Tap in fastener with a hammer.

Setting details: depth of drill hole h_1 and effective anchorage depth h_{nom}

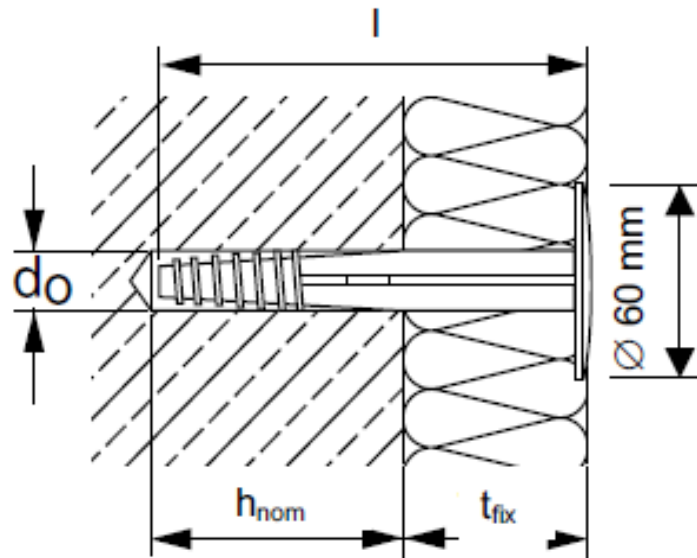

Setting details IDP

Anchor version IDP		0/2	2/4	4/6	6/8	8/10	10/12	13/15
Nominal diameter of drill bit	d_o [mm]	8						
Cutting diameter of drill bit	$d_{cut} \leq$ [mm]	8,45						
Depth of drill hole	$h_1 \geq$ [mm]	$l - t_{fix} + 10 \text{ mm} \geq 40 \text{ mm}$						
Effective anchorage depth	h_{nom} [mm]	25						
Anchor length	l [mm]	50	70	90	110	130	150	180
Max fixture thickness	t_{fix} [mm]	20	40	60	80	100	120	150
Installation temperature	[°C]	0 to +40						

IZ Insulation fastener

Anchor version	Benefits
<p>IZ</p>	<ul style="list-style-type: none"> - Insulation fastener esp. for plastered surfaces - 30mm setting depth - perfect flush setting

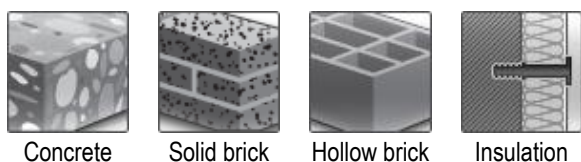

Basic loading data (for a single anchor)

All data in this section applies to

- Correct setting (See setting instruction)
- No edge distance and spacing influence
- Base material as specified in the table
- Minimum base material thickness

Recommended loads

		IZ
Concrete \geq C16/20	N_{rec} [kN]	0,2
Solid clay brick Mz 12 – 2,0	N_{rec} [kN]	0,2
Solid sand-lime brick KS 12 – 1,8	N_{rec} [kN]	0,2
Hollow clay brick Hlz 12 – 1,0	N_{rec} [kN]	0,13 ^{a)}
Hollow sand-lime brick KSL 12 – 1,4	N_{rec} [kN]	0,17

a) Drilling without hammering

Recommended pull-through loads and number of IZ in insulation

		IZ	
		Pull-through loads [kN]	Min. number of fasteners
Expanded polystyrene (EPS	thickness \geq 40 mm	0,15	5
Mineral wool, type HD	thickness \geq 40 mm	0,15	5
Mineral wool, type WV	thickness \geq 40 mm	0,15	4
Mineral wool, type lamella, with slip-on-plate HDT 140	thickness \geq 40 mm	0,167	4

Materials

Material quality

Part	Material
Anchor sleeve	Polypropylene
Expansion pin	Polyamide, fibre reinforced $\geq 50\%$,

Anchor dimensions

Anchor size			IZ
Minimum thickness of insulation	$h_{D,min}$	[mm]	0
Maximum thickness of insulation	$h_{D,max}$	[mm]	180
Diameter of the sleeve	d_{nom}	[mm]	8
Minimum length of the sleeve	$l_{1,min}$	[mm]	70
Maximum length of the sleeve	$l_{1,max}$	[mm]	210
Minimum length of the screw	$l_{2,min}$	[mm]	65
Maximum length of the screw	$l_{2,max}$	[mm]	205

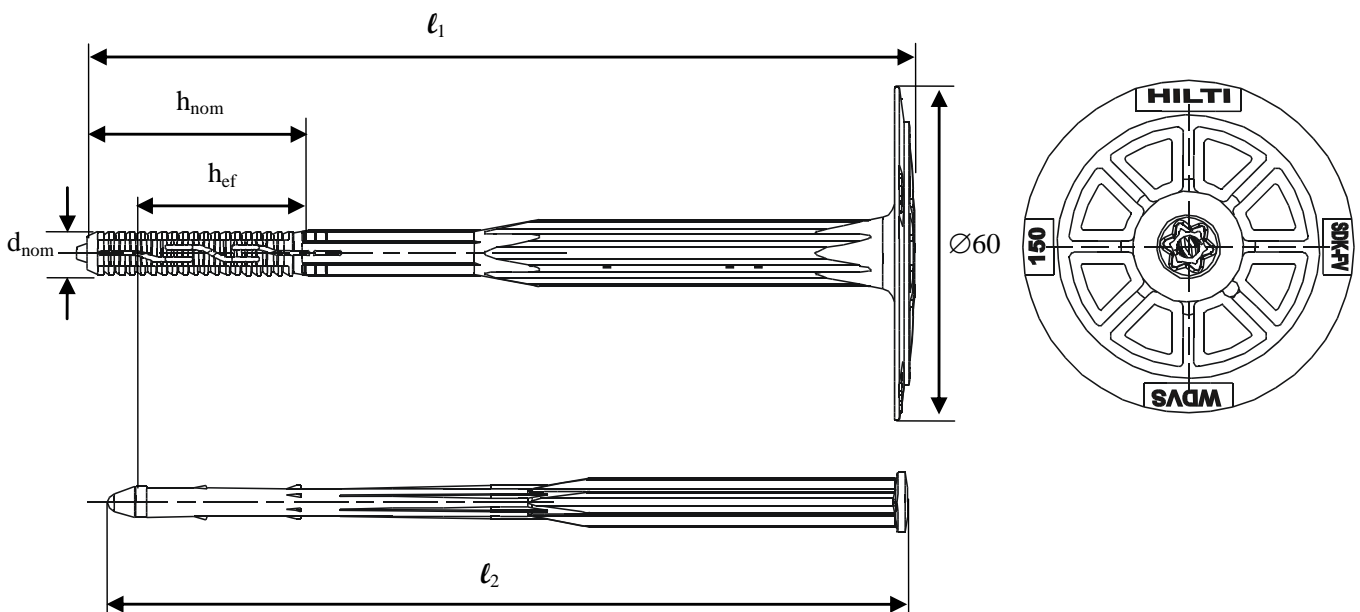

Setting

installation equipment

Anchor size	IDP
Rotary hammer	TE2 – TE16
Other tools	Hammer, stepped-drill TE-C 8/12-370 is necessary when $t_{tol} > 30mm$

Setting instruction

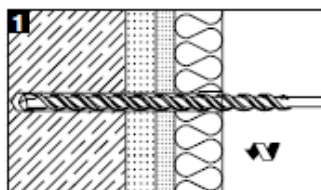

Drill hole with drill bit.

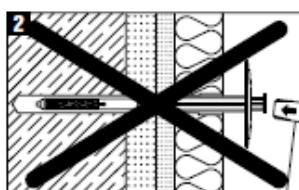
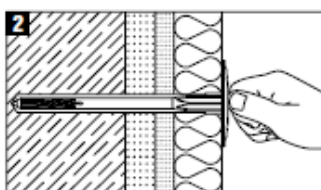

Tap in fastener body only.

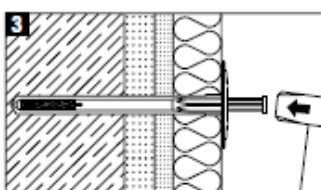

Hammer in expansion pin.

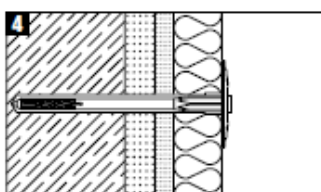

Setting details:

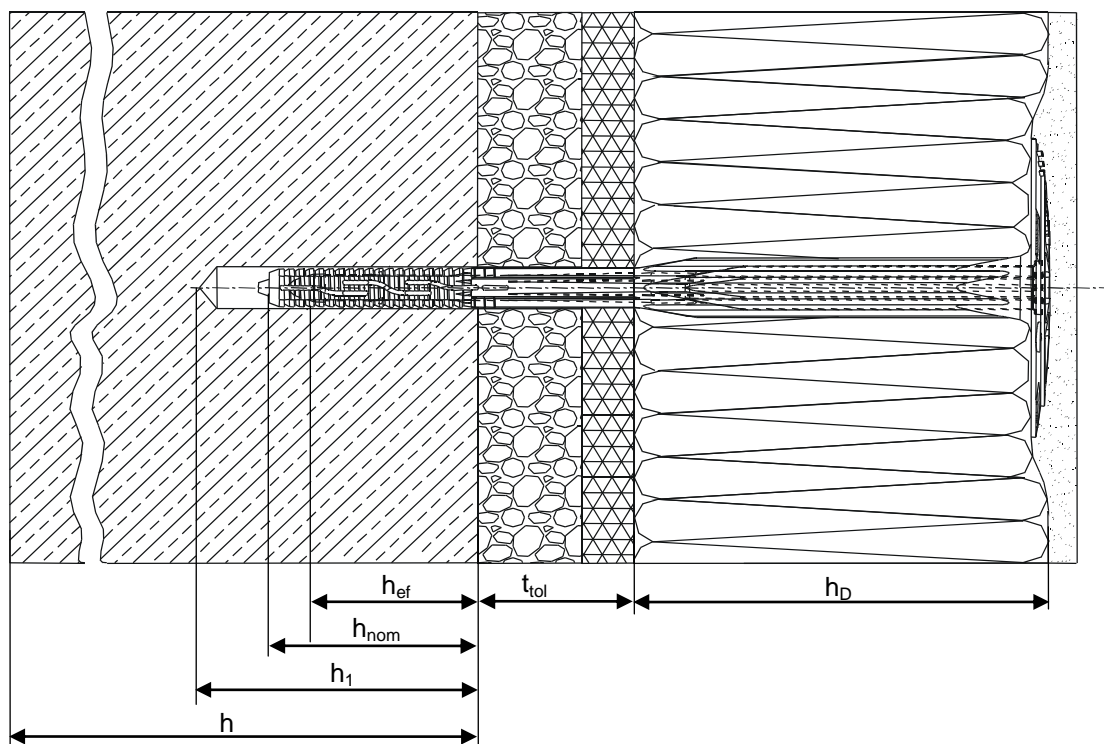

Setting details IZ

Anchor version		
Nominal diameter of drill bit	d_o [mm]	8
Cutting diameter of drill bit	$d_{cut} \leq$ [mm]	8,45
Depth of drill hole	$h_1 \geq$ [mm]	50
Effective anchorage depth	h_{ef} [mm]	30
Overall embedment depth	h_{nom} [mm]	40
Installation temperature	[°C]	0 to +40

Setting parameters

Anchor size		
Minimum base material thickness	h_{min} [mm]	100
Spacing	s_{min} [mm]	100
Edge distance	c_{min} [mm]	100

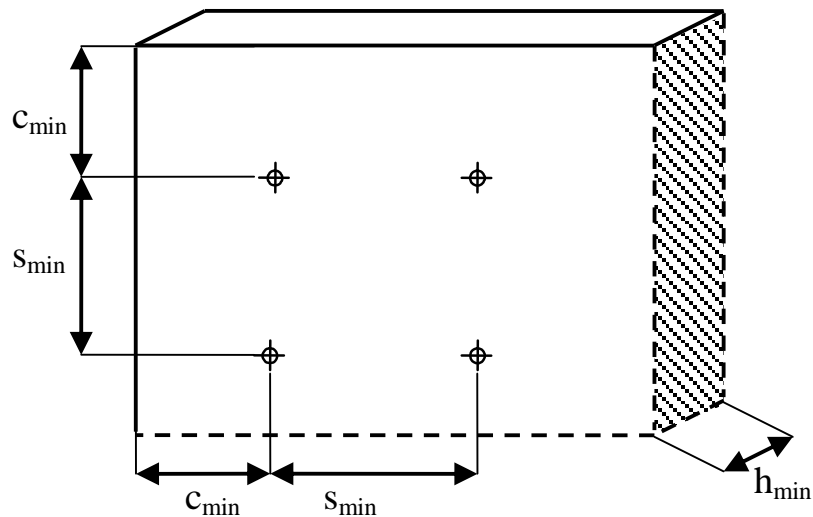

IDMS / IDMR Insulation fastener

Anchor version		Benefits
	IDMS Carbon steel	<ul style="list-style-type: none"> - for insulating material up to 15 cm thick - a non-flammable metal fastener - IDMS-T / IDMR-T insulation plate for non self-supporting insulation material
	IDMR Stainless steel	

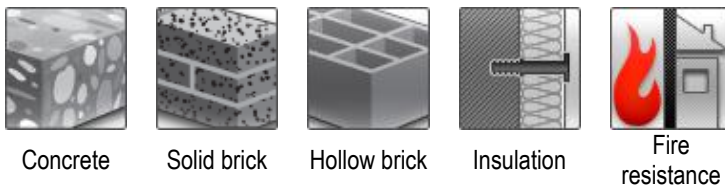

Concrete

Solid brick

Hollow brick

Insulation

Fire resistance

Approvals / certificates

Description	Authority / Laboratory	No. / date of issue
Fire test report	IBMB, Braunschweig	PB 3136/2315 / 2005-12-02

Basic loading data (for a single anchor)

All data in this section applies to

- Correct setting (See setting instruction)
- No edge distance and spacing influence
- Base material as specified in the table
- Minimum base material thickness
- Loads shall be reduced and number of fasteners shall be increased if the temperature sustains above 40°C

Recommended loads

		IDMS / IDMR
Concrete \geq C16/20	N_{rec} [kN]	0,1
Solid clay brick Mz 20 – 1,8 – NF	N_{rec} [kN]	0,1
Solid sand-lime brick KS 12 – 1,6 – 2DF	N_{rec} [kN]	0,1
Hollow clay brick Hz 12 – 0,8 – 6DF	N_{rec} [kN]	0,04 ^{a)}
Hollow sand-lime brick KSL 12 – 1,4 – 3DF	N_{rec} [kN]	0,04

a) Drilling without hammering

Recommended number of IDMS / IDMR not regarding wind suction

			Number of fasteners per m ²
Expanded polystyrene (EPS) Polyurethane (PU)	density ≤ 40 kg/m ³	thickness ≤ 150 mm	4
Mineral wool	density ≤ 150 kg/m ³	thickness ≤ 100 mm	6
		thickness ≤ 150 mm	8

The data is only valid if no further material is applied on the insulation, e.g. plaster. Otherwise number of fasteners has to be increased.

Materials

Material quality

Part	Material
IDMS	Carbon steel, galvanised to 16 µm
IDMR	Stainless steel, grade 1.4301

Setting

installation equipment

	IDMS / IDMR
Rotary hammer	TE2 – TE16
Other tools	Hammer

Setting instruction

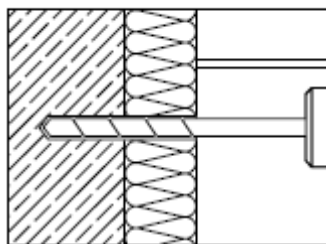

Drill hole with drill bit.

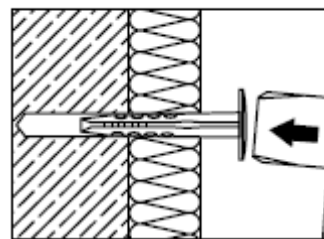

Install the fastener.

Setting details: depth of drill hole h_1 and effective anchorage depth h_{nom}

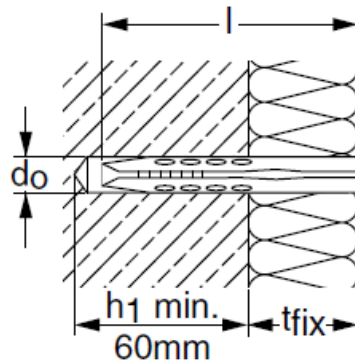

Setting details IDMS / IDMR

Anchor version IDMS / IDMR		0/3	3/6	6/9	9/12	12/15
Nominal diameter of drill bit	d_o [mm]	8				
Cutting diameter of drill bit	$d_{cut} \leq$ [mm]	8,45				
Depth of drill hole	$h_1 \geq$ [mm]	$l - t_{fix} + 10 \text{ mm} \geq 60\text{mm}$				
Effective anchorage depth	h_{nom} [mm]	$l - t_{fix} \geq 50$ 30 – 50		full load capacity load reduction with factor 0,5		
Anchor length	l [mm]	80	110	140	170	200
Max fixture thickness	t_{fix} [mm]	30	60	90	120	150

Setting parameters

Anchor size		
Minimum base material thickness	h_{min} [mm]	100
Spacing	s_{min} [mm]	100
Edge distance	c_{min} [mm]	100

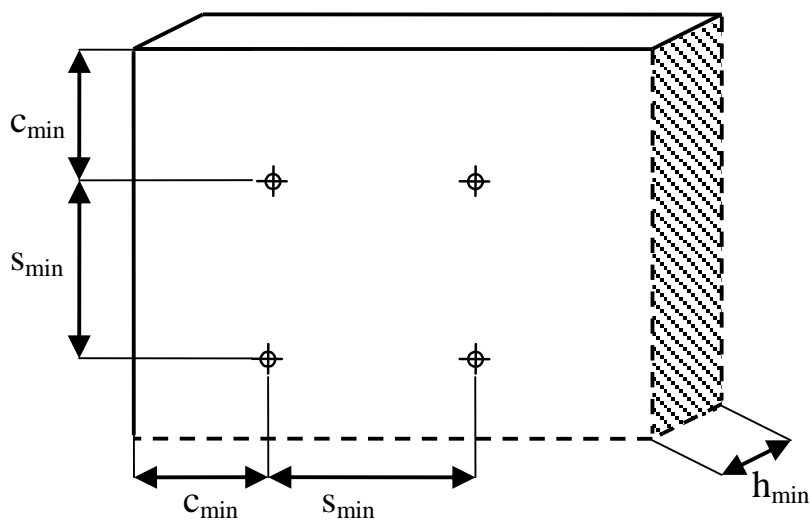











Adhesive anchoring systems

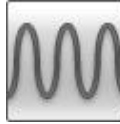

Adhesive capsule systems
Injection mortar systems

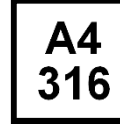

HVZ (HVU-TZ + HAS-TZ) adhesive anchor system

Mortar system	Benefits
 Hilti HVU-TZ foil capsule	- suitable for cracked and non-cracked concrete C 20/25 to C 50/60 - high loading capacity - suitable for dry and water saturated concrete
 HAS-TZ HAS-R-TZ HAS-HCR-TZ rod	

								
Concrete	Tensile zone	Fire resistance	Fatigue	Shock	Corrosion resistance	High corrosion resistance	European Technical Approval	CE conformity

		
European Technical Approval	CE conformity	PROFIS Anchor design software

Approvals / certificates

Description	Authority / Laboratory	No. / date of issue
European technical approval ^{a)}	DIBt, Berlin	ETA-03/0032 / 2013-06-04
Approval for shockproof fastenings in civil defence installations	Federal Office for Civil Protection, Bern	BZS D 09-602 / 2009-10-28
Fatigue loading	DIBt, Berlin	Z-21.3-1692 / 2013-07-19
Fire test report ZTV-Tunnel	IBMB, Braunschweig	UB 3357/0550-2 / 2001-06-26
Fire test report	IBMB, Brunswick	UB 3357/0550-1 / 2001-04-17
Assessment report (fire)	warringtonfire	WF 327804/B / 2013-07-10

a) All data given in this section according ETA-03/0032, issue 2013-06-04.

Basic loading data (for a single anchor)

All data in this section applies to

- Correct setting (See setting instruction)
- No edge distance and spacing influence
- Steel failure
- Base material thickness, as specified in the table
- Embedment depth, as specified in the table
- One anchor material, as specified in the tables
- Concrete C 20/25, $f_{ck,cube} = 25 \text{ N/mm}^2$
- Temperature range I
(min. base material temperature -40°C , max. long term/short term base material temperature: $+50^\circ\text{C}/80^\circ\text{C}$)
- Installation temperature range 0°C to $+40^\circ\text{C}$

For details see Simplified design method

Embedment depth and base material thickness for the basic loading data.
Mean ultimate resistance, characteristic resistance, design resistance, recommended loads.

Anchor size	M10x75	M12x95	M16x105	M16x125	M20x170
Embedment depth [mm]	75	95	105	125	170
Base material thickness [mm]	150	190	210	250	340

Mean ultimate resistance ^{a)}: concrete C 20/25 – $f_{ck,cube} = 25 \text{ N/mm}^2$, anchor HVZ

Data according ETA-03/0032, issue 2013-06-04							
Anchor size			M10x75	M12x95	M16x105	M16x125	M20x170
Non cracked concrete							
Tensile $N_{Ru,m}$	HVZ	[kN]	36,8	53,3	72,4	94,1	149,2
Shear $V_{Ru,m}$	HVZ	[kN]	18,9	28,4	53,6	53,6	92,4
Cracked concrete							
Tensile $N_{Ru,m}$	HVZ	[kN]	31,2	44,4	51,6	67,1	106,4
Shear $V_{Ru,m}$	HVZ	[kN]	18,9	28,4	53,6	53,6	92,4

Characteristic resistance: concrete C 20/25 – $f_{ck,cube} = 25 \text{ N/mm}^2$, anchor HVZ

Data according ETA-03/0032, issue 2013-06-04							
Anchor size			M10x75	M12x95	M16x105	M16x125	M20x170
Non cracked concrete							
Tensile N_{Rk}	HVZ	[kN]	32,8	40,0	54,3	70,6	111,9
Shear V_{Rk}	HVZ	[kN]	18,0	27,0	51,0	51,0	88,0
Cracked concrete							
Tensile N_{Rk}	HVZ	[kN]	23,4	33,3	38,7	50,3	79,8
Shear V_{Rk}	HVZ	[kN]	18,0	27,0	51,0	51,0	88,0

Design resistance: concrete C 20/25 – $f_{ck,cube} = 25 \text{ N/mm}^2$, anchor HVZ

Data according ETA-03/0032, issue 2013-06-04							
Anchor size			M10x75	M12x95	M16x105	M16x125	M20x170
Non cracked concrete							
Tensile N_{Rd}	HVZ	[kN]	21,9	26,7	36,2	47,1	74,6
Shear V_{Rd}	HVZ	[kN]	14,4	21,6	40,8	40,8	70,4
Cracked concrete							
Tensile N_{Rd}	HVZ	[kN]	15,6	22,2	25,8	33,5	53,2
Shear V_{Rd}	HVZ	[kN]	14,4	21,6	40,8	40,8	70,4

Recommended loads ^{a)}: concrete C 20/25 – $f_{ck,cube} = 25 \text{ N/mm}^2$, anchor HVZ

Data according ETA-03/0032, issue 2013-06-04							
Anchor size			M10x75	M12x95	M16x105	M16x125	M20x170
Non cracked concrete							
Tensile N_{rec}	HVZ	[kN]	15,6	19,0	25,9	33,6	53,3
Shear V_{rec}	HVZ	[kN]	10,3	15,4	29,1	29,1	50,3
Cracked concrete							
Tensile N_{rec}	HVZ	[kN]	11,1	15,9	18,4	24,0	38,0
Shear V_{rec}	HVZ	[kN]	10,3	15,4	29,1	29,1	50,3

a) With overall partial safety factor for action $\gamma = 1,4$. The partial safety factors for action depend on the type of loading and shall be taken from national regulations.

Service temperature range

Hilti HVZ adhesive anchor with anchor rod HAS-TZ may be applied in the temperature ranges given below. An elevated base material temperature may lead to a reduction of the design bond resistance.

Temperature range	Base material temperature	Maximum long term base material temperature	Maximum short term base material temperature
Temperature range I	-40 °C to +80 °C	+50 °C	+80 °C

Max short term base material temperature

Short-term elevated base material temperatures are those that occur over brief intervals, e.g. as a result of diurnal cycling.

Max long term base material temperature

Long-term elevated base material temperatures are roughly constant over significant periods of time.

Materials

Mechanical properties of HAS-TZ

			Data according ETA-03/0032, issue 2013-06-04				
Anchor size			M10x75	M12x95	M16x105	M16x125	M20x170
Nominal tensile strength f_{uk}	HAS-(R) (HCR)TZ	[N/mm ²]	800				
Yield strength f_{yk}	HAS-(R) (HCR)TZ	[N/mm ²]	640				
Stressed cross-section A_s	tension	[mm ²]	44,2	63,6	113	113	227
	shear	[mm ²]	50,3	73,9	141	141	245
Moment of resistance W	HAS-(R) (HCR)TZ	[mm ³]	50,3	89,6	236	236	541

Material quality

Part	Material
HAS-TZ	carbon steel strength class 8.8
HAS-R-TZ	stainless steel 1.4401 and 1.4571
HAS-HCR-TZ	high corrosion resistance steel 1.4529 and 1.4547

Anchor dimensions

Anchor size	M10x75	M12x95	M16x105	M16x125	M20x170
Anchor embedment depth [mm]	75	95	105	125	170

Setting

installation equipment

Anchor size	M10x75	M12x95	M16x105	M16x125	M20x170
Rotary hammer	TE 1 – TE 30		TE 1 – TE 60		TE 30 – TE 80
Tools	Setting tools				

Setting instruction

Dry and water-saturated concrete, hammer drilling

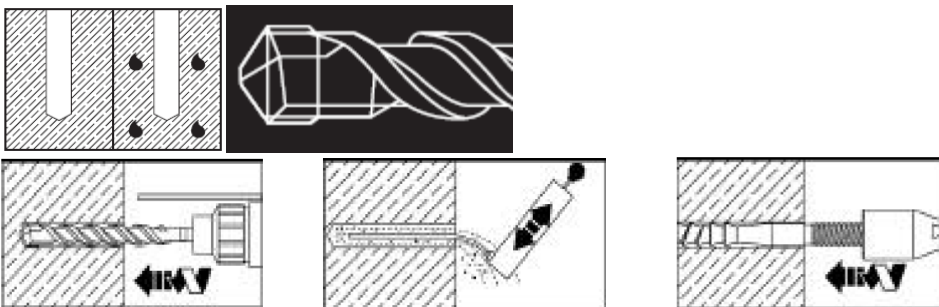

For detailed information on installation see instruction for use given with the package of the product.

For technical data for anchors in diamond drilled holes please contact the Hilti Technical advisory service.

Curing time for general conditions

Data according ETA-03/0032, issue 2013-06-04	
Temperature of the base material	Curing time before anchor can be fully loaded t_{cure}
$\geq 20\text{ °C}$	20 min
10 °C to 20 °C	30 min
0 °C to 10 °C	60 min

These data are valid for dry concrete only. In wet concrete the curing time must be doubled.

Setting details

		Data according ETA-03/0032, issue 2013-06-04				
Anchor size		M10x75	M12x95	M16x105	M16x125	M20x170
Nominal diameter of drill bit	d_0 [mm]	12	14	18	18	25
Diameter of element	d [mm]	10	12	16	16	20
Effective anchorage depth	h_{ef} [mm]	75	95	105	125	170
Drill hole depth	h_1 [mm]	90	110	125	145	195
Minimum base material thickness	$h_{min}^a)$ [mm]	150	190	210	250	340
Diameter of clearance hole in the fixture	d_f [mm]	12	14	18	18	22
Cracked concrete						
Minimum spacing	s_{min} [mm]	50	60	70	70	80
Minimum edge distance	c_{min} [mm]	50	60	70	70	80
Non cracked concrete						
Minimum spacing	s_{min} [mm]	50	60	70	70	80
Minimum edge distance	c_{min} [mm]	50	70	85	85	80
Critical spacing for splitting failure	$s_{cr,sp}$ [mm]	$2 c_{cr,sp}$				
Critical edge distance for splitting failure	$c_{cr,sp}$ [mm]	$1,5 h_{ef}$				
Critical spacing for concrete cone failure	$s_{cr,N}$	$2 c_{cr,N}$				
Critical edge distance for concrete cone failure	$c_{cr,N}^b)$	$1,5 h_{ef}$				
Torque moment ^{c)}	T_{max} [Nm]	40	50	90	90	150

For spacing (edge distance) smaller than critical spacing (critical edge distance) the design loads have to be reduced.

- a) h : base material thickness ($h \geq h_{min}$)
- b) The critical edge distance for concrete cone failure depends on the embedment depth h_{ef} and the design bond resistance. The simplified formula given in this table is on the save side.
- c) This is the maximum recommended torque moment to avoid splitting failure during installation for anchors with minimum spacing and/or edge distance.

Simplified design method

Simplified version of the design method according ETAG 001, Annex C. Design resistance according data given in ETA-03/0032, issue 2013-06-04.

- Influence of concrete strength
- Influence of edge distance
- Influence of spacing
- Valid for a group of two anchors. (The method may also be applied for anchor groups with more than two anchors or more than one edge distance. The influencing factors must then be considered for each edge distance and spacing. The calculated design loads are then on the save side: They will be lower than the exact values according ETAG 001, Annex C. To avoid this, it is recommended to use the anchor design software PROFIS anchor)

The design method is based on the following simplification:

- No different loads are acting on individual anchors (no eccentricity)

The values are valid for one anchor.

For more complex fastening applications please use the anchor design software PROFIS Anchor.

Tension loading

The design tensile resistance is the lower value of

- Steel resistance: $N_{Rd,s}$
- Combined pull-out and concrete cone resistance: $N_{Rd,p} = N_{Rd,p}^0 \cdot f_{B,p} \cdot f_{h,p}$
- Concrete cone resistance: $N_{Rd,c} = N_{Rd,c}^0 \cdot f_B \cdot f_{1,N} \cdot f_{2,N} \cdot f_{3,N} \cdot f_{h,N} \cdot f_{re,N}$
- Concrete splitting resistance (only non-cracked concrete): $N_{Rd,sp} = N_{Rd,c}^0 \cdot f_B \cdot f_{1,sp} \cdot f_{2,sp} \cdot f_{3,sp} \cdot f_{h,sp} \cdot f_{re,N}$

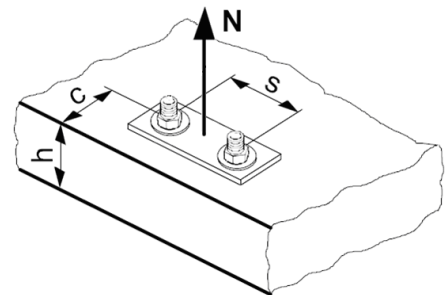

Basic design tensile resistance

Design steel resistance $N_{Rd,s}$

		Data according ETA-03/0032, issue 2013-06-04				
Anchor size		M10x75	M12x95	M16x105	M16x125	M20x170
$N_{Rd,s}$	HAS-TZ HAS-R-TZ HAS-HCR-TZ [kN]	23,3	34,0	60,0	60,0	121,3

Design combined pull-out and concrete cone resistance $N_{Rd,p} = N_{Rd,p}^0 \cdot f_{B,p} \cdot f_{h,p}$

		Data according ETA-03/0032, issue 2013-06-04				
Anchor size		M10x75	M12x95	M16x105	M16x125	M20x170
Embedment depth h_{ef} [mm]		75	95	105	125	170
Non cracked concrete						
$N_{Rd,p}^0$	Temperature range I [kN]	21,9	26,7	36,2	47,1	74,6
Cracked concrete						
$N_{Rd,p}^0$	Temperature range I [kN]	15,6	22,2	25,8	33,5	53,2

Design concrete cone resistance $N_{Rd,c} = N_{Rd,c}^0 \cdot f_B \cdot f_{1,N} \cdot f_{2,N} \cdot f_{3,N} \cdot f_{h,N} \cdot f_{re,N}$

Design splitting resistance ^{a)} $N_{Rd,sp} = N_{Rd,c}^0 \cdot f_B \cdot f_{h,N} \cdot f_{1,sp} \cdot f_{2,sp} \cdot f_{3,sp} \cdot f_{re,N}$

		Data according ETA-03/0032, issue 2013-06-04				
Anchor size		M10x75	M12x95	M16x105	M16x125	M20x170
$N_{Rd,c}^0$	Non cracked concrete [kN]	21,9	31,2	36,2	47,1	74,6
$N_{Rd,c}^0$	Cracked concrete [kN]	15,6	22,2	25,8	33,5	53,2

a) Splitting resistance must only be considered for non-cracked concrete

Influencing factors

Influence of concrete strength on combined pull-out and concrete cone resistance

Concrete strength designation (ENV 206)	C 20/25	C 25/30	C 30/37	C 35/45	C 40/50	C 45/55	C 50/60
$f_{B,p} = (f_{ck,cube}/25N/mm^2)^{0.1}$ ^{a)}	1	1,02	1,04	1,06	1,07	1,08	1,09

a) $f_{ck,cube}$ = concrete compressive strength, measured on cubes with 150 mm side length

Influence of embedment depth on combined pull-out and concrete cone resistance

$f_{h,p} = h_{ef}/h_{ef,typ}$

Influence of concrete strength on concrete cone resistance

Concrete strength designation (ENV 206)	C 20/25	C 25/30	C 30/37	C 35/45	C 40/50	C 45/55	C 50/60
$f_B = (f_{ck,cube}/25N/mm^2)^{1/2}$ ^{a)}	1	1,1	1,22	1,34	1,41	1,48	1,55

a) $f_{ck,cube}$ = concrete compressive strength, measured on cubes with 150 mm side length

Influence of edge distance ^{a)}

$c/c_{cr,N}$	0,1	0,2	0,3	0,4	0,5	0,6	0,7	0,8	0,9	1
$c/c_{cr,sp}$										
$f_{1,N} = 0,7 + 0,3 \cdot c/c_{cr,N} \leq 1$	0,73	0,76	0,79	0,82	0,85	0,88	0,91	0,94	0,97	1
$f_{1,sp} = 0,7 + 0,3 \cdot c/c_{cr,sp} \leq 1$										
$f_{2,N} = 0,5 \cdot (1 + c/c_{cr,N}) \leq 1$	0,55	0,60	0,65	0,70	0,75	0,80	0,85	0,90	0,95	1
$f_{2,sp} = 0,5 \cdot (1 + c/c_{cr,sp}) \leq 1$										

a) The edge distance shall not be smaller than the minimum edge distance c_{min} given in the table with the setting details. These influencing factors must be considered for every edge distance.

Influence of anchor spacing ^{a)}

$s/s_{cr,N}$	0,1	0,2	0,3	0,4	0,5	0,6	0,7	0,8	0,9	1
$s/s_{cr,sp}$										
$f_{3,N} = 0,5 \cdot (1 + s/s_{cr,N}) \leq 1$	0,55	0,60	0,65	0,70	0,75	0,80	0,85	0,90	0,95	1
$f_{3,sp} = 0,5 \cdot (1 + s/s_{cr,sp}) \leq 1$										

a) The anchor spacing shall not be smaller than the minimum anchor spacing s_{min} given in the table with the setting details. This influencing factor must be considered for every anchor spacing.

Influence of embedment depth on concrete cone resistance

$f_{h,N} = (h_{ef}/h_{ef,typ})^{1,5}$

Influence of reinforcement

h_{ef} [mm]	40	50	60	70	80	90	≥ 100
$f_{re,N} = 0,5 + h_{ef}/200\text{mm} \leq 1$	0,7 ^{a)}	0,75 ^{a)}	0,8 ^{a)}	0,85 ^{a)}	0,9 ^{a)}	0,95 ^{a)}	1

a) This factor applies only for dense reinforcement. If in the area of anchorage there is reinforcement with a spacing ≥ 150 mm (any diameter) or with a diameter ≤ 10 mm and a spacing ≥ 100 mm, then a factor $f_{re} = 1$ may be applied.

Shear loading

The design shear resistance is the lower value of

- Steel resistance: $V_{Rd,s}$
- Concrete pryout resistance: $V_{Rd,cp} = k \cdot \text{lower value of } N_{Rd,p} \text{ and } N_{Rd,c}$
- Concrete edge resistance: $V_{Rd,c} = V_{Rd,c}^0 \cdot f_B \cdot f_h \cdot f_4$

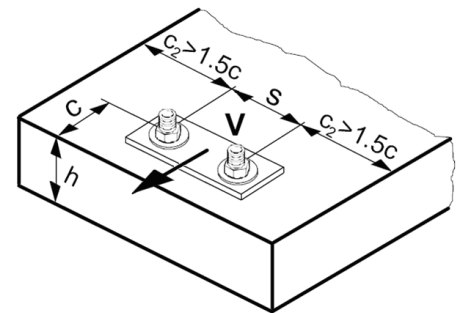

Basic design shear resistance

Design steel resistance $V_{Rd,s}$

		Data according ETA-03/0032, issue 2013-06-04				
Anchor size		M10x75	M12x95	M16x105	M16x125	M20x170
$V_{Rd,s}$	HAS-TZ [kN]	14,4	21,6	40,8	40,8	70,4
$V_{Rd,s}$	HAS-R-TZ HAS-HCR-TZ [kN]	16,0	24,0	44,8	44,8	78,4

Design concrete pryout resistance $V_{Rd,cp} = \text{lower value}^a)$ of $k \cdot N_{Rd,p}$ and $k \cdot N_{Rd,c}$

$$k = 1 \text{ for } h_{ef} < 60 \text{ mm}$$

$$k = 2 \text{ for } h_{ef} \geq 60 \text{ mm}$$

- a) $N_{Rd,p}$: Design combined pull-out and concrete cone resistance
 $N_{Rd,c}$: Design concrete cone resistance

Design concrete edge resistance $V_{Rd,c} = V_{Rd,c}^0 \cdot f_B \cdot f_h \cdot f_4$

		Non-cracked concrete					Cracked concrete				
Anchor size		M10x 75	M12x 95	M16x 105	M16x 125	M20x 170	M10x 75	M12x 95	M16x 105	M16x 125	M20x 170
$V_{Rd,c}^0$	[kN]	3,7	6,7	9,9	10,3	11,0	2,7	3,8	5,3	5,5	7,9

- a) For anchor groups only the anchors close to the edge must be considered.

Influencing factors

Influence of concrete strength

Concrete strength designation (ENV 206)	C 20/25	C 25/30	C 30/37	C 35/45	C 40/50	C 45/55	C 50/60
$f_B = (f_{ck,cube}/25\text{N/mm}^2)^{1/2}$ a)	1	1,1	1,22	1,34	1,41	1,48	1,55

- a) $f_{ck,cube}$ = concrete compressive strength, measured on cubes with 150 mm side length

Influence of angle between load applied and the direction perpendicular to the free edge

Angle β	0°	10°	20°	30°	40°	50°	60°	70°	80°	≥ 90°
$f_{\beta} = \frac{1}{\sqrt{(\cos \alpha_v)^2 + \left(\frac{\sin \alpha_v}{2,5}\right)^2}}$	1	1,01	1,05	1,13	1,24	1,40	1,64	1,97	2,32	2,50

Influence of base material thickness

h/c	0,15	0,3	0,45	0,6	0,75	0,9	1,05	1,2	1,35	≥ 1,5
$f_h = \{h/(1,5 \cdot c)\}^{2/3} \leq 1$	0,22	0,34	0,45	0,54	0,63	0,71	0,79	0,86	0,93	1,00

Influence of anchor spacing and edge distance ^{a)} for concrete edge resistance: f_4

$$f_4 = (c/h_{ef})^{1,5} \cdot (1 + s / [3 \cdot c]) \cdot 0,5$$

c/h _{ef}	Single anchor	Group of two anchors s/h _{ef}														
		0,75	1,50	2,25	3,00	3,75	4,50	5,25	6,00	6,75	7,50	8,25	9,00	9,75	10,50	11,25
0,50	0,35	0,27	0,35	0,35	0,35	0,35	0,35	0,35	0,35	0,35	0,35	0,35	0,35	0,35	0,35	0,35
0,75	0,65	0,43	0,54	0,65	0,65	0,65	0,65	0,65	0,65	0,65	0,65	0,65	0,65	0,65	0,65	0,65
1,00	1,00	0,63	0,75	0,88	1,00	1,00	1,00	1,00	1,00	1,00	1,00	1,00	1,00	1,00	1,00	1,00
1,25	1,40	0,84	0,98	1,12	1,26	1,40	1,40	1,40	1,40	1,40	1,40	1,40	1,40	1,40	1,40	1,40
1,50	1,84	1,07	1,22	1,38	1,53	1,68	1,84	1,84	1,84	1,84	1,84	1,84	1,84	1,84	1,84	1,84
1,75	2,32	1,32	1,49	1,65	1,82	1,98	2,15	2,32	2,32	2,32	2,32	2,32	2,32	2,32	2,32	2,32
2,00	2,83	1,59	1,77	1,94	2,12	2,30	2,47	2,65	2,83	2,83	2,83	2,83	2,83	2,83	2,83	2,83
2,25	3,38	1,88	2,06	2,25	2,44	2,63	2,81	3,00	3,19	3,38	3,38	3,38	3,38	3,38	3,38	3,38
2,50	3,95	2,17	2,37	2,57	2,77	2,96	3,16	3,36	3,56	3,76	3,95	3,95	3,95	3,95	3,95	3,95
2,75	4,56	2,49	2,69	2,90	3,11	3,32	3,52	3,73	3,94	4,15	4,35	4,56	4,56	4,56	4,56	4,56
3,00	5,20	2,81	3,03	3,25	3,46	3,68	3,90	4,11	4,33	4,55	4,76	4,98	5,20	5,20	5,20	5,20
3,25	5,86	3,15	3,38	3,61	3,83	4,06	4,28	4,51	4,73	4,96	5,18	5,41	5,63	5,86	5,86	5,86
3,50	6,55	3,51	3,74	3,98	4,21	4,44	4,68	4,91	5,14	5,38	5,61	5,85	6,08	6,31	6,55	6,55
3,75	7,26	3,87	4,12	4,36	4,60	4,84	5,08	5,33	5,57	5,81	6,05	6,29	6,54	6,78	7,02	7,26
4,00	8,00	4,25	4,50	4,75	5,00	5,25	5,50	5,75	6,00	6,25	6,50	6,75	7,00	7,25	7,50	7,75
4,25	8,76	4,64	4,90	5,15	5,41	5,67	5,93	6,18	6,44	6,70	6,96	7,22	7,47	7,73	7,99	8,25
4,50	9,55	5,04	5,30	5,57	5,83	6,10	6,36	6,63	6,89	7,16	7,42	7,69	7,95	8,22	8,49	8,75
4,75	10,35	5,45	5,72	5,99	6,27	6,54	6,81	7,08	7,36	7,63	7,90	8,17	8,45	8,72	8,99	9,26
5,00	11,18	5,87	6,15	6,43	6,71	6,99	7,27	7,55	7,83	8,11	8,39	8,66	8,94	9,22	9,50	9,78
5,25	12,03	6,30	6,59	6,87	7,16	7,45	7,73	8,02	8,31	8,59	8,88	9,17	9,45	9,74	10,02	10,31
5,50	12,90	6,74	7,04	7,33	7,62	7,92	8,21	8,50	8,79	9,09	9,38	9,67	9,97	10,26	10,55	10,85

a) The anchor spacing and the edge distance shall not be smaller than the minimum anchor spacing s_{min} and the minimum edge distance c_{min} .

Combined tension and shear loading

For combined tension and shear loading see section "Anchor Design".



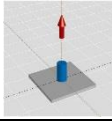
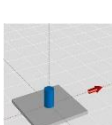
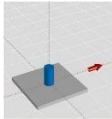

Precalculated values

Recommended loads can be calculated by dividing the design resistance by an overall partial safety factor for action $\gamma = 1,4$. The partial safety factors for action γ depend on the type of loading and shall be taken from national regulations.

Design resistance: concrete C 20/25 – $f_{ck,cube} = 25 \text{ N/mm}^2$

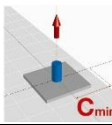
		Data according ETA-03/0032, issue 2013-06-04					
Anchor size		M10x75	M12x95	M16x105	M16x125	M20x170	
Embedment depth	$h_{ef} = [\text{mm}]$	75	95	105	125	170	
Base material thickness	$h_{min} = [\text{mm}]$	150	190	210	250	340	
Tensile N_{Rd}: single anchor, no edge effects							
Non cracked concrete							
	HVZ						
	HVZ-R	[kN]	21,9	26,7	36,2	47,1	74,6
	HVZ-HCR						
Cracked concrete							
	HVZ						
	HVZ-R	[kN]	15,6	22,2	25,8	33,5	53,2
	HVZ-HCR						
Shear V_{Rd}: single anchor, no edge effects, without lever arm							
Non cracked and cracked concrete							
	HVZ	[kN]	14,4	21,6	40,8	40,8	70,4
	HVZ-R	[kN]	16,0	24,0	44,8	44,8	78,4
	HVZ-HCR						

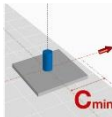

Design resistance: concrete C 20/25 – $f_{ck,cube} = 25 \text{ N/mm}^2$

		Data according ETA-03/0032, issue 2013-06-04					
Anchor size		M10x75	M12x95	M16x105	M16x125	M20x170	
Embedment depth	$h_{ef} = [\text{mm}]$	75	95	105	125	170	
Base material thickness	$h_{min} = [\text{mm}]$	150	190	210	250	340	
Tensile N_{Rd}: single anchor, min. edge distance ($c = c_{min}$)							
Non cracked concrete							
	c_{min}	[mm]	50	70	85	85	80
	HVZ						
	HVZ-R	[kN]	13,2	15,7	21,8	26,2	38,9
	HVZ-HCR						
	Cracked concrete						
	c_{min}	[mm]	50	60	70	70	80
	HVZ						
	HVZ-R	[kN]	9,4	14,0	17,1	20,4	27,7
	HVZ-HCR						
Shear V_{Rd}: single anchor, min. edge distance ($c = c_{min}$), without lever arm							
Non cracked concrete							
	c_{min}	[mm]	50	70	85	85	80
	HVZ						
	HVZ-R	[kN]	3,5	5,1	7,2	7,4	10,3
	HVZ-HCR						
	Cracked concrete						
	c_{min}	[mm]	50	60	70	70	80
	HVZ						
	HVZ-R	[kN]	2,5	4,6	6,9	7,1	7,4
	HVZ-HCR						

Design resistance: concrete C 20/25 – $f_{ck,cube} = 25 \text{ N/mm}^2$
(load values are valid for single anchor)

		Data according ETA-03/0032, issue 2013-06-04					
Anchor size		M10x75	M12x95	M16x105	M16x125	M20x170	
Embedment depth	$h_{ef} =$ [mm]	75	95	105	125	170	
Base material thickness	$h_{min} =$ [mm]	150	190	210	250	340	
Spacing	$s = s_{min} =$ [mm]	50	60	70	70	80	
Tensile N_{Rd}: double anchor, no edge effects, min. spacing ($s = s_{min}$)							
Non cracked concrete							
	Tensile N_{Rd}: double anchor, no edge effects, min. spacing ($s = s_{min}$)						
	Non cracked concrete						
	HVZ						
	HVZ-R	[kN]	13,4	16,1	22,1	27,9	43,2
	HVZ-HCR						
	Cracked concrete						
HVZ							
HVZ-R	[kN]	9,5	13,5	15,8	19,9	30,8	
HVZ-HCR							
Shear V_{Rd}: double anchor, no edge effects, min. spacing ($s = s_{min}$), without lever arm							
Non cracked concrete							
	Shear V_{Rd}: double anchor, no edge effects, min. spacing ($s = s_{min}$), without lever arm						
	Non cracked concrete						
	HVZ	[kN]	14,4	21,6	40,8	40,8	70,4
	HVZ-R	[kN]	16,0	24,0	44,3	44,8	78,4
	HVZ-HCR						
	Cracked concrete						
HVZ	[kN]	14,4	21,6	31,6	39,8	61,5	
HVZ-R	[kN]	16,0	24,0	31,6	39,8	61,5	
HVZ-HCR							

HVU with HAS/HAS-E rod adhesive anchor system

Mortar system	Benefits
 <p>Hilti HVU foil capsule</p>	<ul style="list-style-type: none"> - suitable for non-cracked concrete C 20/25 to C 50/60 - high loading capacity - suitable for dry and water saturated concrete - large diameter applications - high corrosion resistant
 <p>HAS HAS-R HAS-HCR rod</p>	
 <p>HAS-E HAS-E R HAS-E HCR rod</p>	



Concrete

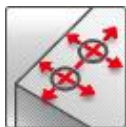

Small edge distance and spacing



Fire resistance

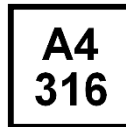

Corrosion resistance



High corrosion resistance



European Technical Approval



CE conformity



PROFIS Anchor design software

Approvals / certificates

Description	Authority / Laboratory	No. / date of issue
European technical approval ^{a)}	DIBt, Berlin	ETA-05/0255 / 2011-06-23
Fire test report	IBMB, Braunschweig	UB-3333/0891-1 / 2004-03-26
Fire test report ZTV-Tunnel	IBMB, Braunschweig	UB 3333/0891-2 / 2003-08-12
Assessment report (fire)	warringtonfire	WF 327804/B / 2013-07-10

a) All data given in this section according

ETA-05/0255, issue 2011-06-23

Basic loading data (for a single anchor)

All data in this section applies to

For details see Simplified design method

- Correct setting (See setting instruction)
- No edge distance and spacing influence
- Steel failure
- Base material thickness, as specified in the table
- One typical embedment depth, as specified in the table
- One anchor material, as specified in the tables
- Concrete C 20/25, $f_{ck,cube} = 25 \text{ N/mm}^2$
- Temperate range I
(min. base material temperature -40°C , max. long term/short term base material temperature: $+24^\circ\text{C}/40^\circ\text{C}$)
- Installation temperature range -5°C to $+40^\circ\text{C}$

Embedment depth ^{a)} and base material thickness for the basic loading data.
Mean ultimate resistance, characteristic resistance, design resistance, recommended loads.

Anchor size	M8	M10	M12	M16	M20	M24	M27	M30
Typical embedment depth [mm]	80	90	110	125	170	210	240	270
Base material thickness [mm]	140	160	210	210	340	370	480	540

a) The allowed range of embedment depth is shown in the setting details. The corresponding load values can be calculated according to the simplified design method.

Mean ultimate resistance: concrete C 20/25 – $f_{ck,cube} = 25 \text{ N/mm}^2$, anchor HAS

		Data according ETA-05/0255, issue 2011-06-23							
Anchor size		M8	M10	M12	M16	M20	M24	M27	M30
Carbon steel, strength class		5.8	5.8	5.8	5.8	5.8	5.8	8.8	8.8
Tensile $N_{Ru,m}$	HAS [kN]	17,9	27,3	39,9	75,6	117,6	168,0	249,3	297,4
Shear $V_{Ru,m}$	HAS [kN]	8,9	13,7	20,0	37,8	58,8	84,0	182,7	221,6

Characteristic resistance: concrete C 20/25 – $f_{ck,cube} = 25 \text{ N/mm}^2$, anchor HAS

		Data according ETA-05/0255, issue 2011-06-23							
Anchor size		M8	M10	M12	M16	M20	M24	M27	M30
Carbon steel, strength class		5.8	5.8	5.8	5.8	5.8	5.8	8.8	8.8
Tensile N_{Rk}	HAS [kN]	17,0	26,0	38,0	60,0	111,9	140,0	187,8	224,0
Shear V_{Rk}	HAS [kN]	8,5	13,0	19,0	36,0	56,0	80,0	174,0	211,0

Design resistance: concrete C 20/25 – $f_{ck,cube} = 25 \text{ N/mm}^2$, anchor HAS

		Data according ETA-05/0255, issue 2011-06-23							
Anchor size		M8	M10	M12	M16	M20	M24	M27	M30
Carbon steel, strength class		5.8	5.8	5.8	5.8	5.8	5.8	8.8	8.8
Tensile N_{Rd}	HAS [kN]	11,3	17,3	25,3	40,0	74,6	93,3	125,2	149,4
Shear V_{Rd}	HAS [kN]	6,8	10,4	15,2	28,8	44,8	64,0	139,2	168,8

Recommended loads ^{a)}: concrete C 20/25 – $f_{ck,cube} = 25 \text{ N/mm}^2$, anchor HAS

		Data according ETA-05/0255, issue 2011-06-23							
Anchor size		M8	M10	M12	M16	M20	M24	M27	M30
Carbon steel, strength class		5.8	5.8	5.8	5.8	5.8	5.8	8.8	8.8
Tensile N_{rec}	HAS [kN]	8,1	12,4	18,1	28,6	53,3	66,7	89,4	106,7
Shear V_{rec}	HAS [kN]	4,9	7,4	10,9	20,6	32,0	45,7	99,4	120,6

a) With overall partial safety factor for action $\gamma = 1,4$. The partial safety factors for action depend on the type of loading and shall be taken from national regulations.

Service temperature range

Hilti HVU adhesive may be applied in the temperature ranges given below. An elevated base material temperature may lead to a reduction of the design bond resistance.

Temperature range	Base material temperature	Maximum long term base material temperature	Maximum short term base material temperature
Temperature range I	-40 °C to +40 °C	+24 °C	+40 °C
Temperature range II	-40 °C to +80 °C	+50 °C	+80 °C
Temperature range III	-40 °C to +120 °C	+72 °C	+120 °C

Max short term base material temperature

Short-term elevated base material temperatures are those that occur over brief intervals, e.g. as a result of diurnal cycling.

Max long term base material temperature

Long-term elevated base material temperatures are roughly constant over significant periods of time.

Materials

Mechanical properties of HAS

			Data according ETA-05/0255, issue 2011-06-23							
Anchor size			M8	M10	M12	M16	M20	M24	M27	M30
Nominal tensile strength f_{uk}	HAS-(E)(F) 5.8	[N/mm ²]	500	500	500	500	500	500	-	-
	HAS-(E)(F) 8.8	[N/mm ²]	800	800	800	800	800	800	800	800
	HAS-(E)R	[N/mm ²]	700	700	700	700	700	700	500	500
	HAS-(E)HCR	[N/mm ²]	800	800	800	800	800	700	-	-
Yield strength f_{yk}	HAS-(E)(F) 5.8	[N/mm ²]	400	400	400	400	400	400	-	-
	HAS-(E)(F) 8.8	[N/mm ²]	640	640	640	640	640	640	640	640
	HAS-(E)R	[N/mm ²]	450	450	450	450	450	450	210	210
	HAS-(E)HCR	[N/mm ²]	640	640	640	640	640	400	-	-
Stressed cross-section A_s	HAS	[mm ²]	32,8	52,3	76,2	144	225	324	427	519
Moment of resistance W	HAS	[mm ³]	27,0	54,1	93,8	244	474	809	1274	1706

Material quality

Part	Material
Threaded rod HAS-(E)(F) M8-M24	Strength class 5.8, $A_5 > 8\%$ ductile steel galvanized $\geq 5 \mu\text{m}$ (F) hot dipped galvanized $\geq 45 \mu\text{m}$,
Threaded rod HAS-(E)F M8-M30	Strength class 8.8, $A_5 > 8\%$ ductile steel galvanized $\geq 5 \mu\text{m}$, (F) hot dipped galvanized $\geq 45 \mu\text{m}$,
Threaded rod HAS-(E)R	Stainless steel grade A4, $A_5 > 8\%$ ductile strength class 70 for $\leq M24$ and class 50 for M27 to M30, 1.4401; 1.4404; 1.4578; 1.4571; 1.4439; 1.4362
Threaded rod HAS-(E)HCR	High corrosion resistant steel, 1.4529; 1.4565 strength $\leq M20$: $R_m = 800 \text{ N/mm}^2$, $R_{p0.2} = 640 \text{ N/mm}^2$, $A_5 > 8\%$ ductile M24: $R_m = 700 \text{ N/mm}^2$, $R_{p0.2} = 400 \text{ N/mm}^2$, $A_5 > 8\%$ ductile
Washer ISO 7089	Steel galvanized, hot dipped galvanized,
	Stainless steel, 1.4401; 1.4404; 1.4578; 1.4571; 1.4439; 1.4362
	High corrosion resistant steel, 1.4529; 1.4565
Nut EN ISO 4032	Strength class 8, steel galvanized $\geq 5 \mu\text{m}$, hot dipped galvanized $\geq 45 \mu\text{m}$,
	Strength class 70, stainless steel grade A4, 1.4401; 1.4404; 1.4578; 1.4571; 1.4439; 1.4362
	Strength class 70, high corrosion resistant steel, 1.4529; 1.4565

Anchor dimensions

Anchor size	M8	M10	M12	M16	M20	M24	M27	M30
Anchor rod HAS-E, HAS-R, HAS-ER HAS-HCR	M8x80	M10x90	M12x110	M16x125	M20x170	M24x210	M27x240	M30x270
Anchor embedment depth [mm]	80	90	110	125	170	210	240	270

Setting

installation equipment

Anchor size	M8	M10	M12	M16	M20	M24	M27	M30
Rotary hammer	TE 1 – TE 30			TE 1 – TE 60	TE 50 – TE 60	TE 50 – TE 80		
Other tools	blow out pump or compressed air gun, setting tools							

Setting instruction

Dry and water-saturated concrete, hammer drilling

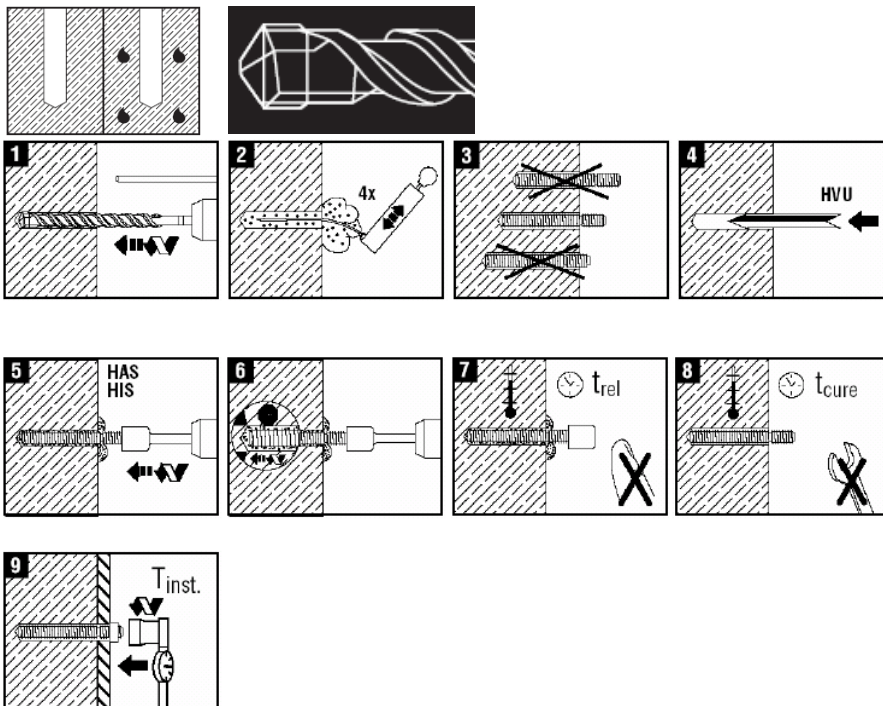

For detailed information on installation see instruction for use given with the package of the product.

For technical data for anchors in diamond drilled holes please contact the Hilti Technical advisory service.

Curing time for general conditions

Data according ETA-05/0255, issue 2011-06-23	
Temperature of the base material	Curing time before anchor can be fully loaded t_{cure}
20 °C to 40 °C	20 min
10 °C to 19 °C	30 min
0 °C to 9 °C	1 h
-5 °C to - 1 °C	5 h

Setting details

		Data according ETA-05/0255, issue 2011-06-23							
Anchor size		M8	M10	M12	M16	M20	M24	M27	M30
Nominal diameter of drill bit	d_0 [mm]	10	12	14	18	24	28	30	35
Effective anchorage and drill hole depth	h_{ef} [mm]	80	90	110	125	170	210	240	270
Minimum base material thickness	$h_{min}^a)$ [mm]	110	120	140	170	220	270	300	340
Diameter of clearance hole in the fixture	d_f [mm]	9	12	14	18	22	26	30	33
Minimum spacing	s_{min} [mm]	40	45	55	65	90	120	130	135
Minimum edge distance	c_{min} [mm]	40	45	55	65	90	120	130	135
Critical spacing for splitting failure	$s_{cr,sp}$	$2 c_{cr,sp}$							
Critical edge distance for splitting failure ^{b)}	$c_{cr,sp}$ [mm]	$1,0 \cdot h_{ef}$ for $h / h_{ef} \geq 2,0$							
		$4,6 h_{ef} - 1,8 h$ for $2,0 > h / h_{ef} > 1,3$							
		$2,26 h_{ef}$ for $h / h_{ef} \leq 1,3$							
Critical spacing for concrete cone failure	$s_{cr,N}$	$2 c_{cr,N}$							
Critical edge distance for concrete cone failure ^{c)}	$c_{cr,N}$	$1,5 h_{ef}$							
Critical spacing for concrete cone failure	$s_{cr,N}$	$2 c_{cr,N}$							
Critical edge distance for concrete cone failure	$c_{cr,N}$	$1,5 h_{ef}$							
Torque moment ^{c)}	T_{max} [Nm]	10	20	40	80	150	200	270	300

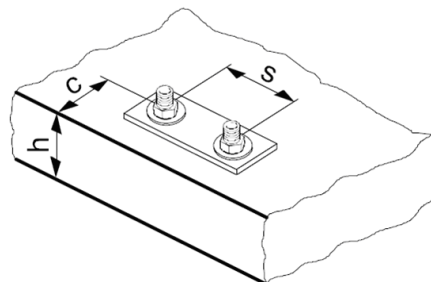

For spacing (edge distance) smaller than critical spacing (critical edge distance) the design loads have to be reduced.

- a) h : base material thickness ($h \geq h_{min}$)
- b) h : base material thickness ($h \geq h_{min}$)
- c) This is the maximum recommended torque moment to avoid splitting failure during installation for anchors with minimum spacing and/or edge distance.

Simplified design method

Simplified version of the design method according EOTA Technical Report TR 029. Design resistance according data given in ETA-05/0255, issue 2011-06-23.

- Influence of concrete strength
- Influence of edge distance
- Influence of spacing
- Valid for a group of two anchors. (The method may also be applied for anchor groups with more than two anchors or more than one edge distance. The influencing factors must then be considered for each edge distance and spacing. The calculated design loads are then on the same side: They will be lower than the exact values according EOTA Technical Report TR 029. To avoid this, it is recommended to use the anchor design software PROFIS anchor)

The design method is based on the following simplification:

- No different loads are acting on individual anchors (no eccentricity)

The values are valid for one anchor.

For more complex fastening applications please use the anchor design software PROFIS Anchor.

Tension loading

The design tensile resistance is the lower value of

- Steel resistance: $N_{Rd,s}$
- Combined pull-out and concrete cone resistance: $N_{Rd,p} = N_{Rd,p}^0 \cdot f_{B,p} \cdot f_{h,p}$
- Concrete cone resistance: $N_{Rd,c} = N_{Rd,c}^0 \cdot f_B \cdot f_{1,N} \cdot f_{2,N} \cdot f_{3,N} \cdot f_{h,N} \cdot f_{re,N}$
- Concrete splitting resistance (only non-cracked concrete): $N_{Rd,sp} = N_{Rd,c}^0 \cdot f_B \cdot f_{1,sp} \cdot f_{2,sp} \cdot f_{3,sp} \cdot f_{h,sp} \cdot f_{re,N}$

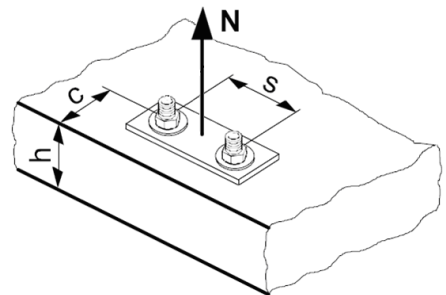

Basic design tensile resistance

Design steel resistance $N_{Rd,s}$

		Data according ETA-05/0255, issue 2011-06-23							
Anchor size		M8	M10	M12	M16	M20	M24	M27	M30
$N_{Rd,s}$	HAS-(E)(F) 5.8 [kN]	11,3	17,3	25,3	48,0	74,7	106,7	-	-
	HAS-(E)(F) 8.8 [kN]	18,0	28,0	40,7	76,7	119,3	170,7	231,3	281,3
	HAS-(E)-R [kN]	12,3	19,8	28,3	54,0	84,0	119,8	75,9	92,0
	HAS-(E)-HCR [kN]	18,0	28,0	40,7	76,7	119,3	106,7	-	-

Design combined pull-out and concrete cone resistance $N_{Rd,p} = N_{Rd,p}^0 \cdot f_{B,p} \cdot f_{h,p}$

		Data according ETA-05/0255, issue 2011-06-23							
Anchor size		M8	M10	M12	M16	M20	M24	M27	M30
Typical embedment depth $h_{ef,typ}$ [mm]		80	90	110	125	170	200	210	270
$N_{Rd,p}^0$	Temperature range I [kN]	16,7	23,3	33,3	40,0	76,7	93,3	133,3	166,7
$N_{Rd,p}^0$	Temperature range II [kN]	13,3	16,7	26,7	33,3	50,0	76,7	93,3	113,3
$N_{Rd,p}^0$	Temperature range III [kN]	6,0	8,0	10,7	16,7	26,7	40,0	50,0	50,0

Design concrete cone resistance $N_{Rd,c} = N_{Rd,c}^0 \cdot f_B \cdot f_{1,N} \cdot f_{2,N} \cdot f_{3,N} \cdot f_{h,N} \cdot f_{re,N}$

Design splitting resistance ^{a)} $N_{Rd,sp} = N_{Rd,c}^0 \cdot f_B \cdot f_{h,N} \cdot f_{1,sp} \cdot f_{2,sp} \cdot f_{3,sp} \cdot f_{re,N}$

		Data according ETA-05/0255, issue 2011-06-23							
Anchor size		M8	M10	M12	M16	M20	M24	M27	M30
$N_{Rd,c}^0$	[kN]	24,1	28,7	38,8	47,1	74,6	102,5	125,2	149,4

a) Splitting resistance must only be considered for non-cracked concrete

Influencing factors

Influence of concrete strength on combined pull-out and concrete cone resistance

Concrete strength designation (ENV 206)	C 20/25	C 25/30	C 30/37	C 35/45	C 40/50	C 45/55	C 50/60
$f_{B,p} = (f_{ck,cube}/25N/mm^2)^{0,14}$ ^{a)}	1	1,03	1,06	1,09	1,10	1,12	1,13

a) $f_{ck,cube}$ = concrete compressive strength, measured on cubes with 150 mm side length

Influence of embedment depth on combined pull-out and concrete cone resistance

$f_{h,p} = 1$

Influence of concrete strength on concrete cone resistance

Concrete strength designation (ENV 206)	C 20/25	C 25/30	C 30/37	C 35/45	C 40/50	C 45/55	C 50/60
$f_B = (f_{ck,cube}/25N/mm^2)^{1/2}$ ^{a)}	1	1,1	1,22	1,34	1,41	1,48	1,55

a) $f_{ck,cube}$ = concrete compressive strength, measured on cubes with 150 mm side length

Influence of edge distance ^{a)}

$c/c_{cr,N}$	0,1	0,2	0,3	0,4	0,5	0,6	0,7	0,8	0,9	1
$c/c_{cr,sp}$										
$f_{1,N} = 0,7 + 0,3 \cdot c/c_{cr,N}$	0,73	0,76	0,79	0,82	0,85	0,88	0,91	0,94	0,97	1
$f_{1,sp} = 0,7 + 0,3 \cdot c/c_{cr,sp}$										
$f_{2,N} = 0,5 \cdot (1 + c/c_{cr,N})$	0,55	0,60	0,65	0,70	0,75	0,80	0,85	0,90	0,95	1
$f_{2,sp} = 0,5 \cdot (1 + c/c_{cr,sp})$										

a) The edge distance shall not be smaller than the minimum edge distance c_{min} given in the table with the setting details. These influencing factors must be considered for every edge distance smaller than the critical edge distance.

Influence of anchor spacing ^{a)}

$s/s_{cr,N}$	0,1	0,2	0,3	0,4	0,5	0,6	0,7	0,8	0,9	1
$s/s_{cr,sp}$										
$f_{3,N} = 0,5 \cdot (1 + s/s_{cr,N})$	0,55	0,60	0,65	0,70	0,75	0,80	0,85	0,90	0,95	1
$f_{3,sp} = 0,5 \cdot (1 + s/s_{cr,sp})$										

a) The anchor spacing shall not be smaller than the minimum anchor spacing s_{min} given in the table with the setting details. This influencing factor must be considered for every anchor spacing.

Influence of embedment depth on concrete cone resistance

$f_{h,N} = 1$

Influence of reinforcement

h_{ef} [mm]	40	50	60	70	80	90	≥ 100
$f_{re,N} = 0,5 + h_{ef}/200\text{mm} \leq 1$	0,7 ^{a)}	0,75 ^{a)}	0,8 ^{a)}	0,85 ^{a)}	0,9 ^{a)}	0,95 ^{a)}	1

a) This factor applies only for dense reinforcement. If in the area of anchorage there is reinforcement with a spacing ≥ 150 mm (any diameter) or with a diameter ≤ 10 mm and a spacing ≥ 100 mm, then a factor $f_{re} = 1$ may be applied.

Shear loading

The design shear resistance is the lower value of

- Steel resistance: $V_{Rd,s}$
- Concrete pryout resistance: $V_{Rd,cp} = k \cdot \text{lower value of } N_{Rd,p} \text{ and } N_{Rd,c}$
- Concrete edge resistance: $V_{Rd,c} = V_{Rd,c}^0 \cdot f_B \cdot f_{f_4} \cdot f_h \cdot f_4$

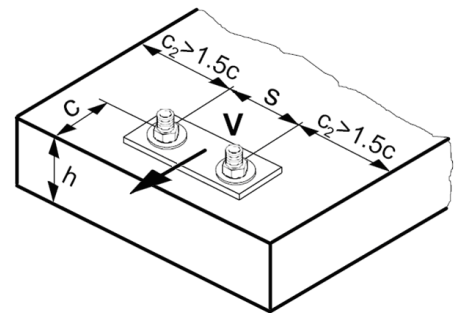

Basic design shear resistance

Design steel resistance $V_{Rd,s}$

		Data according ETA-05/0255, issue 2011-06-23							
Anchor size		M8	M10	M12	M16	M20	M24	M27	M30
$V_{Rd,s}$	HAS -(E) [kN]	6,6	10,6	15,2	28,8	44,9	64,1	138,8	168,6
	HAS -(E)F [kN]	10,6	16,9	24,4	46,1	71,8	102,6	138,8	168,6
	HAS -(E)-R [kN]	7,5	11,9	17,1	32,4	50,5	72,1	45,5	55,3
	HAS -(E)-HCR [kN]	10,6	16,9	24,4	46,1	71,8	64,1	-	-

Design concrete pryout resistance $V_{Rd,cp} = \text{lower value}^a)$ of $k \cdot N_{Rd,p}$ and $k \cdot N_{Rd,c}$

Anchor size	M8	M10	M12	M16	M20	M24	M27	M30
k	2							

a) $N_{Rd,p}$: Design combined pull-out and concrete cone resistance
 $N_{Rd,c}$: Design concrete cone resistance

Design concrete edge resistance $V_{Rd,c} = V_{Rd,c}^0 \cdot f_B \cdot f_{f_4} \cdot f_h \cdot f_4 \cdot f_{hef} \cdot f_c$

Anchor size	M8	M10	M12	M16	M20	M24	M27	M30
$V_{Rd,c}^0$ [kN]	5,9	8,5	11,6	18,8	27,3	37	45,1	53,8

a) For anchor groups only the anchors close to the edge must be considered.

Influencing factors

Influence of concrete strength

Concrete strength designation (ENV 206)	C 20/25	C 25/30	C 30/37	C 35/45	C 40/50	C 45/55	C 50/60
$f_B = (f_{ck,cube}/25\text{N/mm}^2)^{1/2}$ a)	1	1,1	1,22	1,34	1,41	1,48	1,55

a) $f_{ck,cube}$ = concrete compressive strength, measured on cubes with 150 mm side length

Influence of angle between load applied and the direction perpendicular to the free edge

Angle β	0°	10°	20°	30°	40°	50°	60°	70°	80°	≥ 90°
$f_{\beta} = \sqrt{\frac{1}{(\cos \alpha_v)^2 + \left(\frac{\sin \alpha_v}{2,5}\right)^2}}$	1	1,01	1,05	1,13	1,24	1,40	1,64	1,97	2,32	2,50

Influence of base material thickness

h/c	0,15	0,3	0,45	0,6	0,75	0,9	1,05	1,2	1,35	≥ 1,5
$f_h = \{h/(1,5 \cdot c)\}^{1/2} \leq 1$	0,32	0,45	0,55	0,63	0,71	0,77	0,84	0,89	0,95	1,00

Influence of anchor spacing and edge distance ^{a)} for concrete edge resistance: f_4 $f_4 = (c/h_{ef})^{1,5} \cdot (1 + s / [3 \cdot c]) \cdot 0,5$

c/h _{ef}	Single anchor	Group of two anchors s/h _{ef}														
		0,75	1,50	2,25	3,00	3,75	4,50	5,25	6,00	6,75	7,50	8,25	9,00	9,75	10,50	11,25
0,50	0,35	0,27	0,35	0,35	0,35	0,35	0,35	0,35	0,35	0,35	0,35	0,35	0,35	0,35	0,35	0,35
0,75	0,65	0,43	0,54	0,65	0,65	0,65	0,65	0,65	0,65	0,65	0,65	0,65	0,65	0,65	0,65	0,65
1,00	1,00	0,63	0,75	0,88	1,00	1,00	1,00	1,00	1,00	1,00	1,00	1,00	1,00	1,00	1,00	1,00
1,25	1,40	0,84	0,98	1,12	1,26	1,40	1,40	1,40	1,40	1,40	1,40	1,40	1,40	1,40	1,40	1,40
1,50	1,84	1,07	1,22	1,38	1,53	1,68	1,84	1,84	1,84	1,84	1,84	1,84	1,84	1,84	1,84	1,84
1,75	2,32	1,32	1,49	1,65	1,82	1,98	2,15	2,32	2,32	2,32	2,32	2,32	2,32	2,32	2,32	2,32
2,00	2,83	1,59	1,77	1,94	2,12	2,30	2,47	2,65	2,83	2,83	2,83	2,83	2,83	2,83	2,83	2,83
2,25	3,38	1,88	2,06	2,25	2,44	2,63	2,81	3,00	3,19	3,38	3,38	3,38	3,38	3,38	3,38	3,38
2,50	3,95	2,17	2,37	2,57	2,77	2,96	3,16	3,36	3,56	3,76	3,95	3,95	3,95	3,95	3,95	3,95
2,75	4,56	2,49	2,69	2,90	3,11	3,32	3,52	3,73	3,94	4,15	4,35	4,56	4,56	4,56	4,56	4,56
3,00	5,20	2,81	3,03	3,25	3,46	3,68	3,90	4,11	4,33	4,55	4,76	4,98	5,20	5,20	5,20	5,20
3,25	5,86	3,15	3,38	3,61	3,83	4,06	4,28	4,51	4,73	4,96	5,18	5,41	5,63	5,86	5,86	5,86
3,50	6,55	3,51	3,74	3,98	4,21	4,44	4,68	4,91	5,14	5,38	5,61	5,85	6,08	6,31	6,55	6,55
3,75	7,26	3,87	4,12	4,36	4,60	4,84	5,08	5,33	5,57	5,81	6,05	6,29	6,54	6,78	7,02	7,26
4,00	8,00	4,25	4,50	4,75	5,00	5,25	5,50	5,75	6,00	6,25	6,50	6,75	7,00	7,25	7,50	7,75
4,25	8,76	4,64	4,90	5,15	5,41	5,67	5,93	6,18	6,44	6,70	6,96	7,22	7,47	7,73	7,99	8,25
4,50	9,55	5,04	5,30	5,57	5,83	6,10	6,36	6,63	6,89	7,16	7,42	7,69	7,95	8,22	8,49	8,75
4,75	10,35	5,45	5,72	5,99	6,27	6,54	6,81	7,08	7,36	7,63	7,90	8,17	8,45	8,72	8,99	9,26
5,00	11,18	5,87	6,15	6,43	6,71	6,99	7,27	7,55	7,83	8,11	8,39	8,66	8,94	9,22	9,50	9,78
5,25	12,03	6,30	6,59	6,87	7,16	7,45	7,73	8,02	8,31	8,59	8,88	9,17	9,45	9,74	10,02	10,31
5,50	12,90	6,74	7,04	7,33	7,62	7,92	8,21	8,50	8,79	9,09	9,38	9,67	9,97	10,26	10,55	10,85

a) The anchor spacing and the edge distance shall not be smaller than the minimum anchor spacing s_{min} and the minimum edge distance c_{min} .

Influence of embedment depth

Anchor size	M8	M10	M12	M16	M20	M24	M27	M30
$f_{hef} = 0,05 \cdot (h_{ef} / d)^{1,68}$	2,39	2	2,07	1,58	1,82	1,91	1,96	2

Influence of edge distance ^{a)}

c/d	4	6	8	10	15	20	30	40
$f_c = (d / c)^{0,19}$	0,77	0,71	0,67	0,65	0,60	0,57	0,52	0,50

a) The edge distance shall not be smaller than the minimum edge distance c_{min} .

Combined tension and shear loading

For combined tension and shear loading see section "Anchor Design".

Precalculated values

Recommended loads can be calculated by dividing the design resistance by an overall partial safety factor for action $\gamma = 1,4$. The partial safety factors for action depend on the type of loading and shall be taken from national regulations.

Design resistance: concrete C 20/25 – $f_{ck,cube} = 25 \text{ N/mm}^2$

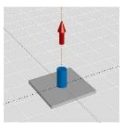
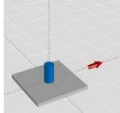
		Data according ETA-05/0255, issue 2011-06-23							
Anchor size		M8	M10	M12	M16	M20	M24	M27	M30
Carbon steel, strength class		5.8	5.8	5.8	5.8	5.8	5.8	8.8	8.8
Embedment depth	h_{ef} [mm]	80	90	110	125	170	210	240	270
Base material thickness	h_{min} [mm]	110	120	140	170	220	270	300	340
	Tensile N_{Rd}: single anchor, no edge effects								
	HAS-(E)(F) [kN]	11,3	17,3	25,3	40,0	74,6	93,3	125,2	149,4
	HAS-(E)-R [kN]	12,3	19,8	28,3	40,0	74,6	93,3	75,9	92,0
	HAS-(E)-HCR [kN]	16,7	23,3	33,3	40,0	74,6	93,3	-	-
	Shear V_{Rd}: single anchor, no edge effects, without lever arm								
	HAS-(E)(F) [kN]	6,8	10,4	15,2	28,8	44,8	64,0	139,2	168,8
	HAS-(E)-R [kN]	7,7	11,5	17,3	32,7	50,6	71,8	45,4	55,5
	HAS-(E)-HCR [kN]	9,6	14,4	21,6	40,8	63,2	64,0	-	-

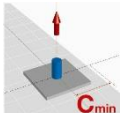
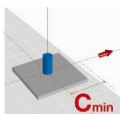

Design resistance: concrete C 20/25 – $f_{ck,cube} = 25 \text{ N/mm}^2$

		Data according ETA-05/0255, issue 2011-06-23							
Anchor size		M8	M10	M12	M16	M20	M24	M27	M30
Carbon steel, strength class		5.8	5.8	5.8	5.8	5.8	5.8	8.8	8.8
Embedment depth	h_{ef} [mm]	80	90	110	125	170	210	240	270
Base material thickness	h_{min} [mm]	110	120	140	170	220	270	300	340
Edge distance	$c = c_{min}$ [mm]	40	45	55	65	90	120	130	135
	Tensile N_{Rd}: single anchor, min. edge distance ($c = c_{min}$)								
	HAS-(E)(F) [kN]	9,4	12,7	18,2	22,0	35,5	49,8	59,9	69,9
	HAS-(E)-R [kN]	9,4	12,7	18,2	22,0	35,5	49,8	59,9	69,9
	HAS-(E)-HCR [kN]	9,4	12,7	18,2	22,0	35,5	49,8	-	-
	Shear V_{Rd}: single anchor, min. edge distance ($c = c_{min}$), without lever arm								
	HAS-(E)(F) [kN]	3,7	4,7	6,6	8,9	15,1	23,6	27,7	30,7
	HAS-(E)-R [kN]	3,7	4,7	6,6	8,9	15,1	23,6	27,7	30,7
	HAS-(E)-HCR [kN]	3,7	4,7	6,6	8,9	15,1	23,6	-	-

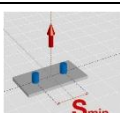
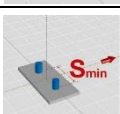
Design resistance: concrete C 20/25 – $f_{ck,cube} = 25 \text{ N/mm}^2$ (load values are valid for single anchor)

		Data according ETA-05/0255, issue 2011-06-23							
Anchor size		M8	M10	M12	M16	M20	M24	M27	M30
Carbon steel, strength class		5.8	5.8	5.8	5.8	5.8	5.8	8.8	8.8
Embedment depth	h_{ef} [mm]	80	90	110	125	170	210	240	270
Base material thickness	h_{min} [mm]	110	120	140	170	220	270	300	340
Spacing	$s = s_{min}$ [mm]	40	45	55	65	90	120	130	135
	Tensile N_{Rd}: double anchor, no edge effects, min. spacing ($s = s_{min}$)								
	HAS-(E)(F) [kN]	10,9	14,6	20,6	24,8	41,7	57,7	70,1	82,9
	HAS-(E)-R [kN]	10,9	14,6	20,6	24,8	41,7	57,7	70,1	82,9
	HAS-(E)-HCR [kN]	10,9	14,6	20,6	24,8	41,7	57,7	-	-
	Shear V_{Rd}: double anchor, no edge effects, min. spacing ($s = s_{min}$), without lever arm								
	HAS-(E)(F) [kN]	6,8	10,4	15,2	28,8	44,8	64,0	139,2	168,8
	HAS-(E)-R [kN]	7,7	11,5	17,3	32,7	50,6	71,8	45,4	55,5
	HAS-(E)-HCR [kN]	9,6	14,4	21,6	40,8	63,2	64,0	-	-

HVU with HIS-(R)N sleeve adhesive anchor system

Mortar system	Benefits
 <p>Hilti HVU foil capsule</p>	<ul style="list-style-type: none"> - suitable for non-cracked concrete C 20/25 to C 50/60 - high loading capacity - suitable for dry and water saturated concrete
 <p>HIS-(R)N sleeve</p>	



Concrete

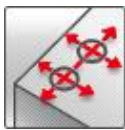

Small edge distance and spacing



Fire resistance

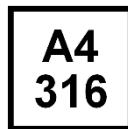

Corrosion resistance



European Technical Approval



CE conformity



PROFIS Anchor design software

Approvals / certificates

Description	Authority / Laboratory	No. / date of issue
European technical approval ^{a)}	DIBt, Berlin	ETA-05/0255 / 2011-06-23
Fire test report	IBMB, Braunschweig	UB-3333/0891-1 / 2004-03-26
Assessment report (fire)	warringtonfire	WF 327804/B / 2013-07-10

a) All data given in this section according to ETA-05/0255, issue 2011-06-23.

Basic loading data (for a single anchor)

All data in this section applies to

- Correct setting (See setting instruction)
- No edge distance and spacing influence
- Steel failure
- Screw strength class 8.8
- Base material thickness, as specified in the table
- One typical embedment depth, as specified in the table
- One anchor material, as specified in the tables
- Concrete C 20/25, $f_{ck,cube} = 25 \text{ N/mm}^2$
- Temperate range I
(min. base material temperature -40°C, max. long term/short term base material temperature: +24°C/40°C)
- Installation temperature range -5°C to +40°C

For details see Simplified design method

Embedment depth and base material thickness for the basic loading data.
Mean ultimate resistance, characteristic resistance, design resistance, recommended loads.

Anchor size	M8	M10	M12	M16	M20
Embedment depth [mm]	90	110	125	170	205
Base material thickness [mm]	120	150	180	250	350

Mean ultimate resistance: concrete C 20/25 – $f_{ck,cube} = 25 \text{ N/mm}^2$, anchor HIS-N

Data according ETA-05/0255, issue 2011-06-23							
Anchor size			M8	M10	M12	M16	M20
Tensile $N_{Ru,m}$	HIS-N	[kN]	26,3	48,3	70,4	123,9	114,5
Shear $V_{Ru,m}$	HIS-N	[kN]	13,7	24,2	41,0	62,0	57,8

Characteristic resistance: concrete C 20/25 – $f_{ck,cube} = 25 \text{ N/mm}^2$, anchor HIS-N

Data according ETA-05/0255, issue 2011-06-23							
Anchor size			M8	M10	M12	M16	M20
Tensile N_{Rk}	HIS-N	[kN]	25,0	40,0	60,0	95,0	109,0
Shear V_{Rk}	HIS-N	[kN]	13,0	23,0	39,0	59,0	55,0

Design resistance: concrete C 20/25 – $f_{ck,cube} = 25 \text{ N/mm}^2$, anchor HIS-N

Data according ETA-05/0255, issue 2011-06-23							
Anchor size			M8	M10	M12	M16	M20
Tensile N_{Rd}	HIS-N	[kN]	16,7	26,7	40,0	63,3	74,1
Shear V_{Rd}	HIS-N	[kN]	10,4	18,4	26,0	39,3	36,7

Recommended loads ^{a)}: concrete C 20/25 – $f_{ck,cube} = 25 \text{ N/mm}^2$, anchor HIS-N

Data according ETA-05/0255, issue 2011-06-23							
Anchor size			M8	M10	M12	M16	M20
Tensile N_{rec}	HIS-N	[kN]	11,9	19,0	28,6	45,2	53,0
Shear V_{rec}	HIS-N	[kN]	7,4	13,1	18,6	28,1	26,2

a) With overall partial safety factor for action $\gamma = 1,4$. The partial safety factors for action depend on the type of loading and shall be taken from national regulations.

Service temperature range

Hilti HVU adhesive may be applied in the temperature ranges given below. An elevated base material temperature may lead to a reduction of the design bond resistance.

Temperature range	Base material temperature	Maximum long term base material temperature	Maximum short term base material temperature
Temperature range I	-40 °C to +40 °C	+24 °C	+40 °C
Temperature range II	-40 °C to +80 °C	+50 °C	+80 °C
Temperature range III	-40 °C to +120 °C	+72 °C	+120 °C

Max short term base material temperature

Short-term elevated base material temperatures are those that occur over brief intervals, e.g. as a result of diurnal cycling.

Max long term base material temperature

Long-term elevated base material temperatures are roughly constant over significant periods of time.

Materials

Mechanical properties of HIS-(R)N

			Data according ETA-05/0255, issue 2011-06-23				
Anchor size			M8	M10	M12	M16	M20
Nominal tensile strength f_{uk}	HIS-N	[N/mm ²]	490	490	460	460	460
	Screw 8.8	[N/mm ²]	800	800	800	800	800
	HIS-RN	[N/mm ²]	700	700	700	700	700
	Screw A4-70	[N/mm ²]	700	700	700	700	700
Yield strength f_{yk}	HIS-N	[N/mm ²]	410	410	375	375	375
	Screw 8.8	[N/mm ²]	640	640	640	640	640
	HIS-RN	[N/mm ²]	350	350	350	350	350
	Screw A4-70	[N/mm ²]	450	450	450	450	450
Stressed cross-section A_s	HIS-(R)N	[mm ²]	51,5	108,0	169,1	256,1	237,6
	Screw	[mm ²]	36,6	58	84,3	157	245
Moment of resistance W	HIS-(R)N	[mm ³]	145	430	840	1595	1543
	Screw	[mm ³]	31,2	62,3	109	277	541

Material quality

Part	Material
internally threaded sleeves ^{a)} HIS-N	C-steel 1.0718, steel galvanized $\geq 5\mu\text{m}$
internally threaded sleeves ^{b)} HIS-RN	stainless steel 1.4401 and 1.4571

a) related fastening screw: strength class 8.8, A5 > 8% Ductile steel galvanized $\geq 5\mu\text{m}$

b) related fastening screw: strength class 70, A5 > 8% Ductile stainless steel 1.4401; 1.4404; 1.4578; 1.4571; 1.4439; 1.4362

Anchor dimensions

Anchor size	M8	M10	M12	M16	M20
Internal sleeve HIS-(R)N	M8x90	M10x110	M12x125	M16x170	M20x205
Anchor embedment depth [mm]	90	110	125	170	205

Setting

installation equipment

Anchor size	M8	M10	M12	M16	M20
Rotary hammer	TE1 – TE30	TE1 – TE60	TE1 – TE80	TE50 – TE80	TE60 – TE80
Other tools	blow out pump or compressed air gun, setting tools				

Setting instruction

Dry and water-saturated concrete, hammer drilling

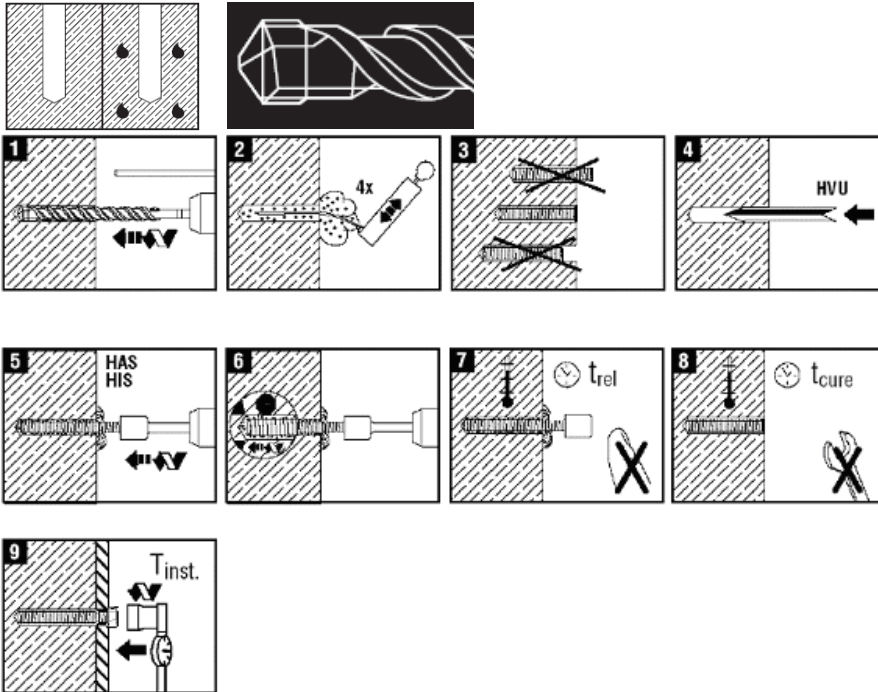

For detailed information on installation see instruction for use given with the package of the product.

For technical data for anchors in diamond drilled holes please contact the Hilti Technical advisory service.

Curing time for general conditions

Data according ETA-05/0255, issue 2011-06-23	
Temperature of the base material	Curing time before anchor can be fully loaded t_{cure}
20 °C to 40 °C	20 min
10 °C to 19 °C	30 min
0 °C to 9 °C	1 h
-5 °C to -1 °C	5 h

Setting details

		Data according ETA-05/0255, issue 2011-06-23				
Anchor size	Sleeve HIS-(R)N foil capsule	M8x90 M10x90	M10x110 M12x110	M12x125 M16x125	M16x170 M20x170	M20x205 M24x210
Nominal diameter of drill bit	d_0 [mm]	14	18	22	28	32
Diameter of element	d [mm]	12,5	16,5	20,5	25,4	27,6
Effective anchorage and drill hole depth	h_{ef} [mm]	90	110	125	170	205
Minimum base material thickness	h_{min} [mm]	120	150	170	230	270
Diameter of clearance hole in the fixture	d_f [mm]	9	12	14	18	22
Thread engagement length; min - max	h_s [mm]	8-20	10-25	12-30	16-40	20-50
Minimum spacing	s_{min} [mm]	40	45	60	80	125
Minimum edge distance	c_{min} [mm]	40	45	60	80	125
Critical spacing for splitting failure	$s_{cr,sp}$	$2 c_{cr,sp}$				
Critical edge distance for splitting failure ^{a)}	$c_{cr,sp}$ [mm]	$1,0 \cdot h_{ef}$ for $h / h_{ef} \geq 2,0$				
		$4,6 h_{ef} - 1,8 h$ for $2,0 > h / h_{ef} > 1,3$				
		$2,26 h_{ef}$ for $h / h_{ef} \leq 1,3$				
Critical spacing for concrete cone failure	$s_{cr,N}$	$2 c_{cr,N}$				
Critical edge distance for concrete cone failure	$c_{cr,N}$	$1,5 h_{ef}$				
Torque moment ^{b)}	T_{max} [Nm]	10	20	40	80	150

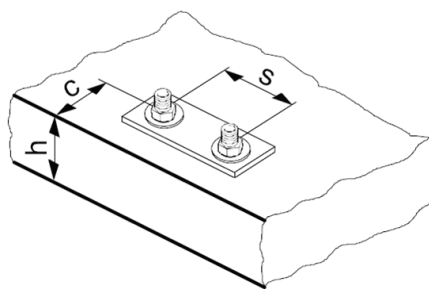

For spacing (edge distance) smaller than critical spacing (critical edge distance) the design loads have to be reduced.

- a) h : base material thickness ($h \geq h_{min}$)
- b) This is the maximum recommended torque moment to avoid splitting failure during installation for anchors with minimum spacing and/or edge distance.

Simplified design method

Simplified version of the design method according EOTA Technical Report TR 029. Design resistance according data given in ETA-05/0255, issue 2011-06-23.

- Influence of concrete strength
- Influence of edge distance
- Influence of spacing
- Valid for a group of two anchors. (The method may also be applied for anchor groups with more than two anchors or more than one edge distance. The influencing factors must then be considered for each edge distance and spacing. The calculated design loads are then on the same side: They will be lower than the exact values according EOTA Technical Report TR 029. To avoid this, it is recommended to use the anchor design software PROFIS anchor)

The design method is based on the following simplification:

- No different loads are acting on individual anchors (no eccentricity)

The values are valid for one anchor.

For more complex fastening applications please use the anchor design software PROFIS Anchor.

Tension loading

The design tensile resistance is the lower value of

- Steel resistance: $N_{Rd,s}$
- Combined pull-out and concrete cone resistance: $N_{Rd,p} = N_{Rd,p}^0 \cdot f_{B,p} \cdot f_{h,p}$
- Concrete cone resistance: $N_{Rd,c} = N_{Rd,c}^0 \cdot f_B \cdot f_{1,N} \cdot f_{2,N} \cdot f_{3,N} \cdot f_{h,N} \cdot f_{re,N}$
- Concrete splitting resistance (only non-cracked concrete): $N_{Rd,sp} = N_{Rd,c}^0 \cdot f_B \cdot f_{1,sp} \cdot f_{2,sp} \cdot f_{3,sp} \cdot f_{h,sp} \cdot f_{re,N}$

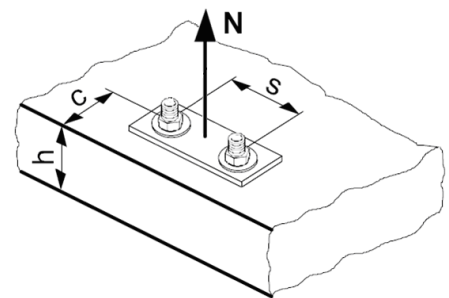

Basic design tensile resistance

Design steel resistance $N_{Rd,s}$

		Data according ETA-05/0255, issue 2011-06-23				
Anchor size		M8	M10	M12	M16	M20
$N_{Rd,s}$	HIS-N [kN]	17,5	30,7	44,7	80,3	74,1
	HIS-RN [kN]	13,9	21,9	31,6	58,8	69,2

Design combined pull-out and concrete cone resistance $N_{Rd,p} = N_{Rd,p}^0 \cdot f_{B,p} \cdot f_{h,p}$

		Data according ETA-05/0255, issue 2011-06-23				
Anchor size		M8	M10	M12	M16	M20
Embedment depth h_{ef} [mm]		90	110	125	170	205
$N_{Rd,p}^0$	Temperature range I [kN]	16,7	26,7	40,0	63,3	93,3
$N_{Rd,p}^0$	Temperature range II [kN]	13,3	23,3	33,3	50,0	63,3
$N_{Rd,p}^0$	Temperature range III [kN]	6,0	10,7	13,3	26,7	33,3

Design concrete cone resistance $N_{Rd,c} = N_{Rd,c}^0 \cdot f_B \cdot f_{1,N} \cdot f_{2,N} \cdot f_{3,N} \cdot f_{h,N} \cdot f_{re,N}$

Design splitting resistance ^{a)} $N_{Rd,sp} = N_{Rd,c}^0 \cdot f_B \cdot f_{h,N} \cdot f_{1,sp} \cdot f_{2,sp} \cdot f_{3,sp} \cdot f_{re,N}$

		Data according ETA-05/0255, issue 2011-06-23				
Anchor size		M8	M10	M12	M16	M20
$N_{Rd,c}^0$	[kN]	28,7	38,8	47,1	74,6	98,8

a) Splitting resistance must only be considered for non-cracked concrete

Influencing factors

Influence of concrete strength on combined pull-out and concrete cone resistance

Concrete strength designation (ENV 206)	C 20/25	C 25/30	C 30/37	C 35/45	C 40/50	C 45/55	C 50/60
$f_{B,p} = (f_{ck,cube}/25N/mm^2)^{0,28}$ a)	1	1,05	1,12	1,18	1,21	1,25	1,28

a) $f_{ck,cube}$ = concrete compressive strength, measured on cubes with 150 mm side length

Influence of embedment depth on combined pull-out and concrete cone resistance

$f_{h,p} = 1$

Influence of concrete strength on concrete cone resistance

Concrete strength designation (ENV 206)	C 20/25	C 25/30	C 30/37	C 35/45	C 40/50	C 45/55	C 50/60
$f_B = (f_{ck,cube}/25N/mm^2)^{1/2}$ a)	1	1,1	1,22	1,34	1,41	1,48	1,55

a) $f_{ck,cube}$ = concrete compressive strength, measured on cubes with 150 mm side length

Influence of edge distance a)

$c/c_{cr,N}$	0,1	0,2	0,3	0,4	0,5	0,6	0,7	0,8	0,9	1
$c/c_{cr,sp}$										
$f_{1,N} = 0,7 + 0,3 \cdot c/c_{cr,N}$	0,73	0,76	0,79	0,82	0,85	0,88	0,91	0,94	0,97	1
$f_{1,sp} = 0,7 + 0,3 \cdot c/c_{cr,sp}$										
$f_{2,N} = 0,5 \cdot (1 + c/c_{cr,N})$	0,55	0,60	0,65	0,70	0,75	0,80	0,85	0,90	0,95	1
$f_{2,sp} = 0,5 \cdot (1 + c/c_{cr,sp})$										

a) The edge distance shall not be smaller than the minimum edge distance c_{min} given in the table with the setting details. These influencing factors must be considered for every edge distance smaller than the critical edge distance.

Influence of anchor spacing a)

$s/s_{cr,N}$	0,1	0,2	0,3	0,4	0,5	0,6	0,7	0,8	0,9	1
$s/s_{cr,sp}$										
$f_{3,N} = 0,5 \cdot (1 + s/s_{cr,N})$	0,55	0,60	0,65	0,70	0,75	0,80	0,85	0,90	0,95	1
$f_{3,sp} = 0,5 \cdot (1 + s/s_{cr,sp})$										

a) The anchor spacing shall not be smaller than the minimum anchor spacing s_{min} given in the table with the setting details. This influencing factor must be considered for every anchor spacing.

Influence of embedment depth on concrete cone resistance

$f_{h,N} = 1$

Influence of reinforcement

h_{ef} [mm]	80	90	≥ 100
$f_{re,N} = 0,5 + h_{ef}/200mm \leq 1$	0,9 ^{a)}	0,95 ^{a)}	1

a) This factor applies only for dense reinforcement. If in the area of anchorage there is reinforcement with a spacing ≥ 150 mm (any diameter) or with a diameter ≤ 10 mm and a spacing ≥ 100 mm, then a factor $f_{re} = 1$ may be applied.

Shear loading

The design shear resistance is the lower value of

- Steel resistance: $V_{Rd,s}$
- Concrete pryout resistance: $V_{Rd,cp} = k \cdot \text{lower value of } N_{Rd,p} \text{ and } N_{Rd,c}$
- Concrete edge resistance: $V_{Rd,c} = V_{Rd,c}^0 \cdot f_B \cdot f_\beta \cdot f_h \cdot f_4$

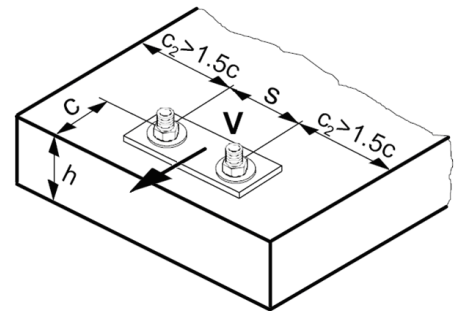

Basic design shear resistance

Design steel resistance $V_{Rd,s}$

		Data according ETA-05/0255, issue 2011-06-23				
Anchor size		M8	M10	M12	M16	M20
$V_{Rd,s}$	HIS-N [kN]	10,4	18,4	26,0	39,3	36,7
	HIS-RN [kN]	8,3	12,8	19,2	35,3	41,5

Design concrete pryout resistance $V_{Rd,cp} = k \cdot N_{Rd,c}^a)$

Anchor size	M8	M10	M12	M16	M20
k	2				

a) $N_{Rd,c}$: Design concrete cone resistance

Design concrete edge resistance $V_{Rd,c} = V_{Rd,c}^0 \cdot f_B \cdot f_\beta \cdot f_h \cdot f_4 \cdot f_{hef} \cdot f_c$

Anchor size	M8	M10	M12	M16	M20
$V_{Rd,c}^0$ [kN]	12,4	19,8	28,4	40,7	46,8

a) For anchor groups only the anchors close to the edge must be considered.

Influencing factors

Influence of concrete strength

Concrete strength designation (ENV 206)	C 20/25	C 25/30	C 30/37	C 35/45	C 40/50	C 45/55	C 50/60
$f_B = (f_{ck,cube}/25N/mm^2)^{1/2}$ a)	1	1,1	1,22	1,34	1,41	1,48	1,55

a) $f_{ck,cube}$ = concrete compressive strength, measured on cubes with 150 mm side length

Influence of angle between load applied and the direction perpendicular to the free edge

Angle β	0°	10°	20°	30°	40°	50°	60°	70°	80°	≥ 90°
$f_\beta = \sqrt{\frac{1}{(\cos \alpha_v)^2 + \left(\frac{\sin \alpha_v}{2,5}\right)^2}}$	1	1,01	1,05	1,13	1,24	1,40	1,64	1,97	2,32	2,50

Influence of base material thickness

h/c	0,15	0,3	0,45	0,6	0,75	0,9	1,05	1,2	1,35	≥ 1,5
$f_h = \{h/(1,5 \cdot c)\}^{1/2} \leq 1$	0,32	0,45	0,55	0,63	0,71	0,77	0,84	0,89	0,95	1,00

Influence of anchor spacing and edge distance ^{a)} for concrete edge resistance: f_4

$$f_4 = (c/h_{ef})^{1,5} \cdot (1 + s / [3 \cdot c]) \cdot 0,5$$

c/h _{ef}	Single anchor	Group of two anchors s/h _{ef}														
		0,75	1,50	2,25	3,00	3,75	4,50	5,25	6,00	6,75	7,50	8,25	9,00	9,75	10,50	11,25
0,50	0,35	0,27	0,35	0,35	0,35	0,35	0,35	0,35	0,35	0,35	0,35	0,35	0,35	0,35	0,35	0,35
0,75	0,65	0,43	0,54	0,65	0,65	0,65	0,65	0,65	0,65	0,65	0,65	0,65	0,65	0,65	0,65	0,65
1,00	1,00	0,63	0,75	0,88	1,00	1,00	1,00	1,00	1,00	1,00	1,00	1,00	1,00	1,00	1,00	1,00
1,25	1,40	0,84	0,98	1,12	1,26	1,40	1,40	1,40	1,40	1,40	1,40	1,40	1,40	1,40	1,40	1,40
1,50	1,84	1,07	1,22	1,38	1,53	1,68	1,84	1,84	1,84	1,84	1,84	1,84	1,84	1,84	1,84	1,84
1,75	2,32	1,32	1,49	1,65	1,82	1,98	2,15	2,32	2,32	2,32	2,32	2,32	2,32	2,32	2,32	2,32
2,00	2,83	1,59	1,77	1,94	2,12	2,30	2,47	2,65	2,83	2,83	2,83	2,83	2,83	2,83	2,83	2,83
2,25	3,38	1,88	2,06	2,25	2,44	2,63	2,81	3,00	3,19	3,38	3,38	3,38	3,38	3,38	3,38	3,38
2,50	3,95	2,17	2,37	2,57	2,77	2,96	3,16	3,36	3,56	3,76	3,95	3,95	3,95	3,95	3,95	3,95
2,75	4,56	2,49	2,69	2,90	3,11	3,32	3,52	3,73	3,94	4,15	4,35	4,56	4,56	4,56	4,56	4,56
3,00	5,20	2,81	3,03	3,25	3,46	3,68	3,90	4,11	4,33	4,55	4,76	4,98	5,20	5,20	5,20	5,20
3,25	5,86	3,15	3,38	3,61	3,83	4,06	4,28	4,51	4,73	4,96	5,18	5,41	5,63	5,86	5,86	5,86
3,50	6,55	3,51	3,74	3,98	4,21	4,44	4,68	4,91	5,14	5,38	5,61	5,85	6,08	6,31	6,55	6,55
3,75	7,26	3,87	4,12	4,36	4,60	4,84	5,08	5,33	5,57	5,81	6,05	6,29	6,54	6,78	7,02	7,26
4,00	8,00	4,25	4,50	4,75	5,00	5,25	5,50	5,75	6,00	6,25	6,50	6,75	7,00	7,25	7,50	7,75
4,25	8,76	4,64	4,90	5,15	5,41	5,67	5,93	6,18	6,44	6,70	6,96	7,22	7,47	7,73	7,99	8,25
4,50	9,55	5,04	5,30	5,57	5,83	6,10	6,36	6,63	6,89	7,16	7,42	7,69	7,95	8,22	8,49	8,75
4,75	10,35	5,45	5,72	5,99	6,27	6,54	6,81	7,08	7,36	7,63	7,90	8,17	8,45	8,72	8,99	9,26
5,00	11,18	5,87	6,15	6,43	6,71	6,99	7,27	7,55	7,83	8,11	8,39	8,66	8,94	9,22	9,50	9,78
5,25	12,03	6,30	6,59	6,87	7,16	7,45	7,73	8,02	8,31	8,59	8,88	9,17	9,45	9,74	10,02	10,31
5,50	12,90	6,74	7,04	7,33	7,62	7,92	8,21	8,50	8,79	9,09	9,38	9,67	9,97	10,26	10,55	10,85

a) The anchor spacing and the edge distance shall not be smaller than the minimum anchor spacing s_{min} and the minimum edge distance c_{min} .

Influence of embedment depth

Anchor size	M8	M10	M12	M16	M20
$f_{hef} = 0,05 \cdot (h_{ef} / d)^{1,68}$	1,38	1,21	1,04	1,22	1,45

Influence of edge distance ^{a)}

c/d	4	6	8	10	15	20	30	40
$f_c = (d / c)^{0,19}$	0,77	0,71	0,67	0,65	0,60	0,57	0,52	0,50

a) The edge distance shall not be smaller than the minimum edge distance c_{min} .

Combined tension and shear loading

For combined tension and shear loading see section "Anchor Design".

Precalculated values

Recommended loads can be calculated by dividing the design resistance by an overall partial safety factor for action $\gamma = 1,4$. The partial safety factors for action depend on the type of loading and shall be taken from national regulations.

Design resistance: concrete C 20/25 – $f_{ck,cube} = 25 \text{ N/mm}^2$

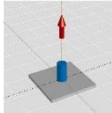
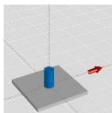
Data according ETA-05/0255, issue 2011-06-23						
Anchor size		M8	M10	M12	M16	M20
Embedment depth h_{ef} [mm]		90	110	125	170	205
Base material thickness h_{min} [mm]		120	150	170	230	270
	Tensile N_{Rd}: single anchor, no edge effects					
HIS-N [kN]		16,7	26,7	40,0	63,3	74,1
HIS-RN [kN]		13,9	21,9	31,6	58,8	69,2
	Shear V_{Rd}: single anchor, no edge effects, without lever arm					
HIS-N [kN]		10,4	18,4	26,0	39,3	36,7
HIS-RN [kN]		8,3	12,8	19,2	35,3	41,5

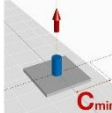
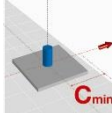

Design resistance: concrete C 20/25 – $f_{ck,cube} = 25 \text{ N/mm}^2$

Data according ETA-05/0255, issue 2011-06-23						
Anchor size		M8	M10	M12	M16	M20
Embedment depth h_{ef} [mm]		90	110	125	170	205
Base material thickness h_{min} [mm]		120	150	170	230	270
Edge distance $c = c_{min}$ [mm]		40	45	60	80	125
	Tensile N_{Rd}: single anchor, min. edge distance ($c = c_{min}$)					
HIS-(R)N [kN]		8,9	13,4	21,0	33,5	49,2
	Shear V_{Rd}: single anchor, min. edge distance ($c = c_{min}$), without lever arm					
HIS-(R)N [kN]		4,2	5,5	8,5	13,8	25,3

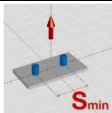
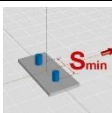
Design resistance: concrete C 20/25 – $f_{ck,cube} = 25 \text{ N/mm}^2$
(load values are valid for single anchor)

Data according ETA-05/0255, issue 2011-06-23						
Anchor size		M8	M10	M12	M16	M20
Embedment depth h_{ef} [mm]		90	110	125	170	205
Base material thickness h_{min} [mm]		120	150	170	230	270
Spacing $s = s_{min}$ [mm]		40	45	60	80	125
	Tensile N_{Rd}: double anchor, no edge effects, min. spacing ($s = s_{min}$)					
HIS-(R)N [kN]		11,0	16,9	24,4	38,8	56,2
	Shear V_{Rd}: double anchor, no edge effects, min. spacing ($s = s_{min}$), without lever arm					
HIS-N [kN]		10,4	18,4	26,0	39,3	36,7
HIS-RN [kN]		8,3	12,8	19,2	35,3	41,5

Hilti HIT-RE 500-SD mortar with HIT-V rod

Injection mortar system	Benefits
 <p>Hilti HIT-RE 500-SD 330 ml foil pack (also available as 500 ml and 1400 ml foil pack)</p>  <p>Static mixer</p>  <p>HIT-V rod</p>	<ul style="list-style-type: none"> - SAFEset technology: drilling and borehole cleaning in one step with Hilti hollow drill bit - suitable for non-cracked and cracked concrete C 20/25 to C 50/60 - ETA seismic approval C1 - high loading capacity - suitable for dry and water saturated concrete - large diameter applications - high corrosion resistant - long working time at elevated temperatures - odourless epoxy - embedment depth range: from 40 ... 160 mm for M8 to 120 ... 600 mm for M30



Concrete



Tensile zone



Seismic
ETA-C1



Shock



Small edge
distance
and spacing

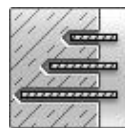

Variable
embedment
depth



Fire
resistance

SAFEset

Hilti SAFEset
technology with
hollow drill bit

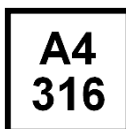

Corrosion
resistance



High
corrosion
resistance



European
Technical
Approval



CE
conformity



PROFIS
Anchor design
software

Approvals / certificates

Description	Authority / Laboratory	No. / date of issue
European technical approval ^{a)}	DIBt, Berlin	ETA-07/0260 / 2013-06-26
ES report incl. seismic	ICC evaluation service	ESR 2322 / 2014-02-01
Shockproof fastenings in civil defence installations	Federal Office for Civil Protection, Bern	BZS D 08-604 / 2009-10-21
Fire test report	MFPA, Leipzig	GS-III/B-07-070 / 2008-01-18
Assessment report (fire)	warringtonfire	WF 327804/B / 2013-07-10

a) All data given in this section according ETA-07/0260, issue 2013-06-26.

Basic loading data (for a single anchor)

All data in this section applies to

For details see Simplified design method

- Correct setting (See setting instruction)
- No edge distance and spacing influence
- Steel failure
- Base material thickness, as specified in the table
- One typical embedment depth, as specified in the table
- One anchor material, as specified in the tables
- Concrete C 20/25, $f_{ck,cube} = 25 \text{ N/mm}^2$
- Temperature range I
(min. base material temperature -40°C , max. long term/short term base material temperature: $+24^\circ\text{C}/40^\circ\text{C}$)
- Installation temperature range $+5^\circ\text{C}$ to $+40^\circ\text{C}$

Embedment depth ^{a)} and base material thickness for the basic loading data.

Mean ultimate resistance, characteristic resistance, design resistance, recommended loads.

Anchor size	M8	M10	M12	M16	M20	M24	M27	M30
Typical embedment depth [mm]	80	90	110	125	170	210	240	270
Base material thickness [mm]	110	120	140	165	220	270	300	340

a) The allowed range of embedment depth is shown in the setting details. The corresponding load values can be calculated according to the simplified design method.

Mean ultimate resistance: concrete C 20/25 – $f_{ck,cube} = 25 \text{ N/mm}^2$, anchor HIT-V 5.8

Data according ETA-07/0260, issue 2013-06-26									
Anchor size	M8	M10	M12	M16	M20	M24	M27	M30	
Non cracked concrete									
Tensile $N_{Ru,m}$ HIT-V 5.8 [kN]	18,9	30,5	44,1	83,0	129,2	185,9	241,5	295,1	
Shear $V_{Ru,m}$ HIT-V 5.8 [kN]	9,5	15,8	22,1	41,0	64,1	92,4	120,8	147,0	
Cracked concrete									
Tensile $N_{Ru,m}$ HIT-V 5.8 [kN]	18,9	30,5	44,1	65,2	110,8	146,1	196,0	226,2	
Shear $V_{Ru,m}$ HIT-V 5.8 [kN]	9,5	15,8	22,1	41,0	64,1	92,4	120,8	147,0	

Characteristic resistance: concrete C 20/25 – $f_{ck,cube} = 25 \text{ N/mm}^2$, anchor HIT-V 5.8

Data according ETA-07/0260, issue 2013-06-26									
Anchor size	M8	M10	M12	M16	M20	M24	M27	M30	
Non cracked concrete									
Tensile N_{Rk} HIT-V 5.8 [kN]	18,0	29,0	42,0	70,6	111,9	153,7	187,8	224,0	
Shear V_{Rk} HIT-V 5.8 [kN]	9,0	15,0	21,0	39,0	61,0	88,0	115,0	140,0	
Cracked concrete									
Tensile N_{Rk} HIT-V 5.8 [kN]	16,1	22,6	31,1	44,0	74,8	109,6	132,3	152,7	
Shear V_{Rk} HIT-V 5.8 [kN]	9,0	15,0	21,0	39,0	61,0	88,0	115,0	140,0	

Design resistance: concrete C 20/25 – $f_{ck,cube} = 25 \text{ N/mm}^2$, anchor HIT-V 5.8

Data according ETA-07/0260, issue 2013-06-26									
Anchor size	M8	M10	M12	M16	M20	M24	M27	M30	
Non cracked concrete									
Tensile N_{Rd} HIT-V 5.8 [kN]	12,0	19,3	28,0	33,6	53,3	73,2	89,4	106,7	
Shear V_{Rd} HIT-V 5.8 [kN]	7,2	12,0	16,8	31,2	48,8	70,4	92,0	112,0	
Cracked concrete									
Tensile N_{Rd} HIT-V 5.8 [kN]	8,9	12,6	17,3	20,9	35,6	52,2	63,0	72,7	
Shear V_{Rd} HIT-V 5.8 [kN]	7,2	12,0	16,8	31,2	48,8	70,4	92,0	112,0	

Recommended loads ^{a)}: concrete C 20/25 – $f_{ck,cube} = 25 \text{ N/mm}^2$, anchor HIT-V 5.8

			Data according ETA-07/0260, issue 2013-06-26							
Anchor size			M8	M10	M12	M16	M20	M24	M27	M30
Non cracked concrete										
Tensile N_{rec}	HIT-V 5.8	[kN]	8,6	13,8	20,0	24,0	38,1	52,3	63,9	76,2
Shear V_{rec}	HIT-V 5.8	[kN]	5,1	8,6	12,0	22,3	34,9	50,3	65,7	80,0
Cracked concrete										
Tensile N_{rec}	HIT-V 5.8	[kN]	6,4	9,0	12,3	15,0	25,4	37,3	45,0	51,9
Shear V_{rec}	HIT-V 5.8	[kN]	5,1	8,6	12,0	22,3	34,9	50,3	65,7	80,0

a) With overall partial safety factor for action $\gamma = 1,4$. The partial safety factors for action depend on the type of loading and shall be taken from national regulations.

Service temperature range

Hilti HIT-RE 500-SD injection mortar may be applied in the temperature ranges given below. An elevated base material temperature may lead to a reduction of the design bond resistance.

Temperature range	Base material temperature	Maximum long term base material temperature	Maximum short term base material temperature
Temperature range I	-40 °C to +40 °C	+24 °C	+40 °C
Temperature range II	-40 °C to +58 °C	+35 °C	+58 °C
Temperature range III	-40 °C to +70 °C	+43 °C	+70 °C

Max short term base material temperature

Short-term elevated base material temperatures are those that occur over brief intervals, e.g. as a result of diurnal cycling.

Max long term base material temperature

Long-term elevated base material temperatures are roughly constant over significant periods of time.

Materials

Mechanical properties of HIT-V / HAS

			Data according ETA-07/0260, issue 2013-06-26							
Anchor size			M8	M10	M12	M16	M20	M24	M27	M30
Nominal tensile strength f_{uk}	HIT-V 5.8	[N/mm ²]	500	500	500	500	500	500	500	500
	HIT-V 8.8	[N/mm ²]	800	800	800	800	800	800	800	800
	HIT-V-R	[N/mm ²]	700	700	700	700	700	700	500	500
	HIT-V-HCR	[N/mm ²]	800	800	800	800	800	700	700	700
Yield strength f_{yk}	HIT-V 5.8	[N/mm ²]	400	400	400	400	400	400	400	400
	HIT-V 8.8	[N/mm ²]	640	640	640	640	640	640	640	640
	HIT-V -R	[N/mm ²]	450	450	450	450	450	450	210	210
	HIT-V -HCR	[N/mm ²]	600	600	600	600	600	400	400	400
Stressed cross-section A_s	HIT-V	[mm ²]	36,6	58,0	84,3	157	245	353	459	561
Moment of resistance W	HIT-V	[mm ³]	31,2	62,3	109	277	541	935	1387	1874

Material quality

Part	Material
Threaded rod HIT-V(F) 5.8	Strength class 5.8, A ₅ > 8% ductile steel galvanized ≥ 5 μm, (F) hot dipped galvanized ≥ 45 μm,
Threaded rod HIT-V(F) 8.8	Strength class 8.8, A ₅ > 8% ductile steel galvanized ≥ 5 μm, (F) hot dipped galvanized ≥ 45 μm,
Threaded rod HIT-V-R	Stainless steel grade A4, A ₅ > 8% ductile strength class 70 for ≤ M24 and class 50 for M27 to M30, 1.4401; 1.4404; 1.4578; 1.4571; 1.4439; 1.4362
Threaded rod HIT-V-HCR	High corrosion resistant steel, 1.4529; 1.4565 strength ≤ M20: R _m = 800 N/mm ² , R _{p0.2} = 640 N/mm ² , A ₅ > 8% ductile M24 to M30: R _m = 700 N/mm ² , R _{p0.2} = 400 N/mm ² , A ₅ > 8% ductile
Washer ISO 7089	Steel galvanized, hot dipped galvanized
	Stainless steel, 1.4401; 1.4404; 1.4578; 1.4571; 1.4439; 1.4362
	High corrosion resistant steel, 1.4529; 1.4565
Nut EN ISO 4032	Strength class 8, steel galvanized ≥ 5 μm, hot dipped galvanized ≥ 45 μm
	Strength class 70, stainless steel grade A4, 1.4401; 1.4404; 1.4578; 1.4571; 1.4439; 1.4362
	Strength class 70, high corrosion resistant steel, 1.4529; 1.4565

Anchor dimensions

Anchor size	M8	M10	M12	M16	M20	M24	M27	M30
Anchor embedment depth [mm]	80	90	110	125	170	210	240	270
Anchor rod HIT-V, HIT-V-R, HIT-V-HCR	Anchor rods HIT-V (-R / -HCR) are available in variable length							

Setting

installation equipment

Anchor size	M8	M10	M12	M16	M20	M24	M27	M30
Rotary hammer	TE2 – TE16				TE40 – TE70			
Other tools	compressed air gun or blow out pump, set of cleaning brushes, dispenser							

Setting instruction

Bore hole drilling

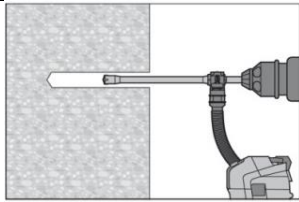

Drill hole to the required embedment depth with an appropriately sized Hilti TE-CD or TE-YD hollow drill bit with Hilti vacuum attachment. This drilling system removes the dust and cleans the borehole during drilling when using in accordance with the user's manual.

After drilling is complete, proceed to the "injection preparation" step in the instructions for use.

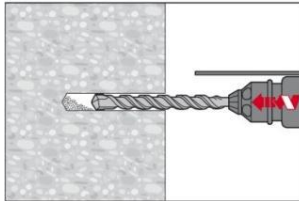

Drill Hole to the required embedment depth with a hammer drill set in rotation-hammer mode using an appropriately sized carbide drill bit.

Bore hole cleaning Just before setting an anchor, the bore hole must be free of dust and debris.

Compressed air cleaning (CAC) for all bore hole diameters d_0 and all bore hole depth h_0

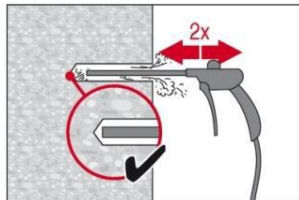

Blow 2 times from the back of the hole (if needed with nozzle extension) over the hole length with oil-free compressed air (min. 6 bar at 6 m³/h) until return air stream is free of noticeable dust.

Bore hole diameter ≥ 32 mm the compressor must supply a minimum air flow of 140 m³/hour.

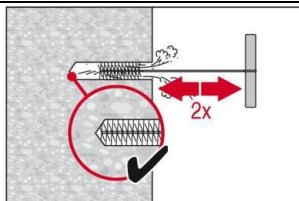

Brush 2 times with the specified brush size by inserting the steel brush Hilti HIT-RB to the back of the hole (if needed with extension) in a twisting motion and removing it.

The brush must produce natural resistance as it enters the bore hole -- if not the brush is too small and must be replaced with the proper brush diameter.

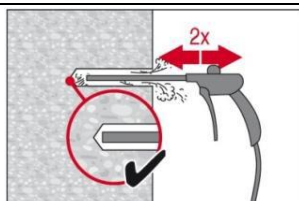

Blow again with compressed air 2 times until return air stream is free of noticeable dust.

Injection preparation

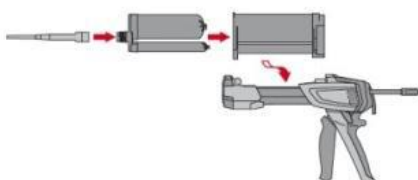

Tightly attach new Hilti mixing nozzle HIT-RE-M to foil pack manifold (snug fit). Do not modify the mixing nozzle.

Observe the instruction for use of the dispenser and the mortar. Check foil pack holder for proper function. Do not use damaged foil packs / holders. Insert foil pack into foil pack holder and put holder into HIT-dispenser.

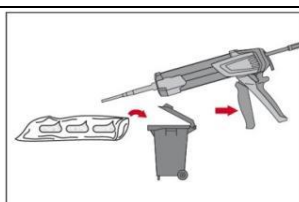

The foil pack opens automatically as dispensing is initiated. Discard initial adhesive. Depending on the size of the foil pack an initial amount of adhesive has to be discarded.

Discard quantities are:

- 3 strokes for 330 ml foil pack,
- 4 strokes for 500 ml foil pack,
- 65 ml for 1400 ml foil pack $\leq 5^\circ\text{C}$.

Inject adhesive from the back of the borehole without forming air voids

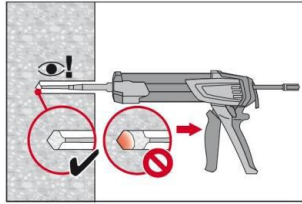

Inject the adhesive starting at the back of the hole, slowly withdrawing the mixer with each trigger pull. Fill holes approximately 2/3 full. It is required that the annular gap between the anchor and the concrete is completely filled with adhesive along the embedment length.

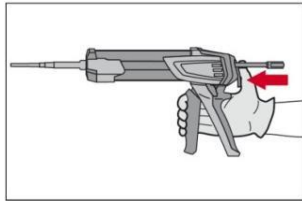

After injection is completed, depressurize the dispenser by pressing the release trigger. This will prevent further adhesive discharge from the mixer.

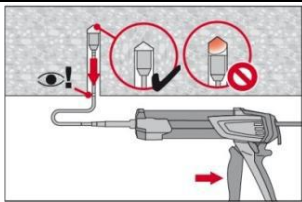

Overhead installation and/or installation with embedment depth $h_{ef} > 250\text{mm}$. For overhead installation the injection is only possible with the aid of extensions and piston plugs. Assemble HIT-RE-M mixer, extension(s) and appropriately sized piston plug (HIT-SZ). Insert piston plug to back of the hole and inject adhesive. During injection the piston plug will be naturally extruded out of the bore hole by the adhesive pressure.

Setting the element

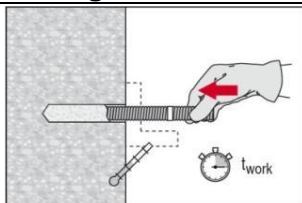

Before use, verify that the element is dry and free of oil and other contaminants. Mark and set element to the required embedment depth until working time t_{work} has elapsed.

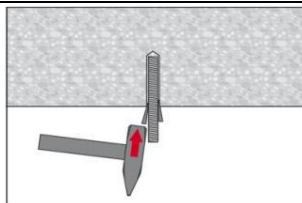

For overhead installation use piston plugs and fix embedded parts with e.g. wedges HIT-OHW.

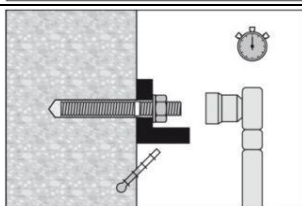

Loading the anchor:
After required curing time t_{cure} the anchor can be loaded. The applied installation torque shall not exceed given T_{max} .

For detailed information on installation see instruction for use given with the package of the product.

Curing time for general conditions

Data according ETA-07/0260, issue 2013-06-26		
Temperature of the base material	Working time in which anchor can be inserted and adjusted t_{gel}	Curing time before anchor can be fully loaded t_{cure}
40 °C	12 min	4 h
30 °C to 39 °C	12 min	8 h
20 °C to 29 °C	20 min	12 h
15 °C to 19 °C	30 min	24 h
10 °C to 14 °C	90 min	48 h
5 °C to 9 °C	120 min	72 h

Setting details

			Data according ETA-07/0260, issue 2013-06-26							
Anchor size			M8	M10	M12	M16	M20	M24	M27	M30
Nominal diameter of drill bit	d_0	[mm]	10	12	14	18	24	28	30	35
Effective anchorage and drill hole depth range ^{a)}	$h_{ef,min}$	[mm]	40	40	48	64	80	96	108	120
	$h_{ef,max}$	[mm]	160	200	240	320	400	480	540	600
Minimum base material thickness	h_{min}	[mm]	$h_{ef} + 30 \text{ mm}$ $\geq 100 \text{ mm}$			$h_{ef} + 2 d_0$				
Diameter of clearance hole in the fixture	d_f	[mm]	9	12	14	18	22	26	30	33
Minimum spacing	s_{min}	[mm]	40	50	60	80	100	120	135	150
Minimum edge distance	c_{min}	[mm]	40	50	60	80	100	120	135	150
Critical spacing for splitting failure	$s_{cr,sp}$		$2 c_{cr,sp}$							
Critical edge distance for splitting failure ^{b)}	$c_{cr,sp}$	[mm]	$1,0 \cdot h_{ef}$ for $h / h_{ef} \geq 2,0$							
			$4,6 h_{ef} - 1,8 h$ for $2,0 > h / h_{ef} > 1,3$							
			$2,26 h_{ef}$ for $h / h_{ef} \leq 1,3$							
Critical spacing for concrete cone failure	$s_{cr,N}$		$2 c_{cr,N}$							
Critical edge distance for concrete cone failure ^{c)}	$c_{cr,N}$		$1,5 h_{ef}$							
Torque moment ^{d)}	T_{max}	[Nm]	10	20	40	80	150	200	270	300

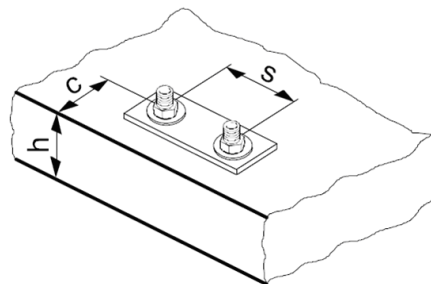

For spacing (edge distance) smaller than critical spacing (critical edge distance) the design loads have to be reduced.

- a) $h_{ef,min} \leq h_{ef} \leq h_{ef,max}$ (h_{ef} : embedment depth)
- b) h : base material thickness ($h \geq h_{min}$)
- c) The critical edge distance for concrete cone failure depends on the embedment depth h_{ef} and the design bond resistance. The simplified formula given in this table is on the safe side.
- d) This is the maximum recommended torque moment to avoid splitting failure during installation for anchors with minimum spacing and/or edge distance.

Simplified design method

Simplified version of the design method according ETAG 001, TR 029. Design resistance according data given in ETA-07/0260, issue 2013-06-26.

- Influence of concrete strength
- Influence of edge distance
- Influence of spacing
- Valid for a group of two anchors. (The method may also be applied for anchor groups with more than two anchors or more than one edge distance. The influencing factors must then be considered for each edge distance and spacing. The calculated design loads are then on the save side: They will be lower than the exact values according ETAG 001, TR 029. To avoid this, it is recommended to use the anchor design software PROFIS anchor)

The design method is based on the following simplification:

- No different loads are acting on individual anchors (no eccentricity)

The values are valid for one anchor.

For more complex fastening applications please use the anchor design software PROFIS Anchor.

Tension loading

The design tensile resistance is the lower value of

- Steel resistance: $N_{Rd,s}$
- Combined pull-out and concrete cone resistance: $N_{Rd,p} = N_{Rd,p}^0 \cdot f_{B,p} \cdot f_{1,N} \cdot f_{2,N} \cdot f_{3,N} \cdot f_{h,p} \cdot f_{re,N}$
- Concrete cone resistance: $N_{Rd,c} = N_{Rd,c}^0 \cdot f_B \cdot f_{1,N} \cdot f_{2,N} \cdot f_{3,N} \cdot f_{h,N} \cdot f_{re,N}$
- Concrete splitting resistance (only non-cracked concrete): $N_{Rd,sp} = N_{Rd,c}^0 \cdot f_B \cdot f_{1,sp} \cdot f_{2,sp} \cdot f_{3,sp} \cdot f_{h,N} \cdot f_{re,N}$

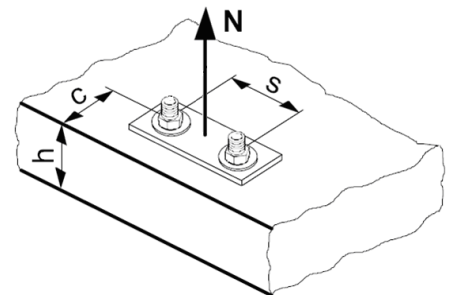

Basic design tensile resistance

Design steel resistance $N_{Rd,s}$

		Data according ETA-07/0260, issue 2013-06-26							
Anchor size		M8	M10	M12	M16	M20	M24	M27	M30
$N_{Rd,s}$	HIT-V 5.8 [kN]	12,0	19,3	28,0	52,7	82,0	118,0	153,3	187,3
	HIT-V 8.8 [kN]	19,3	30,7	44,7	84,0	130,7	188,0	244,7	299,3
	HIT-V-R [kN]	13,9	21,9	31,6	58,8	92,0	132,1	80,4	98,3
	HIT-V-HCR [kN]	19,3	30,7	44,7	84,0	130,7	117,6	152,9	187,1

Design combined pull-out and concrete cone resistance

$$N_{Rd,p} = N_{Rd,p}^0 \cdot f_{B,p} \cdot f_{1,N} \cdot f_{2,N} \cdot f_{3,N} \cdot f_{h,p} \cdot f_{re,N}$$

	Data according ETA-07/0260, issue 2013-06-26							
Anchor size	M8	M10	M12	M16	M20	M24	M27	M30
Typical embedment depth $h_{ef,typ}$ [mm]	80	90	110	125	170	210	240	270
Non cracked concrete								
$N_{Rd,p}^0$ Temperature range I [kN]	17,9	25,1	36,9	44,9	76,3	105,6	135,7	157,5
$N_{Rd,p}^0$ Temperature range II [kN]	14,5	20,4	29,9	35,9	61,0	82,9	106,6	133,3
$N_{Rd,p}^0$ Temperature range III [kN]	8,9	12,6	18,4	22,4	35,6	52,8	63,0	78,8
Cracked concrete								
$N_{Rd,p}^0$ Temperature range I [kN]	8,9	12,6	17,3	20,9	35,6	52,8	63,0	72,7
$N_{Rd,p}^0$ Temperature range II [kN]	7,3	9,4	13,8	18,0	28,0	41,5	48,5	60,6
$N_{Rd,p}^0$ Temperature range III [kN]	4,5	5,5	8,1	10,5	15,3	22,6	29,1	36,4

$$\text{Design concrete cone resistance } N_{Rd,c} = N_{Rd,c}^0 \cdot f_B \cdot f_{1,N} \cdot f_{2,N} \cdot f_{3,N} \cdot f_{h,N} \cdot f_{re,N}$$

$$\text{Design splitting resistance }^a) N_{Rd,sp} = N_{Rd,c}^0 \cdot f_B \cdot f_{1,sp} \cdot f_{2,sp} \cdot f_{3,sp} \cdot f_{h,N} \cdot f_{re,N}$$

	Data according ETA-07/0260, issue 2013-06-26							
Anchor size	M8	M10	M12	M16	M20	M24	M27	M30
$N_{Rd,c}^0$ Non cracked concrete [kN]	20,1	24,0	32,4	33,6	53,3	73,2	89,4	106,7
$N_{Rd,c}^0$ Cracked concrete [kN]	14,3	17,1	23,1	24,0	38,0	52,2	63,7	76,1

a) Splitting resistance must only be considered for non-cracked concrete

Influencing factors

Influence of concrete strength on combined pull-out and concrete cone resistance

Concrete strength designation (ENV 206)	C 20/25	C 25/30	C 30/37	C 35/45	C 40/50	C 45/55	C 50/60
$f_{B,p} = (f_{ck,cube}/25N/mm^2)^{0,1}$ ^{a)}	1	1,02	1,04	1,06	1,07	1,08	1,09

a) $f_{ck,cube}$ = concrete compressive strength, measured on cubes with 150 mm side length

Influence of embedment depth on combined pull-out and concrete cone resistance

$$f_{h,p} = h_{ef}/h_{ef,typ}$$

Influence of concrete strength on concrete cone resistance

Concrete strength designation (ENV 206)	C 20/25	C 25/30	C 30/37	C 35/45	C 40/50	C 45/55	C 50/60
$f_B = (f_{ck,cube}/25N/mm^2)^{1/2}$ ^{a)}	1	1,1	1,22	1,34	1,41	1,48	1,55

a) $f_{ck,cube}$ = concrete compressive strength, measured on cubes with 150 mm side length

Influence of edge distance ^{a)}

$c/c_{cr,N}$	0,1	0,2	0,3	0,4	0,5	0,6	0,7	0,8	0,9	1
$c/c_{cr,sp}$										
$f_{1,N} = 0,7 + 0,3 \cdot c/c_{cr,N}$	0,73	0,76	0,79	0,82	0,85	0,88	0,91	0,94	0,97	1
$f_{1,sp} = 0,7 + 0,3 \cdot c/c_{cr,sp}$										
$f_{2,N} = 0,5 \cdot (1 + c/c_{cr,N})$	0,55	0,60	0,65	0,70	0,75	0,80	0,85	0,90	0,95	1
$f_{2,sp} = 0,5 \cdot (1 + c/c_{cr,sp})$										

a) The edge distance shall not be smaller than the minimum edge distance c_{min} given in the table with the setting details. These influencing factors must be considered for every edge distance smaller than the critical edge distance.

Influence of anchor spacing ^{a)}

$s/s_{cr,N}$	0,1	0,2	0,3	0,4	0,5	0,6	0,7	0,8	0,9	1
$s/s_{cr,sp}$										
$f_{3,N} = 0,5 \cdot (1 + s/s_{cr,N})$	0,55	0,60	0,65	0,70	0,75	0,80	0,85	0,90	0,95	1
$f_{3,sp} = 0,5 \cdot (1 + s/s_{cr,sp})$										

a) The anchor spacing shall not be smaller than the minimum anchor spacing s_{min} given in the table with the setting details. This influencing factor must be considered for every anchor spacing.

Influence of embedment depth on concrete cone resistance

$$f_{h,N} = (h_{ef}/h_{ef,typ})^{1,5}$$

Influence of reinforcement

h_{ef} [mm]	40	50	60	70	80	90	≥ 100
$f_{re,N} = 0,5 + h_{ef}/200mm \leq 1$	0,7 ^{a)}	0,75 ^{a)}	0,8 ^{a)}	0,85 ^{a)}	0,9 ^{a)}	0,95 ^{a)}	1

a) This factor applies only for dense reinforcement. If in the area of anchorage there is reinforcement with a spacing ≥ 150 mm (any diameter) or with a diameter ≤ 10 mm and a spacing ≥ 100 mm, then a factor $f_{re} = 1$ may be applied.

Shear loading

The design shear resistance is the lower value of

- Steel resistance: $V_{Rd,s}$
- Concrete pryout resistance: $V_{Rd,cp} = k \cdot \text{lower value of } N_{Rd,p} \text{ and } N_{Rd,c}$
- Concrete edge resistance: $V_{Rd,c} = V_{Rd,c}^0 \cdot f_B \cdot f_{\beta} \cdot f_h \cdot f_4 \cdot f_{hef} \cdot f_c$

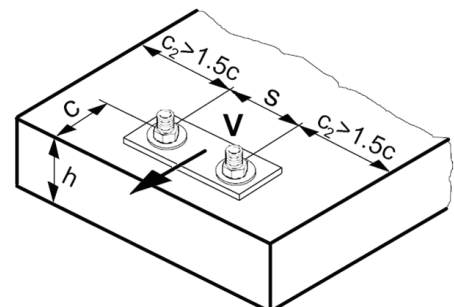

Basic design shear resistance

Design steel resistance $V_{Rd,s}$

			Data according ETA-07/0260, issue 2013-06-26							
Anchor size			M8	M10	M12	M16	M20	M24	M27	M30
$V_{Rd,s}$	HIT-V 5.8	[kN]	7,2	12,0	16,8	31,2	48,8	70,4	92,0	112,0
	HIT-V 8.8	[kN]	12,0	18,4	27,2	50,4	78,4	112,8	147,2	179,2
	HIT-V-R	[kN]	8,3	12,8	19,2	35,3	55,1	79,5	48,3	58,8
	HIT-V-HCR	[kN]	12,0	18,4	27,2	50,4	78,4	70,9	92,0	112,0

Design concrete pryout resistance $V_{Rd,cp}$ = lower value^{a)} of $k \cdot N_{Rd,p}$ and $k \cdot N_{Rd,c}$

$k = 1$ for $h_{ef} < 60$ mm

$k = 2$ for $h_{ef} \geq 60$ mm

- a) $N_{Rd,p}$: Design combined pull-out and concrete cone resistance
 $N_{Rd,c}$: Design concrete cone resistance

Design concrete edge resistance $V_{Rd,c} = V_{Rd,c}^0 \cdot f_B \cdot f_h \cdot f_4 \cdot f_{hef} \cdot f_c$

Anchor size		M8	M10	M12	M16	M20	M24	M27	M30
Non-cracked concrete									
$V_{Rd,c}^0$	[kN]	5,9	8,6	11,6	18,7	27,0	36,6	44,5	53,0
Cracked concrete									
$V_{Rd,c}^0$	[kN]	4,2	6,1	8,2	13,2	19,2	25,9	31,5	37,5

Influencing factors

Influence of concrete strength

Concrete strength designation (ENV 206)	C 20/25	C 25/30	C 30/37	C 35/45	C 40/50	C 45/55	C 50/60
$f_B = (f_{ck,cube}/25N/mm^2)^{1/2}$ a)	1	1,1	1,22	1,34	1,41	1,48	1,55

- a) $f_{ck,cube}$ = concrete compressive strength, measured on cubes with 150 mm side length

Influence of angle between load applied and the direction perpendicular to the free edge

Angle β	0°	10°	20°	30°	40°	50°	60°	70°	80°	≥ 90°
$f_\beta = \frac{1}{\sqrt{(\cos \alpha_v)^2 + \left(\frac{\sin \alpha_v}{2,5}\right)^2}}$	1	1,01	1,05	1,13	1,24	1,40	1,64	1,97	2,32	2,50

Influence of base material thickness

h/c	0,15	0,3	0,45	0,6	0,75	0,9	1,05	1,2	1,35	≥ 1,5
$f_h = \{h/(1,5 \cdot c)\}^{1/2} \leq 1$	0,32	0,45	0,55	0,63	0,71	0,77	0,84	0,89	0,95	1,00

Influence of anchor spacing and edge distance ^{a)} for concrete edge resistance: f_4

$$f_4 = (c/h_{ef})^{1,5} \cdot (1 + s / [3 \cdot c]) \cdot 0,5$$

c/h _{ef}	Single anchor	Group of two anchors s/h _{ef}														
		0,75	1,50	2,25	3,00	3,75	4,50	5,25	6,00	6,75	7,50	8,25	9,00	9,75	10,50	11,25
0,50	0,35	0,27	0,35	0,35	0,35	0,35	0,35	0,35	0,35	0,35	0,35	0,35	0,35	0,35	0,35	0,35
0,75	0,65	0,43	0,54	0,65	0,65	0,65	0,65	0,65	0,65	0,65	0,65	0,65	0,65	0,65	0,65	0,65
1,00	1,00	0,63	0,75	0,88	1,00	1,00	1,00	1,00	1,00	1,00	1,00	1,00	1,00	1,00	1,00	1,00
1,25	1,40	0,84	0,98	1,12	1,26	1,40	1,40	1,40	1,40	1,40	1,40	1,40	1,40	1,40	1,40	1,40
1,50	1,84	1,07	1,22	1,38	1,53	1,68	1,84	1,84	1,84	1,84	1,84	1,84	1,84	1,84	1,84	1,84
1,75	2,32	1,32	1,49	1,65	1,82	1,98	2,15	2,32	2,32	2,32	2,32	2,32	2,32	2,32	2,32	2,32
2,00	2,83	1,59	1,77	1,94	2,12	2,30	2,47	2,65	2,83	2,83	2,83	2,83	2,83	2,83	2,83	2,83
2,25	3,38	1,88	2,06	2,25	2,44	2,63	2,81	3,00	3,19	3,38	3,38	3,38	3,38	3,38	3,38	3,38
2,50	3,95	2,17	2,37	2,57	2,77	2,96	3,16	3,36	3,56	3,76	3,95	3,95	3,95	3,95	3,95	3,95
2,75	4,56	2,49	2,69	2,90	3,11	3,32	3,52	3,73	3,94	4,15	4,35	4,56	4,56	4,56	4,56	4,56
3,00	5,20	2,81	3,03	3,25	3,46	3,68	3,90	4,11	4,33	4,55	4,76	4,98	5,20	5,20	5,20	5,20
3,25	5,86	3,15	3,38	3,61	3,83	4,06	4,28	4,51	4,73	4,96	5,18	5,41	5,63	5,86	5,86	5,86
3,50	6,55	3,51	3,74	3,98	4,21	4,44	4,68	4,91	5,14	5,38	5,61	5,85	6,08	6,31	6,55	6,55
3,75	7,26	3,87	4,12	4,36	4,60	4,84	5,08	5,33	5,57	5,81	6,05	6,29	6,54	6,78	7,02	7,26
4,00	8,00	4,25	4,50	4,75	5,00	5,25	5,50	5,75	6,00	6,25	6,50	6,75	7,00	7,25	7,50	7,75
4,25	8,76	4,64	4,90	5,15	5,41	5,67	5,93	6,18	6,44	6,70	6,96	7,22	7,47	7,73	7,99	8,25
4,50	9,55	5,04	5,30	5,57	5,83	6,10	6,36	6,63	6,89	7,16	7,42	7,69	7,95	8,22	8,49	8,75
4,75	10,35	5,45	5,72	5,99	6,27	6,54	6,81	7,08	7,36	7,63	7,90	8,17	8,45	8,72	8,99	9,26
5,00	11,18	5,87	6,15	6,43	6,71	6,99	7,27	7,55	7,83	8,11	8,39	8,66	8,94	9,22	9,50	9,78
5,25	12,03	6,30	6,59	6,87	7,16	7,45	7,73	8,02	8,31	8,59	8,88	9,17	9,45	9,74	10,02	10,31
5,50	12,90	6,74	7,04	7,33	7,62	7,92	8,21	8,50	8,79	9,09	9,38	9,67	9,97	10,26	10,55	10,85

a) The anchor spacing and the edge distance shall not be smaller than the minimum anchor spacing s_{min} and the minimum edge distance c_{min} .

Influence of embedment depth

h _{ef} /d	4	4,5	5	6	7	8	9	10	11
f _{hef} = 0,05 · (h _{ef} / d) ^{1,68}	0,51	0,63	0,75	1,01	1,31	1,64	2,00	2,39	2,81
h _{ef} /d	12	13	14	15	16	17	18	19	20
f _{hef} = 0,05 · (h _{ef} / d) ^{1,68}	3,25	3,72	4,21	4,73	5,27	5,84	6,42	7,04	7,67

Influence of edge distance ^{a)}

c/d	4	6	8	10	15	20	30	40
f _c = (d / c) ^{0,19}	0,77	0,71	0,67	0,65	0,60	0,57	0,52	0,50

a) The edge distance shall not be smaller than the minimum edge distance c_{min} .

Combined tension and shear loading

For combined tension and shear loading see section "Anchor Design".

Precalculated values

Recommended loads can be calculated by dividing the design resistance by an overall partial safety factor for action $\gamma = 1,4$. The partial safety factors for action depend on the type of loading and shall be taken from national regulations.

Design resistance: concrete C 20/25 – $f_{ck,cube} = 25 \text{ N/mm}^2$, Temperature range I

		Data according ETA-07/0260, issue 2013-06-26							
Anchor size		M8	M10	M12	M16	M20	M24	M27	M30
Embedment depth $h_{ef,1} =$ [mm]		48	60	72	96	120	144	162	180
Base material thickness $h_{min} =$ [mm]		100	100	102	132	168	200	222	250
Tensile N_{Rd}: single anchor, no edge effects									
Non cracked concrete									
HIT-V 5.8									
HIT-V 8.8									
HIT-V-R	[kN]	9,3	13,0	17,1	22,6	31,6	41,6	49,6	58,1
HIT-V-HCR									
Cracked concrete									
HIT-V 5.8									
HIT-V 8.8									
HIT-V-R	[kN]	5,4	8,4	11,3	16,1	22,5	29,6	35,3	41,4
HIT-V-HCR									
Shear V_{Rd}: single anchor, no edge effects, without lever arm									
Non cracked concrete									
HIT-V 5.8	[kN]	7,2	12,0	16,8	31,2	48,8	70,4	92,0	112,0
HIT-V 8.8	[kN]	11,2	18,4	27,2	50,4	78,4	112,8	138,8	162,6
HIT-V-R	[kN]	8,3	12,8	19,2	35,3	55,1	79,5	48,3	58,8
HIT-V-HCR	[kN]	11,2	18,4	27,2	50,4	78,4	70,9	92,0	112,0
Cracked concrete									
HIT-V 5.8	[kN]	6,4	12,0	16,8	31,2	48,8	70,4	92,0	112,0
HIT-V 8.8	[kN]	6,4	18,4	27,1	45,0	63,1	82,9	99,0	115,9
HIT-V-R	[kN]	6,4	12,8	19,2	35,3	55,1	79,5	48,3	58,8
HIT-V-HCR	[kN]	6,4	18,4	27,1	45,0	63,1	70,9	92,0	112,0

Design resistance: concrete C 20/25 – $f_{ck,cube} = 25 \text{ N/mm}^2$, Temperature range I

		Data according ETA-07/0260, issue 2013-06-26							
Anchor size		M8	M10	M12	M16	M20	M24	M27	M30
Embedment depth $h_{ef,1} =$ [mm]		48	60	72	96	120	144	162	180
Base material thickness $h_{min} =$ [mm]		100	100	102	132	168	200	222	250
Edge distance $c = c_{min} =$ [mm]		40	50	60	80	100	120	135	150
Tensile N_{Rd}: single anchor, min. edge distance ($c = c_{min}$)									
Non cracked concrete									
HIT-V 5.8									
HIT-V 8.8									
HIT-V-R	[kN]	6,3	8,5	9,9	12,9	18,2	23,8	28,2	33,2
HIT-V-HCR									
Cracked concrete									
HIT-V 5.8									
HIT-V 8.8									
HIT-V-R	[kN]	3,6	5,6	7,1	9,2	12,9	16,9	20,1	23,7
HIT-V-HCR									
Shear V_{Rd}: single anchor, min. edge distance ($c = c_{min}$), without lever arm									
Non cracked concrete									
HIT-V 5.8									
HIT-V 8.8									
HIT-V-R	[kN]	3,4	4,9	6,7	10,8	15,7	21,4	26,0	31,1
HIT-V-HCR									
Cracked concrete									
HIT-V 5.8									
HIT-V 8.8									
HIT-V-R	[kN]	2,4	3,5	4,7	7,6	11,1	15,1	18,4	22,0
HIT-V-HCR									

Design resistance: concrete C 20/25 – $f_{ck,cube} = 25 \text{ N/mm}^2$, Temperature range I
(load values are valid for single anchor)

		Data according ETA-07/0260, issue 2013-06-26								
Anchor size		M8	M10	M12	M16	M20	M24	M27	M30	
Embedment depth	$h_{ef,1} = [\text{mm}]$	48	60	72	96	120	144	162	180	
Base material thickness	$h_{min} = [\text{mm}]$	100	100	102	132	168	200	222	250	
Spacing	$s = s_{min} = [\text{mm}]$	40	50	60	80	100	120	135	150	
Tensile N_{Rd}: double anchor, no edge effects, min. spacing ($s = s_{min}$)										
Non cracked concrete										
HIT-V 5.8										
HIT-V 8.8										
HIT-V-R		[kN]	6,0	8,2	10,3	13,5	19,0	24,9	29,6	34,8
HIT-V-HCR										
Cracked concrete										
HIT-V 5.8										
HIT-V 8.8										
HIT-V-R		[kN]	3,6	5,5	7,4	9,6	13,5	17,8	21,1	24,8
HIT-V-HCR										
Shear V_{Rd}: double anchor, no edge effects, min. spacing ($s = s_{min}$), without lever arm										
Non cracked concrete										
HIT-V 5.8		[kN]	7,2	12,0	16,8	31,2	48,8	70,4	88,7	103,9
HIT-V 8.8		[kN]	7,2	18,4	26,3	40,5	56,5	74,3	88,7	103,9
HIT-V-R		[kN]	7,2	12,8	19,2	35,3	55,1	74,3	48,3	58,8
HIT-V-HCR		[kN]	7,2	18,4	26,3	40,5	56,5	70,9	88,7	103,9
Cracked concrete										
HIT-V 5.8		[kN]	4,1	12,0	16,8	28,8	40,3	53,0	63,2	74,1
HIT-V 8.8		[kN]	4,1	12,8	17,3	28,8	40,3	53,0	63,2	74,1
HIT-V-R		[kN]	4,1	12,8	17,3	28,8	40,3	53,0	48,3	58,8
HIT-V-HCR		[kN]	4,1	12,8	17,3	28,8	40,3	53,0	63,2	74,1

Design resistance: concrete C 20/25 – $f_{ck,cube} = 25 \text{ N/mm}^2$, Temperature range I

		Data according ETA-07/0260, issue 2013-06-26								
Anchor size		M8	M10	M12	M16	M20	M24	M27	M30	
Embedment depth	$h_{ef,typ} = [\text{mm}]$	80	90	110	125	170	210	240	270	
Base material thickness	$h_{min} = [\text{mm}]$	110	120	140	161	218	266	300	340	
Tensile N_{Rd}: single anchor, no edge effects										
Non cracked concrete										
HIT-V 5.8		[kN]	12,0	19,3	28,0	33,6	53,3	73,2	89,4	106,7
HIT-V 8.8		[kN]	17,9	24,0	32,4	33,6	53,3	73,2	89,4	106,7
HIT-V-R		[kN]	13,9	21,9	31,6	33,6	53,3	73,2	80,4	98,3
HIT-V-HCR		[kN]	17,9	24,0	32,4	33,6	53,3	73,2	89,4	106,7
Cracked concrete										
HIT-V 5.8										
HIT-V 8.8		[kN]	8,9	12,6	17,3	20,9	35,6	52,2	63,0	72,7
HIT-V-R										
HIT-V-HCR										
Shear V_{Rd}: single anchor, no edge effects, without lever arm										
Non cracked concrete										
HIT-V 5.8		[kN]	7,2	12,0	16,8	31,2	48,8	70,4	92,0	112,0
HIT-V 8.8		[kN]	12,0	18,4	27,2	50,4	78,4	112,8	147,2	179,2
HIT-V-R		[kN]	8,3	12,8	19,2	35,3	55,1	79,5	48,3	58,8
HIT-V-HCR		[kN]	12,0	18,4	27,2	50,4	78,4	70,9	92,0	112,0
Cracked concrete										
HIT-V 5.8		[kN]	7,2	12,0	16,8	31,2	48,8	70,4	92,0	112,0
HIT-V 8.8		[kN]	12,0	18,4	27,2	50,4	78,4	112,8	147,2	179,2
HIT-V-R		[kN]	8,3	12,8	19,2	35,3	55,1	79,5	48,3	58,8
HIT-V-HCR		[kN]	12,0	18,4	27,2	41,9	71,2	70,9	92,0	112,0

Design resistance: concrete C 20/25 – $f_{ck,cube} = 25 \text{ N/mm}^2$, Temperature range I

		Data according ETA-07/0260, issue 2013-06-26								
Anchor size		M8	M10	M12	M16	M20	M24	M27	M30	
Embedment depth	$h_{ef,typ} = [\text{mm}]$	80	90	110	125	170	210	240	270	
Base material thickness	$h_{min} = [\text{mm}]$	110	120	140	161	218	266	300	340	
Edge distance	$c = c_{min} = [\text{mm}]$	40	50	60	80	100	120	135	150	
Tensile N_{Rd}: single anchor, min. edge distance ($c = c_{min}$)										
Non cracked concrete										
HIT-V 5.8										
HIT-V 8.8										
HIT-V-R		[kN]	9,6	11,6	15,5	16,9	26,1	35,6	43,3	51,4
HIT-V-HCR										
Cracked concrete										
HIT-V 5.8										
HIT-V 8.8										
HIT-V-R		[kN]	4,8	7,0	9,5	12,1	18,6	25,4	30,8	36,7
HIT-V-HCR										
Shear V_{Rd}: single anchor, min. edge distance ($c = c_{min}$), without lever arm										
Non cracked concrete										
HIT-V 5.8										
HIT-V 8.8										
HIT-V-R		[kN]	3,7	5,3	7,3	11,5	17,2	23,6	29,0	34,8
HIT-V-HCR										
Cracked concrete										
HIT-V 5.8										
HIT-V 8.8										
HIT-V-R		[kN]	2,6	3,8	5,2	8,1	12,2	16,7	20,5	24,7
HIT-V-HCR										

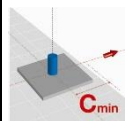
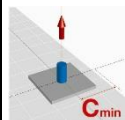

Design resistance: concrete C 20/25 – $f_{ck,cube} = 25 \text{ N/mm}^2$, Temperature range I
(load values are valid for single anchor)

		Data according ETA-07/0260, issue 2013-06-26								
Anchor size		M8	M10	M12	M16	M20	M24	M27	M30	
Embedment depth	$h_{ef,typ} = [\text{mm}]$	80	90	110	125	170	210	240	270	
Base material thickness	$h_{min} = [\text{mm}]$	110	120	140	161	218	266	300	340	
Spacing	$s = s_{min} = [\text{mm}]$	40	50	60	80	100	120	135	150	
Tensile N_{Rd}: double anchor, no edge effects, min. spacing ($s = s_{min}$)										
Non cracked concrete										
HIT-V 5.8										
HIT-V 8.8										
HIT-V-R		[kN]	10,9	13,5	18,1	19,2	30,1	41,2	50,3	59,9
HIT-V-HCR										
Cracked concrete										
HIT-V 5.8										
HIT-V 8.8										
HIT-V-R		[kN]	5,9	8,1	11,1	13,2	21,5	29,4	35,8	42,7
HIT-V-HCR										
Shear V_{Rd}: double anchor, no edge effects, min. spacing ($s = s_{min}$), without lever arm										
Non cracked concrete										
HIT-V 5.8		[kN]	7,2	12,0	16,8	31,2	48,8	70,4	92,0	112,0
HIT-V 8.8		[kN]	12,0	18,4	27,2	50,4	78,4	112,8	147,2	177,0
HIT-V-R		[kN]	8,3	12,8	19,2	35,3	55,1	79,5	48,3	58,8
HIT-V-HCR		[kN]	12,0	18,4	27,2	50,4	78,4	70,9	92,0	112,0
Cracked concrete										
HIT-V 5.8		[kN]	7,2	12,0	16,8	31,2	48,8	70,4	92,0	112,0
HIT-V 8.8		[kN]	12,0	17,9	24,5	35,6	59,6	86,9	104,8	120,6
HIT-V-R		[kN]	8,3	12,8	19,2	35,3	55,1	79,5	48,3	58,8
HIT-V-HCR		[kN]	12,0	17,9	24,5	35,6	59,6	70,9	92,0	112,0

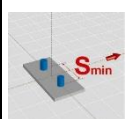
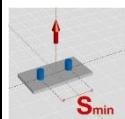

Design resistance: concrete C 20/25 – $f_{ck,cube} = 25 \text{ N/mm}^2$, Temperature range I

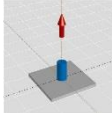
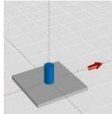
		Data according ETA-07/0260, issue 2013-06-26								
Anchor size		M8	M10	M12	M16	M20	M24	M27	M30	
Embedment depth	$h_{ef,2} = [\text{mm}]$	96	120	144	192	240	288	324	360	
Base material thickness	$h_{min} = [\text{mm}]$	126	150	174	228	288	344	384	430	
Tensile N_{Rd}: single anchor, no edge effects										
Non cracked concrete										
	HIT-V 5.8	[kN]	12,0	19,3	28,0	52,7	82,0	117,5	140,2	164,3
	HIT-V 8.8	[kN]	19,3	30,7	44,7	64,0	89,4	117,5	140,2	164,3
	HIT-V-R	[kN]	13,9	21,9	31,6	58,8	89,4	117,5	80,4	98,3
	HIT-V-HCR	[kN]	19,3	30,7	44,7	64,0	89,4	117,5	140,2	164,3
Cracked concrete										
	HIT-V 5.8	[kN]	10,7	16,8	22,6	32,2	50,3	72,4	85,1	96,9
	HIT-V 8.8	[kN]	10,7	16,8	22,6	32,2	50,3	72,4	85,1	96,9
	HIT-V-R	[kN]	10,7	16,8	22,6	32,2	50,3	72,4	80,4	96,9
	HIT-V-HCR	[kN]	10,7	16,8	22,6	32,2	50,3	72,4	85,1	96,9
Shear V_{Rd}: single anchor, no edge effects, without lever arm										
Non cracked and cracked concrete										
	HIT-V 5.8	[kN]	7,2	12,0	16,8	31,2	48,8	70,4	92,0	112,0
	HIT-V 8.8	[kN]	12,0	18,4	27,2	50,4	78,4	112,8	147,2	179,2
	HIT-V-R	[kN]	8,3	12,8	19,2	35,3	55,1	79,5	48,3	58,8
	HIT-V-HCR	[kN]	12,0	18,4	27,2	50,4	78,4	70,9	92,0	112,0

Design resistance: concrete C 20/25 – $f_{ck,cube} = 25 \text{ N/mm}^2$, Temperature range I

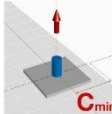
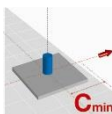
		Data according ETA-07/0260, issue 2013-06-26								
Anchor size		M8	M10	M12	M16	M20	M24	M27	M30	
Embedment depth	$h_{ef,2} = [\text{mm}]$	96	120	144	192	240	288	324	360	
Base material thickness	$h_{min} = [\text{mm}]$	126	150	174	228	288	344	384	430	
Edge distance	$c = c_{min} = [\text{mm}]$	40	50	60	80	100	120	135	150	
Tensile N_{Rd}: single anchor, min. edge distance ($c = c_{min}$)										
Non cracked concrete										
	HIT-V 5.8									
	HIT-V 8.8	[kN]	11,6	16,5	21,7	28,6	40,0	52,6	62,7	73,5
	HIT-V-R									
	HIT-V-HCR									
Cracked concrete										
	HIT-V 5.8									
	HIT-V 8.8	[kN]	5,8	9,0	12,2	17,5	27,4	37,5	44,7	52,4
	HIT-V-R									
	HIT-V-HCR									
Shear V_{Rd}: single anchor, min. edge distance ($c = c_{min}$), without lever arm										
Non cracked concrete										
	HIT-V 5.8									
	HIT-V 8.8	[kN]	3,9	5,7	7,8	12,9	18,9	25,9	31,8	38,1
	HIT-V-R									
	HIT-V-HCR									
Cracked concrete										
	HIT-V 5.8									
	HIT-V 8.8	[kN]	2,8	4,0	5,5	9,1	13,4	18,4	22,5	27,0
	HIT-V-R									
	HIT-V-HCR									

Design resistance: concrete C 20/25 – $f_{ck,cube} = 25 \text{ N/mm}^2$, Temperature range I
(load values are valid for single anchor)

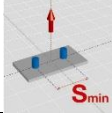
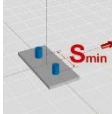
		Data according ETA-07/0260, issue 2013-06-26							
Anchor size		M8	M10	M12	M16	M20	M24	M27	M30
Embedment depth	$h_{ef,2} =$ [mm]	96	120	144	192	240	288	324	360
Base material thickness	$h_{min} =$ [mm]	126	150	174	228	288	344	384	430
Spacing	$s = s_{min} =$ [mm]	40	50	60	80	100	120	135	150
Tensile N_{Rd}: double anchor, no edge effects, min. spacing ($s = s_{min}$)									
Non cracked concrete									
	HIT-V 5.8 [kN]	12,0	19,3	26,5	34,9	48,8	64,2	76,6	89,7
	HIT-V 8.8 [kN]	13,4	20,1	26,5	34,9	48,8	64,2	76,6	89,7
	HIT-V-R [kN]	13,4	20,1	26,5	34,9	48,8	64,2	76,6	89,7
	HIT-V-HCR [kN]	13,4	20,1	26,5	34,9	48,8	64,2	76,6	89,7
Cracked concrete									
	HIT-V 5.8 [kN]	7,2	11,0	14,8	20,8	31,7	44,9	52,9	61,1
	HIT-V 8.8 [kN]								
	HIT-V-R [kN]								
	HIT-V-HCR [kN]								
Shear V_{Rd}: double anchor, no edge effects, min. spacing ($s = s_{min}$), without lever arm									
Non cracked concrete									
	HIT-V 5.8 [kN]	7,2	12,0	16,8	31,2	48,8	70,4	92,0	112,0
	HIT-V 8.8 [kN]	12,0	18,4	27,2	50,4	78,4	112,8	147,2	179,2
	HIT-V-R [kN]	8,3	12,8	19,2	35,3	55,1	79,5	48,3	58,8
	HIT-V-HCR [kN]	12,0	18,4	27,2	50,4	78,4	70,9	92,0	112,0
Cracked concrete									
	HIT-V 5.8 [kN]	7,2	12,0	16,8	31,2	48,8	70,4	92,0	112,0
	HIT-V 8.8 [kN]	12,0	18,4	27,2	50,4	78,4	112,8	135,6	154,6
	HIT-V-R [kN]	8,3	12,8	19,2	35,3	55,1	79,5	48,3	58,8
	HIT-V-HCR [kN]	12,0	18,4	27,2	50,4	78,4	70,9	92,0	112,0

Seismic design C1

Basic loading data for concrete C20/25 – C50/60

All data in this section applies to:

- Seismic design according to TR045

The following technical data are based on: ETA-07/0260, issue 2013-06-26

Anchorage depth range

Anchor size		M8	M10	M12	M16	M20	M24	M27	M30
Effective anchorage	$h_{ef,min}$ [mm]	40	40	48	64	80	96	108	120
depth range	$h_{ef,max}$ [mm]	160	200	240	320	400	480	540	600

Tension resistance in case of seismic performance category C1

Anchor size		M8	M10	M12	M16	M20	M24	M27	M30
Characteristic tension resistance to steel failure									
HIT-V-5.8(F)	$N_{Rk,s,seis}$ [kN]	18	29	42	79	123	177	230	281
HIT-V-8.8(F)	$N_{Rk,s,seis}$ [kN]	29	46	67	126	196	282	367	449
Partial safety factor	$\gamma_{Ms,seis}$ [-]	1,5							
HIT-V-R	$N_{Rk,s,seis}$ [kN]	26	41	59	110	172	247	230	281
Partial safety factor	$\gamma_{Ms,seis}$ [-]	1,87						2,86	
HIT-V-HCR	$N_{Rk,s,seis}$ [kN]	29	46	67	126	196	247	321	393
Partial safety factor	$\gamma_{Ms,seis}$ [-]	1,5					2,1		
Characteristic bond resistance in cracked concrete C20/25 to C50/60									
Temperature range I: 40°C/24°C	$\tau_{Rk,seis}$ [N/mm ²]	6,4	6,4	6	5,3	5	4,6	4,1	3,6
Temperature range II: 58°C/35°C	$\tau_{Rk,seis}$ [N/mm ²]	5,2	4,8	4,8	4,5	3,9	3,6	3,1	3
Temperature range III: 70°C/43°C	$\tau_{Rk,seis}$ [N/mm ²]	3,2	2,8	2,8	2,6	2,1	2	1,9	1,8
Partial safety factor	$\gamma_{Mp,seis}$ [-]	1,8				2,1			
Concrete cone resistance and splitting resistance									
Partial safety factor	$\gamma_{Mc,seis} = \gamma_{Msp,seis}$ [-]	1,8				2,1			

Displacement under tension load in case of seismic performance category C1 ¹⁾

Anchor size		M8	M10	M12	M16	M20	M24	M27	M30
Displacement ¹⁾	$\delta_{N,seis}$ [mm]	1,5	1,7	1,9	2,3	2,7	3,1	3,4	3,7

1) Maximum displacement during cycling (seismic event).

Shear resistance in case of seismic performance category C1

Anchor size		M8	M10	M12	M16	M20	M24	M27	M30
Characteristic shear resistance to steel failure									
for HIT-V-5.8(F)	$V_{Rk,s,seis}$ [kN]	6	11	15	27	43	62	81	98
for HIT-V-8.8(F)	$V_{Rk,s,seis}$ [kN]	11	16	24	44	69	99	129	157
Partial safety factor	$\gamma_{Ms,seis}$ [-]	1,25							
for HIT-V-R	$V_{Rk,s,seis}$ [kN]	9	14	21	39	60	87	81	98
Partial safety factor	$\gamma_{Ms,seis}$ [-]	1,56						2,38	
for HIT-V-HCR	$V_{Rk,s,seis}$ [kN]	11	16	24	44	69	87	113	137
Partial safety factor	$\gamma_{Ms,seis}$ [-]	1,25					1,75		
Concrete pryout resistance and concrete edge resistance									
Partial safety factor	$\gamma_{Mcp,seis} = \gamma_{Mc,seis}$ [-]	1,5							



Displacement under shear load in case of seismic performance category C1 ¹⁾

Anchor size		M8	M10	M12	M16	M20	M24	M27	M30
Displacement ¹⁾	$\delta_{V,seis}$ [mm]	3,2	3,5	3,8	4,4	5,0	5,6	6,1	6,5

1) Maximum displacement during cycling (seismic event).

For seismic resistant fastening applications please use the anchor design software PROFIS Anchor.

Hilti HIT-RE 500-SD mortar with HIS-(R)N sleeve

Injection mortar system		Benefits
 <p>Hilti HIT-RE 500-SD 330 ml foil pack (also available as 500 ml and 1400 ml foil pack)</p>	 <p>Statik mixer</p>	<ul style="list-style-type: none"> - SAFEset technology: drilling and borehole cleaning in one step with Hilti hollow drill bit - suitable for cracked and non-cracked concrete C 20/25 to C 50/60 - ETA seismic approval C1 - high loading capacity - suitable for dry and water saturated concrete - long working time at elevated temperatures - odourless epoxy
 <p>HIS-(R)N sleeve</p>		



Concrete



Tensile zone



Seismic
ETA-C1



Shock

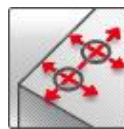

Small edge
distance
and spacing



Fire
resistance

SAFEset

Hilti SAFEset
technology with
hollow drill bit

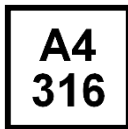

Corrosion
resistance



European
Technical
Approval



CE
conformity



PROFIS
Anchor design
software

Approvals / certificates

Description	Authority / Laboratory	No. / date of issue
European technical approval ^{a)}	DIBt, Berlin	ETA-07/0260 / 2013-06-26
ES report incl. seismic	ICC evaluation service	ESR 2322 / 2014-02-01
Shockproof fastenings in civil defence installations	Federal Office for Civil Protection, Bern	BZS D 08-604 / 2009-10-21
Fire test report	MFPA, Leipzig	GS-III/B-07-070 / 2008-01-18
Assessment report (fire)	warringtonfire	WF 327804/B / 2013-07-10

a) All data given in this section according ETA-07/0260, issue 2013-06-26.

Basic loading data (for a single anchor)

All data in this section applies to

For details see Simplified design method

- Correct setting (See setting instruction)
- No edge distance and spacing influence
- Steel failure
- Screw strength class 8.8
- Base material thickness, as specified in the table
- One typical embedment depth, as specified in the table
- One anchor material, as specified in the tables
- Concrete C 20/25, $f_{ck,cube} = 25 \text{ N/mm}^2$
- Temperature range I
(min. base material temperature -40°C , max. long term/short term base material temperature: $+24^\circ\text{C}/40^\circ\text{C}$)
- Installation temperature range $+5^\circ\text{C}$ to $+40^\circ\text{C}$

Embedment depth and base material thickness for the basic loading data.

Mean ultimate resistance, characteristic resistance, design resistance, recommended loads.

Anchor size	M8	M10	M12	M16	M20
Embedment depth [mm]	90	110	125	170	205
Base material thickness [mm]	120	150	170	230	270

Mean ultimate resistance: concrete C 20/25 – $f_{ck,cube} = 25 \text{ N/mm}^2$, anchor HIS-N

Data according ETA-07/0260, issue 2013-06-26							
Anchor size			M8	M10	M12	M16	M20
Non cracked concrete							
Tensile $N_{Ru,m}$	HIS-N	[kN]	26,3	48,3	70,4	123,9	114,5
Shear $V_{Ru,m}$	HIS-N	[kN]	13,7	24,2	41,0	62,0	57,8
Cracked concrete							
Tensile $N_{Ru,m}$	HIS-N	[kN]	26,3	48,3	67,1	106,4	114,5
Shear $V_{Ru,m}$	HIS-N	[kN]	13,7	24,2	41,0	62,0	57,8

Characteristic resistance: concrete C 20/25 – $f_{ck,cube} = 25 \text{ N/mm}^2$, anchor HIS-N

Data according ETA-07/0260, issue 2013-06-26							
Anchor size			M8	M10	M12	M16	M20
Non cracked concrete							
Tensile N_{Rk}	HIS-N	[kN]	25,0	46,0	67,0	111,9	109,0
Shear V_{Rk}	HIS-N	[kN]	13,0	23,0	39,0	59,0	55,0
Cracked concrete							
Tensile N_{Rk}	HIS-N	[kN]	25,0	40,0	50,3	79,8	105,7
Shear V_{Rk}	HIS-N	[kN]	13,0	23,0	39,0	59,0	55,0

Design resistance: concrete C 20/25 – $f_{ck,cube} = 25 \text{ N/mm}^2$, anchor HIS-N

Data according ETA-07/0260, issue 2013-06-26							
Anchor size			M8	M10	M12	M16	M20
Non cracked concrete							
Tensile N_{Rd}	HIS-N	[kN]	16,8	27,7	33,6	53,3	70,6
Shear V_{Rd}	HIS-N	[kN]	10,4	18,4	26,0	39,3	36,7
Cracked concrete							
Tensile N_{Rd}	HIS-N	[kN]	13,9	19,0	24,0	38,0	50,3
Shear V_{Rd}	HIS-N	[kN]	10,4	18,4	26,0	39,3	36,7

Recommended loads ^{a)}: concrete C 20/25 – $f_{ck,cube} = 25 \text{ N/mm}^2$, anchor HIS-N

			Data according ETA-07/0260, issue 2013-06-26				
Anchor size			M8	M10	M12	M16	M20
Non cracked concrete							
Tensile N_{rec}	HIS-N	[kN]	12,0	19,8	24,0	38,1	50,4
Shear V_{rec}	HIS-N	[kN]	7,4	13,1	18,6	28,1	26,2
Cracked concrete							
Tensile N_{rec}	HIS-N	[kN]	9,9	13,6	17,1	27,1	35,9
Shear V_{rec}	HIS-N	[kN]	7,4	13,1	18,6	28,1	26,2

a) With overall partial safety factor for action $\gamma = 1,4$. The partial safety factors for action depend on the type of loading and shall be taken from national regulations.

Service temperature range

Hilti HIT-RE 500-SD injection mortar may be applied in the temperature ranges given below. An elevated base material temperature may lead to a reduction of the design bond resistance.

Temperature range	Base material temperature	Maximum long term base material temperature	Maximum short term base material temperature
Temperature range I	-40 °C to +40 °C	+24 °C	+40 °C
Temperature range II	-40 °C to +58 °C	+35 °C	+58 °C
Temperature range III	-40 °C to +70 °C	+43 °C	+70 °C

Max short term base material temperature

Short-term elevated base material temperatures are those that occur over brief intervals, e.g. as a result of diurnal cycling.

Max long term base material temperature

Long-term elevated base material temperatures are roughly constant over significant periods of time.

Materials

Mechanical properties of HIS-(R)N

			Data according ETA-07/0260, issue 2013-06-26				
Anchor size			M8	M10	M12	M16	M20
Nominal tensile strength f_{uk}	HIS-N	[N/mm ²]	490	490	460	460	460
	Screw 8.8	[N/mm ²]	800	800	800	800	800
	HIS-RN	[N/mm ²]	700	700	700	700	700
	Screw A4-70	[N/mm ²]	700	700	700	700	700
Yield strength f_{yk}	HIS-N	[N/mm ²]	410	410	375	375	375
	Screw 8.8	[N/mm ²]	640	640	640	640	640
	HIS-RN	[N/mm ²]	350	350	350	350	350
	Screw A4-70	[N/mm ²]	450	450	450	450	450
Stressed cross-section A_s	HIS-(R)N	[mm ²]	51,5	108,0	169,1	256,1	237,6
	Screw	[mm ²]	36,6	58	84,3	157	245
Moment of resistance W	HIS-(R)N	[mm ³]	145	430	840	1595	1543
	Screw	[mm ³]	31,2	62,3	109	277	541

Material quality

Part	Material
internally threaded sleeves ^{a)} HIS-N	C-steel 1.0718, steel galvanized $\geq 5\mu\text{m}$
internally threaded sleeves ^{b)} HIS-RN	stainless steel 1.4401 and 1.4571

a) related fastening screw: strength class 8.8, A5 > 8% Ductile
steel galvanized $\geq 5\mu\text{m}$

b) related fastening screw: strength class 70, A5 > 8% Ductile
stainless steel 1.4401; 1.4404; 1.4578; 1.4571; 1.4439; 1.4362

Anchor dimensions

Anchor size	M8	M10	M12	M16	M20
Internal sleeve HIS-(R)N	M8x90	M10x110	M12x125	M16x170	M20x205
Anchor embedment depth [mm]	90	110	125	170	205

Setting

installation equipment

Anchor size	M8	M10	M12	M16	M20
Rotary hammer	TE 2 – TE 16		TE 40 – TE 70		
Other tools	compressed air gun or blow out pump, set of cleaning brushes, dispenser				

Setting instruction

Bore hole drilling

	<p>Drill hole to the required embedment depth with an appropriately sized Hilti TE-CD or TE-YD hollow drill bit with Hilti vacuum attachment. This drilling system removes the dust and cleans the borehole during drilling when using in accordance with the user's manual.</p> <p>After drilling is complete, proceed to the "injection preparation" step in the instructions for use.</p>
--	--

	<p>Drill Hole to the required embedment depth with a hammer drill set in rotation-hammer mode using an appropriately sized carbide drill bit.</p>
--	---

Bore hole cleaning Just before setting an anchor, the bore hole must be free of dust and debris.

Compressed air cleaning (CAC) for all bore hole diameters d_0 and all bore hole depth h_0

	<p>Blow 2 times from the back of the hole (if needed with nozzle extension) over the hole length with oil-free compressed air (min. 6 bar at 6 m³/h) until return air stream is free of noticeable dust.</p> <p>Bore hole diameter ≥ 32 mm the compressor must supply a minimum air flow of 140 m³/hour.</p>
--	--

	<p>Brush 2 times with the specified brush size by inserting the steel brush Hilti HIT-RB to the back of the hole (if needed with extension) in a twisting motion and removing it.</p> <p>The brush must produce natural resistance as it enters the bore hole -- if not the brush is too small and must be replaced with the proper brush diameter.</p>
--	---

	<p>Blow again with compressed air 2 times until return air stream is free of noticeable dust.</p>
--	---

Injection preparation

	<p>Tightly attach new Hilti mixing nozzle HIT-RE-M to foil pack manifold (snug fit). Do not modify the mixing nozzle.</p> <p>Observe the instruction for use of the dispenser and the mortar. Check foil pack holder for proper function. Do not use damaged foil packs / holders. Insert foil pack into foil pack holder and put holder into HIT-dispenser.</p>
--	--

	<p>The foil pack opens automatically as dispensing is initiated. Discard initial adhesive. Depending on the size of the foil pack an initial amount of adhesive has to be discarded.</p> <p>Discard quantities are:</p> <ul style="list-style-type: none"> 3 strokes for 330 ml foil pack, 4 strokes for 500 ml foil pack, 65 ml for 1400 ml foil pack $\leq 5^\circ\text{C}$.
--	--

Inject adhesive from the back of the borehole without forming air voids

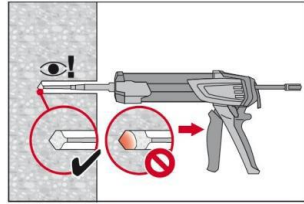

Inject the adhesive starting at the back of the hole, slowly withdrawing the mixer with each trigger pull. Fill holes approximately 2/3 full. It is required that the annular gap between the anchor and the concrete is completely filled with adhesive along the embedment length.

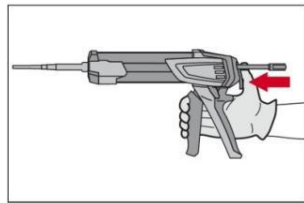

After injection is completed, depressurize the dispenser by pressing the release trigger. This will prevent further adhesive discharge from the mixer.

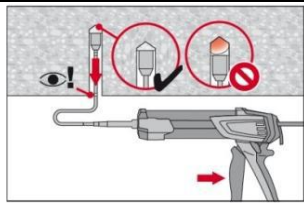

Overhead installation and/or installation with embedment depth $h_{ef} > 250\text{mm}$. For overhead installation the injection is only possible with the aid of extensions and piston plugs. Assemble HIT-RE-M mixer, extension(s) and appropriately sized piston plug (HIT-SZ). Insert piston plug to back of the hole and inject adhesive. During injection the piston plug will be naturally extruded out of the bore hole by the adhesive pressure.

Setting the element

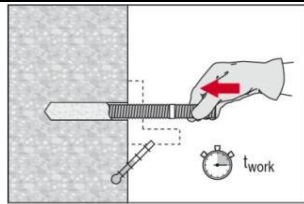

Before use, verify that the element is dry and free of oil and other contaminants. Mark and set element to the required embedment depth until working time t_{work} has elapsed.

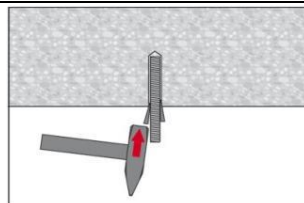

For overhead installation use piston plugs and fix embedded parts with e.g. wedges HIT-OHW.

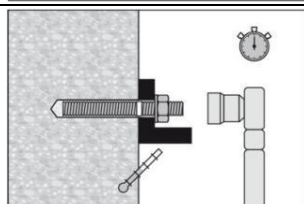

Loading the anchor:
After required curing time t_{cure} the anchor can be loaded. The applied installation torque shall not exceed given T_{max} .

For detailed information on installation see instruction for use given with the package of the product.

Curing time for general conditions

Data according ETA-07/0260, issue 2013-06-26		
Temperature of the base material	Working time in which anchor can be inserted and adjusted t_{gel}	Curing time before anchor can be fully loaded t_{cure}
40 °C	12 min	4 h
30 °C to 39 °C	12 min	8 h
20 °C to 29 °C	20 min	12 h
15 °C to 19 °C	30 min	24 h
10 °C to 14 °C	90 min	48 h
5 °C to 9 °C	120 min	72 h

Setting details

		Data according ETA-07/0260, issue 2013-06-26				
Anchor size		M8	M10	M12	M16	M20
Nominal diameter of drill bit	d_0 [mm]	14	18	22	28	32
Diameter of element	d [mm]	12,5	16,5	20,5	25,4	27,6
Effective anchorage and drill hole depth	h_{ef} [mm]	90	110	125	170	205
Minimum base material thickness	h_{min} [mm]	120	150	170	230	270
Diameter of clearance hole in the fixture	d_f [mm]	9	12	14	18	22
Thread engagement length; min - max	h_s [mm]	8-20	10-25	12-30	16-40	20-50
Minimum spacing	s_{min} [mm]	40	45	55	65	90
Minimum edge distance	c_{min} [mm]	40	45	55	65	90
Critical spacing for splitting failure	$s_{cr,sp}$	$2 c_{cr,sp}$				
Critical edge distance for splitting failure ^{a)}	$c_{cr,sp}$ [mm]	$1,0 \cdot h_{ef}$ for $h / h_{ef} \geq 2,0$				
		$4,6 h_{ef} - 1,8 h$ for $2,0 > h / h_{ef} > 1,3$				
		$2,26 h_{ef}$ for $h / h_{ef} \leq 1,3$				
Critical spacing for concrete cone failure	$s_{cr,N}$	$2 c_{cr,N}$				
Critical edge distance for concrete cone failure ^{b)}	$c_{cr,N}$	$1,5 h_{ef}$				
Torque moment ^{c)}	T_{max} [Nm]	10	20	40	80	150

For spacing (edge distance) smaller than critical spacing (critical edge distance) the design loads have to be reduced.

- a) h : base material thickness ($h \geq h_{min}$)
- b) The critical edge distance for concrete cone failure depends on the embedment depth h_{ef} and the design bond resistance. The simplified formula given in this table is on the safe side.
- c) This is the maximum recommended torque moment to avoid splitting failure during installation for anchors with minimum spacing and/or edge distance.

Simplified design method

Simplified version of the design method according ETAG 001, TR 029. Design resistance according data given in ETA-07/0260, issue 2013-06-26.

- Influence of concrete strength
- Influence of edge distance
- Influence of spacing
- Valid for a group of two anchors. (The method may also be applied for anchor groups with more than two anchors or more than one edge distance. The influencing factors must then be considered for each edge distance and spacing. The calculated design loads are then on the save side: They will be lower than the exact values according ETAG 001, TR 029. To avoid this, it is recommended to use the anchor design software PROFIS anchor)

The design method is based on the following simplification:

- No different loads are acting on individual anchors (no eccentricity)

The values are valid for one anchor.

For more complex fastening applications please use the anchor design software PROFIS Anchor.

Tension loading

The design tensile resistance is the lower value of

- Steel resistance: $N_{Rd,s}$
- Combined pull-out and concrete cone resistance: $N_{Rd,p} = N_{Rd,p}^0 \cdot f_{B,p} \cdot f_{1,N} \cdot f_{2,N} \cdot f_{3,N} \cdot f_{h,p} \cdot f_{re,N}$
- Concrete cone resistance: $N_{Rd,c} = N_{Rd,c}^0 \cdot f_B \cdot f_{1,N} \cdot f_{2,N} \cdot f_{3,N} \cdot f_{h,N} \cdot f_{re,N}$
- Concrete splitting resistance (only non-cracked concrete): $N_{Rd,sp} = N_{Rd,c}^0 \cdot f_B \cdot f_{1,sp} \cdot f_{2,sp} \cdot f_{3,sp} \cdot f_{h,N} \cdot f_{re,N}$

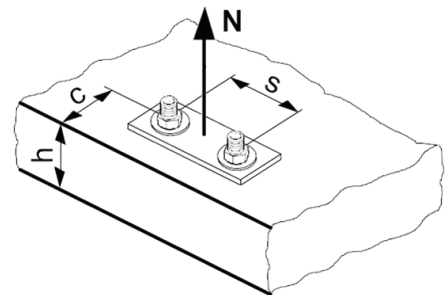

Basic design tensile resistance

Design steel resistance $N_{Rd,s}$

		Data according ETA-07/0260, issue 2013-06-26				
Anchor size		M8	M10	M12	M16	M20
$N_{Rd,s}$	HIS-N [kN]	17,4	30,7	44,7	80,3	74,1
	HIS-RN [kN]	13,9	21,9	31,6	58,8	69,2

Design combined pull-out and concrete cone resistance

$$N_{Rd,p} = N_{Rd,p}^0 \cdot f_{B,p} \cdot f_{1,N} \cdot f_{2,N} \cdot f_{3,N} \cdot f_{h,p} \cdot f_{re,N}$$

Data according ETA-07/0260, issue 2013-06-26					
Anchor size	M8	M10	M12	M16	M20
Embedment depth h_{ef} [mm]	90	110	125	170	205
Non cracked concrete					
$N_{Rd,p}^0$ Temperature range I [kN]	22,2	28,6	45,2	81,0	95,2
$N_{Rd,p}^0$ Temperature range II [kN]	19,4	23,8	35,7	66,7	81,0
$N_{Rd,p}^0$ Temperature range III [kN]	11,1	14,3	19,0	35,7	45,2
Cracked concrete					
$N_{Rd,p}^0$ Temperature range I [kN]	13,9	19,0	28,6	45,2	54,8
$N_{Rd,p}^0$ Temperature range II [kN]	11,1	16,7	19,0	35,7	45,2
$N_{Rd,p}^0$ Temperature range III [kN]	6,7	9,5	11,9	19,0	23,8

$$\text{Design concrete cone resistance } N_{Rd,c} = N_{Rd,c}^0 \cdot f_B \cdot f_{1,N} \cdot f_{2,N} \cdot f_{3,N} \cdot f_{h,N} \cdot f_{re,N}$$

$$\text{Design splitting resistance } N_{Rd,sp} = N_{Rd,c}^0 \cdot f_B \cdot f_{1,sp} \cdot f_{2,sp} \cdot f_{3,sp} \cdot f_{h,N} \cdot f_{re,N}$$

Data according ETA-07/0260, issue 2013-06-26					
Anchor size	M8	M10	M12	M16	M20
$N_{Rd,c}^0$ Non cracked concrete [kN]	24,0	27,7	33,6	53,3	70,6
$N_{Rd,c}^0$ Cracked concrete [kN]	17,1	19,8	24,0	38,0	50,3

a) Splitting resistance must only be considered for non-cracked concrete

Influencing factors

Influence of concrete strength on combined pull-out and concrete cone resistance

Concrete strength designation (ENV 206)	C 20/25	C 25/30	C 30/37	C 35/45	C 40/50	C 45/55	C 50/60
$f_{B,p} = (f_{ck,cube}/25N/mm^2)^{0,1}$ a)	1	1,02	1,04	1,06	1,07	1,08	1,09

a) $f_{ck,cube}$ = concrete compressive strength, measured on cubes with 150 mm side length

Influence of embedment depth on combined pull-out and concrete cone resistance

$f_{h,p} = 1$

Influence of concrete strength on concrete cone resistance

Concrete strength designation (ENV 206)	C 20/25	C 25/30	C 30/37	C 35/45	C 40/50	C 45/55	C 50/60
$f_B = (f_{ck,cube}/25N/mm^2)^{1/2}$ a)	1	1,1	1,22	1,34	1,41	1,48	1,55

a) $f_{ck,cube}$ = concrete compressive strength, measured on cubes with 150 mm side length

Influence of edge distance ^{a)}

$c/c_{cr,N}$	0,1	0,2	0,3	0,4	0,5	0,6	0,7	0,8	0,9	1
$c/c_{cr,sp}$										
$f_{1,N} = 0,7 + 0,3 \cdot c/c_{cr,N}$	0,73	0,76	0,79	0,82	0,85	0,88	0,91	0,94	0,97	1
$f_{1,sp} = 0,7 + 0,3 \cdot c/c_{cr,sp}$										
$f_{2,N} = 0,5 \cdot (1 + c/c_{cr,N})$	0,55	0,60	0,65	0,70	0,75	0,80	0,85	0,90	0,95	1
$f_{2,sp} = 0,5 \cdot (1 + c/c_{cr,sp})$										

a) The edge distance shall not be smaller than the minimum edge distance c_{min} given in the table with the setting details. These influencing factors must be considered for every edge distance smaller than the critical edge distance.

Influence of anchor spacing ^{a)}

$s/s_{cr,N}$	0,1	0,2	0,3	0,4	0,5	0,6	0,7	0,8	0,9	1
$s/s_{cr,sp}$										
$f_{3,N} = 0,5 \cdot (1 + s/s_{cr,N})$	0,55	0,60	0,65	0,70	0,75	0,80	0,85	0,90	0,95	1
$f_{3,sp} = 0,5 \cdot (1 + s/s_{cr,sp})$										

a) The anchor spacing shall not be smaller than the minimum anchor spacing s_{min} given in the table with the setting details. This influencing factor must be considered for every anchor spacing.

Influence of embedment depth on concrete cone resistance

$f_{h,N} = 1$

Influence of reinforcement

h_{ef} [mm]	80	90	≥ 100
$f_{re,N} = 0,5 + h_{ef}/200mm \leq 1$	0,9 ^{a)}	0,95 ^{a)}	1

a) This factor applies only for dense reinforcement. If in the area of anchorage there is reinforcement with a spacing ≥ 150 mm (any diameter) or with a diameter ≤ 10 mm and a spacing ≥ 100 mm, then a factor $f_{re} = 1$ may be applied.

Shear loading

The design shear resistance is the lower value of

- Steel resistance: $V_{Rd,s}$
- Concrete pryout resistance: $V_{Rd,cp} = k \cdot \text{lower value of } N_{Rd,p} \text{ and } N_{Rd,c}$
- Concrete edge resistance: $V_{Rd,c} = V_{Rd,c}^0 \cdot f_B \cdot f_h \cdot f_4 \cdot f_{hef} \cdot f_c$

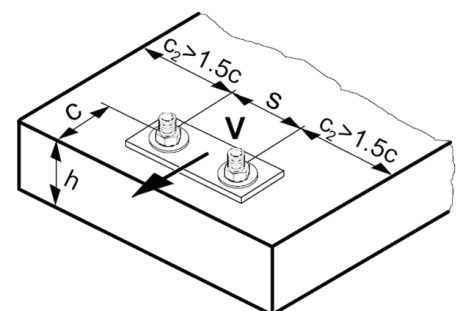

Basic design shear resistance

Design steel resistance $V_{Rd,s}$

		Data according ETA-07/0260, issue 2013-06-26				
Anchor size		M8	M10	M12	M16	M20
$V_{Rd,s}$	HIS-N [kN]	10,4	18,4	26,0	39,3	36,7
	HIS-RN [kN]	8,3	12,8	19,2	35,3	41,5

Design concrete pryout resistance $V_{Rd,cp} = \text{lower value}^a)$ of $k \cdot N_{Rd,p}$ and $k \cdot N_{Rd,c}$

$$k = 1 \text{ for } h_{ef} < 60 \text{ mm}$$

$$k = 2 \text{ for } h_{ef} \geq 60 \text{ mm}$$

- a) $N_{Rd,p}$: Design combined pull-out and concrete cone resistance
 $N_{Rd,c}$: Design concrete cone resistance

Design concrete edge resistance $V_{Rd,c} = V_{Rd,c}^0 \cdot f_B \cdot f_{\beta} \cdot f_h \cdot f_4 \cdot f_{hef} \cdot f_c$

Anchor size		M8	M10	M12	M16	M20
Non-cracked concrete						
$V_{Rd,c}^0$	[kN]	12,4	19,6	28,2	40,2	46,2
Cracked concrete						
$V_{Rd,c}^0$	[kN]	8,8	13,9	20,0	28,5	32,7

Influencing factors

Influence of concrete strength

Concrete strength designation (ENV 206)	C 20/25	C 25/30	C 30/37	C 35/45	C 40/50	C 45/55	C 50/60
$f_B = (f_{ck,cube}/25N/mm^2)^{1/2}$ a)	1	1,1	1,22	1,34	1,41	1,48	1,55

- a) $f_{ck,cube}$ = concrete compressive strength, measured on cubes with 150 mm side length

Influence of angle between load applied and the direction perpendicular to the free edge

Angle β	0°	10°	20°	30°	40°	50°	60°	70°	80°	≥ 90°
$f_{\beta} = \sqrt{\frac{1}{(\cos \alpha_v)^2 + \left(\frac{\sin \alpha_v}{2,5}\right)^2}}$	1	1,01	1,05	1,13	1,24	1,40	1,64	1,97	2,32	2,50

Influence of base material thickness

h/c	0,15	0,3	0,45	0,6	0,75	0,9	1,05	1,2	1,35	≥ 1,5
$f_h = \{h/(1,5 \cdot c)\}^{1/2} \leq 1$	0,32	0,45	0,55	0,63	0,71	0,77	0,84	0,89	0,95	1,00

Influence of anchor spacing and edge distance ^{a)} for concrete edge resistance: f_4
 $f_4 = (c/h_{ef})^{1,5} \cdot (1 + s / [3 \cdot c]) \cdot 0,5$

c/h _{ef}	Single anchor	Group of two anchors s/h _{ef}														
		0,75	1,50	2,25	3,00	3,75	4,50	5,25	6,00	6,75	7,50	8,25	9,00	9,75	10,50	11,25
0,50	0,35	0,27	0,35	0,35	0,35	0,35	0,35	0,35	0,35	0,35	0,35	0,35	0,35	0,35	0,35	0,35
0,75	0,65	0,43	0,54	0,65	0,65	0,65	0,65	0,65	0,65	0,65	0,65	0,65	0,65	0,65	0,65	0,65
1,00	1,00	0,63	0,75	0,88	1,00	1,00	1,00	1,00	1,00	1,00	1,00	1,00	1,00	1,00	1,00	1,00
1,25	1,40	0,84	0,98	1,12	1,26	1,40	1,40	1,40	1,40	1,40	1,40	1,40	1,40	1,40	1,40	1,40
1,50	1,84	1,07	1,22	1,38	1,53	1,68	1,84	1,84	1,84	1,84	1,84	1,84	1,84	1,84	1,84	1,84
1,75	2,32	1,32	1,49	1,65	1,82	1,98	2,15	2,32	2,32	2,32	2,32	2,32	2,32	2,32	2,32	2,32
2,00	2,83	1,59	1,77	1,94	2,12	2,30	2,47	2,65	2,83	2,83	2,83	2,83	2,83	2,83	2,83	2,83
2,25	3,38	1,88	2,06	2,25	2,44	2,63	2,81	3,00	3,19	3,38	3,38	3,38	3,38	3,38	3,38	3,38
2,50	3,95	2,17	2,37	2,57	2,77	2,96	3,16	3,36	3,56	3,76	3,95	3,95	3,95	3,95	3,95	3,95
2,75	4,56	2,49	2,69	2,90	3,11	3,32	3,52	3,73	3,94	4,15	4,35	4,56	4,56	4,56	4,56	4,56
3,00	5,20	2,81	3,03	3,25	3,46	3,68	3,90	4,11	4,33	4,55	4,76	4,98	5,20	5,20	5,20	5,20
3,25	5,86	3,15	3,38	3,61	3,83	4,06	4,28	4,51	4,73	4,96	5,18	5,41	5,63	5,86	5,86	5,86
3,50	6,55	3,51	3,74	3,98	4,21	4,44	4,68	4,91	5,14	5,38	5,61	5,85	6,08	6,31	6,55	6,55
3,75	7,26	3,87	4,12	4,36	4,60	4,84	5,08	5,33	5,57	5,81	6,05	6,29	6,54	6,78	7,02	7,26
4,00	8,00	4,25	4,50	4,75	5,00	5,25	5,50	5,75	6,00	6,25	6,50	6,75	7,00	7,25	7,50	7,75
4,25	8,76	4,64	4,90	5,15	5,41	5,67	5,93	6,18	6,44	6,70	6,96	7,22	7,47	7,73	7,99	8,25
4,50	9,55	5,04	5,30	5,57	5,83	6,10	6,36	6,63	6,89	7,16	7,42	7,69	7,95	8,22	8,49	8,75
4,75	10,35	5,45	5,72	5,99	6,27	6,54	6,81	7,08	7,36	7,63	7,90	8,17	8,45	8,72	8,99	9,26
5,00	11,18	5,87	6,15	6,43	6,71	6,99	7,27	7,55	7,83	8,11	8,39	8,66	8,94	9,22	9,50	9,78
5,25	12,03	6,30	6,59	6,87	7,16	7,45	7,73	8,02	8,31	8,59	8,88	9,17	9,45	9,74	10,02	10,31
5,50	12,90	6,74	7,04	7,33	7,62	7,92	8,21	8,50	8,79	9,09	9,38	9,67	9,97	10,26	10,55	10,85

a) The anchor spacing and the edge distance shall not be smaller than the minimum anchor spacing s_{min} and the minimum edge distance c_{min} .

Influence of embedment depth

Anchor size	M8	M10	M12	M16	M20
$f_{hef} =$	1,38	1,21	1,04	1,22	1,45

Influence of edge distance ^{a)}

c/d	4	6	8	10	15	20	30	40
$f_c = (d / c)^{0,19}$	0,77	0,71	0,67	0,65	0,60	0,57	0,52	0,50

a) The edge distance shall not be smaller than the minimum edge distance c_{min} .

Combined tension and shear loading

For combined tension and shear loading see section "Anchor Design".

Precalculated values

Recommended loads can be calculated by dividing the design resistance by an overall partial safety factor for action $\gamma = 1,4$. The partial safety factors for action depend on the type of loading and shall be taken from national regulations.

Design resistance: concrete C 20/25 – $f_{ck,cube} = 25 \text{ N/mm}^2$, Temperature range I

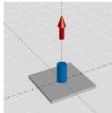
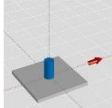
		Data according ETA-07/0260, issue 2013-06-26				
Anchor size		M8	M10	M12	M16	M20
Embedment depth h_{ef} [mm]		90	110	125	170	205
Base material thickness h_{min} [mm]		120	150	170	230	270
Tensile N_{Rd}: single anchor, no edge effects						
Non cracked concrete						
 HIS-N [kN]		17,4	27,7	33,6	53,3	70,6
HIS-RN [kN]		13,9	21,9	31,6	53,3	69,2
Cracked concrete						
HIS-(R)N [kN]		13,9	19,0	24,0	38,0	50,3
Shear V_{Rd}: single anchor, no edge effects, without lever arm						
Non cracked and cracked concrete						
 HIS-N [kN]		10,4	18,4	26,0	39,3	36,7
HIS-RN [kN]		8,3	12,8	19,2	35,3	41,5

Design resistance: concrete C 20/25 – $f_{ck,cube} = 25 \text{ N/mm}^2$, Temperature range I

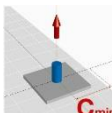
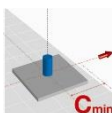
		Data according ETA-07/0260, issue 2013-06-26				
Anchor size		M8	M10	M12	M16	M20
Embedment depth h_{ef} [mm]		90	110	125	170	205
Base material thickness h_{min} [mm]		120	150	170	230	270
Edge distance $c = c_{min}$ [mm]		40	45	55	65	90
Tensile N_{Rd}: single anchor, min. edge distance ($c = c_{min}$)						
Non cracked concrete						
 HIS-(R)N [kN]		11,0	12,4	15,4	23,5	32,0
Cracked concrete						
HIS-(R)N [kN]		7,1	8,9	11,0	16,8	22,8
Shear V_{Rd}: single anchor, min. edge distance ($c = c_{min}$), without lever arm						
Non cracked concrete						
 HIS-(R)N [kN]		4,2	5,5	7,6	10,8	17,2
Cracked concrete						
HIS-(R)N [kN]		3,0	3,9	5,4	7,7	12,2

Design resistance: concrete C 20/25 – $f_{ck,cube} = 25 \text{ N/mm}^2$, Temperature range I
(load values are valid for single anchor)

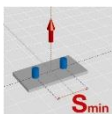
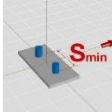
		Data according ETA-07/0260, issue 2013-06-26				
Anchor size		M8	M10	M12	M16	M20
Embedment depth h_{ef} [mm]		90	110	125	170	205
Base material thickness h_{min} [mm]		120	150	170	230	270
Spacing $s = s_{min}$ [mm]		40	45	55	65	90
Tensile N_{Rd}: double anchor, no edge effects, min. spacing ($s = s_{min}$)						
Non cracked concrete						
 HIS-(R)N [kN]		13,1	15,2	18,5	29,0	38,8
Cracked concrete						
HIS-(R)N [kN]		8,5	10,8	13,2	20,6	27,6
Shear V_{Rd}: double anchor, no edge effects, min. spacing ($s = s_{min}$), without lever arm						
Non cracked and cracked concrete						
 HIS-N [kN]		10,4	18,4	26,0	39,3	36,7
HIS-RN [kN]		8,3	12,8	19,2	35,3	41,5

Seismic design C1

Basic loading data for concrete C20/25 – C50/60

All data in this section applies to:

- Seismic design according to TR045

The following technical data are based on: ETA-07/0260, issue 2013-06-26

Anchorage depth range

Anchor size	M8	M10	M12	M16	M20
Effective anchorage depth h_{ef} [mm]	90	110	125	170	205

Tension resistance in case of seismic performance category C1

Anchor size	M8	M10	M12	M16	M20	
Diameter of element	12,5	16,5	20,5	25,4	27,6	
Characteristic tension resistance to steel failure						
HIS-N steel grade 8.8	$N_{Rk,s,seis}$ [kN]	25	46	67	118	109
Partial safety factor	$\gamma_{Ms,seis}$ [-]	1,43	1,5		1,47	
HIS-RN steel grade 70	$N_{Rk,s,seis}$ [kN]	26	41	59	110	166
Partial safety factor	$\gamma_{Ms,seis}$ [-]	1,87				2,4
Characteristic bond resistance in cracked concrete C20/25 to C50/60						
Temperature range I: 40°C/24°C	$N_{Rk,p,seis}$ [N/mm ²]	20	30	42	61	71
Temperature range II: 58°C/35°C	$N_{Rk,p,seis}$ [N/mm ²]	16	26	28	48	59
Temperature range III: 70°C/43°C	$N_{Rk,p,seis}$ [N/mm ²]	9,5	15	17	25	31
Partial safety factor	$\gamma_{Mp,seis}$ [-]	1,8	2,1			
Concrete cone resistance and splitting resistance						
Partial safety factor	$\gamma_{Mc,seis} = \gamma_{Msp,seis}$ [-]	1,8	2,1			

Displacement under tension load in case of seismic performance category C1 ¹⁾

Anchor size	M8	M10	M12	M16	M20	
Displacement ¹⁾	$\delta_{N,seis}$ [mm]	1,5	1,7	1,9	2,3	2,7

1) Maximum displacement during cycling (seismic event).

Shear resistance in case of seismic performance category C1

Anchor size	M8	M10	M12	M16	M20	
Characteristic shear resistance to steel failure						
HIS-N steel grade 8.8	$N_{Rk,s,seis}$ [kN]	9	16	27	41	39
Partial safety factor	$\gamma_{Ms,seis}$ [-]	1,25		1,5		
HIS-RN steel grade 70	$N_{Rk,s,seis}$ [kN]	9	14	21	39	58
Partial safety factor	$\gamma_{Ms,seis}$ [-]	1,56				2,0
Concrete pryout resistance and concrete edge resistance						
Partial safety factor	$\gamma_{Mcp,seis} = \gamma_{Mc,seis}$ [-]	1,5				

Displacement under shear load in case of seismic performance category C1 ¹⁾

Anchor size	M8	M10	M12	M16	M20	
Displacement ¹⁾	$\delta_{V,seis}$ [mm]	3,2	3,5	3,8	4,4	5,0

1) Maximum displacement during cycling (seismic event).

For seismic resistant fastening applications please use the anchor design software PROFIS Anchor.

Hilti HIT-RE 500-SD mortar with rebar (as anchor)

Injection mortar system	Benefits
 <p>Hilti HIT-RE 500-SD 330 ml foil pack (also available as 500 ml and 1400 ml foil pack)</p> <p>Statik mixer</p> <p>rebar BSt 500 S</p>	<ul style="list-style-type: none"> - SAFEset technology: drilling and borehole cleaning in one step with Hilti hollow drill bit - suitable for non-cracked and cracked concrete C 20/25 to C 50/60 - ETA seismic approval C1 - high loading capacity - suitable for dry and water saturated concrete - large diameter applications - high corrosion resistant - long working time at elevated temperatures - odourless epoxy - embedment depth range: from 60 ... 160 mm for Ø8 to 128 ... 640 mm for Ø32



Concrete



Tensile zone



Seismic
ETA-C1

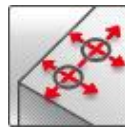

Small edge
distance
and spacing

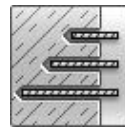

Variable
embedment
depth



Fire
resistance

SAFEset

Hilti SAFEset
technology with
hollow drill bit



European
Technical
Approval



CE
conformity



PROFIS
Anchor design
software

Approvals / certificates

Description	Authority / Laboratory	No. / date of issue
European technical approval ^{a)}	DIBt, Berlin	ETA-07/0260 / 2013-06-26
ES report incl. seismic	ICC evaluation service	ESR 2322 / 2014-02-01
Fire test report	MFPA, Leipzig	GS-III/B-07-070 / 2008-01-18
Assessment report (fire)	warringtonfire	WF 327804/B / 2013-07-10

a) All data given in this section according ETA-07/0260, issue 2013-06-26.

Basic loading data (for a single anchor)

All data in this section applies to

For details see Simplified design method

- Correct setting (See setting instruction)
- No edge distance and spacing influence
- Steel failure
- Base material thickness, as specified in the table
- One typical embedment depth, as specified in the table
- One anchor material, as specified in the tables
- Concrete C 20/25, $f_{ck,cube} = 25 \text{ N/mm}^2$
- Temperature range I
(min. base material temperature -40°C , max. long term/short term base material temperature: $+24^\circ\text{C}/40^\circ\text{C}$)
- Installation temperature range $+5^\circ\text{C}$ to $+40^\circ\text{C}$

Embedment depth ^{a)} and base material thickness for the basic loading data.

Mean ultimate resistance, characteristic resistance, design resistance, recommended loads.

	Data according ETA-07/0260, issue 2013-06-26								
Anchor size	Ø8	Ø10	Ø12	Ø14	Ø16	Ø20	Ø25	Ø28	Ø32
Typical embedment depth [mm]	80	90	110	125	125	170	210	270	300
Base material thickness [mm]	110	120	145	165	165	220	275	340	380

a) The allowed range of embedment depth is shown in the setting details. The corresponding load values can be calculated according to the simplified design method.

Mean ultimate resistance: concrete C 20/25 – $f_{ck,cube} = 25 \text{ N/mm}^2$, anchor rebar BSt 500S

	Data according ETA-07/0260, issue 2013-06-26								
Anchor size	Ø8	Ø10	Ø12	Ø14	Ø16	Ø20	Ø25	Ø28	Ø32
Non cracked concrete									
Tensile $N_{R_{u,m}}$ BSt 500 S [kN]	29,4	45,2	65,1	89,3	94,1	149,2	204,9	298,7	349,9
Shear $V_{R_{u,m}}$ BSt 500 S [kN]	14,7	23,1	32,6	44,1	57,8	90,3	141,8	177,5	232,1
Cracked concrete									
Tensile $N_{R_{u,m}}$ BSt 500 S [kN]	23,8	33,5	46,1	57,0	65,2	110,8	146,1	228,7	268,1
Shear $V_{R_{u,m}}$ BSt 500 S [kN]	14,7	23,1	32,6	44,1	57,8	90,3	141,8	177,5	232,1

Characteristic resistance: concrete C 20/25 – $f_{ck,cube} = 25 \text{ N/mm}^2$, anchor rebar BSt 500 S

	Data according ETA-07/0260, issue 2013-06-26								
Anchor size	Ø8	Ø10	Ø12	Ø14	Ø16	Ø20	Ø25	Ø28	Ø32
Non cracked concrete									
Tensile N_{R_k} BSt 500 S [kN]	28,0	42,4	58,3	70,6	70,6	111,9	153,7	224,0	262,4
Shear V_{R_k} BSt 500 S [kN]	14,0	22,0	31,0	42,0	55,0	86,0	135,0	169,0	221,0
Cracked concrete									
Tensile N_{R_k} BSt 500 S [kN]	16,1	22,6	31,1	38,5	44,0	74,8	109,6	154,4	181,0
Shear V_{R_k} BSt 500 S [kN]	14,0	22,0	31,0	42,0	55,0	86,0	135,0	169,0	221,0

Design resistance: concrete C 20/25 – $f_{ck,cube} = 25 \text{ N/mm}^2$, anchor rebar BSt 500 S

	Data according ETA-07/0260, issue 2013-06-26								
Anchor size	Ø8	Ø10	Ø12	Ø14	Ø16	Ø20	Ø25	Ø28	Ø32
Non cracked concrete									
Tensile N_{R_d} BSt 500 S [kN]	16,8	23,6	32,4	39,2	33,6	53,3	73,2	106,7	125,0
Shear V_{R_d} BSt 500 S [kN]	9,3	14,7	20,7	28,0	36,7	57,3	90,0	112,7	147,3
Cracked concrete									
Tensile N_{R_d} BSt 500 S [kN]	8,9	12,6	17,3	21,4	20,9	35,6	52,2	73,5	86,2
Shear V_{R_d} BSt 500 S [kN]	9,3	14,7	20,7	28,0	36,7	57,3	90,0	112,7	147,3

Recommended loads ^{a)}: concrete C 20/25 – $f_{ck,cube} = 25 \text{ N/mm}^2$, anchor rebar BSt 500 S

		Data according ETA-07/0260, issue 2013-06-26								
Anchor size		Ø8	Ø10	Ø12	Ø14	Ø16	Ø20	Ø25	Ø28	Ø32
Non cracked concrete										
Tensile N_{rec}	BSt 500 S [kN]	12,0	16,8	23,1	28,0	24,0	38,1	52,3	76,2	89,3
Shear V_{rec}	BSt 500 S [kN]	6,7	10,5	14,8	20,0	26,2	41,0	64,3	80,5	105,2
Cracked concrete										
Tensile N_{rec}	BSt 500 S [kN]	6,4	9,0	12,3	15,3	15,0	25,4	37,3	52,5	61,5
Shear V_{rec}	BSt 500 S [kN]	6,7	10,5	14,8	20,0	26,2	41,0	64,3	80,5	105,2

a) With overall partial safety factor for action $\gamma = 1,4$. The partial safety factors for action depend on the type of loading and shall be taken from national regulations.

Service temperature range

Hilti HIT-RE 500-SD injection mortar may be applied in the temperature ranges given below. An elevated base material temperature may lead to a reduction of the design bond resistance.

Temperature range	Base material temperature	Maximum long term base material temperature	Maximum short term base material temperature
Temperature range I	-40 °C to +40 °C	+24 °C	+40 °C
Temperature range II	-40 °C to +58 °C	+35 °C	+58 °C
Temperature range III	-40 °C to +70 °C	+43 °C	+70 °C

Max short term base material temperature

Short-term elevated base material temperatures are those that occur over brief intervals, e.g. as a result of diurnal cycling.

Max long term base material temperature

Long-term elevated base material temperatures are roughly constant over significant periods of time.

Materials

Mechanical properties of rebar BSt 500S

		Data according ETA-07/0260, issue 2013-06-26								
Anchor size		Ø8	Ø10	Ø12	Ø14	Ø16	Ø20	Ø25	Ø28	Ø32
Nominal tensile strength f_{uk}	BSt 500 S [N/mm ²]	550	550	550	550	550	550	550	550	550
Yield strength f_{yk}	BSt 500 S [N/mm ²]	500	500	500	500	500	500	500	500	500
Stressed cross-section A_s	BSt 500 S [mm ²]	50,3	78,5	113,1	153,9	201,1	314,2	490,9	615,8	804,2
Moment of resistance W	BSt 500 S [mm ³]	50,3	98,2	169,6	269,4	402,1	785,4	1534	2155	3217

Material quality

Part	Material
rebar BSt 500 S	Geometry and mechanical properties according to DIN 488-2:1986 or E DIN 488-2:2006

Setting

installation equipment

Anchor size	Ø8	Ø10	Ø12	Ø14	Ø16	Ø20	Ø25	Ø28	Ø32
Rotary hammer	TE 2 – TE 16					TE 40 – TE 70			
Other tools	compressed air gun or blow out pump, set of cleaning brushes, dispenser								

Setting instruction

Bore hole drilling

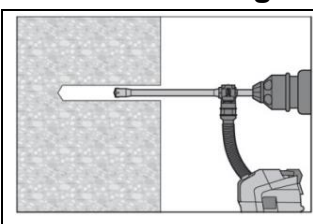
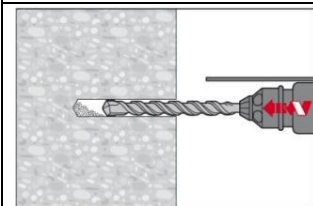
	<p>Drill hole to the required embedment depth with an appropriately sized Hilti TE-CD or TE-YD hollow drill bit with Hilti vacuum attachment. This drilling system removes the dust and cleans the borehole during drilling when using in accordance with the user's manual.</p> <p>After drilling is complete, proceed to the "injection preparation" step in the instructions for use.</p>
	<p>Drill Hole to the required embedment depth with a hammer drill set in rotation-hammer mode using an appropriately sized carbide drill bit.</p>

Bore hole cleaning Just before setting an anchor, the bore hole must be free of dust and debris.

Compressed air cleaning (CAC) for all bore hole diameters d_0 and all bore hole depth h_0

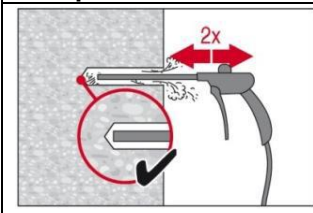
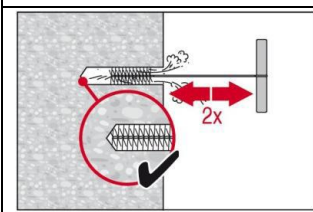
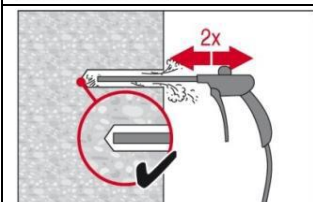
	<p>Blow 2 times from the back of the hole (if needed with nozzle extension) over the hole length with oil-free compressed air (min. 6 bar at 6 m³/h) until return air stream is free of noticeable dust.</p> <p>Bore hole diameter ≥ 32 mm the compressor must supply a minimum air flow of 140 m³/hour.</p>
	<p>Brush 2 times with the specified brush size by inserting the steel brush Hilti HIT-RB to the back of the hole (if needed with extension) in a twisting motion and removing it.</p> <p>The brush must produce natural resistance as it enters the bore hole -- if not the brush is too small and must be replaced with the proper brush diameter.</p>
	<p>Blow again with compressed air 2 times until return air stream is free of noticeable dust.</p>

Injection preparation

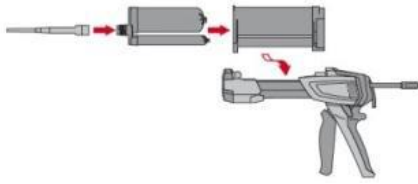

Tightly attach new Hilti mixing nozzle HIT-RE-M to foil pack manifold (snug fit). Do not modify the mixing nozzle.
Observe the instruction for use of the dispenser and the mortar. Check foil pack holder for proper function. Do not use damaged foil packs / holders. Insert foil pack into foil pack holder and put holder into HIT-dispenser.

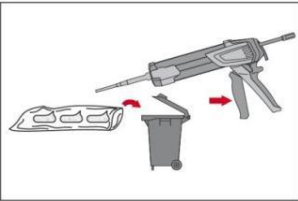

The foil pack opens automatically as dispensing is initiated. Discard initial adhesive. Depending on the size of the foil pack an initial amount of adhesive has to be discarded.

Discard quantities are:

- 3 strokes for 330 ml foil pack,
- 4 strokes for 500 ml foil pack,
- 65 ml for 1400 ml foil pack $\leq 5^{\circ}\text{C}$.

Inject adhesive from the back of the borehole without forming air voids

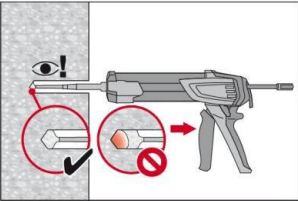

Inject the adhesive starting at the back of the hole, slowly withdrawing the mixer with each trigger pull.
Fill holes approximately 2/3 full. It is required that the annular gap between the anchor and the concrete is completely filled with adhesive along the embedment length.

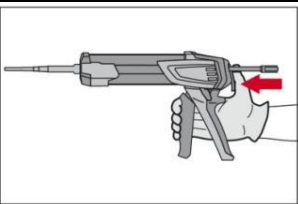

After injection is completed, depressurize the dispenser by pressing the release trigger. This will prevent further adhesive discharge from the mixer.

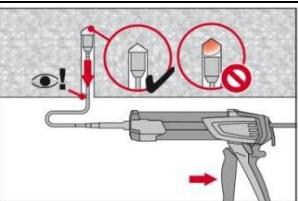

Overhead installation and/or installation with embedment depth $h_{ef} > 250\text{mm}$.

For overhead installation the injection is only possible with the aid of extensions and piston plugs. Assemble HIT-RE-M mixer, extension(s) and appropriately sized piston plug (HIT-SZ). Insert piston plug to back of the hole and inject adhesive. During injection the piston plug will be naturally extruded out of the bore hole by the adhesive pressure.

Setting the element

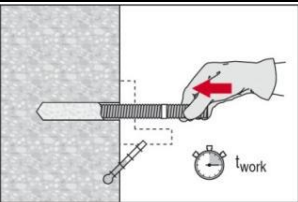

Before use, verify that the element is dry and free of oil and other contaminants.
Mark and set element to the required embedment depth until working time t_{work} has elapsed.

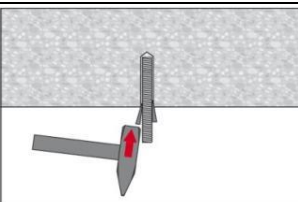

For overhead installation use piston plugs and fix embedded parts with e.g. wedges HIT-OHW.

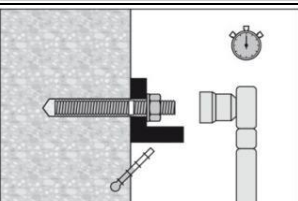

Loading the anchor:
After required curing time t_{cure} the anchor can be loaded.
The applied installation torque shall not exceed given T_{max} .

For detailed information on installation see instruction for use given with the package of the product.

Curing time for general conditions

Data according ETA-07/0260, issue 2013-06-26		
Temperature of the base material	Working time in which anchor can be inserted and adjusted t_{gel}	Curing time before anchor can be fully loaded t_{cure}
40 °C	12 min	4 h
30 °C to 39 °C	12 min	8 h
20 °C to 29 °C	20 min	12 h
15 °C to 19 °C	30 min	24 h
10 °C to 14 °C	90 min	48 h
5 °C to 9 °C	120 min	72 h

Setting details

		Data according ETA-07/0260, issue 2013-06-26								
Anchor size		Ø8	Ø10	Ø12	Ø14	Ø16	Ø20	Ø25	Ø28	Ø32
Nominal diameter of drill bit	d_0 [mm]	12	14	16	18	20	25	32	35	40
Effective anchorage and drill hole depth range ^{a)}	$h_{ef,min}$ [mm]	60	60	70	75	80	90	100	112	128
	$h_{ef,max}$ [mm]	160	200	240	280	320	400	500	560	640
Minimum base material thickness	h_{min} [mm]	$h_{ef} + 30 \text{ mm} \geq 100 \text{ mm}$			$h_{ef} + 2 d_0$					
Minimum spacing	s_{min} [mm]	40	50	60	70	80	100	125	140	160
Minimum edge distance	c_{min} [mm]	40	50	60	70	80	100	125	140	160
Critical spacing for splitting failure	$s_{cr,sp}$	$2 c_{cr,sp}$								
Critical edge distance for splitting failure ^{b)}	$c_{cr,sp}$ [mm]	$1,0 \cdot h_{ef}$ for $h / h_{ef} \geq 2,0$								
		$4,6 h_{ef} - 1,8 h$ for $2,0 > h / h_{ef} > 1,3$								
		$2,26 h_{ef}$ for $h / h_{ef} \leq 1,3$								
Critical spacing for concrete cone failure	$s_{cr,N}$	$2 c_{cr,N}$								
Critical edge distance for concrete cone failure ^{c)}	$c_{cr,N}$	$1,5 h_{ef}$								

For spacing (edge distance) smaller than critical spacing (critical edge distance) the design loads have to be reduced.

- a) $h_{ef,min} \leq h_{ef} \leq h_{ef,max}$ (h_{ef} : embedment depth)
- b) h : base material thickness ($h \geq h_{min}$)
- c) The critical edge distance for concrete cone failure depends on the embedment depth h_{ef} and the design bond resistance. The simplified formula given in this table is on the safe side.

Simplified design method

Simplified version of the design method according ETAG 001, TR 029. Design resistance according data given in ETA-07/0260, issue 2009-01-12.

- Influence of concrete strength
- Influence of edge distance
- Influence of spacing
- Valid for a group of two anchors. (The method may also be applied for anchor groups with more than two anchors or more than one edge distance. The influencing factors must then be considered for each edge distance and spacing. The calculated design loads are then on the same side: They will be lower than the exact values according ETAG 001, TR 029. To avoid this, it is recommended to use the anchor design software PROFIS anchor)

The design method is based on the following simplification:

- No different loads are acting on individual anchors (no eccentricity)

The values are valid for one anchor.

For more complex fastening applications please use the anchor design software PROFIS Anchor.

Tension loading

The design tensile resistance is the lower value of

- Steel resistance: $N_{Rd,s}$
- Combined pull-out and concrete cone resistance:
 $N_{Rd,p} = N_{Rd,p}^0 \cdot f_{B,p} \cdot f_{1,N} \cdot f_{2,N} \cdot f_{3,N} \cdot f_{h,p} \cdot f_{re,N}$
- Concrete cone resistance: $N_{Rd,c} = N_{Rd,c}^0 \cdot f_B \cdot f_{1,N} \cdot f_{2,N} \cdot f_{3,N} \cdot f_{h,N} \cdot f_{re,N}$
- Concrete splitting resistance (only non-cracked concrete):
 $N_{Rd,sp} = N_{Rd,c}^0 \cdot f_B \cdot f_{1,sp} \cdot f_{2,sp} \cdot f_{3,sp} \cdot f_{h,N} \cdot f_{re,N}$

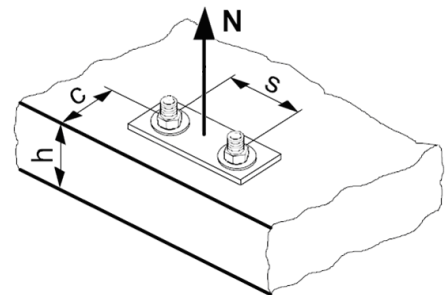

Basic design tensile resistance

Design steel resistance $N_{Rd,s}$

			Data according ETA-07/0260, issue 2013-06-26								
Anchor size			Ø8	Ø10	Ø12	Ø14	Ø16	Ø20	Ø25	Ø28	Ø32
$N_{Rd,s}$	BSt 500 S	[kN]	20,0	30,7	44,3	60,7	79,3	123,6	192,9	242,1	315,7

Design combined pull-out and concrete cone resistance

$$N_{Rd,p} = N_{Rd,p}^0 \cdot f_{B,p} \cdot f_{1,N} \cdot f_{2,N} \cdot f_{3,N} \cdot f_{h,p} \cdot f_{re,N}$$

Data according ETA-07/0260, issue 2013-06-26										
Anchor size	Ø8	Ø10	Ø12	Ø14	Ø16	Ø20	Ø25	Ø28	Ø32	
Typical embedment depth $h_{ef,typ}$ [mm]	80	90	110	125	125	170	210	270	300	
Non cracked concrete										
$N_{Rd,p}^0$ Temperature range I [kN]	16,8	23,6	34,6	42,8	41,9	71,2	102,1	147,0	186,7	
$N_{Rd,p}^0$ Temperature range II [kN]	13,4	18,8	27,6	36,7	32,9	56,0	86,4	113,1	143,6	
$N_{Rd,p}^0$ Temperature range III [kN]	7,8	11,0	16,1	21,4	20,9	33,1	51,1	67,9	86,2	
Cracked concrete										
$N_{Rd,p}^0$ Temperature range I [kN]	8,9	12,6	17,3	21,4	20,9	35,6	55,0	73,5	86,2	
$N_{Rd,p}^0$ Temperature range II [kN]	7,3	10,2	13,8	18,3	18,0	28,0	43,2	56,5	71,8	
$N_{Rd,p}^0$ Temperature range III [kN]	4,5	5,5	8,1	10,7	10,5	15,3	23,6	33,9	43,1	

$$\text{Design concrete cone resistance } N_{Rd,c} = N_{Rd,c}^0 \cdot f_B \cdot f_{1,N} \cdot f_{2,N} \cdot f_{3,N} \cdot f_{h,N} \cdot f_{re,N}$$

$$\text{Design splitting resistance } N_{Rd,sp} = N_{Rd,c}^0 \cdot f_B \cdot f_{1,sp} \cdot f_{2,sp} \cdot f_{3,sp} \cdot f_{h,N} \cdot f_{re,N}$$

Data according ETA-07/0260, issue 2013-06-26										
Anchor size	Ø8	Ø10	Ø12	Ø14	Ø16	Ø20	Ø25	Ø28	Ø32	
$N_{Rd,c}^0$ Non cracked concrete [kN]	20,1	24,0	32,4	39,2	33,6	53,3	73,2	106,7	125,0	
$N_{Rd,c}^0$ Cracked concrete [kN]	14,3	17,1	23,1	28,0	24,0	38,0	52,2	76,1	89,1	

a) Splitting resistance must only be considered for non-cracked concrete

Influencing factors

Influence of concrete strength on combined pull-out and concrete cone resistance

Concrete strength designation (ENV 206)	C 20/25	C 25/30	C 30/37	C 35/45	C 40/50	C 45/55	C 50/60
$f_{B,p} = (f_{ck,cube}/25N/mm^2)^{0,1}$ a)	1	1,02	1,04	1,06	1,07	1,08	1,09

a) $f_{ck,cube}$ = concrete compressive strength, measured on cubes with 150 mm side length

Influence of embedment depth on combined pull-out and concrete cone resistance

$$f_{h,p} = h_{ef}/h_{ef,typ}$$

Influence of concrete strength on concrete cone resistance

Concrete strength designation (ENV 206)	C 20/25	C 25/30	C 30/37	C 35/45	C 40/50	C 45/55	C 50/60
$f_B = (f_{ck,cube}/25N/mm^2)^{1/2}$ a)	1	1,1	1,22	1,34	1,41	1,48	1,55

a) $f_{ck,cube}$ = concrete compressive strength, measured on cubes with 150 mm side length

Influence of edge distance ^{a)}

$c/c_{cr,N}$	0,1	0,2	0,3	0,4	0,5	0,6	0,7	0,8	0,9	1
$c/c_{cr,sp}$										
$f_{1,N} = 0,7 + 0,3 \cdot c/c_{cr,N}$	0,73	0,76	0,79	0,82	0,85	0,88	0,91	0,94	0,97	1
$f_{1,sp} = 0,7 + 0,3 \cdot c/c_{cr,sp}$										
$f_{2,N} = 0,5 \cdot (1 + c/c_{cr,N})$	0,55	0,60	0,65	0,70	0,75	0,80	0,85	0,90	0,95	1
$f_{2,sp} = 0,5 \cdot (1 + c/c_{cr,sp})$										

a) The edge distance shall not be smaller than the minimum edge distance c_{min} given in the table with the setting details. These influencing factors must be considered for every edge distance smaller than the critical edge distance.

Influence of anchor spacing ^{a)}

$s/s_{cr,N}$	0,1	0,2	0,3	0,4	0,5	0,6	0,7	0,8	0,9	1
$s/s_{cr,sp}$										
$f_{3,N} = 0,5 \cdot (1 + s/s_{cr,N})$	0,55	0,60	0,65	0,70	0,75	0,80	0,85	0,90	0,95	1
$f_{3,sp} = 0,5 \cdot (1 + s/s_{cr,sp})$										

a) The anchor spacing shall not be smaller than the minimum anchor spacing s_{min} given in the table with the setting details. This influencing factor must be considered for every anchor spacing.

Influence of embedment depth on concrete cone resistance

$$f_{h,N} = (h_{ef}/h_{ef,typ})^{1,5}$$

Influence of reinforcement

h_{ef} [mm]	40	50	60	70	80	90	≥ 100
$f_{re,N} = 0,5 + h_{ef}/200mm \leq 1$	0,7 ^{a)}	0,75 ^{a)}	0,8 ^{a)}	0,85 ^{a)}	0,9 ^{a)}	0,95 ^{a)}	1

a) This factor applies only for dense reinforcement. If in the area of anchorage there is reinforcement with a spacing ≥ 150 mm (any diameter) or with a diameter ≤ 10 mm and a spacing ≥ 100 mm, then a factor $f_{re} = 1$ may be applied.

Shear loading

The design shear resistance is the lower value of

- Steel resistance: $V_{Rd,s}$
- Concrete pryout resistance: $V_{Rd,cp} = k \cdot \text{lower value of } N_{Rd,p} \text{ and } N_{Rd,c}$
- Concrete edge resistance: $V_{Rd,c} = V_{Rd,c}^0 \cdot f_B \cdot f_{\beta} \cdot f_h \cdot f_4 \cdot f_{hef} \cdot f_c$

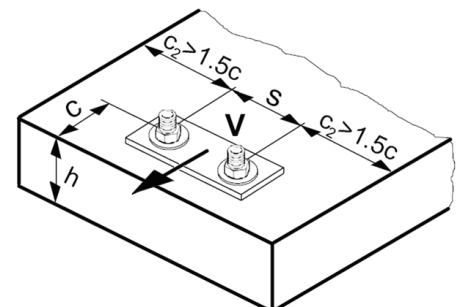

Basic design shear resistance

Design steel resistance $V_{Rd,s}$

		Data according ETA-07/0260, issue 2013-06-26								
Anchor size		Ø8	Ø10	Ø12	Ø14	Ø16	Ø20	Ø25	Ø28	Ø32
$V_{Rd,s}$	BSt 500 S [kN]	9,3	14,7	20,7	28,0	36,7	57,3	90,0	112,7	147,3

Design concrete pryout resistance $V_{Rd,cp}$ = lower value^{a)} of $k \cdot N_{Rd,p}$ and $k \cdot N_{Rd,c}$

$$k = 1 \text{ for } h_{ef} < 60 \text{ mm}$$

$$k = 2 \text{ for } h_{ef} \geq 60 \text{ mm}$$

- a) $N_{Rd,p}$: Design combined pull-out and concrete cone resistance
 $N_{Rd,c}$: Design concrete cone resistance

Design concrete edge resistance $V_{Rd,c} = V_{Rd,c}^0 \cdot f_B \cdot f_\beta \cdot f_h \cdot f_4 \cdot f_{hef} \cdot f_c$

		Data according ETA-07/0260, issue 2013-06-26								
Anchor size		Ø8	Ø10	Ø12	Ø14	Ø16	Ø20	Ø25	Ø28	Ø32
Non-cracked concrete										
$V_{Rd,c}^0$	[kN]	5,9	8,6	11,6	15,0	18,7	27,0	39,2	47,3	59,0
Cracked concrete										
$V_{Rd,c}^0$	[kN]	4,2	6,1	8,2	10,6	13,2	19,2	27,7	33,5	41,8

Influencing factors

Influence of concrete strength

Concrete strength designation (ENV 206)	C 20/25	C 25/30	C 30/37	C 35/45	C 40/50	C 45/55	C 50/60
$f_B = (f_{ck,cube}/25N/mm^2)^{1/2}$ a)	1	1,1	1,22	1,34	1,41	1,48	1,55

- a) $f_{ck,cube}$ = concrete compressive strength, measured on cubes with 150 mm side length

Influence of angle between load applied and the direction perpendicular to the free edge

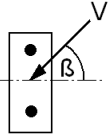
Angle β	0°	10°	20°	30°	40°	50°	60°	70°	80°	≥ 90°
$f_\beta = \frac{1}{\sqrt{(\cos \alpha_v)^2 + \left(\frac{\sin \alpha_v}{2,5}\right)^2}}$ 	1	1,01	1,05	1,13	1,24	1,40	1,64	1,97	2,32	2,50

Influence of base material thickness

h/c	0,15	0,3	0,45	0,6	0,75	0,9	1,05	1,2	1,35	≥ 1,5
$f_h = \{h/(1,5 \cdot c)\}^{1/2} \leq 1$	0,32	0,45	0,55	0,63	0,71	0,77	0,84	0,89	0,95	1,00

Influence of anchor spacing and edge distance ^{a)} for concrete edge resistance: f_4
 $f_4 = (c/h_{ef})^{1,5} \cdot (1 + s / [3 \cdot c]) \cdot 0,5$

c/h _{ef}	Single anchor	Group of two anchors s/h _{ef}														
		0,75	1,50	2,25	3,00	3,75	4,50	5,25	6,00	6,75	7,50	8,25	9,00	9,75	10,50	11,25
0,50	0,35	0,27	0,35	0,35	0,35	0,35	0,35	0,35	0,35	0,35	0,35	0,35	0,35	0,35	0,35	0,35
0,75	0,65	0,43	0,54	0,65	0,65	0,65	0,65	0,65	0,65	0,65	0,65	0,65	0,65	0,65	0,65	0,65
1,00	1,00	0,63	0,75	0,88	1,00	1,00	1,00	1,00	1,00	1,00	1,00	1,00	1,00	1,00	1,00	1,00
1,25	1,40	0,84	0,98	1,12	1,26	1,40	1,40	1,40	1,40	1,40	1,40	1,40	1,40	1,40	1,40	1,40
1,50	1,84	1,07	1,22	1,38	1,53	1,68	1,84	1,84	1,84	1,84	1,84	1,84	1,84	1,84	1,84	1,84
1,75	2,32	1,32	1,49	1,65	1,82	1,98	2,15	2,32	2,32	2,32	2,32	2,32	2,32	2,32	2,32	2,32
2,00	2,83	1,59	1,77	1,94	2,12	2,30	2,47	2,65	2,83	2,83	2,83	2,83	2,83	2,83	2,83	2,83
2,25	3,38	1,88	2,06	2,25	2,44	2,63	2,81	3,00	3,19	3,38	3,38	3,38	3,38	3,38	3,38	3,38
2,50	3,95	2,17	2,37	2,57	2,77	2,96	3,16	3,36	3,56	3,76	3,95	3,95	3,95	3,95	3,95	3,95
2,75	4,56	2,49	2,69	2,90	3,11	3,32	3,52	3,73	3,94	4,15	4,35	4,56	4,56	4,56	4,56	4,56
3,00	5,20	2,81	3,03	3,25	3,46	3,68	3,90	4,11	4,33	4,55	4,76	4,98	5,20	5,20	5,20	5,20
3,25	5,86	3,15	3,38	3,61	3,83	4,06	4,28	4,51	4,73	4,96	5,18	5,41	5,63	5,86	5,86	5,86
3,50	6,55	3,51	3,74	3,98	4,21	4,44	4,68	4,91	5,14	5,38	5,61	5,85	6,08	6,31	6,55	6,55
3,75	7,26	3,87	4,12	4,36	4,60	4,84	5,08	5,33	5,57	5,81	6,05	6,29	6,54	6,78	7,02	7,26
4,00	8,00	4,25	4,50	4,75	5,00	5,25	5,50	5,75	6,00	6,25	6,50	6,75	7,00	7,25	7,50	7,75
4,25	8,76	4,64	4,90	5,15	5,41	5,67	5,93	6,18	6,44	6,70	6,96	7,22	7,47	7,73	7,99	8,25
4,50	9,55	5,04	5,30	5,57	5,83	6,10	6,36	6,63	6,89	7,16	7,42	7,69	7,95	8,22	8,49	8,75
4,75	10,35	5,45	5,72	5,99	6,27	6,54	6,81	7,08	7,36	7,63	7,90	8,17	8,45	8,72	8,99	9,26
5,00	11,18	5,87	6,15	6,43	6,71	6,99	7,27	7,55	7,83	8,11	8,39	8,66	8,94	9,22	9,50	9,78
5,25	12,03	6,30	6,59	6,87	7,16	7,45	7,73	8,02	8,31	8,59	8,88	9,17	9,45	9,74	10,02	10,31
5,50	12,90	6,74	7,04	7,33	7,62	7,92	8,21	8,50	8,79	9,09	9,38	9,67	9,97	10,26	10,55	10,85

a) The anchor spacing and the edge distance shall not be smaller than the minimum anchor spacing s_{min} and the minimum edge distance c_{min} .

Influence of embedment depth

h _{ef} /d	4	4,5	5	6	7	8	9	10	11
f _{hef} = 0,05 · (h _{ef} / d) ^{1,68}	0,51	0,63	0,75	1,01	1,31	1,64	2,00	2,39	2,81
h _{ef} /d	12	13	14	15	16	17	18	19	20
f _{hef} = 0,05 · (h _{ef} / d) ^{1,68}	3,25	3,72	4,21	4,73	5,27	5,84	6,42	7,04	7,67

Influence of edge distance ^{a)}

c/d	4	6	8	10	15	20	30	40
f _c = (d / c) ^{0,19}	0,77	0,71	0,67	0,65	0,60	0,57	0,52	0,50

a) The edge distance shall not be smaller than the minimum edge distance c_{min} .

Combined tension and shear loading

For combined tension and shear loading see section "Anchor Design".

Precalculated values

Recommended loads can be calculated by dividing the design resistance by an overall partial safety factor for action $\gamma = 1,4$. The partial safety factors for action depend on the type of loading and shall be taken from national regulations.

Design resistance: concrete C 20/25 – $f_{ck,cube} = 25 \text{ N/mm}^2$, Temperature range I

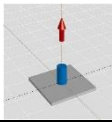
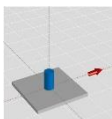
		Data according ETA-07/0260, issue 2013-06-26								
Anchor size		Ø8	Ø10	Ø12	Ø14	Ø16	Ø20	Ø25	Ø28	Ø32
Embedment depth $h_{ef,1} =$ [mm]		60	60	72	84	96	120	150	168	192
Base material thickness $h_{min} =$ [mm]		100	100	104	120	136	170	214	238	272
Tensile N_{Rd}: single anchor, no edge effects										
Non cracked concrete										
 BSt 500 S	[kN]	12,6	13,0	17,1	21,6	22,6	31,6	44,2	52,4	64,0
Cracked concrete										
BSt 500 S	[kN]	6,7	8,4	11,3	14,4	16,1	22,5	31,5	37,3	45,6
Shear V_{Rd}: single anchor, no edge effects, without lever arm										
Non cracked concrete										
 BSt 500 S	[kN]	9,3	14,7	20,7	28,0	36,7	57,3	90,0	112,7	147,3
Cracked concrete										
BSt 500 S	[kN]	9,3	14,7	20,7	28,0	36,7	57,3	88,2	104,5	127,7

Design resistance: concrete C 20/25 – $f_{ck,cube} = 25 \text{ N/mm}^2$, Temperature range I

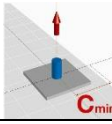
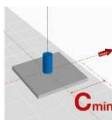
		Data according ETA-07/0260, issue 2013-06-26								
Anchor size		Ø8	Ø10	Ø12	Ø14	Ø16	Ø20	Ø25	Ø28	Ø32
Embedment depth $h_{ef,1} =$ [mm]		60	60	72	84	96	120	150	168	192
Base material thickness $h_{min} =$ [mm]		100	100	104	120	136	170	214	238	272
Edge distance $c = c_{min} =$ [mm]		40	50	60	70	80	100	125	140	160
Tensile N_{Rd}: single anchor, min. edge distance ($c = c_{min}$)										
Non cracked concrete										
 BSt 500 S	[kN]	7,6	8,5	10,0	12,5	13,1	18,3	25,6	30,3	37,0
Cracked concrete										
BSt 500 S	[kN]	4,0	5,6	7,6	9,7	10,8	15,2	21,2	25,2	30,7
Shear V_{Rd}: single anchor, min. edge distance ($c = c_{min}$), without lever arm										
Non cracked concrete										
 BSt 500 S	[kN]	3,5	4,9	6,7	8,6	10,8	15,7	22,9	27,7	34,6
Cracked concrete										
BSt 500 S	[kN]	2,5	3,5	4,7	6,1	7,6	11,1	16,2	19,6	24,5

Design resistance: concrete C 20/25 – $f_{ck,cube} = 25 \text{ N/mm}^2$, Temperature range I (load values are valid for single anchor)

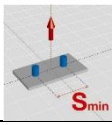
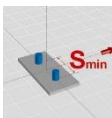
		Data according ETA-07/0260, issue 2013-06-26								
Anchor size		Ø8	Ø10	Ø12	Ø14	Ø16	Ø20	Ø25	Ø28	Ø32
Embedment depth $h_{ef,1} =$ [mm]		60	60	72	84	96	120	150	168	192
Base material thickness $h_{min} =$ [mm]		100	100	104	120	136	170	214	238	272
Spacing $s = s_{min} =$ [mm]		40	50	60	70	80	100	125	140	160
Tensile N_{Rd}: double anchor, no edge effects, min. spacing ($s = s_{min}$)										
Non cracked concrete										
 BSt 500 S	[kN]	7,8	8,2	10,4	13,0	13,6	19,0	26,6	31,5	38,5
Cracked concrete										
BSt 500 S	[kN]	4,4	5,5	7,4	9,3	9,7	13,6	19,0	22,5	27,4
Shear V_{Rd}: double anchor, no edge effects, min. spacing ($s = s_{min}$), without lever arm										
Non cracked concrete										
 BSt 500 S	[kN]	9,3	14,7	20,7	28,0	36,7	56,5	79,0	93,7	114,4
Cracked concrete										
BSt 500 S	[kN]	9,3	12,8	17,3	22,0	28,8	40,3	56,3	66,8	81,6

Design resistance: concrete C 20/25 – $f_{ck,cube} = 25 \text{ N/mm}^2$, Temperature range I

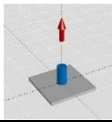
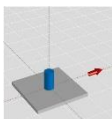
		Data according ETA-07/0260, issue 2013-06-26								
Anchor size		Ø8	Ø10	Ø12	Ø14	Ø16	Ø20	Ø25	Ø28	Ø32
Embedment depth $h_{ef,typ} =$ [mm]		80	90	110	125	125	170	210	270	300
Base material thickness $h_{min} =$ [mm]		110	120	142	161	165	220	274	340	380
		Tensile N_{Rd}: single anchor, no edge effects								
		Non cracked concrete								
BSt 500 S	[kN]	16,8	23,6	32,4	39,2	33,6	53,3	73,2	106,7	125,0
		Cracked concrete								
BSt 500 S	[kN]	8,9	12,6	17,3	21,4	20,9	35,6	52,2	73,5	86,2
		Shear V_{Rd}: single anchor, no edge effects, without lever arm								
		Non cracked concrete								
BSt 500 S	[kN]	9,3	14,7	20,7	28,0	36,7	57,3	90,0	112,7	147,3
		Cracked concrete								
BSt 500 S	[kN]	9,3	14,7	20,7	28,0	36,7	57,3	90,0	112,7	147,3

Design resistance: concrete C 20/25 – $f_{ck,cube} = 25 \text{ N/mm}^2$, Temperature range I

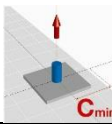
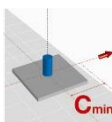
		Data according ETA-07/0260, issue 2013-06-26								
Anchor size		Ø8	Ø10	Ø12	Ø14	Ø16	Ø20	Ø25	Ø28	Ø32
Embedment depth $h_{ef,typ} =$ [mm]		80	90	110	125	125	170	210	270	300
Base material thickness $h_{min} =$ [mm]		110	120	142	161	165	220	274	340	380
Edge distance $c = c_{min} =$ [mm]		40	50	60	70	80	100	125	140	160
		Tensile N_{Rd}: single anchor, min. edge distance ($c = c_{min}$)								
		Non cracked concrete								
BSt 500 S	[kN]	9,1	11,6	15,5	18,9	17,0	26,1	36,1	50,4	59,5
		Cracked concrete								
BSt 500 S	[kN]	4,3	6,0	8,4	10,5	10,3	17,4	25,7	35,9	42,4
		Shear V_{Rd}: single anchor, min. edge distance ($c = c_{min}$), without lever arm								
		Non cracked concrete								
BSt 500 S	[kN]	3,7	5,3	7,3	9,5	11,5	17,2	25,0	31,6	39,3
		Cracked concrete								
BSt 500 S	[kN]	2,6	3,8	5,2	6,7	8,1	12,2	17,7	22,4	27,9

Design resistance: concrete C 20/25 – $f_{ck,cube} = 25 \text{ N/mm}^2$, Temperature range I
(load values are valid for single anchor)

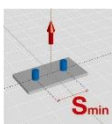
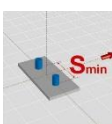
		Data according ETA-07/0260, issue 2013-06-26								
Anchor size		Ø8	Ø10	Ø12	Ø14	Ø16	Ø20	Ø25	Ø28	Ø32
Embedment depth $h_{ef,typ} =$ [mm]		80	90	110	125	125	170	210	270	300
Base material thickness $h_{min} =$ [mm]		110	120	142	161	165	220	274	340	380
Spacing $s = s_{min} =$ [mm]		40	50	60	70	80	100	125	140	160
		Tensile N_{Rd}: double anchor, no edge effects, min. spacing ($s = s_{min}$)								
		Non cracked concrete								
BSt 500 S	[kN]	10,4	13,5	18,1	22,0	19,2	30,1	41,4	59,5	69,8
		Cracked concrete								
BSt 500 S	[kN]	5,9	8,1	11,1	13,7	13,2	21,5	29,5	42,4	49,8
		Shear V_{Rd}: double anchor, no edge effects, min. spacing ($s = s_{min}$), without lever arm								
		Non cracked concrete								
BSt 500 S	[kN]	9,3	14,7	20,7	28,0	36,7	57,3	90,0	112,7	147,3
		Cracked concrete								
BSt 500 S	[kN]	9,3	14,7	20,7	28,0	35,6	57,3	87,5	112,7	142,1

Design resistance: concrete C 20/25 – $f_{ck,cube} = 25 \text{ N/mm}^2$, Temperature range I

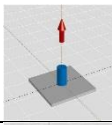
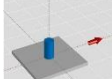
		Data according ETA-07/0260, issue 2013-06-26								
Anchor size		Ø8	Ø10	Ø12	Ø14	Ø16	Ø20	Ø25	Ø28	Ø32
Embedment depth $h_{ef,2} =$ [mm]		96	120	144	168	192	240	300	336	384
Base material thickness $h_{min} =$ [mm]		126	150	176	204	232	290	364	406	464
Tensile N_{Rd}: single anchor, no edge effects										
Non cracked concrete										
 BSt 500 S	[kN]	20,0	30,7	44,3	57,5	64,0	89,4	125,0	148,1	181,0
Cracked concrete										
BSt 500 S	[kN]	10,7	16,8	22,6	28,7	32,2	50,3	78,5	91,5	110,3
Shear V_{Rd}: single anchor, no edge effects, without lever arm										
Non cracked and cracked concrete										
 BSt 500 S	[kN]	9,3	14,7	20,7	28,0	36,7	57,3	90,0	112,7	147,3

Design resistance: concrete C 20/25 – $f_{ck,cube} = 25 \text{ N/mm}^2$, Temperature range I

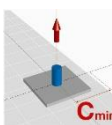
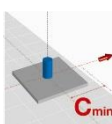
		Data according ETA-07/0260, issue 2013-06-26								
Anchor size		Ø8	Ø10	Ø12	Ø14	Ø16	Ø20	Ø25	Ø28	Ø32
Embedment depth $h_{ef,2} =$ [mm]		96	120	144	168	192	240	300	336	384
Base material thickness $h_{min} =$ [mm]		126	150	176	204	232	290	364	406	464
Edge distance $c = c_{min} =$ [mm]		40	50	60	70	80	100	125	140	160
Tensile N_{Rd}: single anchor, min. edge distance ($c = c_{min}$)										
Non cracked concrete										
 BSt 500 S	[kN]	11,0	16,5	21,7	27,3	28,6	40,0	55,9	66,2	80,9
Cracked concrete										
BSt 500 S	[kN]	5,8	9,1	12,3	15,9	17,8	27,8	44,1	51,4	61,9
Shear V_{Rd}: single anchor, min. edge distance ($c = c_{min}$), without lever arm										
Non cracked and cracked concrete										
 BSt 500 S	[kN]	3,9	5,7	7,8	10,2	12,9	18,9	27,8	33,9	42,6
Cracked concrete										
BSt 500 S	[kN]	2,8	4,0	5,5	7,2	9,1	13,4	19,7	24,0	30,2

Design resistance: concrete C 20/25 – $f_{ck,cube} = 25 \text{ N/mm}^2$, Temperature range I (load values are valid for single anchor)

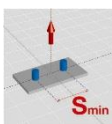
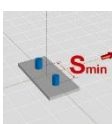
		Data according ETA-07/0260, issue 2013-06-26								
Anchor size		Ø8	Ø10	Ø12	Ø14	Ø16	Ø20	Ø25	Ø28	Ø32
Embedment depth $h_{ef,2} =$ [mm]		96	120	144	168	192	240	300	336	384
Base material thickness $h_{min} =$ [mm]		126	150	176	204	232	290	364	406	464
Spacing $s = s_{min} =$ [mm]		40	50	60	70	80	100	125	140	160
Tensile N_{Rd}: double anchor, no edge effects, min. spacing ($s = s_{min}$)										
Non cracked concrete										
 BSt 500 S	[kN]	12,8	19,4	26,5	33,4	34,9	48,8	68,2	80,9	98,8
Cracked concrete										
BSt 500 S	[kN]	7,2	11,0	14,8	18,9	20,9	31,9	48,6	56,9	68,9
Shear V_{Rd}: double anchor, no edge effects, min. spacing ($s = s_{min}$), without lever arm										
Non cracked concrete										
 BSt 500 S	[kN]	9,3	14,7	20,7	28,0	36,7	57,3	90,0	112,7	147,3
Cracked concrete										
BSt 500 S	[kN]	9,3	14,7	20,7	28,0	36,7	57,3	90,0	112,7	147,3

Seismic design C1

Basic loading data for concrete C20/25 – C50/60

All data in this section applies to:

- Seismic design according to TR045

The following technical data are based on: ETA-07/0260, issue 2013-06-26

Anchorage depth range

Anchor size		Φ8	Φ10	Φ12	Φ14	Φ16	Φ20	Φ25	Φ26	Φ28	Φ30	Φ32
Effective anchorage	$h_{ef,min}$ [mm]	60	60	70	80	80	90	100	104	115	120	130
depth range	$h_{ef,max}$ [mm]	160	200	240	280	320	400	500	520	540	600	660

Tension resistance in case of seismic performance category C1

Anchor size		Φ8	Φ10	Φ12	Φ14	Φ16	Φ20	Φ25	Φ26	Φ28	Φ30	Φ32
Characteristic tension resistance to steel failure												
Rebar B500B	$N_{Rk,s,seis}$ [kN]	28	43	62	85	111	173	270	-	339	-	442
Acc. to DIN 488:2009-08												
Partial safety factor	$\gamma_{Ms,seis}$ [-]	1,4						-	1,4	-	1,4	
Acc. to DIN 488:2009-08												
Characteristic bond resistance in cracked concrete C20/25 to C50/60												
Temp. range I: 40°C/24°C	$\tau_{Rk,seis}$ [N/mm ²]	6,4	6,4	6	5,4	5,3	5	4,6	4,5	4	3,6	3,4
Temp. range II: 58°C/35°C	$\tau_{Rk,seis}$ [N/mm ²]	5,2	5,2	4,8	4,7	4,5	3,9	3,6	3,5	3,1	3,0	2,9
Temp. range III: 70°C/43°C	$\tau_{Rk,seis}$ [N/mm ²]	3,2	2,8	2,8	2,7	2,6	2,1	2	1,9	1,8	1,8	1,7
Partial safety factor	$\gamma_{Mp,seis}$ [-]	1,8					2,1					
Concrete cone resistance and splitting resistance												
Partial safety factor	$\gamma_{Mc,seis} = \gamma_{Msp,seis}$ [-]	1,8					2,1					

Displacement under tension load in case of seismic performance category C1 ¹⁾

Anchor size		Φ8	Φ10	Φ12	Φ14	Φ16	Φ20	Φ25	Φ26	Φ28	Φ30	Φ32
Displacement ¹⁾	$\delta_{N,seis}$ [mm]	1,5	1,7	1,9	2,1	2,3	2,7	3,2	3,3	3,5	3,7	3,9

1) Maximum displacement during cycling (seismic event).

Shear resistance in case of seismic performance category C1

Anchor size	Ø8	Ø10	Ø12	Ø14	Ø16	Ø20	Ø25	Ø26	Ø28	Ø30	Ø32
Characteristic shear resistance to steel failure											
Rebar B500B Acc. to DIN 488:2009-08 $N_{Rk,s,seis}$ [kN]	10	15	22	29	39	60	95	-	118	-	155
Partial safety factor Acc. to DIN 488:2009-08 $\gamma_{Ms,seis}$ [-]	1,5							-	1,5	-	1,5
Concrete pryout resistance and concrete edge resistance											
Partial safety factor $\gamma_{Mcp,seis}$ = $\gamma_{Mc,seis}$ [-]	1,5										





Displacement under shear load in case of seismic performance category C1 ¹⁾

Anchor size	Ø8	Ø10	Ø12	Ø14	Ø16	Ø20	Ø25	Ø26	Ø28	Ø30	Ø32
Displacement ¹⁾ $\delta_{V,seis}$ [mm]	3,2	3,5	3,8	4,1	4,4	5,0	5,8	5,9	6,2	6,5	6,8

1) Maximum displacement during cycling (seismic event).

For seismic resistant fastening applications please use the anchor design software PROFIS Anchor.

Hilti HIT-RE 500-SD mortar with HIT-CS(-F) rod

Injection mortar system		Benefits
	Hilti HIT-RE 500-SD (available as 330 ml, 500 ml or 1400 ml foil pack)	<ul style="list-style-type: none"> - suitable for cracked and non-cracked concrete C 20/25 to C 50/60 - wet and dry concrete - high loading capacity - 8.8. steel grade - hot dip galvanized coating 55 µm (HIT-CS-F) - electrogalvanized 5 µm (HIT-CS)
	Static mixer	
	HIT-CS-F rod (55µm)	
	HIT-CS rod (5µm)	

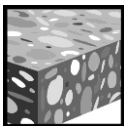

Concrete



Tensile zone

Approvals / certificates

Description	Authority / Laboratory	No. / date of issue
Test report	CMA *	20121C01764 / 2012-08-10

* National Research Center of Testing Techniques for Building Materials, only valid for HIT-CS-F

Basic loading data (for a single anchor)

All data in this section is Hilti technical data and applies to

For details see Simplified design method

- Correct setting (See setting instruction)
- No edge distance and spacing influence
- Steel failure
- Concrete C 20/25, $f_{ck,cube} = 25 \text{ N/mm}^2$
- min. in service base material temperature -40°C , max. long term/short term base material temperature: $+24^\circ\text{C}/40^\circ\text{C}$
- Installation temperature range $+5^\circ\text{C}$ to $+40^\circ\text{C}$

Mean Ultimate Resistance

Anchor size		non-cracked concrete			cracked concrete		
		M12x110	M16x125	M20x170	M12x110	M16x125	M20x170
Tensile $N_{Ru,m}$	[kN]	68,6	93,7	148,6	55,1	66,8	105,9
Shear $V_{Ru,m}$	[kN]	35,4	65,9	102,9	35,4	65,9	102,9

Characteristic Resistance

Anchor size	non-cracked concrete			cracked concrete		
	M12x110	M16x125	M20x170	M12x110	M16x125	M20x170
Tensile N_{Rk} [kN]	58,3	70,6	111,9	41,5	50,3	79,8
Shear V_{Rk} [kN]	33,7	62,8	98,0	33,7	62,8	98,0

Design Resistance

Anchor size	non-cracked concrete			cracked concrete		
	M12x110	M16x125	M20x170	M12x110	M16x125	M20x170
Tensile N_{Rd} [kN]	32,4	39,2	62,2	23,1	28,0	44,3
Shear V_{Rd} [kN]	27,0	50,2	78,4	27,0	50,2	78,4

Recommended loads ^{a)}

Anchor size	non-cracked concrete			cracked concrete		
	M12x110	M16x125	M20x170	M12x110	M16x125	M20x170
Tensile N_{rec} [kN]	23,1	28,0	44,4	16,5	20,0	31,7
Shear V_{rec} [kN]	19,3	35,9	56,0	19,3	35,9	56,0

c) With overall partial safety factor for action $\gamma = 1,4$. The partial safety factors for action depend on the type of loading and shall be taken from national regulations.

Materials

Mechanical properties of HIT-CS-F

Anchor size	M12x110	M16x125	M20x170
Nominal tensile strength f_{uk} [N/mm ²]	800	800	800
Yield strength f_{yk} [N/mm ²]	640	640	640
Stressed cross-section of the thread for shear A_s [mm ²]	84,3	157	245
relevant cross-section for tensile loading $A_{s,c}$ [mm ²]	81,7	157	237,8
Moment of resistance W [mm ³]	109	277	541
Char. bending resistance $M_{Rk,s}^0$ with 8.8 Steel Grade [Nm]	105	266	519

Material quality

Part	Material	
	HIT-CS-F	HIT-CS
Anchor Body	Carbon steel; hot dip galvanized to min. 55 μ m, coated	Carbon steel; electrogalvanized to min. 5 μ m, coated
Washer	DIN 934-class 8-AZ (according to DIN ISO 965-5); hot dip galvanized to min. 55 μ m	Property class 8 acc.to DIN EN ISO 898-2, electrogalvanized to min. 5 μ m
Nut	Carbon steel; hot dip galvanized to min. 55 μ m	DIN 125-1-size-140HV, electrogalvanized to min. 5 μ m

Anchor dimensions of HIT-CS-F

Anchor size			M12x110	M16x125	M20x170
Norminal diameter	d_1	[mm]	12	16	20
Length of anchor	l_1	[mm]	160 to 660	190 to 675	240 to 720
Embedment depth	$l_2 = h_{nom}$	[mm]	110	125	170
Length of thread	l_3	[mm]	50 to 550	65 to 550	70 to 550
Length of helix	l_4	[mm]	60	80	110

Anchor rod

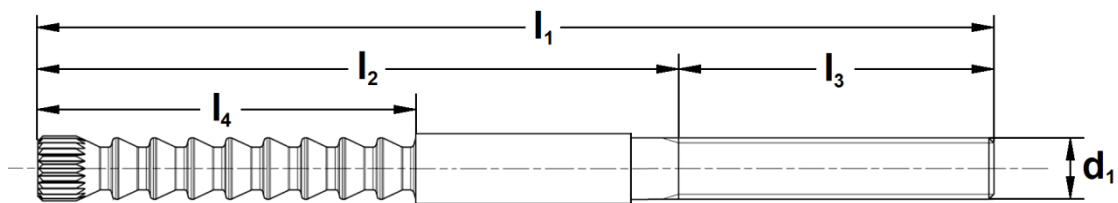

Setting

Installation equipment

Anchor size	M12x110	M16x125	M20x170
Rotary hammer	TE 16 – TE 80		
Other tools	Compressed air gun, set of brushes, dispenser		

Setting instruction

For detailed information on installation see instruction for use given with the package of the product.

HIT-CS-F	Ø d ₀ [mm]	h ₁ [mm]
M12 x 110	Ø 14	115
M16 x 125	Ø 18	130
M20 x 170	Ø 24	175

HIT-CS-F	d _i [mm]	SW [mm]	T _{inst} [Nm]
M12 x 110	14	19	40
M16 x 125	18	24	80
M20 x 170	22	30	150

Curing time for general conditions

Temperature of the base material	Working time in which anchor can be inserted and adjusted t _{gel}	Curing time before anchor can be fully loaded t _{cure}
40 °C	12 min	4 h
30 °C to 39 °C	12 min	8 h
20 °C to 29 °C	20 min	12 h
15 °C to 19 °C	30 min	24 h
10 °C to 14 °C	90 min	48 h
5 °C to 9 °C	120 min	72 h

Setting details

Anchor size		M12x110		M16x125		M20x170	
		HIT-CS-F	HIT-CS	HIT-CS-F	HIT-CS	HIT-CS-F	HIT-CS
Nominal diameter of drill bit	d_o [mm]	14		18		22	
Cutting diameter of drill bit	$d_{cut} \leq$ [mm]	14,5		18,5		22,5	
Effective anchorage depth	h_{ef} [mm]	102		117		158	
Nominal anchorage depth	h_{nom} [mm]	110		125		170	
Depth of drill hole	$h_1 \geq$ [mm]	115		130		175	
Minimum base material thickness	$h_{min}^{a)}$ [mm]	140		170	200	230	250
Diameter of clearance hole in the fixture	$d_f \leq$ [mm]	14		18		22	
Minimum spacing and minimum edge distance	s_{min} [mm]	60	90	80	100	100	120
	c_{min} [mm]	60	90	80	100	100	120
Critical edge distance for splitting failure	$s_{cr,sp}$ [mm]	7 hef		7 hef		7 hef	
	$c_{cr,sp}$ [mm]	3,5 hef		3,5 hef		3,5 hef	
Critical edge distance for concrete cone failure	$s_{cr,N}$ [mm]	330		375		510	
	$c_{cr,N}$ [mm]	165		187,5		255	
Max. torque moment	T_{inst} [Nm]	40		80		150	

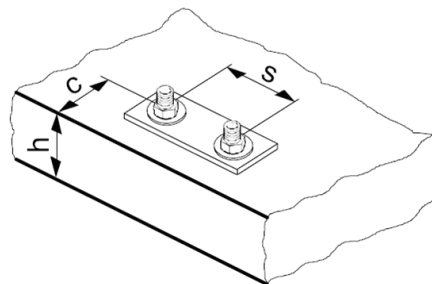

For spacing (edge distance) smaller than critical spacing (critical edge distance) the design loads have to be reduced.

a) h : base material thickness ($h \geq h_{min}$)

Simplified design method

Simplified version of the design method according ETAG 001, Annex C.

- Influence of concrete strength
- Influence of edge distance
- Influence of spacing
- Valid for a group of two anchors. The method may also be applied for anchor groups with more than two anchors or more than one edge distance. The influencing factors must then be considered for each edge distance and spacing.

The design method is based on the following simplification:

- No different loads are acting on individual anchors (no eccentricity)

The values are valid for one anchor.

Tension loading

The design tensile resistance is the lower value of

- Steel resistance: $N_{Rd,s}$
- Pull-out resistance: $N_{Rd,p} = N_{Rd,p}^0 \cdot f_B$
- Concrete cone resistance: $N_{Rd,c} = N_{Rd,c}^0 \cdot f_B \cdot f_{1,N} \cdot f_{2,N} \cdot f_{3,N}$
- Concrete splitting resistance (only non-cracked concrete):
 $N_{Rd,sp} = N_{Rd,c}^0 \cdot f_B \cdot f_{1,sp} \cdot f_{2,sp} \cdot f_{3,sp} \cdot f_{h,sp}$

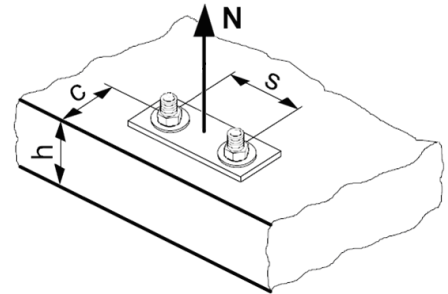

Basic design tensile resistance

Design steel resistance $N_{Rd,s}$

Anchor size	M12	M16	M20
$N_{Rd,s}$ [kN]	43,6	98,1	126,8

Design pull-out a resistance $N_{Rd,p} = N_{Rd,p}^0$

Anchor size	Non-cracked concrete			Cracked concrete		
	M12	M16	M20	M12	M16	M20
Embedment depth h_{ef} [mm]	110	125	170	110	125	170
$N_{Rd,p}^0$ [kN]	No pull-out failure					

Design concrete cone resistance $N_{Rd,c} = N_{Rd,c}^0 \cdot f_B \cdot f_{1,N} \cdot f_{2,N} \cdot f_{3,N}$

Design splitting resistance $N_{Rd,sp} = N_{Rd,c}^0 \cdot f_B \cdot f_{1,sp} \cdot f_{2,sp} \cdot f_{3,sp}$

Anchor size	Non-cracked concrete			Cracked concrete		
	M12	M16	M20	M12	M16	M20
$N_{Rd,c}^0$ [kN]	32,4	39,2	62,2	23,1	28,0	44,3

Influencing factors

Influence of concrete strength on concrete cone resistance

Concrete strength designation (ENV 206)	C 20/25	C 25/30	C 30/37	C 35/45	C 40/50	C 45/55	C 50/60
$f_B = (f_{ck,cube}/25N/mm^2)^{0,5}$ a)	1	1,1	1,22	1,34	1,41	1,48	1,55

a) $f_{ck,cube}$ = concrete compressive strength, measured on cubes with 150 mm side length

Influence of edge distance ^{a)}

$c/c_{cr,N}$	0,1	0,2	0,3	0,4	0,5	0,6	0,7	0,8	0,9	1
$c/c_{cr,sp}$										
$f_{1,N} = 0,7 + 0,3 \cdot c/c_{cr,N}$	0,73	0,76	0,79	0,82	0,85	0,88	0,91	0,94	0,97	1
$f_{1,sp} = 0,7 + 0,3 \cdot c/c_{cr,sp}$										
$f_{2,N} = 0,5 \cdot (1 + c/c_{cr,N})$	0,55	0,60	0,65	0,70	0,75	0,80	0,85	0,90	0,95	1
$f_{2,sp} = 0,5 \cdot (1 + c/c_{cr,sp})$										

a) The the edge distance shall not be smaller than the minimum edge distance c_{min} given in the table with the setting details. These influencing factors must be considered for every edge distance smaller than the critical edge distance.

Influence of anchor spacing ^{a)}

$s/s_{cr,N}$	0,1	0,2	0,3	0,4	0,5	0,6	0,7	0,8	0,9	1
$s/s_{cr,sp}$										
$f_{3,N} = 0,5 \cdot (1 + s/s_{cr,N})$	0,55	0,60	0,65	0,70	0,75	0,80	0,85	0,90	0,95	1
$f_{3,sp} = 0,5 \cdot (1 + s/s_{cr,sp})$										

a) The anchor spacing shall not be smaller than the minimum anchor spacing s_{min} given in the table with the setting details. This influencing factor must be considered for every anchor spacing.

Shear loading

The design shear resistance is the lower value of

- Steel resistance: $V_{Rd,s}$
- Concrete pryout resistance: $V_{Rd,cp} = k \cdot \text{lower value of } N_{Rd,p} \text{ and } N_{Rd,c}$
- Concrete edge resistance: $V_{Rd,c} = V_{Rd,c}^0 \cdot f_B \cdot f_{fB} \cdot f_h \cdot f_4$

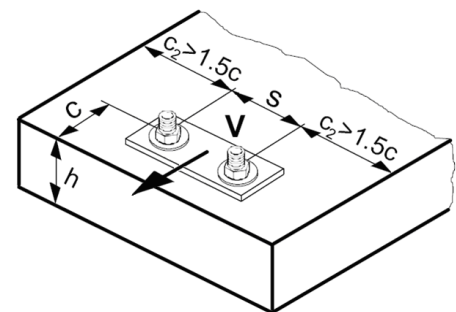

Basic design shear resistance

Design steel resistance $V_{Rd,s}$

Anchor size	M12	M16	M20
$V_{Rd,s}$ HIT-CS-F [kN]	27,0	50,2	78,4

Design concrete pryout resistance $V_{Rd,cp} = k \cdot N_{Rd,c}$

$$k = 2$$

Design concrete edge resistance ^{a)} $V_{Rd,c} = V_{Rd,c}^0 \cdot f_B \cdot f_{fB} \cdot f_h \cdot f_4$

Anchor size	Non-cracked concrete			Cracked concrete		
	M12	M16	M20	M12	M16	M20
$V_{Rd,c}^0$ [kN]	11,6	18,7	27,0	8,2	13,2	19,2

a) For anchor groups only the anchors close to the edge must be considered.

Influencing factors

Influence of concrete strength

Concrete strength designation (ENV 206)	C 20/25	C 25/30	C 30/37	C 35/45	C 40/50	C 45/55	C 50/60
$f_B = (f_{ck,cube}/25N/mm^2)^{1/2}$ a)	1	1,1	1,22	1,34	1,41	1,48	1,55

a) $f_{ck,cube}$ = concrete compressive strength, measured on cubes with 150 mm side length

Influence of angle between load applied and the direction perpendicular to the free edge

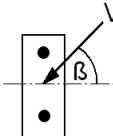
Angle β	0°	10°	20°	30°	40°	50°	60°	70°	80°	≥ 90°
$f_\beta = \sqrt{\frac{1}{(\cos \alpha_v)^2 + \left(\frac{\sin \alpha_v}{2,5}\right)^2}}$ 	1	1,01	1,05	1,13	1,24	1,40	1,64	1,97	2,32	2,50

Influence of base material thickness

h/c	0,15	0,3	0,45	0,6	0,75	0,9	1,05	1,2	1,35	≥ 1,5
$f_h = \{h/(1,5 \cdot c)\}^{2/3} \leq 1$	0,22	0,34	0,45	0,54	0,63	0,71	0,79	0,86	0,93	1,00

Influence of anchor spacing and edge distance a) for concrete edge resistance: f_4

$$f_4 = (c/h_{ef})^{1,5} \cdot (1 + s / [3 \cdot c]) \cdot 0,5$$

c/h _{ef}	Single anchor	Group of two anchors s/h _{ef}														
		0,75	1,50	2,25	3,00	3,75	4,50	5,25	6,00	6,75	7,50	8,25	9,00	9,75	10,50	11,25
0,50	0,35	0,27	0,35	0,35	0,35	0,35	0,35	0,35	0,35	0,35	0,35	0,35	0,35	0,35	0,35	0,35
0,75	0,65	0,43	0,54	0,65	0,65	0,65	0,65	0,65	0,65	0,65	0,65	0,65	0,65	0,65	0,65	0,65
1,00	1,00	0,63	0,75	0,88	1,00	1,00	1,00	1,00	1,00	1,00	1,00	1,00	1,00	1,00	1,00	1,00
1,25	1,40	0,84	0,98	1,12	1,26	1,40	1,40	1,40	1,40	1,40	1,40	1,40	1,40	1,40	1,40	1,40
1,50	1,84	1,07	1,22	1,38	1,53	1,68	1,84	1,84	1,84	1,84	1,84	1,84	1,84	1,84	1,84	1,84
1,75	2,32	1,32	1,49	1,65	1,82	1,98	2,15	2,32	2,32	2,32	2,32	2,32	2,32	2,32	2,32	2,32
2,00	2,83	1,59	1,77	1,94	2,12	2,30	2,47	2,65	2,83	2,83	2,83	2,83	2,83	2,83	2,83	2,83
2,25	3,38	1,88	2,06	2,25	2,44	2,63	2,81	3,00	3,19	3,38	3,38	3,38	3,38	3,38	3,38	3,38
2,50	3,95	2,17	2,37	2,57	2,77	2,96	3,16	3,36	3,56	3,76	3,95	3,95	3,95	3,95	3,95	3,95
2,75	4,56	2,49	2,69	2,90	3,11	3,32	3,52	3,73	3,94	4,15	4,35	4,56	4,56	4,56	4,56	4,56
3,00	5,20	2,81	3,03	3,25	3,46	3,68	3,90	4,11	4,33	4,55	4,76	4,98	5,20	5,20	5,20	5,20
3,25	5,86	3,15	3,38	3,61	3,83	4,06	4,28	4,51	4,73	4,96	5,18	5,41	5,63	5,86	5,86	5,86
3,50	6,55	3,51	3,74	3,98	4,21	4,44	4,68	4,91	5,14	5,38	5,61	5,85	6,08	6,31	6,55	6,55
3,75	7,26	3,87	4,12	4,36	4,60	4,84	5,08	5,33	5,57	5,81	6,05	6,29	6,54	6,78	7,02	7,26
4,00	8,00	4,25	4,50	4,75	5,00	5,25	5,50	5,75	6,00	6,25	6,50	6,75	7,00	7,25	7,50	7,75
4,25	8,76	4,64	4,90	5,15	5,41	5,67	5,93	6,18	6,44	6,70	6,96	7,22	7,47	7,73	7,99	8,25
4,50	9,55	5,04	5,30	5,57	5,83	6,10	6,36	6,63	6,89	7,16	7,42	7,69	7,95	8,22	8,49	8,75
4,75	10,35	5,45	5,72	5,99	6,27	6,54	6,81	7,08	7,36	7,63	7,90	8,17	8,45	8,72	8,99	9,26
5,00	11,18	5,87	6,15	6,43	6,71	6,99	7,27	7,55	7,83	8,11	8,39	8,66	8,94	9,22	9,50	9,78
5,25	12,03	6,30	6,59	6,87	7,16	7,45	7,73	8,02	8,31	8,59	8,88	9,17	9,45	9,74	10,02	10,31
5,50	12,90	6,74	7,04	7,33	7,62	7,92	8,21	8,50	8,79	9,09	9,38	9,67	9,97	10,26	10,55	10,85

a) The anchor spacing and the edge distance shall not be smaller than the minimum anchor spacing s_{min} and the minimum edge distance c_{min} .

Combined tension and shear loading

The following equations must be satisfied

$$\beta_N \leq 1$$

$$\beta_V \leq 1$$

$$\beta_N + \beta_V \leq 1,2 \text{ or } \beta_N^\alpha + \beta_V^\alpha \leq 1$$

With

$$\beta_N = N_{Sd} / N_{Rd} \text{ and}$$

$$\beta_V = V_{Sd} / V_{Rd}$$

$N_{Sd} (V_{Sd})$ = tension (shear)
design action

$N_{Rd} (V_{Rd})$ = tension (shear)
design resistance

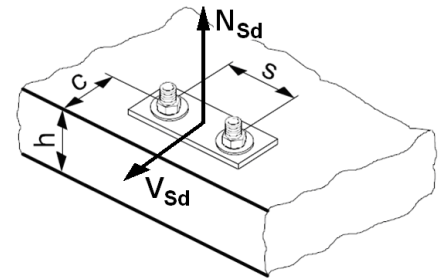

Annex C of ETAG 001

$\alpha = 2,0$ if N_{Rd} and V_{Rd} are governed by steel failure





$\alpha = 1,5$ for all other failure modes

Simplified design method

Failure mode is not considered for the simplified method

$\alpha = 1,5$ for all failure modes (leading to conservative results)

Hilti HIT-RE 500 mortar with HIT-V / HAS rod

Injection mortar system		Benefits
	Hilti HIT-RE 500 330 ml foil pack (also available as 500 ml and 1400 ml foil pack)	<ul style="list-style-type: none"> - SAFEset technology: drilling and borehole cleaning in one step with Hilti hollow drill bit - suitable for non-cracked concrete C 20/25 to C 50/60 - high loading capacity - suitable for dry and water saturated concrete - under water application - large diameter applications - high corrosion resistant - long working time at elevated temperatures - odourless epoxy - embedment depth range: from 40 ... 160 mm for M8 to 120 ... 600 mm for M30
	Statik mixer	
	HAS rod	
	HAS-E rod	
	HIT-V rod	



Concrete

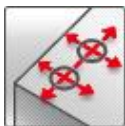

Small edge distance and spacing

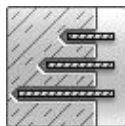

Variable embedment depth



Fire resistance

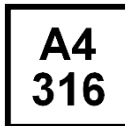

Corrosion resistance



High corrosion resistance



Diamond drilled holes

SAFEset

Hilti **SAFEset** technology with hollow drill bit



European Technical Approval



CE conformity



PROFIS Anchor design software

Approvals / certificates

Description	Authority / Laboratory	No. / date of issue
European technical approval a)	DIBt, Berlin	ETA-04/0027 / 2013-06-26
Fire test report	IBMB, Braunschweig	UB 3565 / 4595 / 2006-10-29 UB 3588 / 4825 / 2005-11-15
Assessment report (fire)	warringtonfire	WF 327804/B / 2013-07-10

a) All data given in this section according ETA-04/0027, issue 2013-06-26.

Basic loading data (for a single anchor)

All data in this section applies to

For details see Simplified design method

- Correct setting (See setting instruction)
- No edge distance and spacing influence
- Steel failure
- Base material thickness, as specified in the table
- One typical embedment depth, as specified in the table
- One anchor material, as specified in the tables
- Concrete C 20/25, $f_{ck,cube} = 25 \text{ N/mm}^2$
- Temperature range I
(min. base material temperature -40°C , max. long term/short term base material temperature: $+24^\circ\text{C}/40^\circ\text{C}$)
- Installation temperature range $+5^\circ\text{C}$ to $+40^\circ\text{C}$

Embedment depth ^{a)} and base material thickness for the basic loading data.

Mean ultimate resistance, characteristic resistance, design resistance, recommended loads.

Anchor size	M8	M10	M12	M16	M20	M24	M27	M30	M33	M36	M39
Typical embedment depth [mm]	80	90	110	125	170	210	240	270	300	330	360
Base material thickness [mm]	110	120	140	165	220	270	300	340	380	410	450

a) The allowed range of embedment depth is shown in the setting details. The corresponding load values can be calculated according to the simplified design method.

For hammer drilled holes and hollow drill bit:

Mean ultimate resistance: concrete C 20/25 – $f_{ck,cube} = 25 \text{ N/mm}^2$, anchor HIT-V 5.8

			ETA-04/0027, issue 2013-06-26 for hammer drilling and hollow drill bit							Additional Hilti technical data			
Anchor size			M8	M10	M12	M16	M20	M24	M27	M30	M33	M36	M39
Tensile $N_{Ru,m}$	HIT-V 5.8	[kN]	18,9	30,5	44,1	83,0	129,2	185,9	241,5	295,1	364,4	428,9	459,9
Shear $V_{Ru,m}$	HIT-V 5.8	[kN]	9,5	15,8	22,1	41,0	64,1	92,4	120,8	147,0	182,2	214,5	256,2

Characteristic resistance: concrete C 20/25 – $f_{ck,cube} = 25 \text{ N/mm}^2$, anchor HIT-V 5.8

			ETA-04/0027, issue 2013-06-26 for hammer drilling and hollow drill bit							Additional Hilti technical data			
Anchor size			M8	M10	M12	M16	M20	M24	M27	M30	M33	M36	M39
Tensile N_{Rk}	HIT-V 5.8	[kN]	18,0	29,0	42,0	70,6	111,9	153,7	187,8	224,0	262,4	302,7	344,9
Shear V_{Rk}	HIT-V 5.8	[kN]	9,0	15,0	21,0	39,0	61,0	88,0	115,0	140,0	173,5	204,3	244,0

Design resistance: concrete C 20/25 – $f_{ck,cube} = 25 \text{ N/mm}^2$, anchor HIT-V 5.8

			ETA-04/0027, issue 2013-06-26 for hammer drilling and hollow drill bit							Additional Hilti technical data			
Anchor size			M8	M10	M12	M16	M20	M24	M27	M30	M33	M36	M39
Tensile N_{Rd}	HIT-V 5.8	[kN]	12,0	19,3	27,7	33,6	53,3	73,2	89,4	106,7	125,0	144,2	164,3
Shear V_{Rd}	HIT-V 5.8	[kN]	7,2	12,0	16,8	31,2	48,8	70,4	92,0	112,0	138,8	163,4	195,2

Recommended loads ^{a)}: concrete C 20/25 – $f_{ck,cube} = 25 \text{ N/mm}^2$, anchor HIT-V 5.8

			ETA-04/0027, issue 2013-06-26 for hammer drilling and hollow drill bit							Additional Hilti technical data			
Anchor size			M8	M10	M12	M16	M20	M24	M27	M30	M33	M36	M39
Tensile N_{rec}	HIT-V 5.8	[kN]	8,6	13,8	19,8	24,0	38,1	52,3	63,9	76,2	89,3	103,0	117,3
Shear V_{rec}	HIT-V 5.8	[kN]	5,1	8,6	12,0	22,3	34,9	50,3	65,7	80,0	99,1	116,7	139,4

a) With overall partial safety factor for action $\gamma = 1,4$. The partial safety factors for action depend on the type of loading and shall be taken from national regulations.

For diamond drilling:

Mean ultimate resistance: concrete C 20/25 – $f_{ck,cube} = 25 \text{ N/mm}^2$, anchor HIT-V 5.8

		ETA-04/0027, issue 2013-06-26 for diamond drilling							
Anchor size		M8	M10	M12	M16	M20	M24	M27	M30
Tensile $N_{Ru,m}$	HIT-V 5.8 [kN]	18,9	30,5	44,1	83,0	129,2	185,9	241,5	287,2
Shear $V_{Ru,m}$	HIT-V 5.8 [kN]	9,5	15,8	22,1	41,0	64,1	92,4	120,8	147,0

Characteristic resistance: concrete C 20/25 – $f_{ck,cube} = 25 \text{ N/mm}^2$, anchor HIT-V 5.8

		ETA-04/0027, issue 2013-06-26 for diamond drilling							
Anchor size		M8	M10	M12	M16	M20	M24	M27	M30
Tensile N_{Rk}	HIT-V 5.8 [kN]	18,0	29,0	42,0	70,6	111,9	153,7	183,2	216,3
Shear V_{Rk}	HIT-V 5.8 [kN]	9,0	15,0	21,0	39,0	61,0	88,0	115,0	140,0

Design resistance: concrete C 20/25 – $f_{ck,cube} = 25 \text{ N/mm}^2$, anchor HIT-V 5.8

		ETA-04/0027, issue 2013-06-26 for diamond drilling							
Anchor size		M8	M10	M12	M16	M20	M24	M27	M30
Tensile N_{Rd}	HIT-V 5.8 [kN]	12,0	19,3	28,0	33,6	53,3	73,2	87,3	103,0
Shear V_{Rd}	HIT-V 5.8 [kN]	7,2	12,0	16,8	31,2	48,8	70,4	92,0	112,0

Recommended loads ^{a)}: concrete C 20/25 – $f_{ck,cube} = 25 \text{ N/mm}^2$, anchor HIT-V 5.8

		ETA-04/0027, issue 2013-06-26 for diamond drilling							
Anchor size		M8	M10	M12	M16	M20	M24	M27	M30
Tensile N_{rec}	HIT-V 5.8 [kN]	8,6	13,8	20,0	24,0	38,1	52,3	62,3	73,6
Shear V_{rec}	HIT-V 5.8 [kN]	5,1	8,6	12,0	22,3	34,9	50,3	65,7	80,0

a) With overall partial safety factor for action $\gamma = 1,4$. The partial safety factors for action depend on the type of loading and shall be taken from national regulations.

Service temperature range

Hilti HIT-RE 500 injection mortar may be applied in the temperature ranges given below. An elevated base material temperature may lead to a reduction of the design bond resistance.

Temperature range	Base material temperature	Maximum long term base material temperature	Maximum short term base material temperature
Temperature range I	-40 °C to +40 °C	+24 °C	+40 °C
Temperature range II	-40 °C to +58 °C	+35 °C	+58 °C
Temperature range III	-40 °C to +70 °C	+43 °C	+70 °C

Max short term base material temperature

Short-term elevated base material temperatures are those that occur over brief intervals, e.g. as a result of diurnal cycling.

Max long term base material temperature

Long-term elevated base material temperatures are roughly constant over significant periods of time.

Materials

Mechanical properties of HIT-V / HAS

Anchor size			Data according ETA-04/0027, issue 2013-06-26								Additional Hilti technical data		
			M8	M10	M12	M16	M20	M24	M27	M30	M33	M36	M39
Nominal tensile strength f_{uk}	HIT-V/HAS 5.8 [N/mm ²]		500	500	500	500	500	500	500	500	500	500	500
	HIT-V/HAS 8.8 [N/mm ²]		800	800	800	800	800	800	800	800	800	800	800
	HIT-V/HAS -R [N/mm ²]		700	700	700	700	700	700	500	500	500	500	500
	HIT-V/HAS -HCR [N/mm ²]		800	800	800	800	800	700	700	700	500	500	500
Yield strength f_{yk}	HIT-V/HAS 5.8 [N/mm ²]		400	400	400	400	400	400	400	400	400	400	400
	HIT-V/HAS 8.8 [N/mm ²]		640	640	640	640	640	640	640	640	640	640	640
	HIT-V/HAS -R [N/mm ²]		450	450	450	450	450	450	210	210	210	210	210
	HIT-V/HAS -HCR [N/mm ²]		600	600	600	600	600	400	400	400	250	250	250
Stressed cross-section A_s	HAS [mm ²]		32,8	52,3	76,2	144	225	324	427	519	647	759	913
	HIT-V [mm ²]		36,6	58,0	84,3	157	245	353	459	561	694	817	976
Moment of resistance W	HAS [mm ³]		27,0	54,1	93,8	244	474	809	1274	1706	2321	2949	3891
	HIT-V [mm ³]		31,2	62,3	109	277	541	935	1387	1874	2579	3294	4301

Material quality

Part	Material
Threaded rod HIT-V(F), HAS 5.8 M8 – M24	Strength class 5.8, A ₅ > 8% ductile steel galvanized ≥ 5 µm, (F) hot dipped galvanized ≥ 45 µm,
Threaded rod HIT-V(F), HAS 8.8 M27 – M39	Strength class 8.8, A ₅ > 8% ductile steel galvanized ≥ 5 µm, (F) hot dipped galvanized ≥ 45 µm,
Threaded rod HIT-V-R, HAS-R	Stainless steel grade A4, A ₅ > 8% ductile strength class 70 for ≤ M24 and class 50 for M27 to M30, 1.4401; 1.4404; 1.4578; 1.4571; 1.4439; 1.4362
Threaded rod HIT-V-HCR, HAS-HCR	High corrosion resistant steel, 1.4529; 1.4565 strength ≤ M20: R _m = 800 N/mm ² , R _{p0.2} = 640 N/mm ² , A ₅ > 8% ductile M24 to M30: R _m = 700 N/mm ² , R _{p0.2} = 400 N/mm ² , A ₅ > 8% ductile
Washer ISO 7089	Steel galvanized, hot dipped galvanized
	Stainless steel, 1.4401; 1.4404; 1.4578; 1.4571; 1.4439; 1.4362
	High corrosion resistant steel, 1.4529; 1.4565
Nut EN ISO 4032	Strength class 8, steel galvanized ≥ 5 µm, hot dipped galvanized ≥ 45 µm,
	Strength class 70, stainless steel grade A4, 1.4401; 1.4404; 1.4578; 1.4571; 1.4439; 1.4362
	Strength class 70, high corrosion resistant steel, 1.4529; 1.4565

Anchor dimensions

Anchor size	M8	M10	M12	M16	M20	M24	M27	M30	M33	M36	M39
Anchor rod HAS, HAS-E, HAS-R, HAS-ER HAS-HCR	M8x80	M10x90	M12x110	M16x125	M20x170	M24x210	M27x240	M30x270	M33x300	M36x330	M39x360
Anchor embedment depth [mm]	80	90	110	125	170	210	240	270	300	330	360
Anchor rod HIT-V, HIT-V-R, HIT-V-HCR	Anchor rods HIT-V (-R / -HCR) are available in variable length										

Setting

installation equipment

Anchor size	M8	M10	M12	M16	M20	M24	M27	M30
Rotary hammer	TE2 – TE16				TE40 – TE70			
Other tools	compressed air gun or blow out pump, set of cleaning brushes, dispenser							
Additional Hilti recommended tools	DD EC-1, DD 100 ... DD xxx ^{a)}							

a) For anchors in diamond drilled holes load values for combined pull-out and concrete cone resistance have to be reduced (see section “Setting instruction”)

Setting instruction

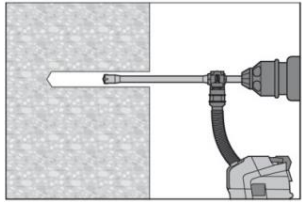
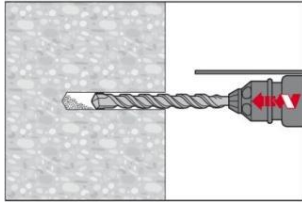
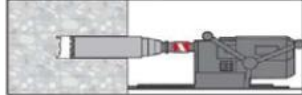
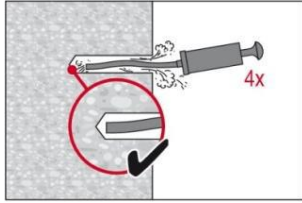
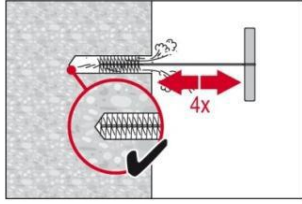
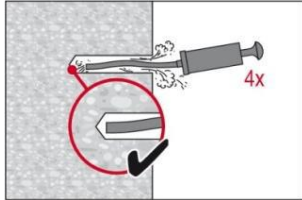
Bore hole drilling	
a) Hilti hollow drill bit	(for dry and wet concrete only)
	Drill hole to the required embedment depth with an appropriately sized Hilti TE-CD or TE-YD hollow drill bit with Hilti vacuum attachment. This drilling system removes the dust and cleans the bore hole during drilling when used in accordance with the user's manual. After drilling is complete, proceed to the "injection preparation" step in the instructions for use.
b) Hammer drilling	(dry or wet concrete and installation in flooded holes (no sea water))
	Drill Hole to the required embedment depth with a hammer drill set in rotation-hammer mode using an appropriately sized carbide drill bit.
c) Diamond coring	(for dry and wet concrete only)
	Diamond coring is permissible when diamond core drilling machine and the corresponding core bit are used.
Bore hole cleaning Just before setting an anchor, the bore hole must be free of dust and debris.	
a) Manual Cleaning (MC) non-cracked concrete only for bore hole diameters $d_0 \leq 20\text{mm}$ and bore hole depth $h_0 \leq 20d$ or $h_0 \leq 250\text{ mm}$ (d = diameter of element)	
	The Hilti manual pump may be used for blowing out bore holes up to diameters $d_0 \leq 20\text{ mm}$ and embedment depths up to $h_{ef} \leq 10d$. Blow out at least 4 times from the back of the bore hole until return air stream is free of noticeable dust
	Brush 4 times with the specified brush size (brush diameter \geq bore hole) by inserting the steel brush Hilti HIT-RB to the back of the hole (if needed with extension) in a twisting motion and removing it. The brush must produce natural resistance as it enters the bore hole - if not the brush is too small and must be replaced with the proper brush diameter.
	Blow out again with manual pump at least 4 times until return air stream is free of noticeable dust.

b) Compressed air cleaning (CAC)

for all bore hole diameters d_0 and all bore hole depth h_0

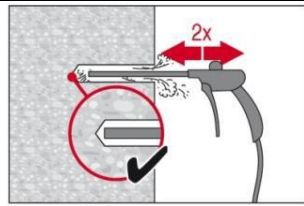

Blow 2 times from the back of the hole (if needed with nozzle extension) over the hole length with oil-free compressed air (min. 6 bar at 6 m³/h) until return air stream is free of noticeable dust.

Bore hole diameter ≥ 32 mm the compressor must supply a minimum air flow of 140 m³/hour.

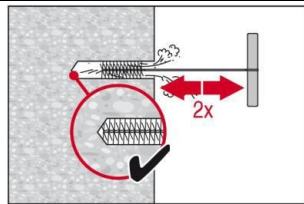

Brush 2 times with the specified brush size by inserting the steel brush Hilti HIT-RB to the back of the hole (if needed with extension) in a twisting motion and removing it.

The brush must produce natural resistance as it enters the bore hole - if not the brush is too small and must be replaced with the proper brush diameter.

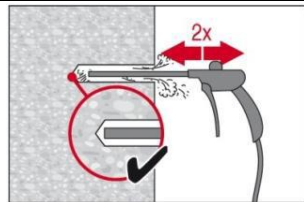

Blow again with compressed air 2 times until return air stream is free of noticeable dust.

c) Cleaning for under water

for all bore hole diameters d_0 and all bore hole depth h_0

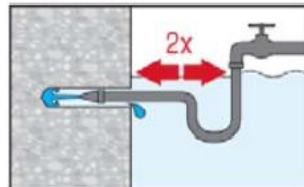

Flush 2 times the hole by inserting a water hose (water-line pressure) to the back of the hole until water runs clear.

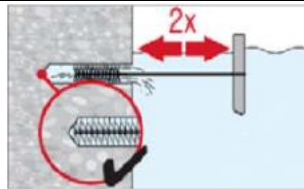

Brush 2 times with the specified brush size by inserting the steel brush Hilti HIT-RB to the back of the hole (if needed with extension) in a twisting motion and removing it.

The brush must produce natural resistance as it enters the bore hole - if not the brush is too small and must be replaced with the proper brush diameter.

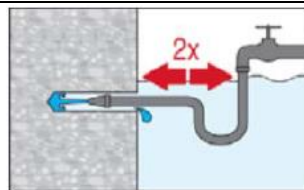

Flush again 2 times the hole by inserting a water hose (water-line pressure) to the back of the hole until water runs clear.

d) Cleaning of hammer drilled holes and diamond cored holes

for all bore hole diameters d_0 and all bore hole depth h_0

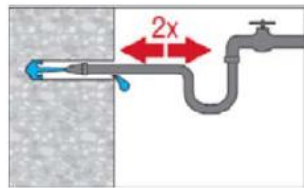

Flush 2 times the hole by inserting a water hose (water-line pressure) to the back of the hole until water runs clear.

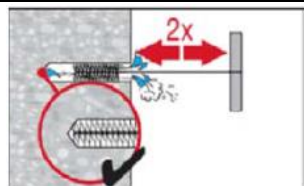

Brush 2 times with the specified brush size by inserting the steel brush Hilti HIT-RB to the back of the hole (if needed with extension) in a twisting motion and removing it.

The brush must produce natural resistance as it enters the bore hole - if not the brush is too small and must be replaced with the proper brush diameter.

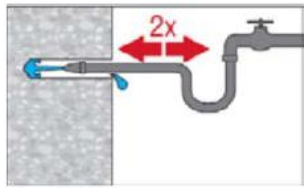

Flush again 2 times the hole by inserting a water hose (water-line pressure) to the back of the hole until water runs clear.

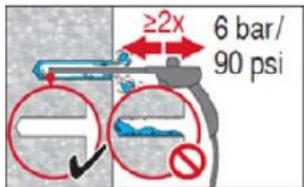

Blow 2 times from the back of the hole (if needed with nozzle extension) over the hole length with oil-free compressed air (min. 6 bar at 6 m³/h) until return air stream is free of noticeable dust and water.

Bore hole diameter ≥ 32 mm the compressor must supply a minimum air flow of 140 m³/hour.

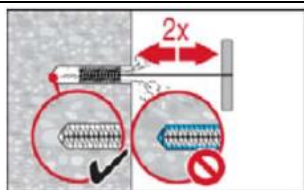

Brush 2 times with the specified brush size by inserting the steel brush Hilti HIT-RB to the back of the hole (if needed with extension) in a twisting motion and removing it.

The brush must produce natural resistance as it enters the bore hole - if not the brush is too small and must be replaced with the proper brush diameter.

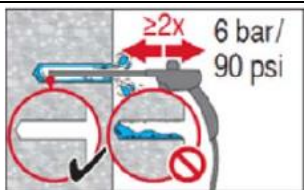

Blow again with compressed air 2 times until return air stream is free of noticeable dust and water.

Injection preparation

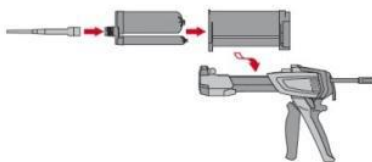

Tightly attach new Hilti mixing nozzle HIT-RE-M to foil pack manifold (snug fit). Do not modify the mixing nozzle. Observe the instruction for use of the dispenser and mortar.

Check foil pack holder for proper function. Do not use damaged foil packs / holders.

Insert foil pack into foil pack holder and put holder into HIT-dispenser.

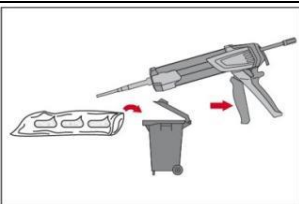

The foil pack opens automatically as dispensing is initiated. Discard initial adhesive. Depending on the size of the foil pack an initial amount of adhesive has to be discarded.

Discard quantities are:

2 strokes for 330 ml foil pack,

3 strokes for 500 ml foil pack,

65 ml for 1400 ml foil pack.

Inject adhesive from the back of the borehole without forming air voids

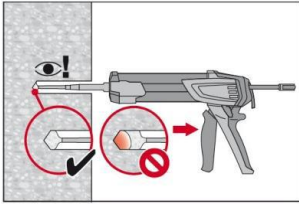

Inject the adhesive starting at the back of the hole, slowly withdrawing the mixer with each trigger pull. Fill holes approximately 2/3 full. It is required that the annular gap between the anchor and the concrete is completely filled with adhesive along the embedment length.

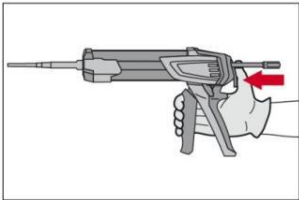

After injection is completed, depressurize the dispenser by pressing the release trigger. This will prevent further adhesive discharge from the mixer.

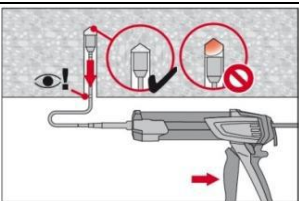

Overhead installation and/or installation with embedment depth $h_{ef} > 250\text{mm}$.

For overhead installation the injection is only possible with the aid of extensions and piston plugs. Assemble HIT-RE-M mixer, extension(s) and appropriately sized piston plug HIT-SZ. Insert piston plug to back of the hole and inject adhesive. During injection the piston plug will be naturally extruded out of the bore hole by the adhesive pressure.

Under water application: fill borehole completely with mortar.

Setting the element

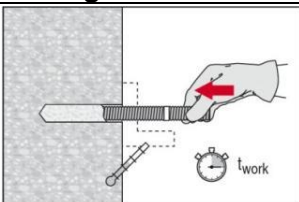

Before use, verify that the element is dry and free of oil and other contaminants. Mark and set element to the required embedment depth until working time t_{work} has elapsed.

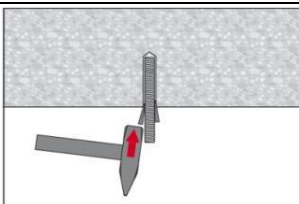

For overhead installation use piston plugs and fix embedded parts with e.g. wedges HIT-OHW.

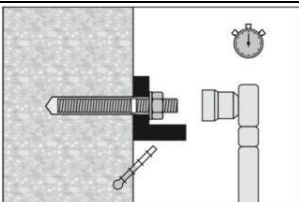

Loading the anchor:
After required curing time t_{cure} the anchor can be loaded. The applied installation torque shall not exceed T_{max} .

For detailed information on installation see instruction for use given with the package of the product.

Curing time for general conditions

Data according ETA-04/0027, issue 2013-06-26		
Temperature of the base material	Working time in which anchor can be inserted and adjusted t_{gel}	Curing time before anchor can be fully loaded t_{cure}
40 °C	12 min	4 h
30 °C to 39 °C	12 min	8 h
20 °C to 29 °C	20 min	12 h
15 °C to 19 °C	30 min	24 h
10 °C to 14 °C	90 min	48 h
5 °C to 9 °C	120 min	72 h

For dry concrete curing times may be reduced according to the following table.

For installation temperatures below +5 °C all load values have to be reduced according to the load reduction factors given below.

Curing time for dry concrete

Additional Hilti technical data			
Temperature of the base material	Working time in which anchor can be inserted and adjusted t_{gel}	Reduced curing time before anchor can be fully loaded $t_{cure,dry}$	Load reduction factor
40 °C	12 min	4 h	1
30 °C	12 min	8 h	1
20 °C	20 min	12 h	1
15 °C	30 min	18 h	1
10 °C	90 min	24 h	1
5 °C	120 min	36 h	1
0 °C	3 h	50 h	0,7
-5 °C	4 h	72 h	0,6

Setting details

			Data according ETA-04/0027, issue 2013-06-26							Additional Hilti technical data			
Anchor size			M8	M10	M12	M16	M20	M24	M27	M30	M33	M36	M39
Nominal diameter of drill bit	d_0	[mm]	10	12	14	18	24	28	30	35	37	40	42
Effective anchorage and drill hole depth range ^{a)}	$h_{ef,min}$	[mm]	40	40	48	64	80	96	108	120	132	144	156
	$h_{ef,max}$	[mm]	160	200	240	320	400	480	540	600	660	720	780
Minimum base material thickness	h_{min}	[mm]	$h_{ef} + 30 \text{ mm}$ $\geq 100 \text{ mm}$				$h_{ef} + 2 d_0$						
Diameter of clearance hole in the fixture	d_f	[mm]	9	12	14	18	22	26	30	33	36	39	42
Minimum spacing	s_{min}	[mm]	40	50	60	80	100	120	135	150	165	180	195
Minimum edge distance	c_{min}	[mm]	40	50	60	80	100	120	135	150	165	180	195
Critical spacing for splitting failure	$s_{cr,sp}$		$2 c_{cr,sp}$										
Critical edge distance for splitting failure ^{b)}	$c_{cr,sp}$	[mm]	$1,0 \cdot h_{ef}$ for $h / h_{ef} \geq 2,0$										
			$4,6 h_{ef} - 1,8 h$ for $2,0 > h / h_{ef} > 1,3$										
			$2,26 h_{ef}$ for $h / h_{ef} \leq 1,3$										
Critical spacing for concrete cone failure	$s_{cr,N}$		$2 c_{cr,N}$										
Critical edge distance for concrete cone failure ^{c)}	$c_{cr,N}$		$1,5 h_{ef}$										
Torque moment ^{d)}	T_{max}	[Nm]	10	20	40	80	150	200	270	300	330	360	390

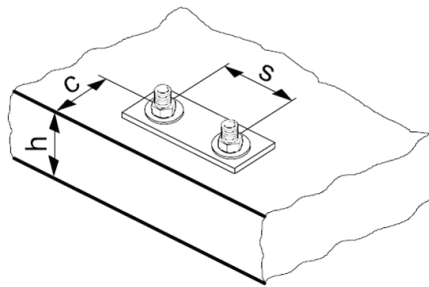

For spacing (edge distance) smaller than critical spacing (critical edge distance) the design loads have to be reduced.

- a) $h_{ef,min} \leq h_{ef} \leq h_{ef,max}$ (h_{ef} : embedment depth)
- b) h : base material thickness ($h \geq h_{min}$)
- c) The critical edge distance for concrete cone failure depends on the embedment depth h_{ef} and the design bond resistance. The simplified formula given in this table is on the safe side.
- d) This is the maximum recommended torque moment to avoid splitting failure during installation for anchors with minimum spacing and/or edge distance.

Simplified design method

Simplified version of the design method according ETAG 001, TR 029. Design resistance according data given in ETA-04/0027, issue 2009-05-20.

- Influence of concrete strength
- Influence of edge distance
- Influence of spacing
- Valid for a group of two anchors. (The method may also be applied for anchor groups with more than two anchors or more than one edge distance. The influencing factors must then be considered for each edge distance and spacing. The calculated design loads are then on the save side: They will be lower than the exact values according ETAG 001, TR 029. To avoid this, it is recommended to use the anchor design software PROFIS anchor)

The design method is based on the following simplification:

- No different loads are acting on individual anchors (no eccentricity)

The values are valid for one anchor.

For more complex fastening applications please use the anchor design software PROFIS Anchor.

Tension loading

The design tensile resistance is the lower value of

- Steel resistance: $N_{Rd,s}$
- Combined pull-out and concrete cone resistance:
 $N_{Rd,p} = N_{Rd,p}^0 \cdot f_{B,p} \cdot f_{1,N} \cdot f_{2,N} \cdot f_{3,N} \cdot f_{h,p} \cdot f_{re,N}$
- Concrete cone resistance: $N_{Rd,c} = N_{Rd,c}^0 \cdot f_B \cdot f_{1,N} \cdot f_{2,N} \cdot f_{3,N} \cdot f_{h,N} \cdot f_{re,N}$
- Concrete splitting resistance (only non-cracked concrete):
 $N_{Rd,sp} = N_{Rd,c}^0 \cdot f_B \cdot f_{1,sp} \cdot f_{2,sp} \cdot f_{3,sp} \cdot f_{h,N} \cdot f_{re,N}$

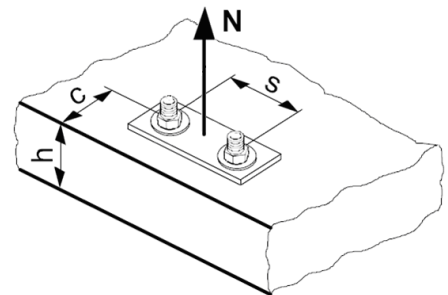

Basic design tensile resistance

Design steel resistance $N_{Rd,s}$

		Data according ETA-04/0027, issue 2013-06-26							Additional Hilti technical data			
Anchor size		M8	M10	M12	M16	M20	M24	M27	M30	M33	M36	M39
$N_{Rd,s}$	HAS 5.8 [kN]	11,3	17,3	25,3	48,0	74,7	106,7	-	-	-	-	-
	HIT-V 5.8 [kN]	12,0	19,3	28,0	52,7	82,0	118,0	153,3	187,3	231,3	272,3	325,3
	HAS 8.8 [kN]	-	-	-	-	-	-	231,3	281,3	345,1	404,8	486,9
	HIT-V 8.8 [kN]	19,3	30,7	44,7	84,0	130,7	188,0	244,7	299,3	370,1	435,7	520,5
	HAS (-E)-R [kN]	12,3	19,8	28,3	54,0	84,0	119,8	75,9	92,0	113,2	132,8	159,8
	HIT-V-R [kN]	13,9	21,9	31,6	58,8	92,0	132,1	80,4	98,3	122,6	144,3	172,4
	HAS (-E)-HCR [kN]	18,0	28,0	40,7	76,7	120,0	106,7	144,8	175,7	134,8	158,1	190,2
	HIT-V-HCR [kN]	19,3	30,7	44,7	84,0	130,7	117,6	152,9	187,1	144,6	170,2	203,3

Design combined pull-out and concrete cone resistance for anchors ^{a)}

$$N_{Rd,p} = N_{Rd,p}^0 \cdot f_{B,p} \cdot f_{1,N} \cdot f_{2,N} \cdot f_{3,N} \cdot f_{h,p} \cdot f_{re,N}$$

			Data according ETA-04/0027, issue 2013-06-26							Additional Hilti technical data			
Anchor size			M8	M10	M12	M16	M20	M24	M27	M30	M33	M36	M39
Typical embedment depth $h_{ef,typ}$ [mm]			80	90	110	125	170	210	240	270	300	330	360
Hammer drilling + Hilti hollow drill bit	$N_{Rd,p}^0$ [kN]	Temp range I	15.3	21.5	31.6	44.9	76.3	105.6	135.7	157.5	171,0	203,3	232,9
	$N_{Rd,p}^0$ [kN]	Temp range II	12.4	17.5	25.7	35.9	61.0	82.9	106.6	133.3	136,8	162,6	186,3
	$N_{Rd,p}^0$ [kN]	Temp range III	7.7	10.8	15.8	22.4	35.6	52.8	63.0	78.8	82,1	97,6	111,8
Diamond coring	$N_{Rd,p}^0$ [kN]	Temp range I	14.5	20.4	29.9	35.9	56.0	75.4	87.2	103.0	-	-	-
	$N_{Rd,p}^0$ [kN]	Temp range II	12.3	17.3	25.3	28.4	45.8	60.3	67.9	78.8	-	-	-
	$N_{Rd,p}^0$ [kN]	Temp range III	7.3	10.2	15.0	16.5	25.4	33.9	43.6	48.5	-	-	-

a) Additional Hilti technical data (not part of ETA-04/0027, issue 2013-06-26):

The design values for combined pull-out and concrete cone resistance may be increased by 20 % for anchor installation in dry concrete (concrete not in contact with water before/during installation and curing).

Design concrete cone resistance ^{a)} $N_{Rd,c} = N_{Rd,c}^0 \cdot f_B \cdot f_{1,N} \cdot f_{2,N} \cdot f_{3,N} \cdot f_{h,N} \cdot f_{re,N}$

Design splitting resistance $N_{Rd,sp} = N_{Rd,c}^0 \cdot f_B \cdot f_{1,sp} \cdot f_{2,sp} \cdot f_{3,sp} \cdot f_{h,N} \cdot f_{re,N}$

			Data according ETA-04/0027, issue 2013-06-26							Additional Hilti technical data			
Anchor size			M8	M10	M12	M16	M20	M24	M27	M30	M33	M36	M39
$N_{Rd,c}^0$ [kN]			17,2	20,5	27,7	33,6	53,3	73,2	89,4	106,7	125,0	144,2	164,3

a) Additional Hilti technical data (not part of ETA-04/0027, issue -2013-06-26):

The design values for concrete cone and splitting resistance may be increased by 20 % for anchor installation in dry concrete (concrete not in contact with water before/during installation and curing).

Influencing factors

Influence of concrete strength on combined pull-out and concrete cone resistance

Concrete strength designation (ENV 206)	C 20/25	C 25/30	C 30/37	C 35/45	C 40/50	C 45/55	C 50/60
$f_{B,p} = (f_{ck,cube}/25N/mm^2)^{0,1}$ ^{a)}	1	1,02	1,04	1,06	1,07	1,08	1,09

a) $f_{ck,cube}$ = concrete compressive strength, measured on cubes with 150 mm side length

Influence of embedment depth on combined pull-out and concrete cone resistance

$$f_{h,p} = h_{ef}/h_{ef,typ}$$

Influence of concrete strength on concrete cone resistance

Concrete strength designation (ENV 206)	C 20/25	C 25/30	C 30/37	C 35/45	C 40/50	C 45/55	C 50/60
$f_B = (f_{ck,cube}/25N/mm^2)^{1/2}$ ^{a)}	1	1,1	1,22	1,34	1,41	1,48	1,55

a) $f_{ck,cube}$ = concrete compressive strength, measured on cubes with 150 mm side length

Influence of edge distance ^{a)}

$c/c_{cr,N}$	0,1	0,2	0,3	0,4	0,5	0,6	0,7	0,8	0,9	1
$c/c_{cr,sp}$										
$f_{1,N} = 0,7 + 0,3 \cdot c/c_{cr,N}$	0,73	0,76	0,79	0,82	0,85	0,88	0,91	0,94	0,97	1
$f_{1,sp} = 0,7 + 0,3 \cdot c/c_{cr,sp}$										
$f_{2,N} = 0,5 \cdot (1 + c/c_{cr,N})$	0,55	0,60	0,65	0,70	0,75	0,80	0,85	0,90	0,95	1
$f_{2,sp} = 0,5 \cdot (1 + c/c_{cr,sp})$										

a) The edge distance shall not be smaller than the minimum edge distance c_{min} given in the table with the setting details. These influencing factors must be considered for every edge distance smaller than the critical edge distance.

Influence of anchor spacing ^{a)}

$s/s_{cr,N}$	0,1	0,2	0,3	0,4	0,5	0,6	0,7	0,8	0,9	1
$s/s_{cr,sp}$										
$f_{3,N} = 0,5 \cdot (1 + s/s_{cr,N})$	0,55	0,60	0,65	0,70	0,75	0,80	0,85	0,90	0,95	1
$f_{3,sp} = 0,5 \cdot (1 + s/s_{cr,sp})$										

a) The anchor spacing shall not be smaller than the minimum anchor spacing s_{min} given in the table with the setting details. This influencing factor must be considered for every anchor spacing.

Influence of embedment depth on concrete cone resistance

$$f_{h,N} = (h_{ef}/h_{ef,typ})^{1,5}$$

Influence of reinforcement

h_{ef} [mm]	40	50	60	70	80	90	≥ 100
$f_{re,N} = 0,5 + h_{ef}/200\text{mm} \leq 1$	0,7 ^{a)}	0,75 ^{a)}	0,8 ^{a)}	0,85 ^{a)}	0,9 ^{a)}	0,95 ^{a)}	1

a) This factor applies only for dense reinforcement. If in the area of anchorage there is reinforcement with a spacing ≥ 150 mm (any diameter) or with a diameter ≤ 10 mm and a spacing ≥ 100 mm, then a factor $f_{re} = 1$ may be applied.

Shear loading

The design shear resistance is the lower value of

- Steel resistance: $V_{Rd,s}$
- Concrete pryout resistance: $V_{Rd,cp} = k \cdot \text{lower value of } N_{Rd,p} \text{ and } N_{Rd,c}$
- Concrete edge resistance: $V_{Rd,c} = V_{Rd,c}^0 \cdot f_B \cdot f_{\beta} \cdot f_h \cdot f_4 \cdot f_{hef} \cdot f_c$

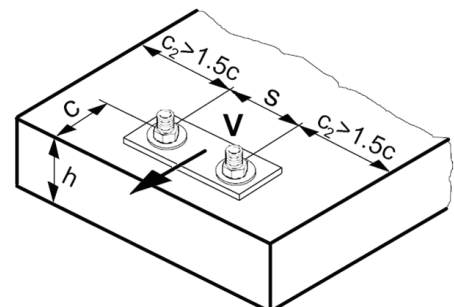

Basic design shear resistance

Design steel resistance $V_{Rd,s}$

			Data according ETA-04/0027, issue 2013-06-26							Additional Hilti technical data			
Anchor size			M8	M10	M12	M16	M20	M24	M27	M30	M33	M36	M39
$V_{Rd,s}$	HAS 5.8	[kN]	6,8	10,4	15,2	28,8	44,8	64,0	-	-	-	-	-
	HIT-V 5.8	[kN]	7,2	12,0	16,8	31,2	48,8	70,4	92,0	112,0	138,8	163,4	195,2
	HAS 8.8	[kN]	-	-	-	-	-	-	139,2	168,8	207,0	242,9	292,2
	HIT-V 8.8	[kN]	12,0	18,4	27,2	50,4	78,4	112,8	147,2	179,2	222,1	261,4	312,3
	HAS (-E)-R	[kN]	7,7	12,2	17,3	32,7	50,6	71,8	45,8	55,5	67,9	79,7	95,9
	HIT-V-R	[kN]	8,3	12,8	19,2	35,3	55,1	79,5	48,3	58,8	72,9	85,8	102,5
	HAS (-E)-HCR	[kN]	10,4	16,8	24,8	46,4	72,0	64,0	86,9	105,7	80,9	94,9	114,1
	HIT-V-HCR	[kN]	12,0	18,4	27,2	50,4	78,4	70,9	92,0	112,0	86,8	102,1	122,0

Design concrete pryout resistance $V_{Rd,cp}$ = lower value^{a)} of $k \cdot N_{Rd,p}$ and $k \cdot N_{Rd,c}$

$$k = 1 \text{ for } h_{ef} < 60 \text{ mm}$$

$$k = 2 \text{ for } h_{ef} \geq 60 \text{ mm}$$

- a) $N_{Rd,p}$: Design combined pull-out and concrete cone resistance
 $N_{Rd,c}$: Design concrete cone resistance

Design concrete edge resistance $V_{Rd,c} = V_{Rd,c}^0 \cdot f_B \cdot f_{\beta} \cdot f_h \cdot f_4 \cdot f_{hef} \cdot f_c$

Anchor size	M8	M10	M12	M16	M20	M24	M27	M30	M33	M36	M39
Non-cracked concrete											
$V_{Rd,c}^0$ [kN]	5,9	8,6	11,6	18,7	27,0	36,6	44,5	53,0	62,1	71,7	81,9

Influencing factors

Influence of concrete strength

Concrete strength designation (ENV 206)	C 20/25	C 25/30	C 30/37	C 35/45	C 40/50	C 45/55	C 50/60
$f_B = (f_{ck,cube}/25N/mm^2)^{1/2}$ a)	1	1,1	1,22	1,34	1,41	1,48	1,55

- a) $f_{ck,cube}$ = concrete compressive strength, measured on cubes with 150 mm side length

Influence of angle between load applied and the direction perpendicular to the free edge

Angle β	0°	10°	20°	30°	40°	50°	60°	70°	80°	≥ 90°
$f_{\beta} = \frac{1}{\sqrt{(\cos \alpha_v)^2 + \left(\frac{\sin \alpha_v}{2,5}\right)^2}}$	1	1,01	1,05	1,13	1,24	1,40	1,64	1,97	2,32	2,50

Influence of base material thickness

h/c	0,15	0,3	0,45	0,6	0,75	0,9	1,05	1,2	1,35	≥ 1,5
$f_h = \{h/(1,5 \cdot c)\}^{1/2} \leq 1$	0,32	0,45	0,55	0,63	0,71	0,77	0,84	0,89	0,95	1,00

Influence of anchor spacing and edge distance ^{a)} for concrete edge resistance: f_4
 $f_4 = (c/h_{ef})^{1,5} \cdot (1 + s / [3 \cdot c]) \cdot 0,5$

c/h _{ef}	Single anchor	Group of two anchors s/h _{ef}														
		0,75	1,50	2,25	3,00	3,75	4,50	5,25	6,00	6,75	7,50	8,25	9,00	9,75	10,50	11,25
0,50	0,35	0,27	0,35	0,35	0,35	0,35	0,35	0,35	0,35	0,35	0,35	0,35	0,35	0,35	0,35	0,35
0,75	0,65	0,43	0,54	0,65	0,65	0,65	0,65	0,65	0,65	0,65	0,65	0,65	0,65	0,65	0,65	0,65
1,00	1,00	0,63	0,75	0,88	1,00	1,00	1,00	1,00	1,00	1,00	1,00	1,00	1,00	1,00	1,00	1,00
1,25	1,40	0,84	0,98	1,12	1,26	1,40	1,40	1,40	1,40	1,40	1,40	1,40	1,40	1,40	1,40	1,40
1,50	1,84	1,07	1,22	1,38	1,53	1,68	1,84	1,84	1,84	1,84	1,84	1,84	1,84	1,84	1,84	1,84
1,75	2,32	1,32	1,49	1,65	1,82	1,98	2,15	2,32	2,32	2,32	2,32	2,32	2,32	2,32	2,32	2,32
2,00	2,83	1,59	1,77	1,94	2,12	2,30	2,47	2,65	2,83	2,83	2,83	2,83	2,83	2,83	2,83	2,83
2,25	3,38	1,88	2,06	2,25	2,44	2,63	2,81	3,00	3,19	3,38	3,38	3,38	3,38	3,38	3,38	3,38
2,50	3,95	2,17	2,37	2,57	2,77	2,96	3,16	3,36	3,56	3,76	3,95	3,95	3,95	3,95	3,95	3,95
2,75	4,56	2,49	2,69	2,90	3,11	3,32	3,52	3,73	3,94	4,15	4,35	4,56	4,56	4,56	4,56	4,56
3,00	5,20	2,81	3,03	3,25	3,46	3,68	3,90	4,11	4,33	4,55	4,76	4,98	5,20	5,20	5,20	5,20
3,25	5,86	3,15	3,38	3,61	3,83	4,06	4,28	4,51	4,73	4,96	5,18	5,41	5,63	5,86	5,86	5,86
3,50	6,55	3,51	3,74	3,98	4,21	4,44	4,68	4,91	5,14	5,38	5,61	5,85	6,08	6,31	6,55	6,55
3,75	7,26	3,87	4,12	4,36	4,60	4,84	5,08	5,33	5,57	5,81	6,05	6,29	6,54	6,78	7,02	7,26
4,00	8,00	4,25	4,50	4,75	5,00	5,25	5,50	5,75	6,00	6,25	6,50	6,75	7,00	7,25	7,50	7,75
4,25	8,76	4,64	4,90	5,15	5,41	5,67	5,93	6,18	6,44	6,70	6,96	7,22	7,47	7,73	7,99	8,25
4,50	9,55	5,04	5,30	5,57	5,83	6,10	6,36	6,63	6,89	7,16	7,42	7,69	7,95	8,22	8,49	8,75
4,75	10,35	5,45	5,72	5,99	6,27	6,54	6,81	7,08	7,36	7,63	7,90	8,17	8,45	8,72	8,99	9,26
5,00	11,18	5,87	6,15	6,43	6,71	6,99	7,27	7,55	7,83	8,11	8,39	8,66	8,94	9,22	9,50	9,78
5,25	12,03	6,30	6,59	6,87	7,16	7,45	7,73	8,02	8,31	8,59	8,88	9,17	9,45	9,74	10,02	10,31
5,50	12,90	6,74	7,04	7,33	7,62	7,92	8,21	8,50	8,79	9,09	9,38	9,67	9,97	10,26	10,55	10,85

a) The anchor spacing and the edge distance shall not be smaller than the minimum anchor spacing s_{min} and the minimum edge distance c_{min} .

Influence of embedment depth

h _{ef} /d	4	4,5	5	6	7	8	9	10	11
f _{hef} = 0,05 · (h _{ef} / d) ^{1,68}	0,51	0,63	0,75	1,01	1,31	1,64	2,00	2,39	2,81
h _{ef} /d	12	13	14	15	16	17	18	19	20
f _{hef} = 0,05 · (h _{ef} / d) ^{1,68}	3,25	3,72	4,21	4,73	5,27	5,84	6,42	7,04	7,67

Influence of edge distance ^{a)}

c/d	4	6	8	10	15	20	30	40
f _c = (d / c) ^{0,19}	0,77	0,71	0,67	0,65	0,60	0,57	0,52	0,50

a) The edge distance shall not be smaller than the minimum edge distance c_{min} .

Combined tension and shear loading for hammer drilling or hollow drill bit

For combined tension and shear loading see section "Anchor Design".

Precalculated values

Recommended loads can be calculated by dividing the design resistance by an overall partial safety factor for action $\gamma = 1,4$. The partial safety factors for action depend on the type of loading and shall be taken from national regulations.

Design resistance: concrete C 20/25 – $f_{ck,cube} = 25 \text{ N/mm}^2$, Temperature range I

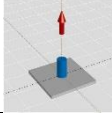
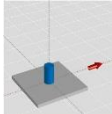
	Data according ETA-04/0027, issue 2013-06-26								Additional Hilti technical data		
Anchor size	M8	M10	M12	M16	M20	M24	M27	M30	M33	M36	M39
Embedment depth $h_{ef,1} =$ [mm]	48	60	72	96	120	144	162	180	198	216	234
Base material thickness $h_{min} =$ [mm]	100	100	102	132	168	200	222	250	272	296	324
Tensile N_{Rd}: single anchor, no edge effects											
 HIT-V 5.8 HIT-V 8.8 HIT-V-R HIT-V-HCR [kN]	8,0	11,2	14,7	22,6	31,6	41,6	49,6	58,1	67,0	76,3	86,1
Shear V_{Rd}: single anchor, no edge effects, without lever arm											
 HIT-V 5.8 [kN]	7,2	12,0	16,8	31,2	48,8	70,4	92,0	112,0	138,8	163,4	195,2
HIT-V 8.8 [kN]	11,2	18,4	27,2	50,4	78,4	112,8	138,8	162,6	187,6	213,8	241,0
HIT-V-R [kN]	8,3	12,8	19,2	35,3	55,1	79,5	48,3	58,8	72,9	85,8	102,5
HIT-V-HCR [kN]	11,2	18,4	27,2	50,4	78,4	70,9	92,0	112,0	86,8	102,1	122,0

Design resistance: concrete C 20/25 – $f_{ck,cube} = 25 \text{ N/mm}^2$, Temperature range I

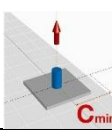
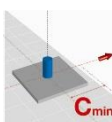
	Data according ETA-04/0027, issue 2013-06-26								Additional Hilti technical data		
Anchor size	M8	M10	M12	M16	M20	M24	M27	M30	M33	M36	M39
Embedment depth $h_{ef,1} =$ [mm]	48	60	72	96	120	144	162	180	198	216	234
Base material thickness $h_{min} =$ [mm]	100	100	102	132	168	200	222	250	272	296	324
Edge distance $c = c_{min} =$ [mm]	40	50	60	80	100	120	135	150	165	180	195
Tensile N_{Rd}: single anchor, min. edge distance ($c = c_{min}$)											
 HIT-V 5.8 HIT-V 8.8 HIT-V-R HIT-V-HCR [kN]	5,4	7,3	8,5	12,9	18,2	23,8	28,2	33,2	38,1	43,4	49,2
Shear V_{Rd}: single anchor, min. edge distance ($c = c_{min}$), without lever arm											
 HIT-V 5.8 [kN]	3,4	4,9	6,7	10,8	15,7	21,4	26,0	31,1	36,5	42,2	48,3
HIT-V 8.8 [kN]											
HIT-V-R [kN]											
HIT-V-HCR [kN]											

Design resistance: concrete C 20/25 – $f_{ck,cube} = 25 \text{ N/mm}^2$, Temperature range I
(load values are valid for single anchor)

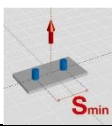
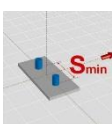
	Data according ETA-04/0027, issue 2013-06-26								Additional Hilti technical data		
Anchor size	M8	M10	M12	M16	M20	M24	M27	M30	M33	M36	M39
Embedment depth $h_{ef,1} =$ [mm]	48	60	72	96	120	144	162	180	198	216	234
Base material thickness $h_{min} =$ [mm]	100	100	102	132	168	200	222	250	272	296	324
Spacing $s = s_{min} =$ [mm]	40	50	60	80	100	120	135	150	165	180	195
Tensile N_{Rd}: double anchor, no edge effects, min. spacing ($s = s_{min}$)											
 HIT-V 5.8 HIT-V 8.8 HIT-V-R HIT-V-HCR [kN]	5,1	7,0	8,8	13,5	19,0	24,9	29,6	34,8	40,1	45,6	51,5
Shear V_{Rd}: double anchor, no edge effects, min. spacing ($s = s_{min}$), without lever arm											
 HIT-V 5.8 [kN]	7,2	12,0	16,8	31,2	48,8	70,4	88,7	103,9	119,9	136,6	154,0
HIT-V 8.8 [kN]	7,2	18,4	26,3	40,5	56,5	74,3	88,7	103,9	119,9	136,6	154,0
HIT-V-R [kN]	7,2	12,8	19,2	35,3	55,1	74,3	48,3	58,8	72,9	85,8	102,5
HIT-V-HCR [kN]	7,2	18,4	26,3	40,5	56,5	70,9	88,7	103,9	86,8	102,1	122,0

Design resistance: concrete C 20/25 – $f_{ck,cube} = 25 \text{ N/mm}^2$, Temperature range I

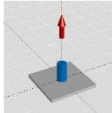
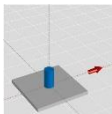
	Data according ETA-04/0027, issue 2013-06-26								Additional Hilti technical data		
Anchor size	M8	M10	M12	M16	M20	M24	M27	M30	M33	M36	M39
Embedment depth $h_{ef,typ} =$ [mm]	80	90	110	125	170	210	240	270	300	330	360
Base material thickness $h_{min} =$ [mm]	110	120	140	161	218	266	300	340	374	410	450
Tensile N_{Rd}: single anchor, no edge effects											
 HIT-V 5.8 [kN]	12,0	19,3	27,7	33,6	53,3	73,2	89,4	106,7	125,0	144,2	164,3
HIT-V 8.8 [kN]	15,3	20,5	27,7	33,6	53,3	73,2	89,4	106,7	125,0	144,2	164,3
HIT-V-R [kN]	13,9	20,5	27,7	33,6	53,3	73,2	80,4	98,3	122,6	144,2	164,3
HIT-V-HCR [kN]	15,3	20,5	27,7	33,6	53,3	73,2	89,4	106,7	125,0	144,2	164,3
Shear V_{Rd}: single anchor, no edge effects, without lever arm											
 HIT-V 5.8 [kN]	7,2	12,0	16,8	31,2	48,8	70,4	92,0	112,0	138,8	163,4	195,2
HIT-V 8.8 [kN]	12,0	18,4	27,2	50,4	78,4	112,8	147,2	179,2	222,1	261,4	312,3
HIT-V-R [kN]	8,3	12,8	19,2	35,3	55,1	79,5	48,3	58,8	72,9	85,8	102,5
HIT-V-HCR [kN]	12,0	18,4	27,2	50,4	78,4	70,9	92,0	112,0	86,8	102,1	122,0

Design resistance: concrete C 20/25 – $f_{ck,cube} = 25 \text{ N/mm}^2$, Temperature range I

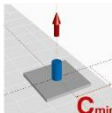
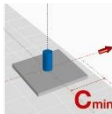
	Data according ETA-04/0027, issue 2013-06-26								Additional Hilti technical data		
Anchor size	M8	M10	M12	M16	M20	M24	M27	M30	M33	M36	M39
Embedment depth $h_{ef,typ} =$ [mm]	80	90	110	125	170	210	240	270	300	330	360
Base material thickness $h_{min} =$ [mm]	110	120	140	161	218	266	300	340	374	410	450
Edge distance $c = c_{min} =$ [mm]	40	50	60	80	100	120	135	150	165	180	195
Tensile N_{Rd}: single anchor, min. edge distance ($c = c_{min}$)											
 HIT-V 5.8 [kN]	8,2	10,0	13,3	16,9	26,1	35,6	43,3	51,4	60,0	69,1	78,6
HIT-V 8.8 [kN]											
HIT-V-R [kN]											
HIT-V-HCR [kN]											
Shear V_{Rd}: single anchor, min. edge distance ($c = c_{min}$), without lever arm											
 HIT-V 5.8 [kN]	3,7	5,3	7,3	11,5	17,2	23,6	29,0	34,8	41,1	47,8	54,9
HIT-V 8.8 [kN]											
HIT-V-R [kN]											
HIT-V-HCR [kN]											

**Design resistance: concrete C 20/25 – $f_{ck,cube} = 25 \text{ N/mm}^2$, Temperature range I
(load values are valid for single anchor)**

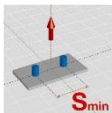
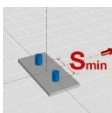
	Data according ETA-04/0027, issue 2013-06-26								Additional Hilti technical data		
Anchor size	M8	M10	M12	M16	M20	M24	M27	M30	M33	M36	M39
Embedment depth $h_{ef,typ} =$ [mm]	80	90	110	125	170	210	240	270	300	330	360
Base material thickness $h_{min} =$ [mm]	110	120	140	161	218	266	300	340	374	410	450
Spacing $s = s_{min} =$ [mm]	40	50	60	80	100	120	135	150	165	180	195
Tensile N_{Rd}: double anchor, no edge effects, min. spacing ($s = s_{min}$)											
 HIT-V 5.8 [kN]	9,3	11,6	15,5	19,2	30,1	41,2	50,3	59,9	70,1	80,8	92,0
HIT-V 8.8 [kN]											
HIT-V-R [kN]											
HIT-V-HCR [kN]											
Shear V_{Rd}: double anchor, no edge effects, min. spacing ($s = s_{min}$), without lever arm											
 HIT-V 5.8 [kN]	7,2	12,0	16,8	31,2	48,8	70,4	92,0	112,0	138,8	163,4	195,2
HIT-V 8.8 [kN]	12,0	18,4	27,2	50,4	78,4	112,8	147,2	177,0	207,0	238,5	271,5
HIT-V-R [kN]	8,3	12,8	19,2	35,3	55,1	79,5	48,3	58,8	72,9	85,8	102,5
HIT-V-HCR [kN]	12,0	18,4	27,2	50,4	78,4	70,9	92,0	112,0	86,8	102,1	122,0

Design resistance: concrete C 20/25 – $f_{ck,cube} = 25 \text{ N/mm}^2$, Temperature range I

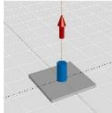
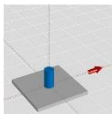
	Data according ETA-04/0027, issue 2013-06-26								Additional Hilti technical data		
Anchor size	M8	M10	M12	M16	M20	M24	M27	M30	M33	M36	M39
Embedment depth $h_{ef,2} =$ [mm]	96	120	144	192	240	288	324	360	396	432	468
Base material thickness $h_{min} =$ [mm]	126	150	174	228	288	344	384	430	470	512	558
Tensile N_{Rd}: single anchor, no edge effects											
 HIT-V 5.8 [kN]	12,0	19,3	28,0	52,7	82,0	117,5	140,2	164,3	189,5	215,9	243,5
HIT-V 8.8 [kN]	18,4	28,7	41,4	64,0	89,4	117,5	140,2	164,3	189,5	215,9	243,5
HIT-V-R [kN]	13,9	21,9	31,6	58,8	89,4	117,5	80,4	98,3	122,6	144,3	172,4
HIT-V-HCR [kN]	18,4	28,7	41,4	64,0	89,4	117,5	140,2	164,3	144,6	170,2	203,3
Shear V_{Rd}: single anchor, no edge effects, without lever arm											
 HIT-V 5.8 [kN]	7,2	12,0	16,8	31,2	48,8	70,4	92,0	112,0	138,8	163,4	195,2
HIT-V 8.8 [kN]	12,0	18,4	27,2	50,4	78,4	112,8	147,2	179,2	222,1	261,4	312,3
HIT-V-R [kN]	8,3	12,8	19,2	35,3	55,1	79,5	48,3	58,8	72,9	85,8	102,5
HIT-V-HCR [kN]	12,0	18,4	27,2	50,4	78,4	70,9	92,0	112,0	86,8	102,1	122,0

Design resistance: concrete C 20/25 – $f_{ck,cube} = 25 \text{ N/mm}^2$, Temperature range I

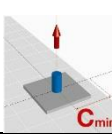
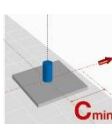
	Data according ETA-04/0027, issue 2013-06-26								Additional Hilti technical data		
Anchor size	M8	M10	M12	M16	M20	M24	M27	M30	M33	M36	M39
Embedment depth $h_{ef,2} =$ [mm]	96	120	144	192	240	288	324	360	396	432	468
Base material thickness $h_{min} =$ [mm]	126	150	174	228	288	344	384	430	470	512	558
Edge distance $c = c_{min} =$ [mm]	40	50	60	80	100	120	135	150	165	180	195
Tensile N_{Rd}: single anchor, min. edge distance ($c = c_{min}$)											
 HIT-V 5.8 [kN]											
HIT-V 8.8 [kN]	9,9	14,1	18,6	28,6	40,0	52,6	62,7	73,5	84,8	96,6	108,9
HIT-V-R [kN]											
HIT-V-HCR [kN]											
Shear V_{Rd}: single anchor, min. edge distance ($c = c_{min}$), without lever arm											
 HIT-V 5.8 [kN]											
HIT-V 8.8 [kN]	3,9	5,7	7,8	12,9	18,9	25,9	31,8	38,1	45,0	52,3	60,0
HIT-V-R [kN]											
HIT-V-HCR [kN]											

Design resistance: concrete C 20/25 – $f_{ck,cube} = 25 \text{ N/mm}^2$, Temperature range I
(load values are valid for single anchor)

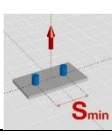
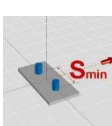
	Data according ETA-04/0027, issue 2013-06-26								Additional Hilti technical data		
Anchor size	M8	M10	M12	M16	M20	M24	M27	M30	M33	M36	M39
Embedment depth $h_{ef,2} =$ [mm]	96	120	144	192	240	288	324	360	396	432	468
Base material thickness $h_{min} =$ [mm]	126	150	174	228	288	344	384	430	470	512	558
Spacing $s = s_{min} =$ [mm]	40	50	60	80	100	120	135	150	165	180	195
Tensile N_{Rd}: double anchor, no edge effects, min. spacing ($s = s_{min}$)											
 HIT-V 5.8 [kN]											
HIT-V 8.8 [kN]	11,5	17,3	22,7	34,9	48,8	64,2	76,6	89,7	103,5	117,9	133,0
HIT-V-R [kN]											
HIT-V-HCR [kN]											
Shear V_{Rd}: double anchor, no edge effects, min. spacing ($s = s_{min}$), without lever arm											
 HIT-V 5.8 [kN]											
HIT-V 8.8 [kN]	7,2	12,0	16,8	31,2	48,8	70,4	92,0	112,0	138,8	163,4	195,2
HIT-V-R [kN]	12,0	18,4	27,2	50,4	78,4	112,8	147,2	179,2	222,1	261,4	312,3
HIT-V-R [kN]	8,3	12,8	19,2	35,3	55,1	79,5	48,3	58,8	72,9	85,8	102,5
HIT-V-HCR [kN]	12,0	18,4	27,2	50,4	78,4	70,9	92,0	112,0	86,8	102,1	122,0

Hilti HIT-RE 500 mortar with HIS-(R)N sleeve

Injection mortar system		Benefits
	<p>Hilti HIT-RE 500 330 ml foil pack (also available as 500 ml and 1400 ml foil pack)</p> <p>Statik mixer</p> <p>HIS-(R)N sleeve</p>	<ul style="list-style-type: none"> - SAFEset technology: drilling and borehole cleaning in one step with Hilti hollow drill bit - suitable for non-cracked concrete C 20/25 to C 50/60 - high loading capacity - suitable for dry and water saturated concrete - under water application for hammer drilled holes - long working time at elevated temperatures - odourless epoxy



Concrete

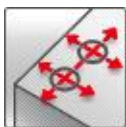

Small edge distance and spacing



Fire resistance

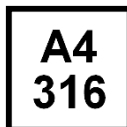

Corrosion resistance



Diamond drilled holes

SAFEset

Hilti **SAFEset** technology with hollow drill bit



European Technical Approval



CE conformity



PROFIS Anchor design software

Approvals / certificates

Description	Authority / Laboratory	No. / date of issue
European technical approval ^{a)}	DIBt, Berlin	ETA-04/0027 / 2013-06-26
Fire test report	IBMB, Brunswick	UB 3565 / 4595 / 2006-10-29 UB 3588 / 4825 / 2005-11-15
Assessment report (fire)	warringtonfire	WF 327804/B / 2013-07-10

a) All data given in this section according ETA-04/0027, issue 2013-06-26.

Basic loading data (for a single anchor)

All data in this section applies to

- Correct setting (See setting instruction)
- No edge distance and spacing influence
- Steel failure
- Screw strength class 8.8
- Base material thickness, as specified in the table
- One typical embedment depth, as specified in the table
- One anchor material, as specified in the tables
- Concrete C 20/25, $f_{ck,cube} = 25 \text{ N/mm}^2$
- Temperature range I
(min. base material temperature -40°C , max. long term/short term base material temperature: $+24^\circ\text{C}/40^\circ\text{C}$)
- Installation temperature range $+5^\circ\text{C}$ to $+40^\circ\text{C}$

For details see Simplified design method

**Embedment depth and base material thickness for the basic loading data.
Mean ultimate resistance, characteristic resistance, design resistance, recommended loads.**

Anchor size	M8	M10	M12	M16	M20
Embedment depth [mm]	90	110	125	170	205
Base material thickness [mm]	120	150	170	230	270

For hammer drilled holes and hollow drill bit:

Mean ultimate resistance ^{a)}: concrete C 20/25 – $f_{ck,cube} = 25 \text{ N/mm}^2$, anchor HIS-N

Data according ETA-04/0027, issue 2013-06-26 for hammer drilling and hollow drill bit						
Anchor size	M8	M10	M12	M16	M20	
Tensile $N_{Ru,m}$ HIS-N [kN]	26,3	48,3	70,4	123,9	114,5	
Shear $V_{Ru,m}$ HIS-N [kN]	13,7	24,2	41,0	62,0	57,8	

Characteristic resistance: concrete C 20/25 – $f_{ck,cube} = 25 \text{ N/mm}^2$, anchor HIS-N

Data according ETA-04/0027, issue 2013-06-26 for hammer drilling and hollow drill bit						
Anchor size	M8	M10	M12	M16	M20	
Tensile N_{Rk} HIS-N [kN]	25,0	46,0	67,0	111,9	109,0	
Shear V_{Rk} HIS-N [kN]	13,0	23,0	39,0	59,0	55,0	

Design resistance: concrete C 20/25 – $f_{ck,cube} = 25 \text{ N/mm}^2$, anchor HIS-N

Data according ETA-04/0027, issue 2013-06-26 for hammer drilling and hollow drill bit						
Anchor size	M8	M10	M12	M16	M20	
Tensile N_{Rd} HIS-N [kN]	16,8	27,7	33,6	53,3	70,6	
Shear V_{Rd} HIS-N [kN]	10,4	18,4	26,0	39,3	36,7	

Recommended loads ^{a)}: concrete C 20/25 – $f_{ck,cube} = 25 \text{ N/mm}^2$, anchor HIS-N

Data according ETA-04/0027, issue 2013-06-26 for hammer drilling and hollow drill bit						
Anchor size	M8	M10	M12	M16	M20	
Tensile N_{rec} HIS-N [kN]	12,0	19,8	24,0	38,1	50,4	
Shear V_{rec} HIS-N [kN]	7,4	13,1	18,6	28,1	26,2	

a) With overall partial safety factor for action $\gamma = 1,4$. The partial safety factors for action depend on the type of loading and shall be taken from national regulations.

For diamond drilling:

Mean ultimate resistance ^{a)}: concrete C 20/25 – $f_{ck,cube} = 25 \text{ N/mm}^2$, anchor HIS-N

			Data according ETA-04/0027, issue 2013-06-26 for diamond drilling				
Anchor size			M8	M10	M12	M16	M20
Tensile $N_{R_{u,m}}$	HIS-N	[kN]	26,3	48,3	70,4	123,9	114,5
Shear $V_{R_{u,m}}$	HIS-N	[kN]	13,7	24,2	41,0	62,0	57,8

Characteristic resistance: concrete C 20/25 – $f_{ck,cube} = 25 \text{ N/mm}^2$, anchor HIS-N

			Data according ETA-04/0027, issue 2013-06-26 for diamond drilling				
Anchor size			M8	M10	M12	M16	M20
Tensile N_{Rk}	HIS-N	[kN]	25,0	46,0	67,0	111,9	109,0
Shear V_{Rk}	HIS-N	[kN]	13,0	23,0	39,0	59,0	55,0

Design resistance: concrete C 20/25 – $f_{ck,cube} = 25 \text{ N/mm}^2$, anchor HIS-N

			Data according ETA-04/0027, issue 2013-06-26 for diamond drilling				
Anchor size			M8	M10	M12	M16	M20
Tensile N_{Rd}	HIS-N	[kN]	16,7	27,7	33,6	53,3	66,7
Shear V_{Rd}	HIS-N	[kN]	10,4	18,4	26,0	39,3	36,7

Recommended loads ^{a)}: concrete C 20/25 – $f_{ck,cube} = 25 \text{ N/mm}^2$, anchor HIS-N

			Data according ETA-04/0027, issue 2013-06-26 for diamond drilling				
Anchor size			M8	M10	M12	M16	M20
Tensile N_{rec}	HIS-N	[kN]	11,9	19,8	24,0	38,1	47,6
Shear V_{rec}	HIS-N	[kN]	7,4	13,1	18,6	28,1	26,2

a) With overall partial safety factor for action $\gamma = 1,4$. The partial safety factors for action depend on the type of loading and shall be taken from national regulations.

Service temperature range

Hilti HIT-RE 500 injection mortar may be applied in the temperature ranges given below. An elevated base material temperature may lead to a reduction of the design bond resistance.

Temperature range	Base material temperature	Maximum long term base material temperature	Maximum short term base material temperature
Temperature range I	-40 °C to +40 °C	+24 °C	+40 °C
Temperature range II	-40 °C to +58 °C	+35 °C	+58 °C
Temperature range III	-40 °C to +70 °C	+43 °C	+70 °C

Max short term base material temperature

Short-term elevated base material temperatures are those that occur over brief intervals, e.g. as a result of diurnal cycling.

Max long term base material temperature

Long-term elevated base material temperatures are roughly constant over significant periods of time.

Materials

Mechanical properties of HIS-(R)N

			Data according ETA-04/0027, issue 2013-06-26				
Anchor size			M8	M10	M12	M16	M20
Nominal tensile strength f_{uk}	HIS-N	[N/mm ²]	490	490	460	460	460
	Screw 8.8	[N/mm ²]	800	800	800	800	800
	HIS-RN	[N/mm ²]	700	700	700	700	700
	Screw A4-70	[N/mm ²]	700	700	700	700	700
Yield strength f_{yk}	HIS-N	[N/mm ²]	410	410	375	375	375
	Screw 8.8	[N/mm ²]	640	640	640	640	640
	HIS-RN	[N/mm ²]	350	350	350	350	350
	Screw A4-70	[N/mm ²]	450	450	450	450	450
Stressed cross-section A_s	HIS-(R)N	[mm ²]	51,5	108,0	169,1	256,1	237,6
	Screw	[mm ²]	36,6	58	84,3	157	245
Moment of resistance W	HIS-(R)N	[mm ³]	145	430	840	1595	1543
	Screw	[mm ³]	31,2	62,3	109	277	541

Material quality

Part	Material
internally threaded sleeves ^{a)} HIS-N	C-steel 1.0718, steel galvanized $\geq 5\mu\text{m}$
internally threaded sleeves ^{b)} HIS-RN	stainless steel 1.4401 and 1.4571

a) related fastening screw: strength class 8.8, A5 > 8% Ductile steel galvanized $\geq 5\mu\text{m}$

b) related fastening screw: strength class 70, A5 > 8% Ductile stainless steel 1.4401; 1.4404; 1.4578; 1.4571; 1.4439; 1.4362

Anchor dimensions

Anchor size	M8	M10	M12	M16	M20
Internal sleeve HIS-(R)N	M8x90	M10x110	M12x125	M16x170	M20x205
Anchor embedment depth [mm]	90	110	125	170	205

Setting

installation equipment

Anchor size	M8	M10	M12	M16	M20
Rotary hammer	TE 2 – TE 16		TE 40 – TE 70		
Other tools	compressed air gun or blow out pump, set of cleaning brushes, dispenser				
Additional Hilti recommended tools	DD EC-1, DD 100 ... DD xxx ^{a)}				

a) For anchors in diamond drilled holes load values for combined pull-out and concrete cone resistance have to be reduced (see section "Setting instruction")

Setting instruction

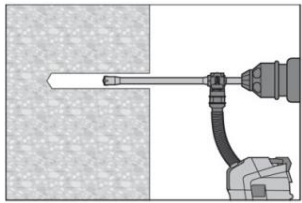
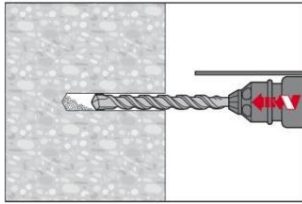
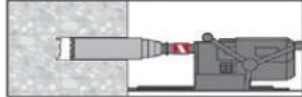
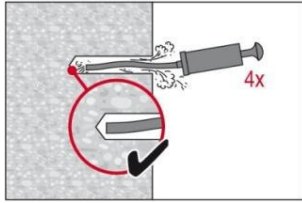
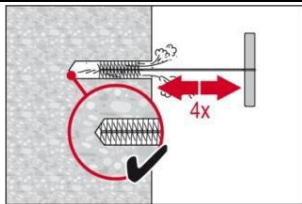
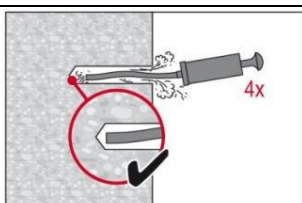
Bore hole drilling	
a) Hilti hollow drill bit	(for dry and wet concrete only)
	Drill hole to the required embedment depth with an appropriately sized Hilti TE-CD or TE-YD hollow drill bit with Hilti vacuum attachment. This drilling system removes the dust and cleans the bore hole during drilling when used in accordance with the user's manual. After drilling is complete, proceed to the "injection preparation" step in the instructions for use.
b) Hammer drilling	(dry or wet concrete and installation in flooded holes (no sea water))
	Drill Hole to the required embedment depth with a hammer drill set in rotation-hammer mode using an appropriately sized carbide drill bit.
c) Diamond coring	(for dry and wet concrete only)
	Diamond coring is permissible when diamond core drilling machine and the corresponding core bit are used.
Bore hole cleaning Just before setting an anchor, the bore hole must be free of dust and debris.	
a) Manual Cleaning (MC) non-cracked concrete only for bore hole diameters $d_0 \leq 20\text{mm}$ and bore hole depth $h_0 \leq 20d$ or $h_0 \leq 250\text{ mm}$ ($d = \text{diameter of element}$)	
	The Hilti manual pump may be used for blowing out bore holes up to diameters $d_0 \leq 20\text{ mm}$ and embedment depths up to $h_{ef} \leq 10d$. Blow out at least 4 times from the back of the bore hole until return air stream is free of noticeable dust
	Brush 4 times with the specified brush size (brush diameter \geq bore hole) by inserting the steel brush Hilti HIT-RB to the back of the hole (if needed with extension) in a twisting motion and removing it. The brush must produce natural resistance as it enters the bore hole - if not the brush is too small and must be replaced with the proper brush diameter.
	Blow out again with manual pump at least 4 times until return air stream is free of noticeable dust.

b) Compressed air cleaning (CAC)

for all bore hole diameters d_0 and all bore hole depth h_0

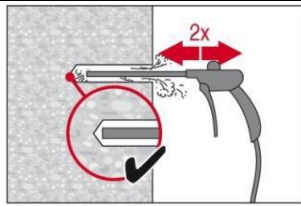

Blow 2 times from the back of the hole (if needed with nozzle extension) over the hole length with oil-free compressed air (min. 6 bar at 6 m³/h) until return air stream is free of noticeable dust.

Bore hole diameter ≥ 32 mm the compressor must supply a minimum air flow of 140 m³/hour.

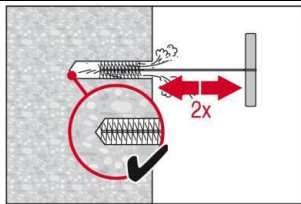

Brush 2 times with the specified brush size by inserting the steel brush Hilti HIT-RB to the back of the hole (if needed with extension) in a twisting motion and removing it.

The brush must produce natural resistance as it enters the bore hole - if not the brush is too small and must be replaced with the proper brush diameter.

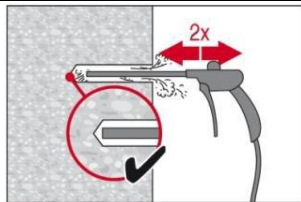

Blow again with compressed air 2 times until return air stream is free of noticeable dust.

c) Cleaning for under water

for all bore hole diameters d_0 and all bore hole depth h_0

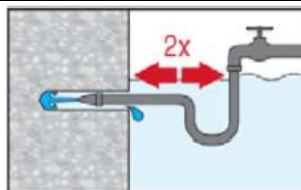

Flush 2 times the hole by inserting a water hose (water-line pressure) to the back of the hole until water runs clear.

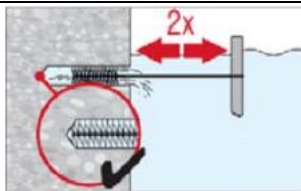

Brush 2 times with the specified brush size by inserting the steel brush Hilti HIT-RB to the back of the hole (if needed with extension) in a twisting motion and removing it.

The brush must produce natural resistance as it enters the bore hole - if not the brush is too small and must be replaced with the proper brush diameter.

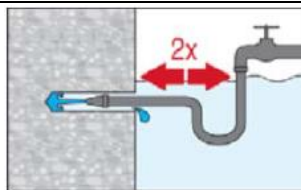

Flush again 2 times the hole by inserting a water hose (water-line pressure) to the back of the hole until water runs clear.

d) Cleaning of hammer drilled holes and diamond cored holes

for all bore hole diameters d_0 and all bore hole depth h_0

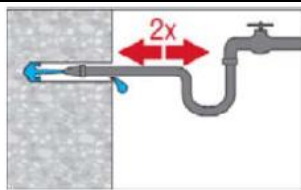

Flush 2 times the hole by inserting a water hose (water-line pressure) to the back of the hole until water runs clear.

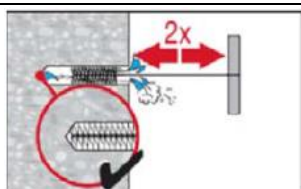

Brush 2 times with the specified brush size by inserting the steel brush Hilti HIT-RB to the back of the hole (if needed with extension) in a twisting motion and removing it.

The brush must produce natural resistance as it enters the bore hole - if not the brush is too small and must be replaced with the proper brush diameter.

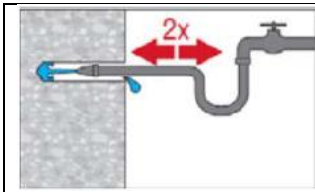

Flush again 2 times the hole by inserting a water hose (water-line pressure) to the back of the hole until water runs clear.

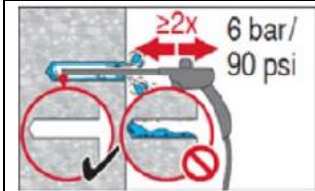

Blow 2 times from the back of the hole (if needed with nozzle extension) over the hole length with oil-free compressed air (min. 6 bar at 6 m³/h) until return air stream is free of noticeable dust and water.

Bore hole diameter ≥ 32 mm the compressor must supply a minimum air flow of 140 m³/hour.

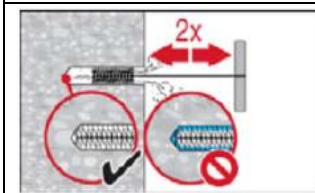

Brush 2 times with the specified brush size by inserting the steel brush Hilti HIT-RB to the back of the hole (if needed with extension) in a twisting motion and removing it.

The brush must produce natural resistance as it enters the bore hole - if not the brush is too small and must be replaced with the proper brush diameter.

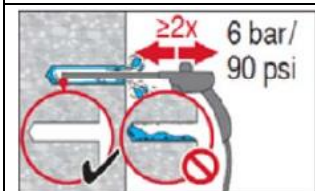

Blow again with compressed air 2 times until return air stream is free of noticeable dust and water.

Injection preparation

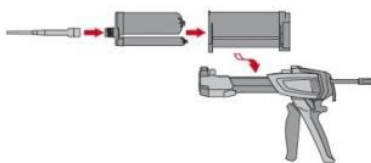

Tightly attach new Hilti mixing nozzle HIT-RE-M to foil pack manifold (snug fit). Do not modify the mixing nozzle. Observe the instruction for use of the dispenser and mortar.

Check foil pack holder for proper function. Do not use damaged foil packs / holders.

Insert foil pack into foil pack holder and put holder into HIT-dispenser.

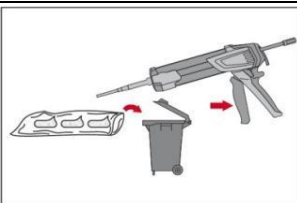

The foil pack opens automatically as dispensing is initiated. Discard initial adhesive. Depending on the size of the foil pack an initial amount of adhesive has to be discarded.

Discard quantities are:

- 2 strokes for 330 ml foil pack,
- 3 strokes for 500 ml foil pack,
- 65 ml for 1400 ml foil pack.

Inject adhesive from the back of the borehole without forming air voids

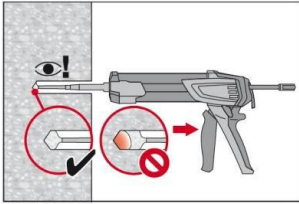

Inject the adhesive starting at the back of the hole, slowly withdrawing the mixer with each trigger pull. Fill holes approximately 2/3 full. It is required that the annular gap between the anchor and the concrete is completely filled with adhesive along the embedment length.

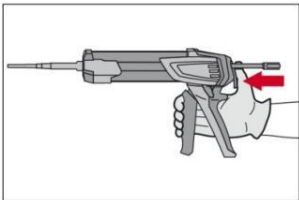

After injection is completed, depressurize the dispenser by pressing the release trigger. This will prevent further adhesive discharge from the mixer.

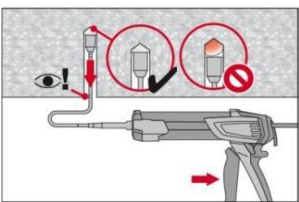

Overhead installation and/or installation with embedment depth $h_{ef} > 250\text{mm}$.

For overhead installation the injection is only possible with the aid of extensions and piston plugs. Assemble HIT-RE-M mixer, extension(s) and appropriately sized piston plug HIT-SZ. Insert piston plug to back of the hole and inject adhesive. During injection the piston plug will be naturally extruded out of the bore hole by the adhesive pressure.

Under water application: fill borehole completely with mortar.

Setting the element

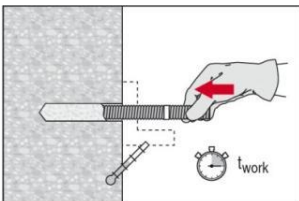

Before use, verify that the element is dry and free of oil and other contaminants. Mark and set element to the required embedment depth until working time t_{work} has elapsed.

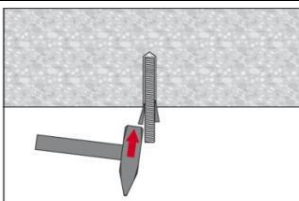

For overhead installation use piston plugs and fix embedded parts with e.g. wedges HIT-OHW.

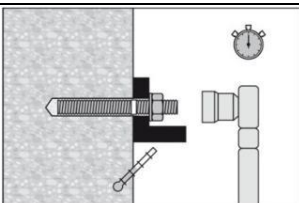

Loading the anchor:
After required curing time t_{cure} the anchor can be loaded.
The applied installation torque shall not exceed T_{max} .

For detailed information on installation see instruction for use given with the package of the product.

Curing time for general conditions

Data according ETA-04/0027, issue 2013-06-26		
Temperature of the base material	Working time in which anchor can be inserted and adjusted t_{gel}	Curing time before anchor can be fully loaded t_{cure}
40 °C	12 min	4 h
30 °C to 39 °C	12 min	8 h
20 °C to 29 °C	20 min	12 h
15 °C to 19 °C	30 min	24 h
10 °C to 14 °C	90 min	48 h
5 °C to 9 °C	120 min	72 h

For dry concrete curing times may be reduced according to the following table.

For installation temperatures below +5 °C all load values have to be reduced according to the load reduction factors given below.

Curing time for dry concrete

Additional Hilti technical data			
Temperature of the base material	Working time in which anchor can be inserted and adjusted t_{gel}	Reduced curing time before anchor can be fully loaded $t_{cure,dry}$	Load reduction factor
40 °C	12 min	4 h	1
30 °C	12 min	8 h	1
20 °C	20 min	12 h	1
15 °C	30 min	18 h	1
10 °C	90 min	24 h	1
5 °C	120 min	36 h	1
0 °C	3 h	50 h	0,7
-5 °C	4 h	72 h	0,6

Setting details

		Data according ETA-04/0027, issue 2013-06-26				
Anchor size		M8	M10	M12	M16	M20
Nominal diameter of drill bit	d_0 [mm]	14	18	22	28	32
Diameter of element	d [mm]	12,5	16,5	20,5	25,4	27,6
Effective anchorage and drill hole depth	h_{ef} [mm]	90	110	125	170	205
Minimum base material thickness	h_{min} [mm]	120	150	170	230	270
Diameter of clearance hole in the fixture	d_f [mm]	9	12	14	18	22
Thread engagement length; min - max	h_s [mm]	8-20	10-25	12-30	16-40	20-50
Minimum spacing	s_{min} [mm]	40	45	55	65	90
Minimum edge distance	c_{min} [mm]	40	45	55	65	90
Critical spacing for splitting failure	$s_{cr,sp}$	$2 c_{cr,sp}$				
Critical edge distance for splitting failure ^{a)}	$c_{cr,sp}$ [mm]	$1,0 \cdot h_{ef}$ for $h / h_{ef} \geq 2,0$				
		$4,6 h_{ef} - 1,8 h$ for $2,0 > h / h_{ef} > 1,3$				
		$2,26 h_{ef}$ for $h / h_{ef} \leq 1,3$				
Critical spacing for concrete cone failure	$s_{cr,N}$	$2 c_{cr,N}$				
Critical edge distance for concrete cone failure ^{c)}	$c_{cr,N}$	$1,5 h_{ef}$				
Torque moment ^{c)}	T_{max} [Nm]	10	20	40	80	150

For spacing (edge distance) smaller than critical spacing (critical edge distance) the design loads have to be reduced.

- a) h : base material thickness ($h \geq h_{min}$)
- b) The critical edge distance for concrete cone failure depends on the embedment depth h_{ef} and the design bond resistance. The simplified formula given in this table is on the safe side.
- c) This is the maximum recommended torque moment to avoid splitting failure during installation for anchors with minimum spacing and/or edge distance.

Simplified design method

Simplified version of the design method according ETAG 001, TR 029. Design resistance according data given in ETA-04/0027, issue 2013-06-26.

- Influence of concrete strength
- Influence of edge distance
- Influence of spacing
- Valid for a group of two anchors. (The method may also be applied for anchor groups with more than two anchors or more than one edge distance. The influencing factors must then be considered for each edge distance and spacing. The calculated design loads are then on the save side: They will be lower than the exact values according ETAG 001, TR 029. To avoid this, it is recommended to use the anchor design software PROFIS anchor)

The design method is based on the following simplification:

- No different loads are acting on individual anchors (no eccentricity)

The values are valid for one anchor.

For more complex fastening applications please use the anchor design software PROFIS Anchor.

Tension loading

The design tensile resistance is the lower value of

- Steel resistance: $N_{Rd,s}$
- Combined pull-out and concrete cone resistance:
 $N_{Rd,p} = N_{Rd,p}^0 \cdot f_{B,p} \cdot f_{1,N} \cdot f_{2,N} \cdot f_{3,N} \cdot f_{h,p} \cdot f_{re,N}$
- Concrete cone resistance: $N_{Rd,c} = N_{Rd,c}^0 \cdot f_B \cdot f_{1,N} \cdot f_{2,N} \cdot f_{3,N} \cdot f_{h,N} \cdot f_{re,N}$
- Concrete splitting resistance (only non-cracked concrete):
 $N_{Rd,sp} = N_{Rd,c}^0 \cdot f_B \cdot f_{1,sp} \cdot f_{2,sp} \cdot f_{3,sp} \cdot f_{h,N} \cdot f_{re,N}$

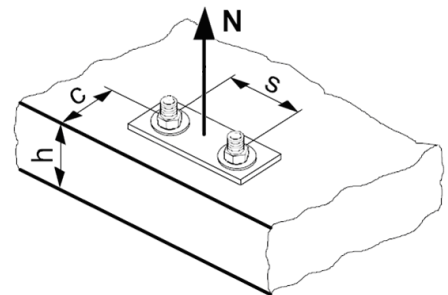

Basic design tensile resistance

Design steel resistance $N_{Rd,s}$

		Data according ETA-04/0027, issue 2013-06-26				
Anchor size		M8	M10	M12	M16	M20
$N_{Rd,s}$	HIS-N [kN]	16,8	30,7	44,7	80,3	74,1
	HIS-RN [kN]	13,9	21,9	31,6	58,8	69,2

Design combined pull-out and concrete cone resistance ^{a)}

$$N_{Rd,p} = N_{Rd,p}^0 \cdot f_{B,p} \cdot f_{1,N} \cdot f_{2,N} \cdot f_{3,N} \cdot f_{h,p} \cdot f_{re,N}$$

			Data according ETA-04/0027, issue 2013-06-26				
Anchor size			M8	M10	M12	M16	M20
Embedment depth h_{ef} [mm]			90	110	125	170	205
Hammer drilling + Hilti hollow drill bit	$N_{Rd,p}^0$	Temp range I [kN]	19,0	28,6	45,2	81,0	95,2
	$N_{Rd,p}^0$	Temp range II [kN]	16,7	23,8	35,7	66,7	81,0
	$N_{Rd,p}^0$	Temp. range III [kN]	9,5	14,3	19,0	35,7	45,2
Diamond coring	$N_{Rd,p}^0$	Temp range I [kN]	22,2	28,6	35,7	54,8	66,7
	$N_{Rd,p}^0$	Temp range II [kN]	19,4	27,8	33,3	45,2	54,8
	$N_{Rd,p}^0$	Temp. range III [kN]	11,1	16,7	22,2	35,7	45,2

a) **Additional Hilti technical data (not part of ETA-04/0027, issue 2009-05-20):**

The design values for combined pull-out and concrete cone resistance may be increased by 20 % for anchor installation in dry concrete (concrete not in contact with water before/during installation and curing).

Design concrete cone resistance ^{a)} $N_{Rd,c} = N_{Rd,c}^0 \cdot f_B \cdot f_{1,N} \cdot f_{2,N} \cdot f_{3,N} \cdot f_{h,N} \cdot f_{re,N}$

Design splitting resistance $N_{Rd,sp} = N_{Rd,c}^0 \cdot f_B \cdot f_{1,sp} \cdot f_{2,sp} \cdot f_{3,sp} \cdot f_{h,N} \cdot f_{re,N}$

			Data according ETA-04/0027, issue 2013-06-26				
Anchor size			M8	M10	M12	M16	M20
$N_{Rd,c}^0$	[kN]		20,5	27,7	33,6	53,3	70,6

a) **Additional Hilti technical data (not part of ETA-04/0027, issue 2009-05-20):**

The design values for concrete cone and splitting resistance may be increased by 20 % for anchor installation in dry concrete (concrete not in contact with water before/during installation and curing).

Influencing factors

Influence of concrete strength on combined pull-out and concrete cone resistance

Concrete strength designation (ENV 206)	C 20/25	C 25/30	C 30/37	C 35/45	C 40/50	C 45/55	C 50/60
$f_{B,p} = (f_{ck,cube}/25N/mm^2)^{0,1}$ ^{a)}	1	1,02	1,04	1,06	1,07	1,08	1,09

a) $f_{ck,cube}$ = concrete compressive strength, measured on cubes with 150 mm side length

Influence of embedment depth on combined pull-out and concrete cone resistance

$f_{h,p} = 1$

Influence of concrete strength on concrete cone resistance

Concrete strength designation (ENV 206)	C 20/25	C 25/30	C 30/37	C 35/45	C 40/50	C 45/55	C 50/60
$f_B = (f_{ck,cube}/25N/mm^2)^{1/2}$ ^{a)}	1	1,1	1,22	1,34	1,41	1,48	1,55

a) $f_{ck,cube}$ = concrete compressive strength, measured on cubes with 150 mm side length

Influence of edge distance ^{a)}

$c/c_{cr,N}$	0,1	0,2	0,3	0,4	0,5	0,6	0,7	0,8	0,9	1
$c/c_{cr,sp}$										
$f_{1,N} = 0,7 + 0,3 \cdot c/c_{cr,N}$	0,73	0,76	0,79	0,82	0,85	0,88	0,91	0,94	0,97	1
$f_{1,sp} = 0,7 + 0,3 \cdot c/c_{cr,sp}$										
$f_{2,N} = 0,5 \cdot (1 + c/c_{cr,N})$	0,55	0,60	0,65	0,70	0,75	0,80	0,85	0,90	0,95	1
$f_{2,sp} = 0,5 \cdot (1 + c/c_{cr,sp})$										

a) The edge distance shall not be smaller than the minimum edge distance c_{min} given in the table with the setting details. These influencing factors must be considered for every edge distance smaller than the critical edge distance.

Influence of anchor spacing ^{a)}

$s/s_{cr,N}$	0,1	0,2	0,3	0,4	0,5	0,6	0,7	0,8	0,9	1
$s/s_{cr,sp}$										
$f_{3,N} = 0,5 \cdot (1 + s/s_{cr,N})$	0,55	0,60	0,65	0,70	0,75	0,80	0,85	0,90	0,95	1
$f_{3,sp} = 0,5 \cdot (1 + s/s_{cr,sp})$										

a) The anchor spacing shall not be smaller than the minimum anchor spacing s_{min} given in the table with the setting details. This influencing factor must be considered for every anchor spacing.

Influence of embedment depth on concrete cone resistance

$f_{h,N} = 1$

Influence of reinforcement

h_{ef} [mm]	80	90	≥ 100
$f_{re,N} = 0,5 + h_{ef}/200mm \leq 1$	0,9 ^{a)}	0,95 ^{a)}	1

a) This factor applies only for dense reinforcement. If in the area of anchorage there is reinforcement with a spacing ≥ 150 mm (any diameter) or with a diameter ≤ 10 mm and a spacing ≥ 100 mm, then a factor $f_{re} = 1$ may be applied.

Shear loading

The design shear resistance is the lower value of

- Steel resistance: $V_{Rd,s}$
- Concrete pryout resistance: $V_{Rd,cp} = k \cdot \text{lower value of } N_{Rd,p} \text{ and } N_{Rd,c}$
- Concrete edge resistance: $V_{Rd,c} = V_{Rd,c}^0 \cdot f_B \cdot f_{\beta} \cdot f_h \cdot f_4 \cdot f_{hef} \cdot f_c$

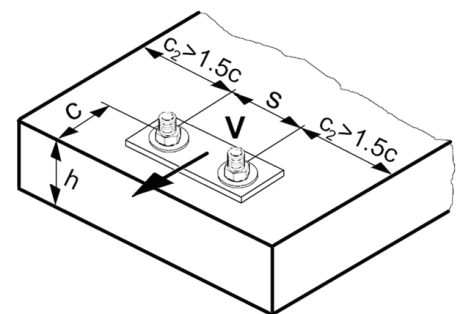

Basic design shear resistance

Design steel resistance $V_{Rd,s}$

		Data according ETA-04/0027, issue 2013-06-26				
Anchor size		M8	M10	M12	M16	M20
$V_{Rd,s}$	HIS-N [kN]	10,4	18,4	26,0	39,3	36,7
	HIS-RN [kN]	8,3	12,8	19,2	35,3	41,5

Design concrete pryout resistance $V_{Rd,cp}$ = lower value^{a)} of $k \cdot N_{Rd,p}$ and $k \cdot N_{Rd,c}$

$k = 1$ for $h_{ef} < 60$ mm

$k = 2$ for $h_{ef} \geq 60$ mm

- a) $N_{Rd,p}$: Design combined pull-out and concrete cone resistance
 $N_{Rd,c}$: Design concrete cone resistance

Design concrete edge resistance $V_{Rd,c} = V_{Rd,c}^0 \cdot f_B \cdot f_{\beta} \cdot f_h \cdot f_4 \cdot f_{hef} \cdot f_c$

Anchor size		M8	M10	M12	M16	M20
Non-cracked concrete						
$V_{Rd,c}^0$ [kN]		12,4	19,6	28,2	40,2	46,2

Influencing factors

Influence of concrete strength

Concrete strength designation (ENV 206)	C 20/25	C 25/30	C 30/37	C 35/45	C 40/50	C 45/55	C 50/60
$f_B = (f_{ck,cube}/25N/mm^2)^{1/2}$ a)	1	1,1	1,22	1,34	1,41	1,48	1,55

- a) $f_{ck,cube}$ = concrete compressive strength, measured on cubes with 150 mm side length

Influence of angle between load applied and the direction perpendicular to the free edge

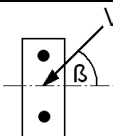
Angle β	0°	10°	20°	30°	40°	50°	60°	70°	80°	≥ 90°
$f_{\beta} = \frac{1}{\sqrt{(\cos \alpha_V)^2 + \left(\frac{\sin \alpha_V}{2,5}\right)^2}}$ 	1	1,01	1,05	1,13	1,24	1,40	1,64	1,97	2,32	2,50

Influence of base material thickness

h/c	0,15	0,3	0,45	0,6	0,75	0,9	1,05	1,2	1,35	≥ 1,5
$f_h = \{h/(1,5 \cdot c)\}^{1/2} \leq 1$	0,32	0,45	0,55	0,63	0,71	0,77	0,84	0,89	0,95	1,00

Influence of anchor spacing and edge distance ^{a)} for concrete edge resistance: f_4
 $f_4 = (c/h_{ef})^{1,5} \cdot (1 + s / [3 \cdot c]) \cdot 0,5$

c/h _{ef}	Single anchor	Group of two anchors s/h _{ef}														
		0,75	1,50	2,25	3,00	3,75	4,50	5,25	6,00	6,75	7,50	8,25	9,00	9,75	10,50	11,25
0,50	0,35	0,27	0,35	0,35	0,35	0,35	0,35	0,35	0,35	0,35	0,35	0,35	0,35	0,35	0,35	0,35
0,75	0,65	0,43	0,54	0,65	0,65	0,65	0,65	0,65	0,65	0,65	0,65	0,65	0,65	0,65	0,65	0,65
1,00	1,00	0,63	0,75	0,88	1,00	1,00	1,00	1,00	1,00	1,00	1,00	1,00	1,00	1,00	1,00	1,00
1,25	1,40	0,84	0,98	1,12	1,26	1,40	1,40	1,40	1,40	1,40	1,40	1,40	1,40	1,40	1,40	1,40
1,50	1,84	1,07	1,22	1,38	1,53	1,68	1,84	1,84	1,84	1,84	1,84	1,84	1,84	1,84	1,84	1,84
1,75	2,32	1,32	1,49	1,65	1,82	1,98	2,15	2,32	2,32	2,32	2,32	2,32	2,32	2,32	2,32	2,32
2,00	2,83	1,59	1,77	1,94	2,12	2,30	2,47	2,65	2,83	2,83	2,83	2,83	2,83	2,83	2,83	2,83
2,25	3,38	1,88	2,06	2,25	2,44	2,63	2,81	3,00	3,19	3,38	3,38	3,38	3,38	3,38	3,38	3,38
2,50	3,95	2,17	2,37	2,57	2,77	2,96	3,16	3,36	3,56	3,76	3,95	3,95	3,95	3,95	3,95	3,95
2,75	4,56	2,49	2,69	2,90	3,11	3,32	3,52	3,73	3,94	4,15	4,35	4,56	4,56	4,56	4,56	4,56
3,00	5,20	2,81	3,03	3,25	3,46	3,68	3,90	4,11	4,33	4,55	4,76	4,98	5,20	5,20	5,20	5,20
3,25	5,86	3,15	3,38	3,61	3,83	4,06	4,28	4,51	4,73	4,96	5,18	5,41	5,63	5,86	5,86	5,86
3,50	6,55	3,51	3,74	3,98	4,21	4,44	4,68	4,91	5,14	5,38	5,61	5,85	6,08	6,31	6,55	6,55
3,75	7,26	3,87	4,12	4,36	4,60	4,84	5,08	5,33	5,57	5,81	6,05	6,29	6,54	6,78	7,02	7,26
4,00	8,00	4,25	4,50	4,75	5,00	5,25	5,50	5,75	6,00	6,25	6,50	6,75	7,00	7,25	7,50	7,75
4,25	8,76	4,64	4,90	5,15	5,41	5,67	5,93	6,18	6,44	6,70	6,96	7,22	7,47	7,73	7,99	8,25
4,50	9,55	5,04	5,30	5,57	5,83	6,10	6,36	6,63	6,89	7,16	7,42	7,69	7,95	8,22	8,49	8,75
4,75	10,35	5,45	5,72	5,99	6,27	6,54	6,81	7,08	7,36	7,63	7,90	8,17	8,45	8,72	8,99	9,26
5,00	11,18	5,87	6,15	6,43	6,71	6,99	7,27	7,55	7,83	8,11	8,39	8,66	8,94	9,22	9,50	9,78
5,25	12,03	6,30	6,59	6,87	7,16	7,45	7,73	8,02	8,31	8,59	8,88	9,17	9,45	9,74	10,02	10,31
5,50	12,90	6,74	7,04	7,33	7,62	7,92	8,21	8,50	8,79	9,09	9,38	9,67	9,97	10,26	10,55	10,85

a) The anchor spacing and the edge distance shall not be smaller than the minimum anchor spacing s_{min} and the minimum edge distance c_{min} .

Influence of embedment depth

Anchor size	M8	M10	M12	M16	M20
$f_{hef} =$	1,38	1,21	1,04	1,22	1,45

Influence of edge distance ^{a)}

c/d	4	6	8	10	15	20	30	40
$f_c = (d / c)^{0,19}$	0,77	0,71	0,67	0,65	0,60	0,57	0,52	0,50

a) The edge distance shall not be smaller than the minimum edge distance c_{min} .

Combined tension and shear loading for hammer drilling or hollow drill bit

For combined tension and shear loading see section "Anchor Design".

Precalculated values

Recommended loads can be calculated by dividing the design resistance by an overall partial safety factor for action $\gamma = 1,4$. The partial safety factors for action depend on the type of loading and shall be taken from national regulations.

Design resistance: concrete C 20/25 – $f_{ck,cube} = 25 \text{ N/mm}^2$, Temperature range I

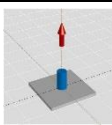
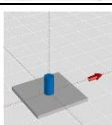
		Data according ETA-04/0027, issue 2013-06-26				
Anchor size		M8	M10	M12	M16	M20
Embedment depth	$h_{ef} =$ [mm]	90	110	125	170	205
Base material thickness	$h_{min} =$ [mm]	120	150	170	230	270
	Tensile N_{Rd}: single anchor, no edge effects					
	HIS-N [kN]	16,8	27,7	33,6	53,3	70,6
	HIS-RN [kN]	13,9	21,9	31,6	53,3	69,2
	Shear V_{Rd}: single anchor, no edge effects, without lever arm					
	HIS-N [kN]	10,4	18,4	26,0	39,3	36,7
	HIS-RN [kN]	8,3	12,8	19,2	35,3	41,5

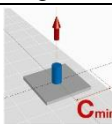
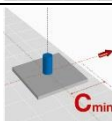

Design resistance: concrete C 20/25 – $f_{ck,cube} = 25 \text{ N/mm}^2$, Temperature range I

		Data according ETA-04/0027, issue 2013-06-26				
Anchor size		M8	M10	M12	M16	M20
Embedment depth	$h_{ef} =$ [mm]	90	110	125	170	205
Base material thickness	$h_{min} =$ [mm]	120	150	170	230	270
Edge distance	$c = c_{min} =$ [mm]	40	45	55	65	90
	Tensile N_{Rd}: single anchor, min. edge distance ($c = c_{min}$)					
	HIS-(R)N [kN]	9,4	12,4	15,4	23,5	32,0
	Shear V_{Rd}: single anchor, min. edge distance ($c = c_{min}$), without lever arm					
	HIS-(R)N [kN]	4,2	5,5	7,6	10,8	17,2

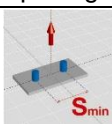
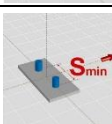
Design resistance: concrete C 20/25 – $f_{ck,cube} = 25 \text{ N/mm}^2$, Temperature range I
(load values are valid for single anchor)

		Data according ETA-04/0027, issue 2013-06-26				
Anchor size		M8	M10	M12	M16	M20
Embedment depth	$h_{ef} =$ [mm]	90	110	125	170	205
Base material thickness	$h_{min} =$ [mm]	120	150	170	230	270
Spacing	$s = s_{min} =$ [mm]	40	45	55	65	90
	Tensile N_{Rd}: double anchor, no edge effects, min. spacing ($s = s_{min}$)					
	HIS-(R)N [kN]	11,2	15,2	18,5	29,0	38,8
	Shear V_{Rd}: double anchor, no edge effects, min. spacing ($s = s_{min}$), without lever arm					
	HIS-N [kN]	10,4	18,4	26,0	39,3	36,7
	HIS-RN [kN]	8,3	12,8	19,2	35,3	41,5

Hilti HIT-RE 500 mortar with rebar (as anchor)

Injection mortar system		Benefits
	<p>Hilti HIT-RE 500 330 ml foil pack (also available as 500 ml and 1400 ml foil pack)</p> <p>Statik mixer</p>	<ul style="list-style-type: none"> - SAFEset technology: drilling and borehole cleaning in one step with Hilti hollow drill bit - suitable for non-cracked concrete C 20/25 to C 50/60 - high loading capacity - suitable for dry and water saturated concrete - under water application - large diameter applications - long working time at elevated temperatures - odourless epoxy - embedment depth range: from 60 ... 160 mm for Ø8 to 128 ... 640 mm for Ø32
	<p>rebar BSt 500 S</p>	



Concrete

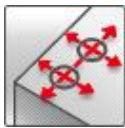

Small edge distance and spacing

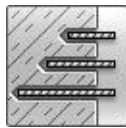

Variable embedment depth



Diamond drilled holes

SAFEset

Hilti **SAFEset** technology with hollow drill bit



European Technical Approval



CE conformity



PROFIS Anchor design software

Approvals / certificates

Description	Authority / Laboratory	No. / date of issue
European technical approval ^{a)}	DIBt, Berlin	ETA-04/0027 / 2013-06-26

a) All data given in this section according ETA-04/0027, issue 2013-06-26

Basic loading data (for a single anchor)

All data in this section applies to

For details see Simplified design method

- Correct setting (See setting instruction)
- No edge distance and spacing influence
- Steel failure
- Base material thickness, as specified in the table
- One typical embedment depth, as specified in the table
- One anchor material, as specified in the tables
- Concrete C 20/25, $f_{ck,cube} = 25 \text{ N/mm}^2$
- Temperate range I
(min. base material temperature -40°C , max. long term/short term base material temperature: $+24^\circ\text{C}/40^\circ\text{C}$)
- Installation temperature range $+5^\circ\text{C}$ to $+40^\circ\text{C}$

Embedment depth ^{a)} and base material thickness for the basic loading data. Mean ultimate resistance, characteristic resistance, design resistance, recommended loads.

	ETA-04/0027, issue issue 2013-06-26										Additional Hilti tech. data	
Anchor size	Ø8	Ø10	Ø12	Ø14	Ø16	Ø20	Ø25	Ø28	Ø32	Ø36	Ø40	
Typical embedment depth [mm]	80	90	110	125	125	170	210	270	300	330	360	
Base material thickness [mm]	110	120	145	165	165	220	275	340	380	420	470	

a) The allowed range of embedment depth is shown in the setting details. The corresponding load values can be calculated according to the simplified design method.

For hammer drilled holes and hollow drill bit:

Mean ultimate resistance: concrete C 20/25 – $f_{ck,cube} = 25 \text{ N/mm}^2$, anchor rebar BSt 500S

	ETA-04/0027, issue issue 2013-06-26 for hammer drilling and hollow drill bit										Additional Hilti tech. data	
Anchor size	Ø8	Ø10	Ø12	Ø14	Ø16	Ø20	Ø25	Ø28	Ø32	Ø36	Ø40	
Tensile $N_{Ru,m}$ BSt 500 S [kN]	29,4	45,2	65,1	89,3	94,1	149,2	204,9	298,7	349,9	403,6	459,9	
Shear $V_{Ru,m}$ BSt 500 S [kN]	14,7	23,1	32,6	44,1	57,8	90,3	141,8	177,5	232,1	293,9	362,9	

Characteristic resistance: concrete C 20/25 – $f_{ck,cube} = 25 \text{ N/mm}^2$, anchor rebar BSt 500 S

	ETA-04/0027, issue issue 2013-06-26 for hammer drilling and hollow drill bit										Additional Hilti tech. data	
Anchor size	Ø8	Ø10	Ø12	Ø14	Ø16	Ø20	Ø25	Ø28	Ø32	Ø36	Ø40	
Tensile N_{Rk} BSt 500 S [kN]	28,0	42,4	58,3	70,6	70,6	111,9	153,7	224,0	262,4	302,7	344,9	
Shear V_{Rk} BSt 500 S [kN]	14,0	22,0	31,0	42,0	55,0	86,0	135,0	169,0	221,0	279,9	345,6	

Design resistance: concrete C 20/25 – $f_{ck,cube} = 25 \text{ N/mm}^2$, anchor rebar BSt 500 S

	ETA-04/0027, issue issue 2013-06-26 for hammer drilling and hollow drill bit										Additional Hilti tech. data	
Anchor size	Ø8	Ø10	Ø12	Ø14	Ø16	Ø20	Ø25	Ø28	Ø32	Ø36	Ø40	
Tensile N_{Rd} BSt 500 S [kN]	14,4	20,2	27,7	33,6	33,6	53,3	73,2	106,7	125,0	144,2	164,3	
Shear V_{Rd} BSt 500 S [kN]	9,3	14,7	20,7	28,0	36,7	57,3	90,0	112,7	147,3	186,6	230,4	

Recommended loads ^{a)}: concrete C 20/25 – $f_{ck,cube} = 25 \text{ N/mm}^2$, anchor rebar BSt 500 S

	ETA-04/0027, issue issue 2013-06-26 for hammer drilling and hollow drill bit										Additional Hilti tech. data	
Anchor size	Ø8	Ø10	Ø12	Ø14	Ø16	Ø20	Ø25	Ø28	Ø32	Ø36	Ø40	
Tensile N_{rec} BSt 500 S [kN]	10,3	14,4	19,8	24,0	24,0	38,1	52,3	76,2	89,3	103,0	117,3	
Shear V_{rec} BSt 500 S [kN]	6,7	10,5	14,8	20,0	26,2	41,0	64,3	80,5	105,2	133,3	164,6	

a) With overall partial safety factor for action $\gamma = 1,4$. The partial safety factors for action depend on the type of loading and shall be taken from national regulations.

For diamond drilling:

Mean ultimate resistance: concrete C 20/25 – $f_{ck,cube} = 25 \text{ N/mm}^2$, anchor rebar BSt 500S

		ETA-04/0027, issue issue 2013-06-26 for diamond drilling								
Anchor size		Ø8	Ø10	Ø12	Ø14	Ø16	Ø20	Ø25	Ø28	32
Tensile $N_{Ru,m}$	BSt 500 S [kN]	29,4	45,0	65,1	68,2	91,8	141,8	178,7	243,2	262,8
Shear $V_{Ru,m}$	BSt 500 S [kN]	14,7	23,1	32,6	44,1	57,75	90,3	141,8	177,5	232,1

Characteristic resistance: concrete C 20/25 – $f_{ck,cube} = 25 \text{ N/mm}^2$, anchor rebar BSt 500 S

		ETA-04/0027, issue issue 2013-06-26 for diamond drilling								
Anchor size		Ø8	Ø10	Ø12	Ø14	Ø16	Ø20	Ø25	Ø28	32
Tensile $N_{Ru,m}$	BSt 500 S [kN]	24,1	33,9	49,8	51,8	69,1	106,8	134,6	183,2	197,9
Shear $V_{Ru,m}$	BSt 500 S [kN]	14,0	22,0	31,0	42,0	55,0	86,0	135,0	169,0	221,0

Design resistance: concrete C 20/25 – $f_{ck,cube} = 25 \text{ N/mm}^2$, anchor rebar BSt 500 S

		ETA-04/0027, issue issue 2013-06-26 for diamond drilling								
Anchor size		Ø8	Ø10	Ø12	Ø14	Ø16	Ø20	Ø25	Ø28	32
Tensile $N_{Ru,m}$	BSt 500 S [kN]	13,4	18,9	27,7	28,8	32,9	50,9	64,09	87,3	94,3
Shear $V_{Ru,m}$	BSt 500 S [kN]	9,3	14,67	20,7	28,0	36,7	57,3	90,0	112,7	147,3

Recommended loads ^{a)}: concrete C 20/25 – $f_{ck,cube} = 25 \text{ N/mm}^2$, anchor rebar BSt 500 S

		ETA-04/0027, issue issue 2013-06-26 for diamond drilling								
Anchor size		Ø8	Ø10	Ø12	Ø14	Ø16	Ø20	Ø25	Ø28	32
Tensile $N_{Ru,m}$	BSt 500 S [kN]	9,6	13,5	19,8	20,6	23,5	36,3	45,8	62,3	67,3
Shear $V_{Ru,m}$	BSt 500 S [kN]	6,7	10,5	14,8	20,0	26,2	41,0	64,3	80,5	105,2

a) With overall partial safety factor for action $\gamma = 1,4$. The partial safety factors for action depend on the type of loading and shall be taken from national regulations.

Service temperature range

Hilti HIT-RE 500 injection mortar may be applied in the temperature ranges given below. An elevated base material temperature may lead to a reduction of the design bond resistance.

Temperature range	Base material temperature	Maximum long term base material temperature	Maximum short term base material temperature
Temperature range I	-40 °C to +40 °C	+24 °C	+40 °C
Temperature range II	-40 °C to +58 °C	+35 °C	+58 °C
Temperature range III	-40 °C to +70 °C	+43 °C	+70 °C

Max short term base material temperature

Short-term elevated base material temperatures are those that occur over brief intervals, e.g. as a result of diurnal cycling.

Max long term base material temperature

Long-term elevated base material temperatures are roughly constant over significant periods of time.

Materials

Mechanical properties of rebar BSt 500S

			Data according ETA-04/0027, issue 2013-06-26									Additional Hilti tech. data	
Anchor size			Ø8	Ø10	Ø12	Ø14	Ø16	Ø20	Ø25	Ø28	Ø32	Ø36	Ø40
Nominal tensile strength f_{uk}	BSt 500 S	[N/mm ²]	550	550	550	550	550	550	550	550	550	550	550
Yield strength f_{yk}	BSt 500 S	[N/mm ²]	500	500	500	500	500	500	500	500	500	500	500
Stressed cross-section A_s	BSt 500 S	[mm ²]	50,3	78,5	113,1	153,9	201,1	314,2	490,9	615,8	804,2	1018	1257
Moment of resistance W	BSt 500 S	[mm ³]	50,3	98,2	169,6	269,4	402,1	785,4	1534	2155	3217	4580	6283

Material quality

Part	Material
rebar BSt 500 S	Geometry and mechanical properties according to DIN 488-2:1986 or E DIN 488-2:2006

Setting

installation equipment

Anchor size	Ø8	Ø10	Ø12	Ø14	Ø16	Ø20	Ø25	Ø28	Ø32	Ø36
Rotary hammer	TE 2 – TE 16					TE 40 – TE 70				
Other tools	compressed air gun or blow out pump, set of cleaning brushes, dispenser									

Setting instruction

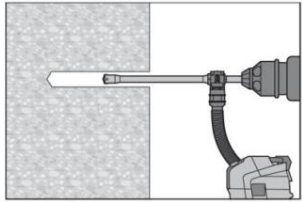
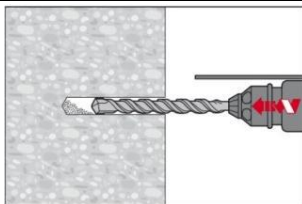
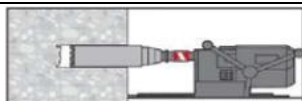
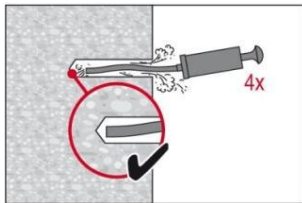
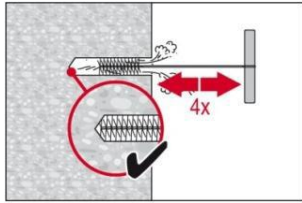
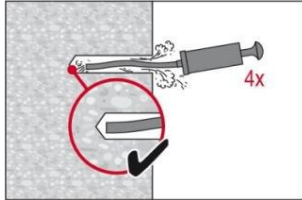
Bore hole drilling	
a) Hilti hollow drill bit	(for dry and wet concrete only)
	Drill hole to the required embedment depth with an appropriately sized Hilti TE-CD or TE-YD hollow drill bit with Hilti vacuum attachment. This drilling system removes the dust and cleans the bore hole during drilling when used in accordance with the user's manual. After drilling is complete, proceed to the "injection preparation" step in the instructions for use.
b) Hammer drilling	(dry or wet concrete and installation in flooded holes (no sea water))
	Drill Hole to the required embedment depth with a hammer drill set in rotation-hammer mode using an appropriately sized carbide drill bit.
c) Diamond coring	(for dry and wet concrete only)
	Diamond coring is permissible when diamond core drilling machine and the corresponding core bit are used.
Bore hole cleaning Just before setting an anchor, the bore hole must be free of dust and debris.	
a) Manual Cleaning (MC) non-cracked concrete only for bore hole diameters $d_0 \leq 20\text{mm}$ and bore hole depth $h_0 \leq 20d$ or $h_0 \leq 250\text{ mm}$ ($d = \text{diameter of element}$)	
	The Hilti manual pump may be used for blowing out bore holes up to diameters $d_0 \leq 20\text{ mm}$ and embedment depths up to $h_{ef} \leq 10d$. Blow out at least 4 times from the back of the bore hole until return air stream is free of noticeable dust
	Brush 4 times with the specified brush size (brush diameter \geq bore hole) by inserting the steel brush Hilti HIT-RB to the back of the hole (if needed with extension) in a twisting motion and removing it. The brush must produce natural resistance as it enters the bore hole - if not the brush is too small and must be replaced with the proper brush diameter.
	Blow out again with manual pump at least 4 times until return air stream is free of noticeable dust.

b) Compressed air cleaning (CAC)

for all bore hole diameters d_0 and all bore hole depth h_0

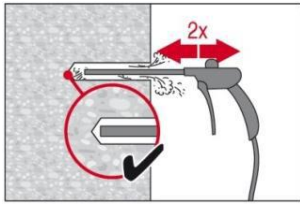

Blow 2 times from the back of the hole (if needed with nozzle extension) over the hole length with oil-free compressed air (min. 6 bar at 6 m³/h) until return air stream is free of noticeable dust.

Bore hole diameter ≥ 32 mm the compressor must supply a minimum air flow of 140 m³/hour.

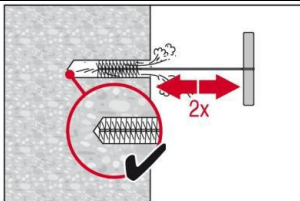

Brush 2 times with the specified brush size by inserting the steel brush Hilti HIT-RB to the back of the hole (if needed with extension) in a twisting motion and removing it.

The brush must produce natural resistance as it enters the bore hole - if not the brush is too small and must be replaced with the proper brush diameter.

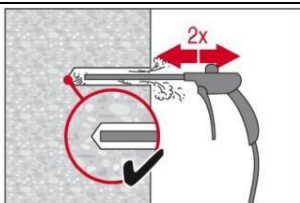

Blow again with compressed air 2 times until return air stream is free of noticeable dust.

c) Cleaning for under water

for all bore hole diameters d_0 and all bore hole depth h_0

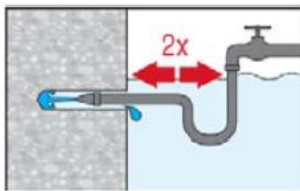

Flush 2 times the hole by inserting a water hose (water-line pressure) to the back of the hole until water runs clear.

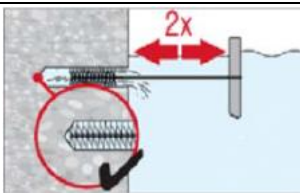

Brush 2 times with the specified brush size by inserting the steel brush Hilti HIT-RB to the back of the hole (if needed with extension) in a twisting motion and removing it.

The brush must produce natural resistance as it enters the bore hole - if not the brush is too small and must be replaced with the proper brush diameter.

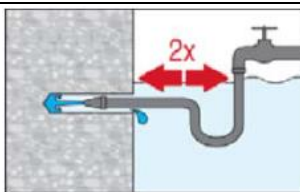

Flush again 2 times the hole by inserting a water hose (water-line pressure) to the back of the hole until water runs clear.

d) Cleaning of hammer drilled holes and diamond cored holes

for all bore hole diameters d_0 and all bore hole depth h_0

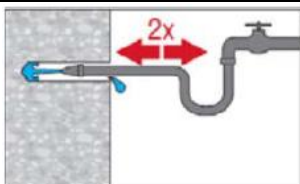

Flush 2 times the hole by inserting a water hose (water-line pressure) to the back of the hole until water runs clear.

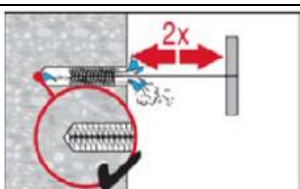

Brush 2 times with the specified brush size by inserting the steel brush Hilti HIT-RB to the back of the hole (if needed with extension) in a twisting motion and removing it.

The brush must produce natural resistance as it enters the bore hole - if not the brush is too small and must be replaced with the proper brush diameter.

	<p>Flush again 2 times the hole by inserting a water hose (water-line pressure) to the back of the hole until water runs clear.</p>
	<p>Blow 2 times from the back of the hole (if needed with nozzle extension) over the hole length with oil-free compressed air (min. 6 bar at 6 m³/h) until return air stream is free of noticeable dust and water.</p> <p>Bore hole diameter ≥ 32 mm the compressor must supply a minimum air flow of 140 m³/hour.</p>
	<p>Brush 2 times with the specified brush size by inserting the steel brush Hilti HIT-RB to the back of the hole (if needed with extension) in a twisting motion and removing it.</p> <p>The brush must produce natural resistance as it enters the bore hole - if not the brush is too small and must be replaced with the proper brush diameter.</p>
	<p>Blow again with compressed air 2 times until return air stream is free of noticeable dust and water.</p>
<p>Injection preparation</p>	
	<p>Tightly attach new Hilti mixing nozzle HIT-RE-M to foil pack manifold (snug fit). Do not modify the mixing nozzle. Observe the instruction for use of the dispenser and mortar.</p> <p>Check foil pack holder for proper function. Do not use damaged foil packs / holders.</p> <p>Insert foil pack into foil pack holder and put holder into HIT-dispenser.</p>
	<p>The foil pack opens automatically as dispensing is initiated. Discard initial adhesive. Depending on the size of the foil pack an initial amount of adhesive has to be discarded.</p> <p>Discard quantities are:</p> <ul style="list-style-type: none"> 2 strokes for 330 ml foil pack, 3 strokes for 500 ml foil pack, 65 ml for 1400 ml foil pack.

Inject adhesive from the back of the borehole without forming air voids

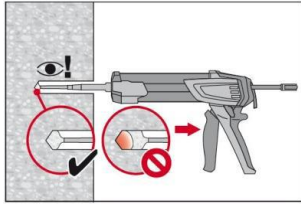

Inject the adhesive starting at the back of the hole, slowly withdrawing the mixer with each trigger pull. Fill holes approximately 2/3 full. It is required that the annular gap between the anchor and the concrete is completely filled with adhesive along the embedment length.

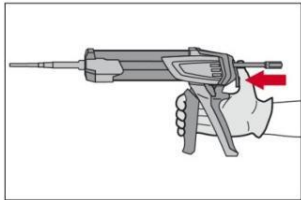

After injection is completed, depressurize the dispenser by pressing the release trigger. This will prevent further adhesive discharge from the mixer.

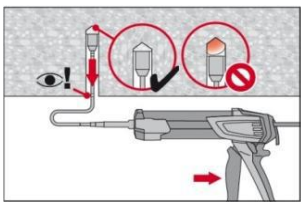

Overhead installation and/or installation with embedment depth $h_{ef} > 250\text{mm}$.

For overhead installation the injection is only possible with the aid of extensions and piston plugs. Assemble HIT-RE-M mixer, extension(s) and appropriately sized piston plug HIT-SZ. Insert piston plug to back of the hole and inject adhesive. During injection the piston plug will be naturally extruded out of the bore hole by the adhesive pressure.

Under water application: fill borehole completely with mortar.

Setting the element

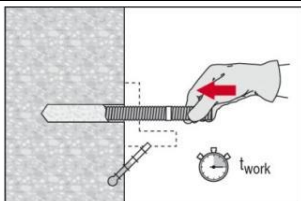

Before use, verify that the element is dry and free of oil and other contaminants. Mark and set element to the required embedment depth until working time t_{work} has elapsed.

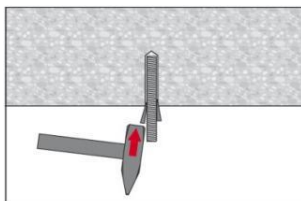

For overhead installation use piston plugs and fix embedded parts with e.g. wedges HIT-OHW.

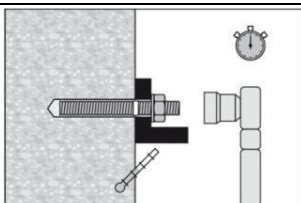

Loading the anchor:
After required curing time t_{cure} the anchor can be loaded.
The applied installation torque shall not exceed T_{max} .

For detailed information on installation see instruction for use given with the package of the product.

Curing time for general conditions

Data according ETA-04/0027, issue 2013-06-26			Additional Hilti technical data
Temperature of the base material	Working time in which anchor can be inserted and adjusted t_{gel}	Curing time before anchor can be fully loaded t_{cure}	Preparation work may continue. Do not apply design load. $t_{cure, ini}$
40 °C	12 min	4 h	2 h
30 °C to 39 °C	12 min	8 h	4 h
20 °C to 29 °C	20 min	12 h	6 h
15 °C to 19 °C	30 min	24 h	8 h
10 °C to 14 °C	90 min	48 h	12 h
5 °C to 9 °C	120 min	72 h	18 h

For dry concrete curing times may be reduced according to the following table.
For installation temperatures below +5 °C all load values have to be reduced according to the load reduction factors given below.

Curing time for dry concrete

Additional Hilti technical data			
Temperature of the base material	Working time in which anchor can be inserted and adjusted t_{gel}	Reduced curing time before anchor can be fully loaded $t_{cure, dry}$	Load reduction factor
40 °C	12 min	4 h	1
30 °C	12 min	8 h	1
20 °C	20 min	12 h	1
15 °C	30 min	18 h	1
10 °C	90 min	24 h	1
5 °C	120 min	36 h	1
0 °C	3 h	50 h	0,7
-5 °C	4 h	72 h	0,6

Setting details

			Data according ETA-04/0027, issue 2013-06-26								Additional Hilti tech. data		
Anchor size			Ø8	Ø10	Ø12	Ø14	Ø16	Ø20	Ø25	Ø28	Ø32	Ø36	Ø40
Nominal diameter of drill bit	d_0	[mm]	12	14	16	18	20	25	32	35	40	45	55
Effective anchorage and drill hole depth range ^{a)}	$h_{ef,min}$	[mm]	60	60	70	75	80	90	100	112	128	144	160
	$h_{ef,max}$	[mm]	160	200	240	280	320	400	500	560	640	720	800
Minimum base material thickness	h_{min}	[mm]	$h_{ef} + 30 \text{ mm} \geq 100 \text{ mm}$		$h_{ef} + 2 d_0$								
Minimum spacing	s_{min}	[mm]	40	50	60	70	80	100	125	140	160	180	200
Minimum edge distance	c_{min}	[mm]	40	50	60	70	80	100	125	140	160	180	200
Critical spacing for splitting failure	$s_{cr,sp}$		$2 c_{cr,sp}$										
Critical edge distance for splitting failure ^{b)}	$c_{cr,sp}$	[mm]	$1,0 \cdot h_{ef}$ for $h / h_{ef} \geq 2,0$										
			$4,6 h_{ef} - 1,8 h$ for $2,0 > h / h_{ef} > 1,3$										
			$2,26 h_{ef}$ for $h / h_{ef} \leq 1,3$										
Critical spacing for concrete cone failure	$s_{cr,N}$		$2 c_{cr,N}$										
Critical edge distance for concrete cone failure ^{c)}	$c_{cr,N}$		$1,5 h_{ef}$										

For spacing (edge distance) smaller than critical spacing (critical edge distance) the design loads have to be reduced.

- a) $h_{ef,min} \leq h_{ef} \leq h_{ef,max}$ (h_{ef} : embedment depth)
- b) h : base material thickness ($h \geq h_{min}$)
- c) The critical edge distance for concrete cone failure depends on the embedment depth h_{ef} and the design bond resistance. The simplified formula given in this table is on the safe side.

Simplified design method

Simplified version of the design method according ETAG 001, TR 029. Design resistance according data given in ETA-04/0027, issue 2013-06-26.

- Influence of concrete strength
- Influence of edge distance
- Influence of spacing
- Valid for a group of two anchors. (The method may also be applied for anchor groups with more than two anchors or more than one edge distance. The influencing factors must then be considered for each edge distance and spacing. The calculated design loads are then on the same side: They will be lower than the exact values according ETAG 001, TR 029. To avoid this, it is recommended to use the anchor design software PROFIS anchor)

The design method is based on the following simplification:

- No different loads are acting on individual anchors (no eccentricity)

The values are valid for one anchor.

For more complex fastening applications please use the anchor design software PROFIS Anchor.

Tension loading

The design tensile resistance is the lower value of

- Steel resistance: $N_{Rd,s}$
- Combined pull-out and concrete cone resistance: $N_{Rd,p} = N_{Rd,p}^0 \cdot f_{B,p} \cdot f_{1,N} \cdot f_{2,N} \cdot f_{3,N} \cdot f_{h,p} \cdot f_{re,N}$
- Concrete cone resistance: $N_{Rd,c} = N_{Rd,c}^0 \cdot f_B \cdot f_{1,N} \cdot f_{2,N} \cdot f_{3,N} \cdot f_{h,N} \cdot f_{re,N}$
- Concrete splitting resistance (only non-cracked concrete): $N_{Rd,sp} = N_{Rd,c}^0 \cdot f_B \cdot f_{1,sp} \cdot f_{2,sp} \cdot f_{3,sp} \cdot f_{h,N} \cdot f_{re,N}$

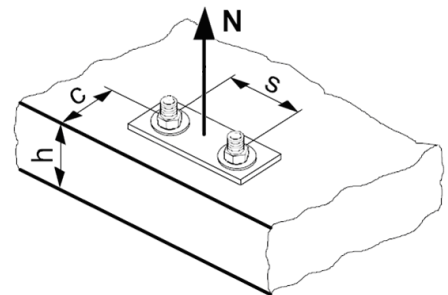

Basic design tensile resistance

Design steel resistance $N_{Rd,s}$

Anchor size	Data according ETA-04/0027, issue 2013-06-26										Additional Hilti tech. data	
	Ø8	Ø10	Ø12	Ø14	Ø16	Ø20	Ø25	Ø28	Ø32	Ø36	Ø40	
$N_{Rd,s}$ BSt 500 S [kN]	20,0	30,7	44,3	60,7	79,3	123,6	192,9	242,1	315,7	400	494	

Design combined pull-out and concrete cone resistance ^{a)}

$$N_{Rd,p} = N_{Rd,p}^0 \cdot f_{B,p} \cdot f_{1,N} \cdot f_{2,N} \cdot f_{3,N} \cdot f_{h,p} \cdot f_{re,N}$$

				Data according ETA-04/0027, issue 2013-06-26									Additional Hilti tech. data	
Anchor size				Ø8	Ø10	Ø12	Ø14	Ø16	Ø20	Ø25	Ø28	Ø32	Ø36	Ø40
Typical embedment depth $h_{ef,typ}$ [mm]				80	90	110	125	125	170	210	270	300	330	360
Hammer drilling + Hollow drill bit	$N_{Rd,p}^0$	Temp. range I	[kN]	14,4	20,2	29,6	36,7	41,9	71,2	102,1	147,0	186,7	192,8	216,1
	$N_{Rd,p}^0$	Temp. range II	[kN]	11,5	16,2	23,7	31,4	32,9	56,0	86,4	113,1	143,6	154,2	172,9
	$N_{Rd,p}^0$	Temp. range III	[kN]	6,7	9,4	13,8	18,3	20,9	33,1	51,1	67,9	86,2	92,5	103,7
Diamond coring	$N_{Rd,p}^0$	Temp. range I	[kN]	13,4	18,8	27,6	33,6	32,9	50,9	66,8	90,5	100,5	-	-
	$N_{Rd,p}^0$	Temp. range II	[kN]	10,6	14,9	21,9	27,5	25,4	40,7	55,0	73,5	79,0	-	-
	$N_{Rd,p}^0$	Temp. range III	[kN]	6,7	9,4	13,8	16,8	15,0	22,9	31,4	39,6	50,3	-	-

a) **Additional Hilti technical data (not part of ETA-04/0027, issue 2013-06-26):**

The design values for combined pull-out and concrete cone resistance may be increased by 20 % for anchor installation in dry concrete (concrete not in contact with water before/during installation and curing).

Design concrete cone resistance ^{a)} $N_{Rd,c} = N_{Rd,c}^0 \cdot f_B \cdot f_{1,N} \cdot f_{2,N} \cdot f_{3,N} \cdot f_{h,N} \cdot f_{re,N}$

Design splitting resistance $N_{Rd,sp} = N_{Rd,c}^0 \cdot f_B \cdot f_{1,sp} \cdot f_{2,sp} \cdot f_{3,sp} \cdot f_{h,N} \cdot f_{re,N}$

				Data according ETA-04/0027, issue 2013-06-26									Additional Hilti tech. data	
Anchor size				Ø8	Ø10	Ø12	Ø14	Ø16	Ø20	Ø25	Ø28	Ø32	Ø36	Ø40
$N_{Rd,c}^0$	[kN]			17,2	20,5	27,7	33,6	33,6	53,3	73,2	106,7	125,0	144,2	164,3

a) **Additional Hilti technical data (not part of ETA-04/0027, issue 2009-05-20):**

The design values for concrete cone and splitting resistance may be increased by 20 % for anchor installation in dry concrete (concrete not in contact with water before/during installation and curing).

Influencing factors

Influence of concrete strength on combined pull-out and concrete cone resistance

Concrete strength designation (ENV 206)	C 20/25	C 25/30	C 30/37	C 35/45	C 40/50	C 45/55	C 50/60
$f_{B,p} = (f_{ck,cube}/25N/mm^2)^{0,1}$ ^{a)}	1	1,02	1,04	1,06	1,07	1,08	1,09

a) $f_{ck,cube}$ = concrete compressive strength, measured on cubes with 150 mm side length

Influence of embedment depth on combined pull-out and concrete cone resistance

$$f_{h,p} = h_{ef}/h_{ef,typ}$$

Influence of concrete strength on concrete cone resistance

Concrete strength designation (ENV 206)	C 20/25	C 25/30	C 30/37	C 35/45	C 40/50	C 45/55	C 50/60
$f_B = (f_{ck,cube}/25N/mm^2)^{1/2}$ ^{a)}	1	1,1	1,22	1,34	1,41	1,48	1,55

a) $f_{ck,cube}$ = concrete compressive strength, measured on cubes with 150 mm side length

Influence of edge distance ^{a)}

$c/c_{cr,N}$	0,1	0,2	0,3	0,4	0,5	0,6	0,7	0,8	0,9	1
$c/c_{cr,sp}$										
$f_{1,N} = 0,7 + 0,3 \cdot c/c_{cr,N}$	0,73	0,76	0,79	0,82	0,85	0,88	0,91	0,94	0,97	1
$f_{1,sp} = 0,7 + 0,3 \cdot c/c_{cr,sp}$										
$f_{2,N} = 0,5 \cdot (1 + c/c_{cr,N})$	0,55	0,60	0,65	0,70	0,75	0,80	0,85	0,90	0,95	1
$f_{2,sp} = 0,5 \cdot (1 + c/c_{cr,sp})$										

a) The edge distance shall not be smaller than the minimum edge distance c_{min} given in the table with the setting details. These influencing factors must be considered for every edge distance smaller than the critical edge distance.

Influence of anchor spacing ^{a)}

$s/s_{cr,N}$	0,1	0,2	0,3	0,4	0,5	0,6	0,7	0,8	0,9	1
$s/s_{cr,sp}$										
$f_{3,N} = 0,5 \cdot (1 + s/s_{cr,N})$	0,55	0,60	0,65	0,70	0,75	0,80	0,85	0,90	0,95	1
$f_{3,sp} = 0,5 \cdot (1 + s/s_{cr,sp})$										

a) The anchor spacing shall not be smaller than the minimum anchor spacing s_{min} given in the table with the setting details. This influencing factor must be considered for every anchor spacing.

Influence of embedment depth on concrete cone resistance

$$f_{h,N} = (h_{ef}/h_{ef,typ})^{1,5}$$

Influence of reinforcement

h_{ef} [mm]	40	50	60	70	80	90	≥ 100
$f_{re,N} = 0,5 + h_{ef}/200mm \leq 1$	0,7 ^{a)}	0,75 ^{a)}	0,8 ^{a)}	0,85 ^{a)}	0,9 ^{a)}	0,95 ^{a)}	1

a) This factor applies only for dense reinforcement. If in the area of anchorage there is reinforcement with a spacing ≥ 150 mm (any diameter) or with a diameter ≤ 10 mm and a spacing ≥ 100 mm, then a factor $f_{re} = 1$ may be applied.

Shear loading

The design shear resistance is the lower value of

- Steel resistance: $V_{Rd,s}$
- Concrete pryout resistance: $V_{Rd,cp} = k \cdot \text{lower value of } N_{Rd,p} \text{ and } N_{Rd,c}$
- Concrete edge resistance: $V_{Rd,c} = V_{Rd,c}^0 \cdot f_B \cdot f_h \cdot f_4 \cdot f_{hef} \cdot f_c$

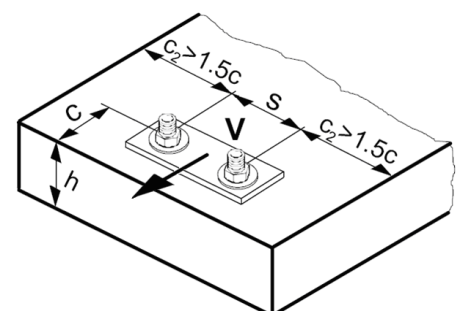

Basic design shear resistance

Design steel resistance $V_{Rd,s}$

Anchor size	Data according ETA-04/0027, issue 2013-06-26										Additional Hilti technical data	
	Ø8	Ø10	Ø12	Ø14	Ø16	Ø20	Ø25	Ø28	Ø32	Ø36	Ø40	
$V_{Rd,s}$ BSt 500 S [kN]	9,3	14,7	20,7	28,0	36,7	57,3	90,0	112,7	147,3	186,6	230,4	

Design concrete pryout resistance $V_{Rd,cp}$ = lower value^{a)} of $k \cdot N_{Rd,p}$ and $k \cdot N_{Rd,c}$

$$k = 2 \text{ for } h_{ef} \geq 60 \text{ mm}$$

- a) $N_{Rd,p}$: Design combined pull-out and concrete cone resistance
 $N_{Rd,c}$: Design concrete cone resistance

Design concrete edge resistance $V_{Rd,c} = V_{Rd,c}^0 \cdot f_B \cdot f_\beta \cdot f_h \cdot f_4 \cdot f_{hef} \cdot f_c$

Anchor size	Ø8	Ø10	Ø12	Ø14	Ø16	Ø20	Ø25	Ø28	Ø32	Ø36	Ø40
Non-cracked concrete											
$V_{Rd,c}^0$ [kN]	5,9	8,6	11,6	15,0	18,7	27,0	39,2	47,3	59,0	71,7	85,5

Influencing factors

Influence of concrete strength

Concrete strength designation (ENV 206)	C 20/25	C 25/30	C 30/37	C 35/45	C 40/50	C 45/55	C 50/60
$f_B = (f_{ck,cube}/25N/mm^2)^{1/2}$ a)	1	1,1	1,22	1,34	1,41	1,48	1,55

- a) $f_{ck,cube}$ = concrete compressive strength, measured on cubes with 150 mm side length

Influence of angle between load applied and the direction perpendicular to the free edge

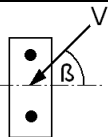
Angle β	0°	10°	20°	30°	40°	50°	60°	70°	80°	≥ 90°
$f_\beta = \frac{1}{\sqrt{(\cos \alpha_v)^2 + \left(\frac{\sin \alpha_v}{2,5}\right)^2}}$ 	1	1,01	1,05	1,13	1,24	1,40	1,64	1,97	2,32	2,50

Influence of base material thickness

h/c	0,15	0,3	0,45	0,6	0,75	0,9	1,05	1,2	1,35	≥ 1,5
$f_h = \{h/(1,5 \cdot c)\}^{1/2} \leq 1$	0,32	0,45	0,55	0,63	0,71	0,77	0,84	0,89	0,95	1,00

Influence of anchor spacing and edge distance ^{a)} for concrete edge resistance: f_4
 $f_4 = (c/h_{ef})^{1,5} \cdot (1 + s / [3 \cdot c]) \cdot 0,5$

c/h _{ef}	Single anchor	Group of two anchors s/h _{ef}														
		0,75	1,50	2,25	3,00	3,75	4,50	5,25	6,00	6,75	7,50	8,25	9,00	9,75	10,50	11,25
0,50	0,35	0,27	0,35	0,35	0,35	0,35	0,35	0,35	0,35	0,35	0,35	0,35	0,35	0,35	0,35	0,35
0,75	0,65	0,43	0,54	0,65	0,65	0,65	0,65	0,65	0,65	0,65	0,65	0,65	0,65	0,65	0,65	0,65
1,00	1,00	0,63	0,75	0,88	1,00	1,00	1,00	1,00	1,00	1,00	1,00	1,00	1,00	1,00	1,00	1,00
1,25	1,40	0,84	0,98	1,12	1,26	1,40	1,40	1,40	1,40	1,40	1,40	1,40	1,40	1,40	1,40	1,40
1,50	1,84	1,07	1,22	1,38	1,53	1,68	1,84	1,84	1,84	1,84	1,84	1,84	1,84	1,84	1,84	1,84
1,75	2,32	1,32	1,49	1,65	1,82	1,98	2,15	2,32	2,32	2,32	2,32	2,32	2,32	2,32	2,32	2,32
2,00	2,83	1,59	1,77	1,94	2,12	2,30	2,47	2,65	2,83	2,83	2,83	2,83	2,83	2,83	2,83	2,83
2,25	3,38	1,88	2,06	2,25	2,44	2,63	2,81	3,00	3,19	3,38	3,38	3,38	3,38	3,38	3,38	3,38
2,50	3,95	2,17	2,37	2,57	2,77	2,96	3,16	3,36	3,56	3,76	3,95	3,95	3,95	3,95	3,95	3,95
2,75	4,56	2,49	2,69	2,90	3,11	3,32	3,52	3,73	3,94	4,15	4,35	4,56	4,56	4,56	4,56	4,56
3,00	5,20	2,81	3,03	3,25	3,46	3,68	3,90	4,11	4,33	4,55	4,76	4,98	5,20	5,20	5,20	5,20
3,25	5,86	3,15	3,38	3,61	3,83	4,06	4,28	4,51	4,73	4,96	5,18	5,41	5,63	5,86	5,86	5,86
3,50	6,55	3,51	3,74	3,98	4,21	4,44	4,68	4,91	5,14	5,38	5,61	5,85	6,08	6,31	6,55	6,55
3,75	7,26	3,87	4,12	4,36	4,60	4,84	5,08	5,33	5,57	5,81	6,05	6,29	6,54	6,78	7,02	7,26
4,00	8,00	4,25	4,50	4,75	5,00	5,25	5,50	5,75	6,00	6,25	6,50	6,75	7,00	7,25	7,50	7,75
4,25	8,76	4,64	4,90	5,15	5,41	5,67	5,93	6,18	6,44	6,70	6,96	7,22	7,47	7,73	7,99	8,25
4,50	9,55	5,04	5,30	5,57	5,83	6,10	6,36	6,63	6,89	7,16	7,42	7,69	7,95	8,22	8,49	8,75
4,75	10,35	5,45	5,72	5,99	6,27	6,54	6,81	7,08	7,36	7,63	7,90	8,17	8,45	8,72	8,99	9,26
5,00	11,18	5,87	6,15	6,43	6,71	6,99	7,27	7,55	7,83	8,11	8,39	8,66	8,94	9,22	9,50	9,78
5,25	12,03	6,30	6,59	6,87	7,16	7,45	7,73	8,02	8,31	8,59	8,88	9,17	9,45	9,74	10,02	10,31
5,50	12,90	6,74	7,04	7,33	7,62	7,92	8,21	8,50	8,79	9,09	9,38	9,67	9,97	10,26	10,55	10,85

a) The anchor spacing and the edge distance shall not be smaller than the minimum anchor spacing s_{min} and the minimum edge distance c_{min} .

Influence of embedment depth

h _{ef} /d	4	4,5	5	6	7	8	9	10	11
f _{hef} = 0,05 · (h _{ef} / d) ^{1,68}	0,51	0,63	0,75	1,01	1,31	1,64	2,00	2,39	2,81
h _{ef} /d	12	13	14	15	16	17	18	19	20
f _{hef} = 0,05 · (h _{ef} / d) ^{1,68}	3,25	3,72	4,21	4,73	5,27	5,84	6,42	7,04	7,67

Influence of edge distance ^{a)}

c/d	4	6	8	10	15	20	30	40
f _c = (d / c) ^{0,19}	0,77	0,71	0,67	0,65	0,60	0,57	0,52	0,50

a) The edge distance shall not be smaller than the minimum edge distance c_{min} .

Combined tension and shear loading for hammer drilling or hollow drill bit

For combined tension and shear loading see section "Anchor Design".

Precalculated values

Recommended loads can be calculated by dividing the design resistance by an overall partial safety factor for action $\gamma = 1,4$. The partial safety factors for action depend on the type of loading and shall be taken from national regulations.

Design resistance: concrete C 20/25 – $f_{ck,cube} = 25 \text{ N/mm}^2$, Temperature range I

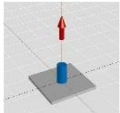
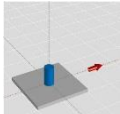
	Data according ETA-04/0027, issue 2013-06-26										Additional Hilti tech. data	
Anchor size	Ø8	Ø10	Ø12	Ø14	Ø16	Ø20	Ø25	Ø28	Ø32	Ø36	Ø40	
Embedment depth $h_{ef,1} =$ [mm]	60	60	72	84	96	120	150	168	192	216	240	
Base material thickness $h_{min} =$ [mm]	100	100	104	120	136	170	214	238	272	306	350	
 Tensile N_{Rd}: single anchor, no edge effects												
BSt 500 S [kN]	10,8	11,2	14,7	18,5	22,6	31,6	44,2	52,4	64,0	76,3	89,4	
 Shear V_{Rd}: single anchor, no edge effects, without lever arm												
BSt 500 S [kN]	9,3	14,7	20,7	28,0	36,7	57,3	90,0	112,7	147,3	186,6	230,4	

Design resistance: concrete C 20/25 – $f_{ck,cube} = 25 \text{ N/mm}^2$, Temperature range I

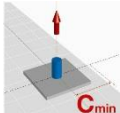
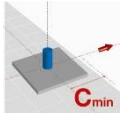
	Data according ETA-04/0027, issue 2013-06-26										Additional Hilti tech. data	
Anchor size	Ø8	Ø10	Ø12	Ø14	Ø16	Ø20	Ø25	Ø28	Ø32	Ø36	Ø40	
Embedment depth $h_{ef,1} =$ [mm]	60	60	72	84	96	120	150	168	192	216	240	
Base material thickness $h_{min} =$ [mm]	100	100	104	120	136	170	214	238	272	306	350	
Edge distance $c = c_{min} =$ [mm]	40	50	60	70	80	100	125	140	160	180	200	
 Tensile N_{Rd}: single anchor, min. edge distance ($c = c_{min}$)												
BSt 500 S [kN]	6,5	7,3	8,6	10,8	13,1	18,3	25,6	30,3	37,0	44,1	52,5	
 Shear V_{Rd}: single anchor, min. edge distance ($c = c_{min}$), without lever arm												
BSt 500 S [kN]	3,5	4,9	6,7	8,6	10,8	15,7	22,9	27,7	34,6	42,2	50,4	

Design resistance: concrete C 20/25 – $f_{ck,cube} = 25 \text{ N/mm}^2$, Temperature range I
(load values are valid for single anchor)

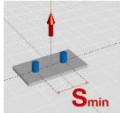
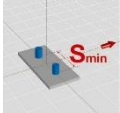
	Data according ETA-04/0027, issue 2013-06-26										Additional Hilti tech. data	
Anchor size	Ø8	Ø10	Ø12	Ø14	Ø16	Ø20	Ø25	Ø28	Ø32	Ø36	Ø40	
Embedment depth $h_{ef,1} =$ [mm]	60	60	72	84	96	120	150	168	192	216	240	
Base material thickness $h_{min} =$ [mm]	100	100	104	120	136	170	214	238	272	306	350	
Spacing $s = s_{min} =$ [mm]	40	50	60	70	80	100	125	140	160	180	200	
 Tensile N_{Rd}: double anchor, no edge effects, min. spacing ($s = s_{min}$)												
BSt 500 S [kN]	6,7	7,0	8,9	11,2	13,6	19,0	26,6	31,5	38,5	45,9	54,1	
 Shear V_{Rd}: double anchor, no edge effects, min. spacing ($s = s_{min}$), without lever arm												
BSt 500 S [kN]	9,3	14,7	20,7	28,0	36,7	56,5	79,0	93,7	114,4	136,6	159,9	

Design resistance: concrete C 20/25 – $f_{ck,cube} = 25 \text{ N/mm}^2$, Temperature range I

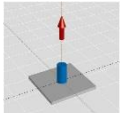
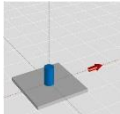
	Data according ETA-04/0027, issue 2013-06-26										Additional Hilti tech. data	
Anchor size	Ø8	Ø10	Ø12	Ø14	Ø16	Ø20	Ø25	Ø28	Ø32	Ø36	Ø40	
Embedment depth $h_{ef,typ} =$ [mm]	80	90	110	125	125	170	210	270	300	330	360	
Base material thickness $h_{min} =$ [mm]	110	120	142	161	165	220	274	340	380	420	470	
 Tensile N_{Rd}: single anchor, no edge effects												
BSt 500 S [kN]	14,4	20,2	27,7	33,6	33,6	53,3	73,2	106,7	125,0	144,2	164,3	
 Shear V_{Rd}: single anchor, no edge effects, without lever arm												
BSt 500 S [kN]	9,3	14,7	20,7	28,0	36,7	57,3	90,0	112,7	147,3	186,6	230,4	

Design resistance: concrete C 20/25 – $f_{ck,cube} = 25 \text{ N/mm}^2$, Temperature range I

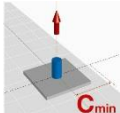
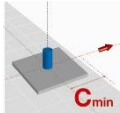
	Data according ETA-04/0027, issue 2013-06-26										Additional Hilti tech. data	
Anchor size	Ø8	Ø10	Ø12	Ø14	Ø16	Ø20	Ø25	Ø28	Ø32	Ø36	Ø40	
Embedment depth $h_{ef,typ} =$ [mm]	80	90	110	125	125	170	210	270	300	330	360	
Base material thickness $h_{min} =$ [mm]	110	120	142	161	165	220	274	340	380	420	470	
Edge distance $c = c_{min} =$ [mm]	40	50	60	70	80	100	125	140	160	180	200	
 Tensile N_{Rd}: single anchor, min. edge distance ($c = c_{min}$)												
BSt 500 S [kN]	7,8	10,0	13,3	16,2	17,0	26,1	36,1	50,4	59,5	69,1	79,3	
 Shear V_{Rd}: single anchor, min. edge distance ($c = c_{min}$), without lever arm												
BSt 500 S [kN]	3,7	5,3	7,3	9,5	11,5	17,2	25,0	31,6	39,3	47,8	56,9	

Design resistance: concrete C 20/25 – $f_{ck,cube} = 25 \text{ N/mm}^2$, Temperature range I
(load values are valid for single anchor)

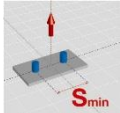
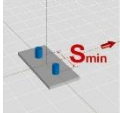
	Data according ETA-04/0027, issue 2013-06-26										Additional Hilti tech. data	
Anchor size	Ø8	Ø10	Ø12	Ø14	Ø16	Ø20	Ø25	Ø28	Ø32	Ø36	Ø40	
Embedment depth $h_{ef,typ} =$ [mm]	80	90	110	125	125	170	210	270	300	330	360	
Base material thickness $h_{min} =$ [mm]	110	120	142	161	165	220	274	340	380	420	470	
Spacing $s = s_{min} =$ [mm]	40	50	60	70	80	100	125	140	160	180	200	
 Tensile N_{Rd}: double anchor, no edge effects, min. spacing ($s = s_{min}$)												
BSt 500 S [kN]	8,9	11,6	15,5	18,9	19,2	30,1	41,4	59,5	69,8	80,8	92,3	
 Shear V_{Rd}: double anchor, no edge effects, min. spacing ($s = s_{min}$), without lever arm												
BSt 500 S [kN]	9,3	14,7	20,7	28,0	36,7	57,3	90,0	112,7	147,3	186,6	230,4	

Design resistance: concrete C 20/25 – $f_{ck,cube} = 25 \text{ N/mm}^2$, Temperature range I

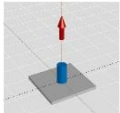
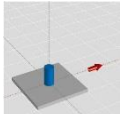
		Data according ETA-04/0027, issue 2013-06-26										Additional Hilti tech. data	
Anchor size		Ø8	Ø10	Ø12	Ø14	Ø16	Ø20	Ø25	Ø28	Ø32	Ø36	Ø40	
Embedment depth	$h_{ef,2} = [\text{mm}]$	96	120	144	168	192	240	300	336	384	432	480	
Base material thickness	$h_{min} = [\text{mm}]$	126	150	176	204	232	290	364	406	464	522	590	
	Tensile N_{Rd}: single anchor, no edge effects												
BSt 500 S	[kN]	17,2	26,9	38,8	49,3	64,0	89,4	125,0	148,1	181,0	215,9	252,9	
	Shear V_{Rd}: single anchor, no edge effects, without lever arm												
BSt 500 S	[kN]	9,3	14,7	20,7	28,0	36,7	57,3	90,0	112,7	147,3	186,6	230,4	



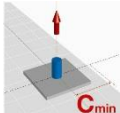
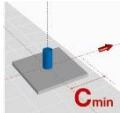

Design resistance: concrete C 20/25 – $f_{ck,cube} = 25 \text{ N/mm}^2$, Temperature range I

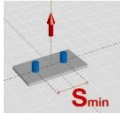
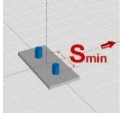
		Data according ETA-04/0027, issue 2013-06-26										Additional Hilti tech. data	
Anchor size		Ø8	Ø10	Ø12	Ø14	Ø16	Ø20	Ø25	Ø28	Ø32	Ø36	Ø40	
Embedment depth	$h_{ef,2} = [\text{mm}]$	96	120	144	168	192	240	300	336	384	432	480	
Base material thickness	$h_{min} = [\text{mm}]$	126	150	176	204	232	290	364	406	464	522	590	
Edge distance	$c = c_{min} = [\text{mm}]$	40	50	60	70	80	100	125	140	160	180	200	
	Tensile N_{Rd}: single anchor, min. edge distance ($c = c_{min}$)												
BSt 500 S	[kN]	9,4	14,1	18,6	23,4	28,6	40,0	55,9	66,2	80,9	96,6	113,1	
	Shear V_{Rd}: single anchor, min. edge distance ($c = c_{min}$), without lever arm												
BSt 500 S	[kN]	3,9	5,7	7,8	10,2	12,9	18,9	27,8	33,9	42,6	52,3	62,7	

Design resistance: concrete C 20/25 – $f_{ck,cube} = 25 \text{ N/mm}^2$, Temperature range I
(load values are valid for single anchor)

		Data according ETA-04/0027, issue 2013-06-26										Additional Hilti tech. data	
Anchor size		Ø8	Ø10	Ø12	Ø14	Ø16	Ø20	Ø25	Ø28	Ø32	Ø36	Ø40	
Embedment depth	$h_{ef,2} = [\text{mm}]$	96	120	144	168	192	240	300	336	384	432	480	
Base material thickness	$h_{min} = [\text{mm}]$	126	150	176	204	232	290	364	406	464	522	590	
Spacing	$s = s_{min} = [\text{mm}]$	40	50	60	70	80	100	125	140	160	180	200	
	Tensile N_{Rd}: double anchor, no edge effects, min. spacing ($s = s_{min}$)												
BSt 500 S	[kN]	10,9	16,6	22,7	28,6	34,9	48,8	68,2	80,9	98,8	117,9	138,1	
	Shear V_{Rd}: double anchor, no edge effects, min. spacing ($s = s_{min}$), without lever arm												
BSt 500 S	[kN]	9,3	14,7	20,7	28,0	36,7	57,3	90,0	112,7	147,3	186,6	230,4	

Hilti HIT-HY 200 mortar with HIT-Z rod

Injection mortar system		Benefits
	Hilti HIT-HY 200-A 500 ml foil pack (also available as 330 ml foil pack)	<ul style="list-style-type: none"> - SAFEset technology: drilling and installing the HIT-Z rod without borehole cleaning - unmatched seismic performance with the highest ETA C1 and C2 approvals - maximum load performance in cracked concrete and uncracked concrete - suitable for cracked and non-cracked concrete C 20/25 to C 50/60 - suitable for use with diamond cored holes in non-cracked or cracked concrete with no load reductions - two mortar (Hilti HIT-HY 200-A and Hilti HIT-HY 200-R) versions available with different curing times and same performance
	Hilti HIT-HY 200-R 500 ml foil pack (also available as 330 ml foil pack)	
	Static mixer	
	HIT-Z HIT-Z-R rod	



Concrete



Tensile zone



Seismic
ETA-C1/C2



Fire
resistance

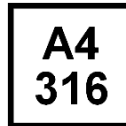

Corrosion
resistance

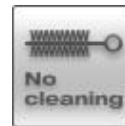

No cleaning
required for
approved loads

SAFEset

Hilti **SAFEset**
technology with
HIT-Z rod



European
Technical
Approval



CE
conformity



PROFIS
Anchor design
software

Approvals / certificates

Description	Authority / Laboratory	No. / date of issue
European technical approval ^{a)}	DIBt, Berlin	ETA-12/0006 / 2013-03-15 (HIT-HY 200-A) ETA-12/0028 / 2013-03-15 (HIT-HY 200-R)
Fire test report	IBMB, Brunswick	3501/676/13 / 2012-08-03

a) All data given in this section according ETA-12/0006 and ETA-12/0028, issue 2013-03-15.

Basic loading data (for a single anchor)

All data in this section applies to

For details see Simplified design method

- Correct setting (See setting instruction)
- No edge distance and spacing influence
- Steel failure
- Base material thickness, as specified in the table
- Embedment depth, as specified in the table
- One anchor material, as specified in the tables
- Concrete C 20/25, $f_{ck,cube} = 25 \text{ N/mm}^2$
- Temperature range I
(min. base material temperature -40°C , max. long term/short term base material temperature: $+24^\circ\text{C}/40^\circ\text{C}$)
- Installation temperature range $+5^\circ\text{C}$ to $+40^\circ\text{C}$

Embedment depth and base material thickness for the basic loading data. Mean ultimate resistance, characteristic resistance, design resistance, recommended loads.

Anchor size	M8	M10	M12	M16	M20
Typical embedment depth [mm]	70	90	110	145	180
Base material thickness [mm]	130	150	170	245	280

Mean ultimate resistance: concrete C 20/25 – $f_{ck,cube} = 25 \text{ N/mm}^2$, element HIT-Z

Anchor size	M8	M10	M12	M16	M20
Non-cracked concrete					
Tensile $N_{Ru,m}$ HIT-Z [kN]	25,2	39,9	57,8	100,8	153,3
Shear $V_{Ru,m}$ HIT-Z [kN]	12,6	20,0	28,4	50,4	76,7
Cracked concrete					
Tensile $N_{Ru,m}$ HIT-Z [kN]	25,2	39,9	55,1	83,4	115,4
Shear $V_{Ru,m}$ HIT-Z [kN]	12,6	20,0	28,4	50,4	76,7

Characteristic resistance: concrete C 20/25 – $f_{ck,cube} = 25 \text{ N/mm}^2$, element HIT-Z

Anchor size	M8	M10	M12	M16	M20
Non-cracked concrete					
Tensile N_{Rk} HIT-Z [kN]	24,0	38,0	54,3	88,2	122,0
Shear V_{Rk} HIT-Z [kN]	12,0	19,0	27,0	48,0	73,0
Cracked concrete					
Tensile N_{Rk} HIT-Z [kN]	21,1	30,7	41,5	62,9	86,9
Shear V_{Rk} HIT-Z [kN]	12,0	19,0	27,0	48,0	73,0

Design resistance: concrete C 20/25 – $f_{ck,cube} = 25 \text{ N/mm}^2$, element HIT-Z

Anchor size	M8	M10	M12	M16	M20
Non-cracked concrete					
Tensile N_{Rd} HIT-Z [kN]	16,0	25,3	36,2	58,8	81,3
Shear V_{Rd} HIT-Z [kN]	9,6	15,2	21,6	38,4	58,4
Cracked concrete					
Tensile N_{Rd} HIT-Z [kN]	14,1	20,5	27,7	41,9	58,0
Shear V_{Rd} HIT-Z [kN]	9,6	15,2	21,6	38,4	58,4

Recommended loads ^{a)}: concrete C 20/25 – $f_{ck,cube} = 25 \text{ N/mm}^2$, element HIT-Z

Anchor size			M8	M10	M12	M16	M20
Non-cracked concrete							
Tensile N_{rec}	HIT-Z	[kN]	11,4	18,1	25,9	42,0	58,1
Shear V_{rec}	HIT-Z	[kN]	6,9	10,9	15,4	27,4	41,7
Cracked concrete							
Tensile N_{rec}	HIT-Z	[kN]	10,0	14,6	19,8	29,9	41,4
Shear V_{rec}	HIT-Z	[kN]	6,9	10,9	15,4	27,4	41,7

a) With overall partial safety factor for action $\gamma = 1,4$. The partial safety factors for action depend on the type of loading and shall be taken from national regulations.

Service temperature range

Hilti HIT-HY 200 injection mortar with anchor rod HIT-Z may be applied in the temperature ranges given below. An elevated base material temperature leads to a reduction of the design bond resistance.

Temperature range	Base material temperature	Maximum long term base material temperature	Maximum short term base material temperature
Temperature range I	-40 °C to +40 °C	+24 °C	+40 °C
Temperature range II	-40 °C to +80 °C	+40 °C	+80 °C
Temperature range III	-40 °C to +120 °C	+72 °C	+120 °C

Max short term base material temperature

Short-term elevated base material temperatures are those that occur over brief intervals, e.g. as a result of diurnal cycling.

Max long term base material temperature

Long-term elevated base material temperatures are roughly constant over significant periods of time.

Materials

Mechanical properties of HIT-Z and HIT-Z-R

Anchor size			M8	M10	M12	M16	M20
Nominal tensile strength f_{uk}	HIT-Z	[N/mm ²]	650	650	650	610	595
	HIT-Z-R						
Yield strength f_{yk}	HIT-Z	[N/mm ²]	520	520	520	490	480
	HIT-Z-R						
Stressed cross-section of thread A_s	HIT-Z	[mm ²]	36,6	58,0	84,3	157	245
Moment of resistance W	HIT-Z	[mm ³]	31,9	62,5	109,7	278	542

Material quality

Part	Material
HIT-Z	C-steel cold formed, steel galvanized $\geq 5\mu\text{m}$
HIT-Z-R	stainless steel cold formed, A4

Anchor dimensions

Anchor size			M8	M10	M12	M16	M20
Length of anchor	min l	[mm]	80	95	105	155	215
	max l	[mm]	120	160	196	240	250
Helix length	l_{Helix}	[mm]	50	60	60	96	100

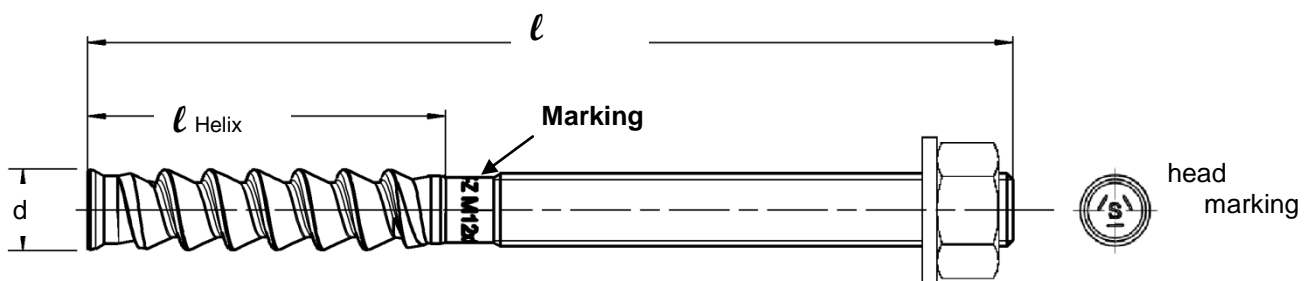

Installation equipment

Anchor size	M8	M10	M12	M16	M20
Rotary hammer	TE 2 – TE 40			TE 40 - TE 70	

Curing and working time

Temperature of the base material	HIT-HY 200-R	
	Working time in which anchor can be inserted and adjusted t_{work}	Curing time before anchor can be loaded t_{cure}
5 °C	1 hour	4 hour
6 °C to 10 °C	40 min	2,5 hour
11 °C to 20 °C	15 min	1,5 hour
21 °C to 30 °C	9 min	1 hour
31 °C to 40 °C	6 min	1 hour

Curing and working time

Temperature of the base material	HIT-HY 200-A	
	Working time in which anchor can be inserted and adjusted t_{work}	Curing time before anchor can be loaded t_{cure}
5 °C	25 min	2 hour
6 °C to 10 °C	15 min	75 min
11 °C to 20 °C	7 min	45 min
21 °C to 30 °C	4 min	30 min
31 °C to 40 °C	3 min	30 min

Setting instruction

Bore hole drilling

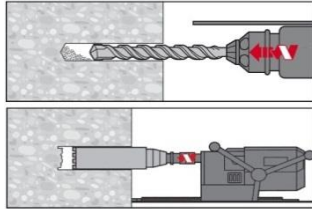

Pre-setting: Drill hole to the required drilling depth with a hammer drill set in rotation-hammer mode using an appropriately sized carbide drill bit. Diamond coring is permissible when diamond core drilling machine and the corresponding core bit are used.

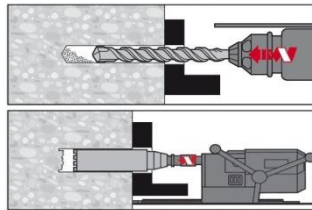

Through-setting: Drill hole through the clearance hole in the fixture to the required drilling depth with a hammer drill set in rotation-hammer mode using an appropriately sized carbide drill bit. Diamond coring is permissible when diamond core drilling machine and the corresponding core bit are used.

Bore hole cleaning^{a)}

a) No cleaning required for hammer drilled boreholes

b) Hole flushing and evacuation for wet-drilled diamond cored holes or flooded holes

Flush 2 times from the back of the hole over the hole length.

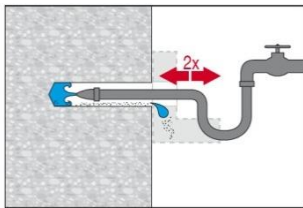

Blow 2 times the hole with oil-free compressed air (min. 6 bar at 6 m³/h) to evacuate the water

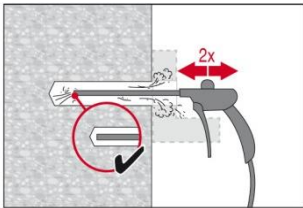

Check of setting depth and compress of the drilling dust

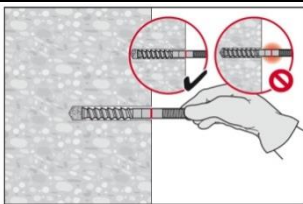

Mark the element and check the setting depth and compress the drilling dust. The element has to fit in the hole until the required embedment depth.

If it is not possible to compress the dust, remove the dust in the drill hole or drill deeper.

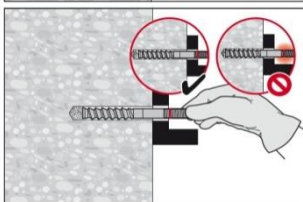

a) When drilling downward with non-cleaning the required drilling depths can vary due to accumulation of dust in the hole.

Injection preparation

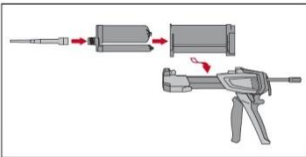

Tightly attach new Hilti mixing nozzle HIT-RE-M to foil pack manifold (snug fit). Do not modify the mixing nozzle. Observe the instruction for use of the dispenser.

Check foil pack holder for proper function. Do not use damaged foil packs / holders. Swing foil pack holder with foil pack into HIT-dispenser.

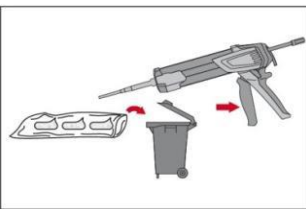

Discard initial adhesive. The foil pack opens automatically as dispensing is initiated. Depending on the size of the foil pack an initial amount of adhesive has to be discarded.

Discard quantities are

2 strokes for 330 ml foil pack

3 strokes for 500 ml foil pack

Inject adhesive from the back of the borehole without forming air voids

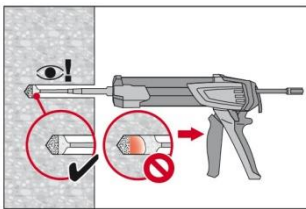

Inject the adhesive starting at the back of the hole, slowly withdrawing the mixer with each trigger pull.

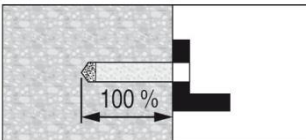
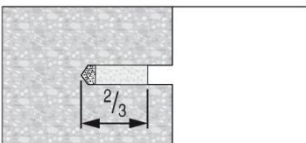

Fill holes approximately 2/3 full for Pre-setting and 100% full for through-setting, or as required to ensure that the annular gap between the anchor and the concrete is completely filled with adhesive along the embedment length.

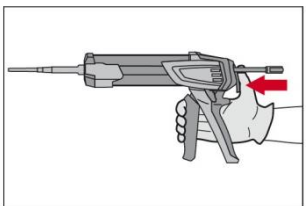

After injection is completed, depressurize the dispenser by pressing the release trigger. This will prevent further adhesive discharge from the mixer.

Overhead installation

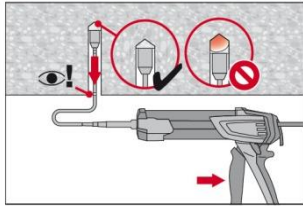

For overhead installation the injection is only possible with the aid of extensions and piston plugs. Assemble HIT-RE-M mixer, extension(s) and appropriately piston plug HIT-SZ. Insert piston plug to back of the hole and inject adhesive. During injection the piston plug will be naturally extruded out of the bore hole by the adhesive pressure

Setting the element

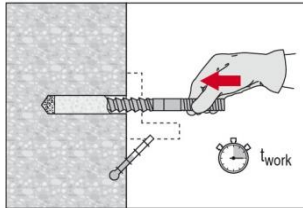

Before use, verify that the element is dry and free of oil and other contaminants. Set element to the required embedment depth until working time t_{work} has elapsed.
After setting the element the annular gap between the anchor and the fixture (through-setting) or concrete (pre-setting) has to be completely filled with mortar.

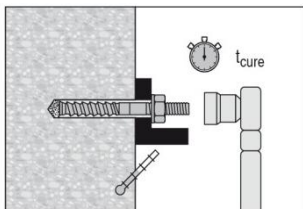

After required curing time t_{cure} remove excess mortar.
Apply indicated torque moment to activate anchor functioning principles.
The anchor can be loaded.

For detailed information on installation see instruction for use given with the package of the product.

Setting details

Anchor size		M8	M10	M12	M16	M20
Nominal diameter of drill bit	d_0 [mm]	10	12	14	18	22
Nominal embedment depth range	$h_{nom,min}$ [mm]	60	60	60	96	100
	$h_{nom,max}$ [mm]	100	120	150	200	220
Borehole condition 1 Minimum base material thickness	h_{min} [mm]	$h_{nom} + 60$ mm			$h_{nom} + 100$ mm	
Borehole condition 2 Minimum base material thickness	h_{min} [mm]	$h_{nom} + 30$ mm ≥ 100 mm			$h_{nom} + 45$ mm ≥ 45 mm	
Pre-setting: Diameter of clearance hole in the fixture	$d_f \leq$ [mm]	9	12	14	18	22
Through-setting: Diameter of clearance hole in the fixture	$d_f \leq$ [mm]	11	14	16	20	24
Torque moment	T_{inst} [Nm]	10	25	40	80	150

Critical edge distance and critical spacing

Critical spacing for splitting failure	$S_{cr,sp}$ [mm]	$2 C_{cr,sp}$
Critical edge distance for splitting failure	$C_{cr,sp}$ [mm]	$1,5 \cdot h_{nom}$ for $h / h_{nom} \geq 2,35$
		$6,2 h_{nom} - 2,0 h$ for $2,35 > h / h_{nom} > 1,35$
		$3,5 h_{nom}$ for $h / h_{nom} \leq 1,35$
Critical spacing for concrete cone failure	$S_{cr,N}$ [mm]	$2 C_{cr,N}$
Critical edge distance for concrete cone failure	$C_{cr,N}$ [mm]	$1,5 h_{nom}$

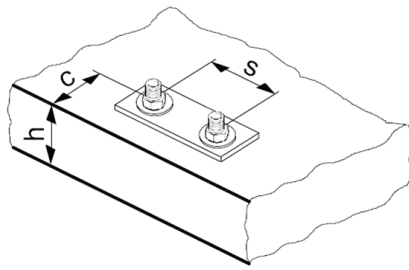
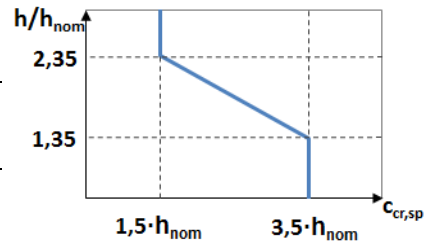

For spacing (or edge distance) smaller than critical spacing (or critical edge distance) the design loads have to be reduced.

a) Embedment depth range: $h_{nom,min} \leq h_{nom} \leq h_{nom,max}$

Pre-setting:
Install anchor before positioning fixture

Through-setting:
Install anchor through positioned fixture

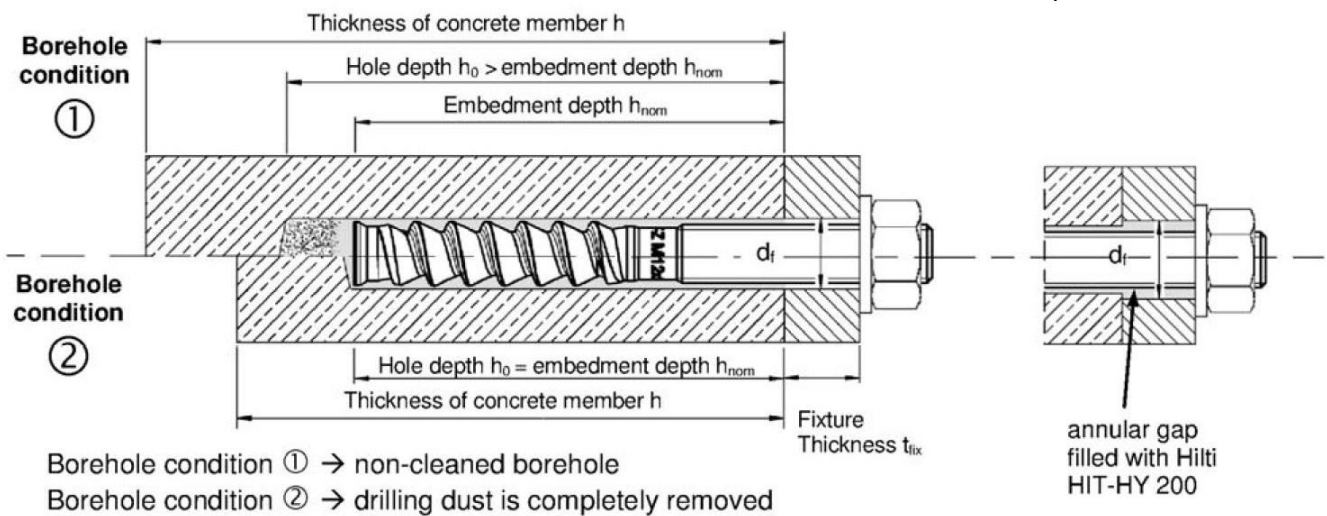

Minimum edge distance and spacing

For the calculation of minimum spacing and minimum edge distance of anchors in combination with different embedment depth and thickness of concrete member the following equation shall be fulfilled:

$$A_{i,req} < A_{i,cal}$$

Required interaction area $A_{i,req}$

Anchor size		M8	M10	M12	M16	M20
Cracked concrete	[mm ²]	19200	40800	58800	94700	148000
Uncracked concrete	[mm ²]	22200	57400	80800	128000	198000

Calculate interaction area $A_{i,cal}$

<p>Member thickness $h \geq h_{nom} + 1,5 \cdot c$</p>			
Single anchor and group of anchors with $s > 3 \cdot c$	[mm ²]	$A_{i,cal} = (6 \cdot c) \cdot (h_{nom} + 1,5 \cdot c)$	with $c \geq 5 \cdot d$
Group of anchors with $s \leq 3 \cdot c$	[mm ²]	$A_{i,cal} = (3 \cdot c + s) \cdot (h_{nom} + 1,5 \cdot c)$	with $c \geq 5 \cdot d$ and $s \geq 5 \cdot d$
<p>Member thickness $h \leq h_{nom} + 1,5 \cdot c$</p>			
Single anchor and group of anchors with $s > 3 \cdot c$	[mm ²]	$A_{i,cal} = (6 \cdot c) \cdot h$	with $c \geq 5 \cdot d$
Group of anchors with $s \leq 3 \cdot c$	[mm ²]	$A_{i,cal} = (3 \cdot c + s) \cdot h$	with $c \geq 5 \cdot d$ and $s \geq 5 \cdot d$

**Best case minimum edge distance and spacing
with required member thickness and embedment depth**

Anchor size		M8	M10	M12	M16	M20
Cracked concrete						
Member thickness	$h \geq$ [mm]	140	200	240	300	370
Embedment depth	$h_{nom} \geq$ [mm]	80	120	150	200	220
Minimum spacing	s_{min} [mm]	40	50	60	80	100
Corresponding edge distance	$c \geq$ [mm]	40	55	65	80	100
Minimum edge distance	$c_{min} =$ [mm]	40	50	60	80	100
Corresponding spacing	$s \geq$ [mm]	40	60	65	80	100
Non cracked concrete						
Member thickness	$h \geq$ [mm]	140	230	270	340	410
Embedment depth	$h_{nom} \geq$ [mm]	80	120	150	200	220
Minimum spacing	s_{min} [mm]	40	50	60	80	100
Corresponding edge distance	$c \geq$ [mm]	40	70	80	100	130
Minimum edge distance	c_{min} [mm]	40	50	60	80	100
Corresponding spacing	$s \geq$ [mm]	40	145	160	160	235

**Best case minimum member thickness and embedment depth
with required minimum edge distance and spacing (borehole condition 1)**

Anchor size		M8	M10	M12	M16	M20
Cracked concrete						
Member thickness	h_{min} [mm]	120	120	120	196	200
Embedment depth	$h_{nom,min}$ [mm]	60	60	60	96	100
Minimum spacing	s_{min} [mm]	40	50	60	80	100
Corresponding edge distance	$c \geq$ [mm]	40	100	140	135	215
Minimum edge distance	$c_{min} =$ [mm]	40	60	90	80	125
Corresponding spacing	$s \geq$ [mm]	40	160	220	235	365
Non cracked concrete						
Member thickness	h_{min} [mm]	120	120	120	196	200
Embedment depth	$h_{nom,min}$ [mm]	60	60	60	96	100
Minimum spacing	s_{min} [mm]	40	50	60	80	100
Corresponding edge distance	$c \geq$ [mm]	50	145	200	190	300
Minimum edge distance	c_{min} [mm]	40	80	115	110	165
Corresponding spacing	$s \geq$ [mm]	65	240	330	310	495

Minimum edge distance and spacing – Explanation

Minimum edge and spacing geometrical requirements are determined by testing the installation conditions in which two anchors with a given spacing can be set close to an edge without forming a crack in the concrete due to tightening torque.

The HIT-Z boundary conditions for edge and spacing geometry can be found in the tables to the left. If the embedment depth and slab thickness are equal to or greater than the values in the table, then the edge and spacing values may be utilized.

PROFIS Anchor software is programmed to calculate the referenced equations in order to determine the optimized related minimum edge and spacing based on the following variables:

Cracked or uncracked concrete	For cracked concrete it is assumed that a reinforcement is present which limits the crack width to 0,3 mm, allowing smaller values for minimum edge distance and minimum spacing
Anchor diameter	For smaller anchor diameter a smaller installation torque is required, allowing smaller values for minimum edge distance and minimum spacing
Slab thickness and embedment depth	Increasing these values allows smaller values for minimum edge distance and minimum spacing

Simplified design method

Simplified version of the design method according ETAG 001, TR 029. Design resistance according data given in ETA-12/0006 (HIT-HY 200-A) and ETA-12/0028 (HIT-HY 200-R) issued on 2013-03-15

- Influence of concrete strength
- Influence of edge distance
- Influence of spacing
- Valid for a group of two anchors. (The method may also be applied for anchor groups with more than two anchors or more than one edge distance. The influencing factors must then be considered for each edge distance and spacing. The simplified calculated design loads take a conservative approach: They will be lower than the exact values according to ETAG 001, TR 029. For an optimized design, anchor calculation can be performed using PROFIS anchor design software.

The design method is based on the following simplification:

- No different loads are acting on individual anchors (no eccentricity)

The values are valid for one anchor.

For more complex fastening applications please use the anchor design software PROFIS Anchor.

Tension loading

The design tensile resistance is the lower value of

- Steel resistance: $N_{Rd,s}$
- Combined pull-out and concrete cone resistance: $N_{Rd,p}$
- Concrete cone resistance: $N_{Rd,c} = N_{Rd,c}^0 \cdot f_B \cdot f_{1,N} \cdot f_{2,N} \cdot f_{3,N} \cdot f_{h,N} \cdot f_{re,N}$
- Concrete splitting resistance (only non-cracked concrete): $N_{Rd,sp} = N_{Rd,c}^0 \cdot f_B \cdot f_{1,sp} \cdot f_{2,sp} \cdot f_{3,sp} \cdot f_{h,N} \cdot f_{re,N}$

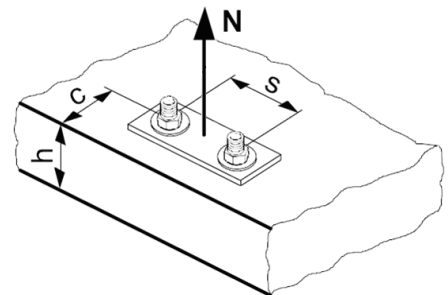

Basic design tensile resistance

Design steel resistance $N_{Rd,s}$

Anchor size		M8	M10	M12	M16	M20
$N_{Rd,s}$	HIT-Z / HIT-Z-R [kN]	16,0	25,3	36,7	64,0	97,3

Design combined pull-out and concrete cone resistance $N_{Rd,p}$ ^{a)}

Anchor size		M8	M10	M12	M16	M20
Non-cracked concrete						
$N_{Rd,p}^0$	Temperature range I [kN]	20,1	30,2	36,2	77,2	100,5
$N_{Rd,p}^0$	Temperature range II [kN]	18,4	27,6	33,2	70,8	92,2
$N_{Rd,p}^0$	Temperature range III [kN]	16,8	25,1	30,2	64,3	83,8
Cracked concrete						
$N_{Rd,p}^0$	Temperature range I [kN]	18,4	27,6	33,2	70,8	92,2
$N_{Rd,p}^0$	Temperature range II [kN]	16,8	25,1	30,2	64,3	83,8
$N_{Rd,p}^0$	Temperature range III [kN]	15,1	22,6	27,1	57,9	75,4

a) The combined pull-out and concrete cone resistance is independent from the embedment depth.

Design concrete cone resistance $N_{Rd,c} = N_{Rd,c}^0 \cdot f_B \cdot f_{1,N} \cdot f_{2,N} \cdot f_{3,N} \cdot f_{h,N} \cdot f_{re,N}$

Design splitting resistance ^{a)} $N_{Rd,sp} = N_{Rd,c}^0 \cdot f_B \cdot f_{1,sp} \cdot f_{2,sp} \cdot f_{3,sp} \cdot f_{h,N} \cdot f_{re,N}$

Anchor size		M8	M10	M12	M16	M20
$h_{nom,typ}$ [mm]		70	90	110	145	180
$N_{Rd,c}^0$ Non cracked concrete [kN]		19,7	28,7	38,8	58,8	81,3
$N_{Rd,c}^0$ Cracked concrete [kN]		14,1	20,5	27,7	41,9	58,0

a) Splitting resistance must only be considered for non-cracked concrete.

Influencing factors

Influence of concrete strength on combined pull-out and concrete cone resistance

Concrete strength designation (ENV 206)	C 20/25	C 25/30	C 30/37	C 35/45	C 40/50	C 45/55	C 50/60
$f_{B,p} =$	1,00	1,00	1,00	1,00	1,00	1,00	1,00

Influence of concrete strength on concrete cone resistance

Concrete strength designation (ENV 206)	C 20/25	C 25/30	C 30/37	C 35/45	C 40/50	C 45/55	C 50/60
$f_B = (f_{ck,cube}/25N/mm^2)^{0,5}$ ^{a)}	1	1,1	1,22	1,34	1,41	1,48	1,55

a) $f_{ck,cube}$ = concrete compressive strength, measured on cubes with 150 mm side length

Influence of edge distance ^{a)}

$c/c_{cr,N}$	0,1	0,2	0,3	0,4	0,5	0,6	0,7	0,8	0,9	1
$c/c_{cr,sp}$										
$f_{1,N} = 0,7 + 0,3 \cdot c/c_{cr,N} \leq 1$	0,73	0,76	0,79	0,82	0,85	0,88	0,91	0,94	0,97	1
$f_{1,sp} = 0,7 + 0,3 \cdot c/c_{cr,sp} \leq 1$										
$f_{2,N} = 0,5 \cdot (1 + c/c_{cr,N}) \leq 1$	0,55	0,60	0,65	0,70	0,75	0,80	0,85	0,90	0,95	1
$f_{2,sp} = 0,5 \cdot (1 + c/c_{cr,sp}) \leq 1$										

a) The edge distance shall not be smaller than the minimum edge distance c_{min} . These influencing factors must be considered for every edge distance smaller than the critical edge distance.

Influence of anchor spacing ^{a)}

$s/s_{cr,N}$	0,1	0,2	0,3	0,4	0,5	0,6	0,7	0,8	0,9	1
$s/s_{cr,sp}$										
$f_{3,N} = 0,5 \cdot (1 + s/s_{cr,N}) \leq 1$	0,55	0,60	0,65	0,70	0,75	0,80	0,85	0,90	0,95	1
$f_{3,sp} = 0,5 \cdot (1 + s/s_{cr,sp}) \leq 1$										

a) The anchor spacing shall not be smaller than the minimum anchor spacing s_{min} . This influencing factor must be considered for every anchor spacing.

Influence of embedment depth on concrete cone resistance

$f_{h,N} = (h_{nom}/h_{nom,typ})^{1,5}$

Influence of reinforcement

h_{nom} [mm]	60	70	80	90	≥ 100
$f_{re,N} = 0,5 + h_{nom}/200mm \leq 1$	0,8 ^{a)}	0,85 ^{a)}	0,9 ^{a)}	0,95 ^{a)}	1

a) This factor applies only for dense reinforcement. If in the area of anchorage there is reinforcement with a spacing ≥ 150 mm (any diameter) or with a diameter ≤ 10 mm and a spacing ≥ 100 mm, then a factor $f_{re,N} = 1$ may be applied.

Shear loading

The design shear resistance is the lower value of

- Steel resistance: $V_{Rd,s}$
- Concrete pryout resistance: $V_{Rd,cp} = k \cdot \text{lower value of } N_{Rd,p} \text{ and } N_{Rd,c}$
- Concrete edge resistance: $V_{Rd,c} = V_{Rd,c}^0 \cdot f_B \cdot f_{\beta} \cdot f_h \cdot f_4 \cdot f_{hef} \cdot f_c$

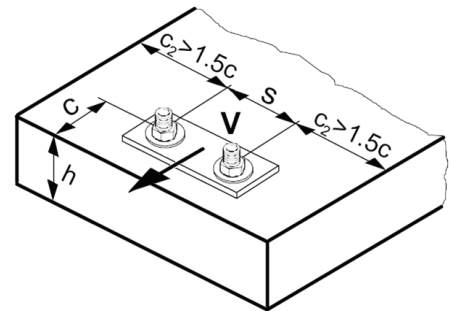

Basic design shear resistance

Design steel resistance $V_{Rd,s}$

Anchor size		M8	M10	M12	M16	M20
$V_{Rd,s}$ HIT-Z	[kN]	9,6	15,2	21,6	38,4	58,4
$V_{Rd,s}$ HIT-Z-R	[kN]	11,2	18,4	26,4	45,6	70,4

Design concrete pryout resistance $V_{Rd,cp}$ = lower value^{a)} of $k \cdot N_{Rd,p}$ and $k \cdot N_{Rd,c}$

$$k = 2 \text{ for } h_{ef} \geq 60 \text{ mm}$$

- a) $N_{Rd,p}$: Design combined pull-out and concrete cone resistance
 $N_{Rd,c}$: Design concrete cone resistance

Design concrete edge resistance^{a)} $V_{Rd,c} = V_{Rd,c}^0 \cdot f_B \cdot f_{\beta} \cdot f_h \cdot f_4$

Anchor size		Non-cracked concrete					Cracked concrete				
		M8	M10	M12	M16	M20	M8	M10	M12	M16	M20
$V_{Rd,c}^0$	[kN]	5,8	8,6	11,6	18,9	27,4	4,1	6,0	8,2	13,3	19,4

- a) For anchor groups only the anchors close to the edge must be considered.

Influencing factors

Influence of concrete strength

Concrete strength designation (ENV 206)	C 20/25	C 25/30	C 30/37	C 35/45	C 40/50	C 45/55	C 50/60
$f_B = (f_{ck,cube}/25N/mm^2)^{1/2}$ a)	1	1,1	1,22	1,34	1,41	1,48	1,55

- a) $f_{ck,cube}$ = concrete compressive strength, measured on cubes with 150 mm side length

Influence of angle between load applied and the direction perpendicular to the free edge

Angle β	0°	10°	20°	30°	40°	50°	60°	70°	80°	≥ 90°
$f_{\beta} = \frac{1}{\sqrt{(\cos \alpha_v)^2 + \left(\frac{\sin \alpha_v}{2,5}\right)^2}}$	1	1,01	1,05	1,13	1,24	1,40	1,64	1,97	2,32	2,50

Influence of base material thickness

h/c	0,15	0,3	0,45	0,6	0,75	0,9	1,05	1,2	1,35	≥ 1,5
$f_h = \{h/(1,5 \cdot c)\}^{1/2} \leq 1$	0,32	0,45	0,55	0,63	0,71	0,77	0,84	0,89	0,95	1,00

Influence of anchor spacing and edge distance ^{a)} for concrete edge resistance: f_4
 $f_4 = (c/h_{nom})^{1,5} \cdot (1 + s / [3 \cdot c]) \cdot 0,5$

c/h _{nom}	Single anchor	Group of two anchors s/h _{nom}														
		0,75	1,50	2,25	3,00	3,75	4,50	5,25	6,00	6,75	7,50	8,25	9,00	9,75	10,50	11,25
0,50	0,35	0,27	0,35	0,35	0,35	0,35	0,35	0,35	0,35	0,35	0,35	0,35	0,35	0,35	0,35	0,35
0,75	0,65	0,43	0,54	0,65	0,65	0,65	0,65	0,65	0,65	0,65	0,65	0,65	0,65	0,65	0,65	0,65
1,00	1,00	0,63	0,75	0,88	1,00	1,00	1,00	1,00	1,00	1,00	1,00	1,00	1,00	1,00	1,00	1,00
1,25	1,40	0,84	0,98	1,12	1,26	1,40	1,40	1,40	1,40	1,40	1,40	1,40	1,40	1,40	1,40	1,40
1,50	1,84	1,07	1,22	1,38	1,53	1,68	1,84	1,84	1,84	1,84	1,84	1,84	1,84	1,84	1,84	1,84
1,75	2,32	1,32	1,49	1,65	1,82	1,98	2,15	2,32	2,32	2,32	2,32	2,32	2,32	2,32	2,32	2,32
2,00	2,83	1,59	1,77	1,94	2,12	2,30	2,47	2,65	2,83	2,83	2,83	2,83	2,83	2,83	2,83	2,83
2,25	3,38	1,88	2,06	2,25	2,44	2,63	2,81	3,00	3,19	3,38	3,38	3,38	3,38	3,38	3,38	3,38
2,50	3,95	2,17	2,37	2,57	2,77	2,96	3,16	3,36	3,56	3,76	3,95	3,95	3,95	3,95	3,95	3,95
2,75	4,56	2,49	2,69	2,90	3,11	3,32	3,52	3,73	3,94	4,15	4,35	4,56	4,56	4,56	4,56	4,56
3,00	5,20	2,81	3,03	3,25	3,46	3,68	3,90	4,11	4,33	4,55	4,76	4,98	5,20	5,20	5,20	5,20
3,25	5,86	3,15	3,38	3,61	3,83	4,06	4,28	4,51	4,73	4,96	5,18	5,41	5,63	5,86	5,86	5,86
3,50	6,55	3,51	3,74	3,98	4,21	4,44	4,68	4,91	5,14	5,38	5,61	5,85	6,08	6,31	6,55	6,55
3,75	7,26	3,87	4,12	4,36	4,60	4,84	5,08	5,33	5,57	5,81	6,05	6,29	6,54	6,78	7,02	7,26
4,00	8,00	4,25	4,50	4,75	5,00	5,25	5,50	5,75	6,00	6,25	6,50	6,75	7,00	7,25	7,50	7,75
4,25	8,76	4,64	4,90	5,15	5,41	5,67	5,93	6,18	6,44	6,70	6,96	7,22	7,47	7,73	7,99	8,25
4,50	9,55	5,04	5,30	5,57	5,83	6,10	6,36	6,63	6,89	7,16	7,42	7,69	7,95	8,22	8,49	8,75
4,75	10,35	5,45	5,72	5,99	6,27	6,54	6,81	7,08	7,36	7,63	7,90	8,17	8,45	8,72	8,99	9,26
5,00	11,18	5,87	6,15	6,43	6,71	6,99	7,27	7,55	7,83	8,11	8,39	8,66	8,94	9,22	9,50	9,78
5,25	12,03	6,30	6,59	6,87	7,16	7,45	7,73	8,02	8,31	8,59	8,88	9,17	9,45	9,74	10,02	10,31
5,50	12,90	6,74	7,04	7,33	7,62	7,92	8,21	8,50	8,79	9,09	9,38	9,67	9,97	10,26	10,55	10,85

a) The anchor spacing and the edge distance shall not be smaller than the minimum anchor spacing s_{min} and the minimum edge distance c_{min} .

Influence of embedment depth

h _{nom} /d	4	4,5	5	6	7	8	9	10	11
$f_{hef} = 0,05 \cdot (h_{nom} / d)^{1,68}$	0,51	0,63	0,75	1,01	1,31	1,64	2,00	2,39	2,81
h _{ef} /d	12	13	14	15	16	17	18	19	20
$f_{hef} = 0,05 \cdot (h_{nom} / d)^{1,68}$	3,25	3,72	4,21	4,73	5,27	5,84	6,42	7,04	7,67

Influence of edge distance ^{a)}

c/d	4	6	8	10	15	20	30	40
$f_c = (d / c)^{0,19}$	0,77	0,71	0,67	0,65	0,60	0,57	0,52	0,50

a) The edge distance shall not be smaller than the minimum edge distance c_{min} .

Combined tension and shear loading

For combined tension and shear loading see section "Anchor Design".

Precalculated values – design resistance values

All data applies to:

- temperature range I (see service temperature range)
- no effects of dense reinforcement
- borehole condition 1

Recommended loads can be calculated by dividing the design resistance by an overall partial safety factor for action $\gamma = 1,4$. The partial safety factors for action depend on the type of loading and shall be taken from national regulations.

Design resistance: concrete C 20/25 – $f_{ck,cube} = 25 \text{ N/mm}^2$

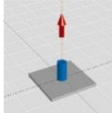
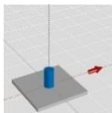
Anchor size	M8	M10	M12	M16	M20	
Embedment depth $h_{nom,min} =$ [mm]	60	60	60	96	100	
Base material thickness $h_{min} =$ [mm]	120	120	120	196	200	
	Tensile N_{Rd}: single anchor, no edge effects					
	Non-cracked concrete					
	HIT-Z / HIT-Z-R [kN]	15,6	15,6	15,6	31,7	33,7
	Cracked concrete					
	HIT-Z / HIT-Z-R [kN]	11,2	11,2	11,2	22,6	24,0
		Shear V_{Rd}: single anchor, no edge effects, without lever arm				
Non-cracked concrete						
HIT-Z [kN]		9,6	15,2	21,6	38,4	58,4
HIT-Z-R [kN]		11,2	18,4	26,4	45,6	67,3
Cracked concrete						
HIT-Z [kN]		9,6	15,2	21,6	38,4	48,0
HIT-Z-R [kN]	11,2	18,4	22,3	45,1	48,0	

Design resistance: concrete C 20/25 – $f_{ck,cube} = 25 \text{ N/mm}^2$

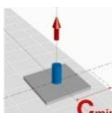
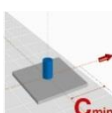
Anchor size	M8	M10	M12	M16	M20	
Embedment depth $h_{nom,min} =$ [mm]	60	60	60	96	100	
Base material thickness $h_{min} =$ [mm]	120	120	120	196	200	
	Tensile N_{Rd}: single anchor, min. edge distance ($c = c_{min}$)					
	Non-cracked concrete					
	c_{min} [mm]	40	80	115	110	165
	HIT-Z / HIT-Z-R [kN]	7,8	10,5	13,2	20,1	25,7
	Cracked concrete					
	c_{min} [mm]	40	80	115	110	165
HIT-Z / HIT-Z-R [kN]	6,7	10,2	11,2	18,5	24,0	
	Shear V_{Rd}: single anchor, min. edge distance ($c = c_{min}$), without lever arm					
	Non-cracked concrete					
	c_{min} [mm]	40	80	115	110	165
	HIT-Z [kN]	3,5	9,2	12,8	16,3	26,0
	HIT-Z-R [kN]	3,5	9,2	12,8	16,3	26,0
	Cracked concrete					
c_{min} [mm]	40	80	115	110	165	
HIT-Z [kN]	2,5	6,5	9,1	11,6	18,4	
HIT-Z-R [kN]	2,5	6,5	9,1	11,6	18,4	

Design resistance: concrete C 20/25 – $f_{ck,cube} = 25 \text{ N/mm}^2$
(load values are valid for single anchor)

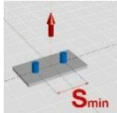
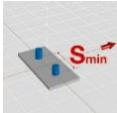
Anchor size	M8	M10	M12	M16	M20	
Embedment depth $h_{nom,min} =$ [mm]	60	60	60	96	100	
Base material thickness $h_{min} =$ [mm]	120	120	120	196	200	
	Tensile N_{Rd}: double anchor, no edge effects, min. spacing ($s = s_{min}$)					
	Non-cracked concrete					
	s_{min} [mm]	40	50	60	80	100
	HIT-Z / HIT-Z-R [kN]	8,9	9,2	9,5	18,7	20,3
	Cracked concrete					
	s_{min} [mm]	40	50	60	80	100
	Shear V_{Rd}: double anchor, no edge effects, min. spacing ($s = s_{min}$), without lever arm					
	Non-cracked concrete					
	s_{min} [mm]	40	50	60	80	100
	HIT-Z [kN]	9,6	15,2	20,9	38,4	44,9
	HIT-Z-R [kN]	11,2	18,4	20,9	40,5	44,9
	Cracked concrete					
s_{min} [mm]	40	50	60	80	100	
HIT-Z [kN]	9,6	14,3	14,9	28,8	32,0	
HIT-Z-R [kN]	11,2	14,3	14,9	28,8	32,0	

Design resistance: concrete C 20/25 – $f_{ck,cube} = 25 \text{ N/mm}^2$

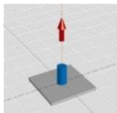
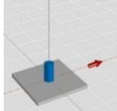
Anchor size	M8	M10	M12	M16	M20	
Embedment depth $h_{nom,typ} =$ [mm]	70	90	110	145	180	
Base material thickness $h_{min} =$ [mm]	130	150	170	245	280	
	Tensile N_{Rd}: single anchor, no edge effects					
	Non-cracked concrete					
	HIT-Z / HIT-Z-R [kN]	16,0	25,3	36,2	58,8	81,3
	Cracked concrete					
HIT-Z / HIT-Z-R [kN]	14,1	20,5	27,7	41,9	58,0	
	Shear V_{Rd}: single anchor, no edge effects, without lever arm					
	Non-cracked concrete					
	HIT-Z [kN]	9,6	15,2	21,6	38,4	58,4
	HIT-Z-R [kN]	11,2	18,4	26,4	45,6	70,4
	Cracked concrete					
	HIT-Z [kN]	9,6	15,2	21,6	38,4	58,4
HIT-Z-R [kN]	11,2	18,4	26,4	45,6	70,4	

Design resistance: concrete C 20/25 – $f_{ck,cube} = 25 \text{ N/mm}^2$

Anchor size	M8	M10	M12	M16	M20
Embedment depth $h_{nom,typ} =$ [mm]	70	90	110	145	180
Base material thickness $h_{min} =$ [mm]	130	150	170	245	280
Tensile N_{Rd}: single anchor, min. edge distance ($c = c_{min}$)					
Non-cracked concrete					
c_{min} [mm]	40	65	80	90	120
HIT-Z / HIT-Z-R [kN]	9,1	13,7	18,1	27,0	37,2
Cracked concrete					
c_{min} [mm]	40	65	80	90	120
HIT-Z / HIT-Z-R [kN]	7,9	12,8	17,4	24,4	34,9
Shear V_{Rd}: single anchor, min. edge distance ($c = c_{min}$), without lever arm					
Non-cracked concrete					
c_{min} [mm]	40	65	80	90	120
HIT-Z [kN]	3,6	7,5	10,6	13,8	21,8
HIT-Z-R [kN]	3,6	7,5	10,6	13,8	21,8
Cracked concrete					
c_{min} [mm]	40	65	80	90	120
HIT-Z [kN]	2,6	5,3	7,5	9,8	15,5
HIT-Z-R [kN]	2,6	5,3	7,5	9,8	15,5

Design resistance: concrete C 20/25 – $f_{ck,cube} = 25 \text{ N/mm}^2$
(load values are valid for single anchor)

Anchor size	M8	M10	M12	M16	M20
Embedment depth $h_{nom,typ} =$ [mm]	70	90	110	145	180
Base material thickness $h_{min} =$ [mm]	130	150	170	245	280
Tensile N_{Rd}: double anchor, no edge effects, min. spacing ($s = s_{min}$)					
Non-cracked concrete					
s_{min} [mm]	40	50	60	80	100
HIT-Z / HIT-Z-R [kN]	10,9	15,7	21,0	32,1	44,1
Cracked concrete					
s_{min} [mm]	40	50	60	80	100
HIT-Z / HIT-Z-R [kN]	8,4	12,1	16,4	24,8	34,3
Shear V_{Rd}: double anchor, no edge effects, min. spacing ($s = s_{min}$), without lever arm					
Non-cracked concrete					
s_{min} [mm]	40	50	60	80	100
HIT-Z [kN]	9,6	15,2	21,6	38,4	58,4
HIT-Z-R [kN]	11,2	18,4	26,4	45,6	70,4
Cracked concrete					
s_{min} [mm]	40	50	60	80	100
HIT-Z [kN]	9,6	15,2	21,6	38,4	58,4
HIT-Z-R [kN]	11,2	18,4	26,4	45,6	68,7

Design resistance: concrete C 20/25 – $f_{ck,cube} = 25 \text{ N/mm}^2$

Anchor size	M8	M10	M12	M16	M20	
Embedment depth $h_{nom,max} =$ [mm]	100	120	150	200	220	
Base material thickness $h_{min} =$ [mm]	160	180	210	300	320	
	Tensile N_{Rd}: single anchor, no edge effects					
	Non-cracked concrete					
	HIT-Z / HIT-Z-R [kN]	16,0	25,3	36,2	64,0	97,3
	Cracked concrete					
	HIT-Z / HIT-Z-R [kN]	16,0	25,3	33,2	64,0	78,3
		Shear V_{Rd}: single anchor, no edge effects, without lever arm				
Non-cracked concrete						
HIT-Z [kN]		9,6	15,2	21,6	38,4	58,4
HIT-Z-R [kN]		11,2	18,4	26,4	45,6	70,4
Cracked concrete						
HIT-Z [kN]		9,6	15,2	21,6	38,4	58,4
HIT-Z-R [kN]	11,2	18,4	26,4	45,6	70,4	

Design resistance: concrete C 20/25 – $f_{ck,cube} = 25 \text{ N/mm}^2$

Anchor size	M8	M10	M12	M16	M20	
Embedment depth $h_{nom,max} =$ [mm]	100	120	150	200	220	
Base material thickness $h_{min} =$ [mm]	160	180	210	300	320	
	Tensile N_{Rd}: single anchor, min. edge distance ($c = c_{min}$)					
	Non-cracked concrete					
	c_{min} [mm]	40	55	65	80	105
	HIT-Z / HIT-Z-R [kN]	10,1	15,6	18,6	38,7	46,3
	Cracked concrete					
	c_{min} [mm]	40	55	65	80	105
HIT-Z / HIT-Z-R [kN]	9,2	14,3	17,1	33,5	41,1	
	Shear V_{Rd}: single anchor, min. edge distance ($c = c_{min}$), without lever arm					
	Non-cracked concrete					
	c_{min} [mm]	40	55	65	80	105
	HIT-Z [kN]	3,9	6,4	8,7	13,0	19,6
	HIT-Z-R [kN]	3,9	6,4	8,7	13,0	19,6
	Cracked concrete					
c_{min} [mm]	40	55	65	80	105	
HIT-Z [kN]	2,8	4,6	6,2	9,2	13,9	
HIT-Z-R [kN]	2,8	4,6	6,2	9,2	13,9	

Design resistance: concrete C 20/25 – $f_{ck,cube} = 25 \text{ N/mm}^2$
(load values are valid for single anchor)

Anchor size	M8	M10	M12	M16	M20
Embedment depth $h_{nom,max} =$ [mm]	100	120	150	200	220
Base material thickness $h_{min} =$ [mm]	160	180	210	300	320
Tensile N_{Rd}: double anchor, no edge effects, min. spacing ($s = s_{min}$)					
Non-cracked concrete					
s_{min} [mm]	40	50	60	80	100
HIT-Z / HIT-Z-R [kN]	11,5	17,2	20,6	44,0	57,9
Cracked concrete					
s_{min} [mm]	40	50	60	80	100
HIT-Z / HIT-Z-R [kN]	10,5	15,8	18,9	38,5	45,1
Shear V_{Rd}: double anchor, no edge effects, min. spacing ($s = s_{min}$) , without lever arm					
Non-cracked concrete					
s_{min} [mm]	40	50	60	80	100
HIT-Z [kN]	9,6	15,2	21,6	38,4	58,4
HIT-Z-R [kN]	11,2	18,4	26,4	45,6	70,4
Cracked concrete					
s_{min} [mm]	40	50	60	80	100
HIT-Z [kN]	9,6	15,2	21,6	38,4	58,4
HIT-Z-R [kN]	11,2	18,4	26,4	45,6	70,4

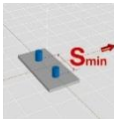
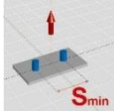

Seismic design C1 and C2

Basic loading data for concrete C20/25 – C50/60

All data in this section applies to:

- Seismic design according to TR045

The following technical data are based on: ETA-12/0006 and ETA-12/0028, issue 2013-03-15

Anchorage depth range

Anchor size		M8	M10	M12	M16	M20
Nominal anchorage depth range	$h_{nom,min}$ [mm]	60	60	60	96	100
	$h_{nom,max}$ [mm]	100	120	144	192	220

Tension resistance in case of seismic performance category C1

Anchor size		M8	M10	M12	M16	M20
Characteristic tension resistance to steel failure						
HIT-Z / HIT-Z-R	$N_{RK,s,seis}$ [kN]	24	38	55	96	146
Partial safety factor	$\gamma_{Ms,seis}$ [-]	1,5				
Characteristic bond resistance in cracked concrete C20/25 to C50/60						
Temperature range I: 24°C/40°C	$\tau_{RK,seis}$ [N/mm ²]	21				
Temperature range II: 50°C/80°C	$\tau_{RK,seis}$ [N/mm ²]	19				
Temperature range III: 72°C/120°C	$\tau_{RK,seis}$ [N/mm ²]	17				
Partial safety factor	$\gamma_{Mp,seis}$ [-]	1,5				
Concrete cone resistance and splitting resistance						
Partial safety factor	$\gamma_{Mc,seis} = \gamma_{Msp,seis}$ [-]	1,5				

Displacement under tension load in case of seismic performance category C1 ¹⁾

Anchor size		M8	M10	M12	M16	M20
Displacement (HIT-Z / HIT-Z-R)	$\delta_{N,seis}$ [mm]	1,2	1,9	1,7	1,3	1,8

1) Maximum displacement during cycling (seismic event).

Shear resistance in case of seismic performance category C1 ¹⁾

Anchor size		M8	M10	M12	M16	M20
Characteristic shear resistance to steel failure						
HIT-Z	$V_{RK,s,seis}$ [kN]	7	17	16	28	45
HIT-Z-R	$V_{RK,s,seis}$ [kN]	8	19	22	31	48
Partial safety factor	$\gamma_{Ms,seis}$ [-]	1,25				
Concrete pryout resistance and concrete edge resistance						
Partial safety factor	$\gamma_{Mcp,seis} = \gamma_{Mc,seis}$ [-]	1,5				

1) Reduction factor $\alpha_{gap} = 1,0$ when using the Hilti Dynamic Set

Displacement under shear load in case of seismic performance category C1 ¹⁾

Anchor size		M8	M10	M12	M16	M20
Displacement (HIT-Z)	$\delta_{V,seis}$ [mm]	4,0	5,0	4,9	4,3	5,5
Displacement (HIT-Z-R)	$\delta_{V,seis}$ [mm]	5,0	5,6	5,9	6,0	6,4

1) Maximum displacement during cycling (seismic event).

Tension resistance in case of seismic performance category C2

Anchor size		M12	M16
Characteristic tension resistance to steel failure			
HIT-Z / HIT-Z-R	$N_{Rk,s,seis}$ [kN]	55	96
Partial safety factor ¹⁾	$\gamma_{Ms,seis}$ [-]	1,5	
Characteristic bond resistance in cracked concrete C20/25 to C50/60			
Temperature range I: 24°C/40°C	$\tau_{Rk,seis}$ [N/mm ²]	13	19
Temperature range II: 50°C/80°C	$\tau_{Rk,seis}$ [N/mm ²]	12	17
Temperature range III: 72°C/120°C	$\tau_{Rk,seis}$ [N/mm ²]	10	16
Partial safety factor	$\gamma_{Mp,seis}$ [-]	1,5	
Concrete cone resistance and splitting resistance			
Partial safety factor	$\gamma_{Mc,seis} = \gamma_{Msp,seis}$ [-]	1,5	

Displacement under tension load in case of seismic performance category C2

Anchor size		M12	M16
Displacement DLS (HIT-Z / HIT-Z-R)	$\delta_{N,seis}$ [mm]	1,3	1,9
Displacement ULS (HIT-Z / HIT-Z-R)	$\delta_{N,seis}$ [mm]	3,2	3,6

Shear resistance in case of seismic performance category C2 ¹⁾

Anchor size		M12	M16
Characteristic shear resistance to steel failure			
HIT-Z	$V_{Rk,s,seis}$ [kN]	11	17
HIT-Z-R	$V_{Rk,s,seis}$ [kN]	16	21
Partial safety factor	$\gamma_{Ms,seis}$ [-]	1,25	
Concrete pryout resistance and concrete edge resistance			
Partial safety factor	$\gamma_{Mcp,seis} = \gamma_{Mc,seis}$ [-]	1,5	





1) Reduction factor $\alpha_{gap} = 1,0$ when using the Hilti Dynamic Set

Displacement under shear load in case of seismic performance category C2

Anchor size		M12	M16
Displacement DLS (HIT-Z)	$\delta_{V,seis}$ [mm]	2,8	3,1
Displacement ULS (HIT-Z)	$\delta_{V,seis}$ [mm]	4,6	6,2
Displacement DLS (HIT-Z-R)	$\delta_{V,seis}$ [mm]	3,0	3,1
Displacement ULS (HIT-Z-R)	$\delta_{V,seis}$ [mm]	6,2	6,2

For seismic resistant fastening applications please use the anchor design software PROFIS Anchor.

Hilti HIT-HY 200 mortar with HIT-V rod

Injection mortar system		Benefits
 <p>Hilti HIT-HY 200-A 500 ml foil pack (also available as 330 ml foil pack)</p>	<p>Hilti HIT-HY 200-R 500 ml foil pack (also available as 330 ml foil pack)</p> <p>Static mixer</p> <p>HIT-V rods HIT-V-R rods HIT-V-HCR rods</p>	<ul style="list-style-type: none"> - SAFEset technology: drilling and borehole cleaning in one step with Hilti hollow drill bit - Suitable for non-cracked and cracked concrete C 20/25 to C 50/60 - ETA seismic approval C1 - High loading capacity, excellent handling and fast curing - Small edge distance and anchor spacing possible - Large diameter applications - Max In service temperature range up to 120°C short term/ 72°C long term - Manual cleaning for borehole diameter up to 20mm and hef ≤ 10d for non-cracked concrete only - Embedment depth range: from 60 ... 160 mm for M8 to 120 ... 600 mm for M30 - Two mortar (A and R) versions available with different curing times and same performance
		
		
		



Concrete



Tensile zone



Seismic
ETA-C1



Small edge distance and spacing



Variable embedment depth



Fire resistance



Approved automatic cleaning while drilling

SAFEset

Hilti **SAFEset** technology

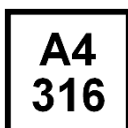

Corrosion resistance



High corrosion resistance



European Technical Approval



CE conformity



PROFIS Anchor design software

Approvals / certificates

Description	Authority / Laboratory	No. / date of issue
European technical approval ^{a)}	DIBt, Berlin	ETA-11/0493 / 2013-06-20 (Hilti HIT-HY 200-A) ETA-12/0084 / 2013-06-20 (Hilti HIT-HY 200-R)
Fire test report	IBMB, Brunswick	3501/676/13 / 2012-08-03

a) All data given in this section according ETA-11/0493 and ETA-12/0084, issue 2013-06-20.

Basic loading data (for a single anchor)

All data in this section applies to

For details see Simplified design method

- Correct setting (See setting instruction)
- No edge distance and spacing influence
- Steel failure
- Base material thickness, as specified in the table
- One typical embedment depth, as specified in the table
- One anchor material, as specified in the tables
- Concrete C 20/25, $f_{ck,cube} = 25 \text{ N/mm}^2$
- Temperate range I
(min. base material temperature -40°C , max. long term/short term base material temperature: $+24^\circ\text{C}/40^\circ\text{C}$)
- Installation temperature range -10°C to $+40^\circ\text{C}$

Embedment depth ^{a)} and base material thickness for the basic loading data. Mean ultimate resistance, characteristic resistance, design resistance, recommended loads.

Anchor size	M8	M10	M12	M16	M20	M24	M27	M30
Typical embedment depth h_{ef} [mm]	80	90	110	125	170	210	240	270
Base material thickness h [mm]	110	120	140	165	220	270	300	340

a) The allowed range of embedment depth is shown in the setting details. The corresponding load values can be calculated according to the simplified design method.

Mean ultimate resistance: concrete C 20/25 , anchor HIT-V 5.8

Anchor size	M8	M10	M12	M16	M20	M24	M27	M30
Non-cracked concrete								
Tensile $N_{Ru,m}$ HIT-V 5.8 [kN]	18,9	30,5	44,1	83,0	129,2	185,9	241,5	295,1
Shear $V_{Ru,m}$ HIT-V 5.8 [kN]	9,5	15,8	22,1	41,0	64,1	92,4	120,8	147,0
Cracked concrete								
Tensile $N_{Ru,m}$ HIT-V 5.8 [kN]	16,0	22,5	44,0	66,7	105,9	145,4	177,7	212,0
Shear $V_{Ru,m}$ HIT-V 5.8 [kN]	9,5	15,8	22,1	41,0	64,1	92,4	120,8	147,0

Characteristic resistance: concrete C 20/25 , anchor HIT-V 5.8

Anchor size	M8	M10	M12	M16	M20	M24	M27	M30
Non-cracked concrete								
Tensile N_{Rk} HIT-V 5.8 [kN]	18,0	29,0	42,0	70,6	111,9	153,7	187,8	224,0
Shear V_{Rk} HIT-V 5.8 [kN]	9,0	15,0	21,0	39,0	61,0	88,0	115,0	140,0
Cracked concrete								
Tensile N_{Rk} HIT-V 5.8 [kN]	12,1	17,0	33,2	50,3	79,8	109,6	133,9	159,7
Shear V_{Rk} HIT-V 5.8 [kN]	9,0	15,0	21,0	39,0	61,0	88,0	115,0	140,0

Design resistance: concrete C 20/25 , anchor HIT-V 5.8

Anchor size	M8	M10	M12	M16	M20	M24	M27	M30
Non-cracked concrete								
Tensile N_{Rd} HIT-V 5.8 [kN]	12,0	19,3	28,0	39,2	62,2	85,4	104,3	124,5
Shear V_{Rd} HIT-V 5.8 [kN]	7,2	12,0	16,8	31,2	48,8	70,4	92,0	112,0
Cracked concrete								
Tensile N_{Rd} HIT-V 5.8 [kN]	6,7	9,4	18,4	27,9	44,3	60,9	74,4	88,7
Shear V_{Rd} HIT-V 5.8 [kN]	7,2	12,0	16,8	31,2	48,8	70,4	92,0	112,0

Recommended loads ^{a)}: concrete C 20/25 , anchor HIT-V 5.8

Anchor size			M8	M10	M12	M16	M20	M24	M27	M30
Non-cracked concrete										
Tensile N _{rec}	HIT-V 5.8	[kN]	8,6	13,8	20,0	28,0	44,4	61,0	74,5	88,9
Shear V _{rec}	HIT-V 5.8	[kN]	5,1	8,6	12,0	22,3	34,9	50,3	65,7	80,0
Cracked concrete										
Tensile N _{rec}	HIT-V 5.8	[kN]	4,8	6,7	13,2	19,9	31,7	43,5	53,1	63,4
Shear V _{rec}	HIT-V 5.8	[kN]	5,1	8,6	12,0	22,3	34,9	50,3	65,7	80,0

a) With overall partial safety factor for action $\gamma = 1,4$. The partial safety factors for action depend on the type of loading and shall be taken from national regulations.

Service temperature range

Hilti HIT-HY 200 injection mortar may be applied in the temperature ranges given below. An elevated base material temperature may lead to a reduction of the design bond resistance.

Temperature range	Base material temperature	Maximum long term base material temperature	Maximum short term base material temperature
Temperature range I	-40 °C to +40 °C	+24 °C	+40 °C
Temperature range II	-40 °C to +80 °C	+50 °C	+80 °C
Temperature range III	-40 °C to +120 °C	+72 °C	+120 °C

Max short term base material temperature

Short-term elevated base material temperatures are those that occur over brief intervals, e.g. as a result of diurnal cycling.

Max long term base material temperature

Long-term elevated base material temperatures are roughly constant over significant periods of time.

Materials

Mechanical properties of HIT-V

Anchor size			M8	M10	M12	M16	M20	M24	M27	M30
Nominal tensile strength f _{uk}	HIT-V 5.8	[N/mm ²]	500	500	500	500	500	500	500	500
	HIT-V 8.8	[N/mm ²]	800	800	800	800	800	800	800	800
	HIT-V-R	[N/mm ²]	700	700	700	700	700	700	500	500
	HIT-V-HCR	[N/mm ²]	800	800	800	800	800	700	700	700
Yield strength f _{yk}	HIT-V 5.8	[N/mm ²]	400	400	400	400	400	400	400	400
	HIT-V 8.8	[N/mm ²]	640	640	640	640	640	640	640	640
	HIT-V-R	[N/mm ²]	450	450	450	450	450	450	210	210
	HIT-V-HCR	[N/mm ²]	640	640	640	640	640	400	400	400
Stressed cross-section A _s	HIT-V	[mm ²]	36,6	58,0	84,3	157	245	353	459	561
Moment of resistance W	HIT-V	[mm ³]	31,2	62,3	109	277	541	935	1387	1874

Material quality

Part	Material
Threaded rod HIT-V(F)	Strength class 5.8, $A_5 > 8\%$ ductile steel galvanized $\geq 5 \mu\text{m}$, (F) hot dipped galvanized $\geq 45 \mu\text{m}$,
Threaded rod HIT-V(F)	Strength class 8.8, $A_5 > 8\%$ ductile steel galvanized $\geq 5 \mu\text{m}$, (F) hot dipped galvanized $\geq 45 \mu\text{m}$,
Threaded rod HIT-V-R	Stainless steel grade A4, $A_5 > 8\%$ ductile strength class 70 for $\leq \text{M24}$ and class 50 for M27 to M30, 1.4401; 1.4404; 1.4578; 1.4571; 1.4439; 1.4362
Threaded rod HIT-V-HCR	High corrosion resistant steel, 1.4529; 1.4565 strength $\leq \text{M20}$: $R_m = 800 \text{ N/mm}^2$, $R_{p0.2} = 640 \text{ N/mm}^2$, $A_5 > 8\%$ ductile M24 to M30: $R_m = 700 \text{ N/mm}^2$, $R_{p0.2} = 400 \text{ N/mm}^2$, $A_5 > 8\%$ ductile
Washer ISO 7089	Steel galvanized, hot dipped galvanized,
	Stainless steel, 1.4401; 1.4404; 1.4578; 1.4571; 1.4439; 1.4362
	High corrosion resistant steel, 1.4529; 1.4565
Nut EN ISO 4032	Strength class 8, steel galvanized $\geq 5 \mu\text{m}$, hot dipped galvanized $\geq 45 \mu\text{m}$,
	Strength class 70, stainless steel grade A4, 1.4401; 1.4404; 1.4578; 1.4571; 1.4439; 1.4362
	Strength class 70, high corrosion resistant steel, 1.4529; 1.4565

Anchor dimensions

Anchor size	M8	M10	M12	M16	M20	M24	M27	M30
Anchor rod HIT-V, HIT-V-R, HIT-V-HCR	Anchor rods HIT-V (-R / -HCR) are available in variable length							

Setting

installation equipment

Anchor size	M8	M10	M12	M16	M20	M24	M27	M30
Rotary hammer	TE 2 – TE 16				TE 40 – TE 70			
Other tools, hammer drilling	compressed air gun or blow out pump, set of cleaning brushes, dispenser							

Setting instruction

Bore hole drilling

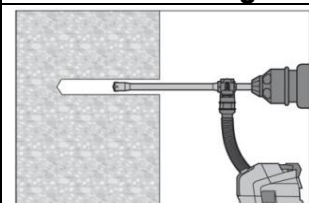

Drill hole to the required embedment depth with an appropriately sized Hilti TE-CD or TE-YD hollow drill bit with Hilti vacuum attachment. This drilling method properly cleans the borehole and removes dust while drilling. After drilling is complete, proceed to the "injection preparation" step in the instructions for use.

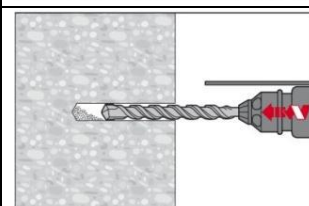

Drill Hole to the required embedment depth with a hammer drill set in rotation-hammer mode using an appropriately sized carbide drill bit.

Bore hole cleaning Just before setting an anchor, the bore hole must be free of dust and debris.

a) Manual Cleaning (MC) non-cracked concrete only

for bore hole diameters $d_0 \leq 20\text{mm}$ and bore hole depth $h_0 \leq 10d$

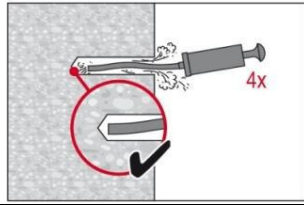

The Hilti manual pump may be used for blowing out bore holes up to diameters $d_0 \leq 20\text{ mm}$ and embedment depths up to $h_{ef} \leq 10d$. Blow out at least 4 times from the back of the bore hole until return air stream is free of noticeable dust

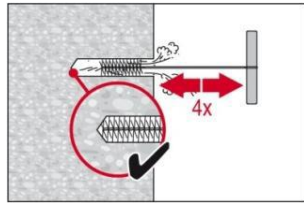

Brush 4 times with the specified brush size by inserting the steel brush Hilti HIT-RB to the back of the hole (if needed with extension) in a twisting motion and removing it. The brush must produce natural resistance as it enters the bore hole -- if not the brush is too small and must be replaced with the proper brush diameter.

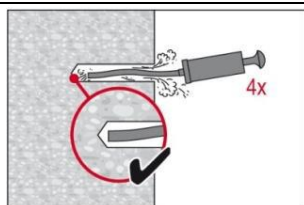

Blow out again with manual pump at least 4 times until return air stream is free of noticeable dust.

b) Compressed air cleaning (CAC)

for all bore hole diameters d_0 and all bore hole depth h_0

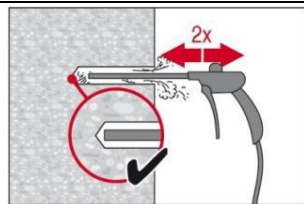

Blow 2 times from the back of the hole (if needed with nozzle extension) over the hole length with oil-free compressed air (min. 6 bar at 6 m³/h) until return air stream is free of noticeable dust. Bore hole diameter $\geq 32\text{ mm}$ the compressor must supply a minimum air flow of 140 m³/hour.

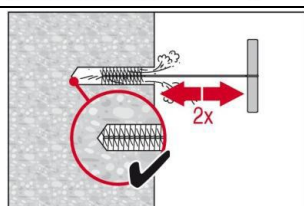

Brush 2 times with the specified brush size by inserting the steel brush Hilti HIT-RB to the back of the hole (if needed with extension) in a twisting motion and removing it. The brush must produce natural resistance as it enters the bore hole -- if not the brush is too small and must be replaced with the proper brush diameter.

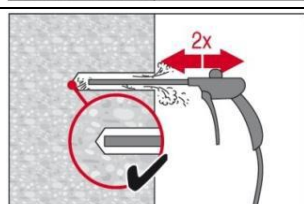

Blow again with compressed air 2 times until return air stream is free of noticeable dust.

Injection preparation

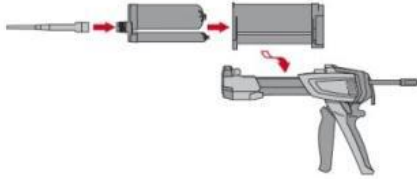

Tightly attach new Hilti mixing nozzle HIT-RE-M to foil pack manifold (snug fit). Do not modify the mixing nozzle. Observe the instruction for use of the dispenser. Check foil pack holder for proper function. Do not use damaged foil packs / holders. Swing foil pack holder with foil pack into HIT-dispenser.

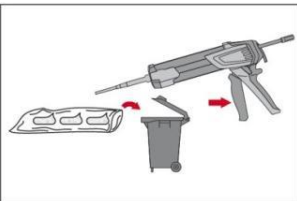

Discard initial adhesive. The foil pack opens automatically as dispensing is initiated. Depending on the size of the foil pack an initial amount of adhesive has to be discarded.

Discard quantities are:

- 2 strokes for 330 ml foil pack,
- 3 strokes for 500 ml foil pack,
- 4 strokes for 500 ml foil pack $\leq 5^{\circ}\text{C}$.

Inject adhesive from the back of the borehole without forming air voids

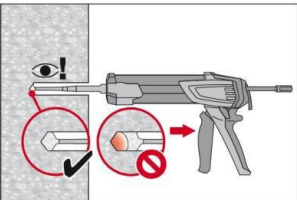

Inject the adhesive starting at the back of the hole, slowly withdrawing the mixer with each trigger pull. Fill holes approximately 2/3 full, or as required to ensure that the annular gap between the anchor and the concrete is completely filled with adhesive along the embedment length.

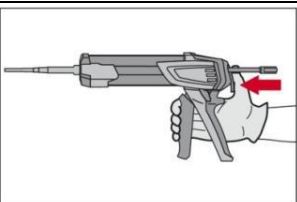

After injection is completed, depressurize the dispenser by pressing the release trigger. This will prevent further adhesive discharge from the mixer.

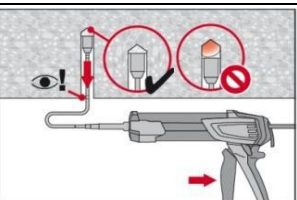

Overhead installation and/or installation with embedment depth $h_{ef} > 250\text{mm}$. For overhead installation the injection is only possible with the aid of extensions and piston plugs. Assemble HIT-RE-M mixer, extension(s) and appropriately sized piston plug. Insert piston plug to back of the hole and inject adhesive. During injection the piston plug will be naturally extruded out of the bore hole by the adhesive pressure.

Setting the element

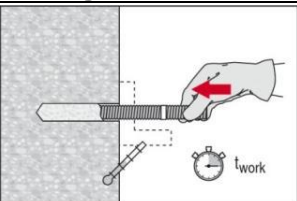

Before use, verify that the element is dry and free of oil and other contaminants. Mark and set element to the required embedment depth until working time t_{work} has elapsed.

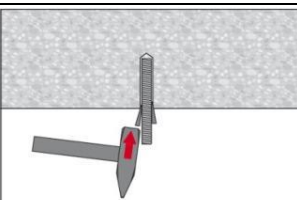

For overhead installation use piston plugs and fix embedded parts with e.g. wedges

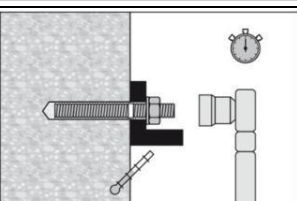

Loading the anchor:
After required curing time t_{cure} the anchor can be loaded.
The applied installation torque shall not exceed T_{max} .

For detailed information on installation see instruction for use given with the package of the product.

Working time, curing time

Temperature of the base material	Hilti HIT-HY 200-R	
	Working time in which anchor can be inserted and adjusted t_{work}	Curing time before anchor can be loaded t_{cure}
-10 °C to -5 °C	3 hour	20 hour
-4 °C to 0 °C	2 hour	8 hour
1 °C to 5 °C	1 hour	4 hour
6 °C to 10 °C	40 min	2,5 hour
11 °C to 20 °C	15 min	1,5 hour
21 °C to 30 °C	9 min	1 hour
31 °C to 40 °C	6 min	1 hour

Temperature of the base material	Hilti HIT-HY 200-A	
	Working time in which anchor can be inserted and adjusted t_{work}	Curing time before anchor can be loaded t_{cure}
-10 °C to -5 °C	1,5 hour	7 hour
-4 °C to 0 °C	50 min	4 hour
1 °C to 5 °C	25 min	2 hour
6 °C to 10 °C	15 min	75 min
11 °C to 20 °C	7 min	45 min
21 °C to 30 °C	4 min	30 min
31 °C to 40 °C	3 min	30 min

Setting details

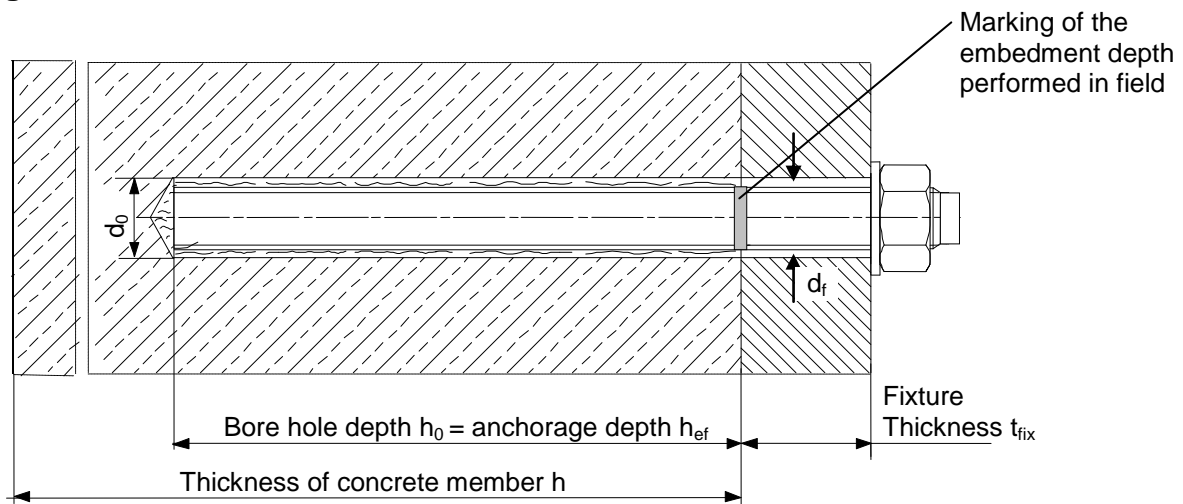

Setting details

Anchor size			M8	M10	M12	M16	M20	M24	M27	M30
Nominal diameter of drill bit	d_0	[mm]	10	12	14	18	22	28	30	35
Effective embedment and drill hole depth range ^{a)} for HIT-V	$h_{ef,min}$	[mm]	60	60	70	80	90	96	108	120
	$h_{ef,max}$	[mm]	160	200	240	320	400	480	540	600
Minimum base material thickness	h_{min}	[mm]	$h_{ef} + 30 \text{ mm}$			$h_{ef} + 2 d_0$				
Diameter of clearance hole in the fixture	d_f	[mm]	9	12	14	18	22	26	30	33
Torque moment	T_{max} ^{b)}	[Nm]	10	20	40	80	150	200	270	300
Minimum spacing	s_{min}	[mm]	40	50	60	80	100	120	135	150
Minimum edge distance	c_{min}	[mm]	40	50	60	80	100	120	135	150
Critical spacing for splitting failure	$s_{cr,sp}$	[mm]	$2 c_{cr,sp}$							
Critical edge distance for splitting failure ^{c)}	$c_{cr,sp}$	[mm]	$1,0 \cdot h_{ef}$ for $h / h_{ef} \geq 2,0$							
			$4,6 h_{ef} - 1,8 h$ for $2,0 > h / h_{ef} > 1,3$							
			$2,26 h_{ef}$ for $h / h_{ef} \leq 1,3$							
Critical spacing for concrete cone failure	$s_{cr,N}$	[mm]	$2 c_{cr,N}$							
Critical edge distance for concrete cone failure ^{d)}	$c_{cr,N}$	[mm]	$1,5 h_{ef}$							

For spacing (or edge distance) smaller than critical spacing (or critical edge distance) the design loads have to be reduced.

- a) Embedment depth range: $h_{ef,min} \leq h_{ef} \leq h_{ef,max}$
- b) Maximum recommended torque moment to avoid splitting failure during installation with minimum spacing and/or edge distance.
- c) h : base material thickness ($h \geq h_{min}$), h_{ef} : embedment depth
- d) The critical edge distance for concrete cone failure depends on the embedment depth h_{ef} and the design bond resistance. The simplified formula given in this table is on the safe side.

Simplified design method

Simplified version of the design method according ETAG 001, TR 029. Design resistance according data given in ETA-11/0493 issued 2013-06-20 for HIT-HY 200-A and ETA-12/0084 issued 2013-06-20 for HIT-HY 200-R. Both mortars possess identical technical load performance.

- Influence of concrete strength
- Influence of edge distance
- Influence of spacing
- Valid for a group of two anchors. (The method may also be applied for anchor groups with more than two anchors or more than one edge distance. The influencing factors must then be considered for each edge distance and spacing. The simplified calculated design loads take a conservative approach: They will be lower than the exact values according to ETAG 001, TR 029. For an optimized design, anchor calculation can be performed using PROFIS anchor design software.

The design method is based on the following simplification:

- No different loads are acting on individual anchors (no eccentricity)

The values are valid for one anchor.

For more complex fastening applications please use the anchor design software PROFIS Anchor.

Tension loading

The design tensile resistance is the lower value of

- Steel resistance: $N_{Rd,s}$
- Combined pull-out and concrete cone resistance: $N_{Rd,p} = N_{Rd,p}^0 \cdot f_{B,p} \cdot f_{1,N} \cdot f_{2,N} \cdot f_{3,N} \cdot f_{h,p} \cdot f_{re,N}$
- Concrete cone resistance: $N_{Rd,c} = N_{Rd,c}^0 \cdot f_B \cdot f_{1,N} \cdot f_{2,N} \cdot f_{3,N} \cdot f_{h,N} \cdot f_{re,N}$
- Concrete splitting resistance (only non-cracked concrete): $N_{Rd,sp} = N_{Rd,c}^0 \cdot f_B \cdot f_{1,sp} \cdot f_{2,sp} \cdot f_{3,sp} \cdot f_{h,N} \cdot f_{re,N}$

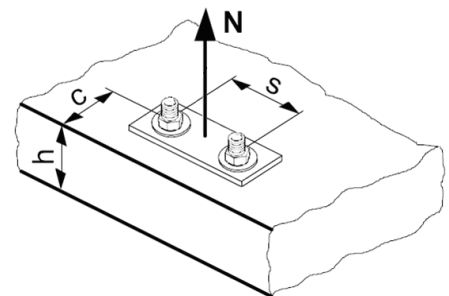

Basic design tensile resistance

Design steel resistance $N_{Rd,s}$

Anchor size		M8	M10	M12	M16	M20	M24	M27	M30
$N_{Rd,s}$	HIT-V 5.8 [kN]	12,0	19,3	28,0	52,7	82,0	118,0	153,3	187,3
	HIT-V 8.8 [kN]	19,3	30,7	44,7	84,0	130,7	188,0	244,7	299,3
	HIT-V-R [kN]	13,9	21,9	31,6	58,8	92,0	132,1	80,4	98,3
	HIT-V-HCR [kN]	19,3	30,7	44,7	84,0	130,7	117,6	152,9	187,1

Design combined pull-out and concrete cone resistance

$$N_{Rd,p} = N_{Rd,p}^0 \cdot f_{B,p} \cdot f_{1,N} \cdot f_{2,N} \cdot f_{3,N} \cdot f_{h,p} \cdot f_{re,N}$$

Anchor size	M8	M10	M12	M16	M20	M24	M27	M30
Typical embedment depth $h_{ef} = h_{ef,typ}$ [mm]	80	90	110	125	170	210	240	270
Non-cracked concrete								
$N_{Rd,p}^0$ Temperature range I [kN]	22,3	31,4	46,1	69,8	118,7	175,9	169,6	212,1
$N_{Rd,p}^0$ Temperature range II [kN]	19,0	26,7	39,2	59,3	100,9	149,5	135,7	169,6
$N_{Rd,p}^0$ Temperature range III [kN]	15,6	22,0	32,3	48,9	83,1	123,2	124,4	155,5
Cracked concrete								
$N_{Rd,p}^0$ Temperature range I [kN]	6,7	9,4	18,4	27,9	47,5	70,4	90,5	113,1
$N_{Rd,p}^0$ Temperature range II [kN]	5,0	7,1	15,0	22,7	38,6	57,2	73,5	91,9
$N_{Rd,p}^0$ Temperature range III [kN]	4,5	6,3	12,7	19,2	32,6	48,4	62,2	77,8

$$\text{Design concrete cone resistance } N_{Rd,c} = N_{Rd,c}^0 \cdot f_B \cdot f_{1,N} \cdot f_{2,N} \cdot f_{3,N} \cdot f_{h,N} \cdot f_{re,N}$$

$$\text{Design splitting resistance } N_{Rd,sp} = N_{Rd,c}^0 \cdot f_B \cdot f_{1,sp} \cdot f_{2,sp} \cdot f_{3,sp} \cdot f_{h,N} \cdot f_{re,N}$$

Anchor size	M8	M10	M12	M16	M20	M24	M27	M30
$N_{Rd,c}^0$ Non-cracked concrete [kN]	20,1	24,0	32,4	39,2	62,2	85,4	104,3	124,5
$N_{Rd,c}^0$ Cracked concrete [kN]	14,3	17,1	23,1	28,0	44,3	60,9	74,4	88,7

a) Splitting resistance must only be considered for non-cracked concrete.

Influencing factors

Influence of concrete strength on combined pull-out and concrete cone resistance

Concrete strength designation (ENV 206)	C 20/25	C 25/30	C 30/37	C 35/45	C 40/50	C 45/55	C 50/60
$f_{B,p} =$	1,00	1,00	1,00	1,00	1,00	1,00	1,00

Influence of embedment depth on combined pull-out and concrete cone resistance

$f_{h,p} = h_{ef}/h_{ef,typ}$

Influence of concrete strength on concrete cone resistance

Concrete strength designation (ENV 206)	C 20/25	C 25/30	C 30/37	C 35/45	C 40/50	C 45/55	C 50/60
$f_B = (f_{ck,cube}/25N/mm^2)^{0,5 a)}$	1	1,1	1,22	1,34	1,41	1,48	1,55

a) $f_{ck,cube}$ = concrete compressive strength, measured on cubes with 150 mm side length

Influence of edge distance ^{a)}

$c/c_{cr,N}$	0,1	0,2	0,3	0,4	0,5	0,6	0,7	0,8	0,9	1
$c/c_{cr,sp}$										
$f_{1,N} = 0,7 + 0,3 \cdot c/c_{cr,N} \leq 1$	0,73	0,76	0,79	0,82	0,85	0,88	0,91	0,94	0,97	1
$f_{1,sp} = 0,7 + 0,3 \cdot c/c_{cr,sp} \leq 1$										
$f_{2,N} = 0,5 \cdot (1 + c/c_{cr,N}) \leq 1$	0,55	0,60	0,65	0,70	0,75	0,80	0,85	0,90	0,95	1
$f_{2,sp} = 0,5 \cdot (1 + c/c_{cr,sp}) \leq 1$										

a) The edge distance shall not be smaller than the minimum edge distance c_{min} . These influencing factors must be considered for every edge distance smaller than the critical edge distance.

Influence of anchor spacing ^{a)}

$s/s_{cr,N}$	0,1	0,2	0,3	0,4	0,5	0,6	0,7	0,8	0,9	1
$s/s_{cr,sp}$										
$f_{3,N} = 0,5 \cdot (1 + s/s_{cr,N}) \leq 1$										
$f_{3,sp} = 0,5 \cdot (1 + s/s_{cr,sp}) \leq 1$	0,55	0,60	0,65	0,70	0,75	0,80	0,85	0,90	0,95	1

a) The anchor spacing shall not be smaller than the minimum anchor spacing s_{min} . This influencing factor must be considered for every anchor spacing.

Influence of embedment depth on concrete cone resistance

$$f_{h,N} = (h_{ef}/h_{ef,typ})^{1,5}$$

Influence of reinforcement

h_{ef} [mm]	60	70	80	90	≥ 100
$f_{re,N} = 0,5 + h_{ef}/200mm \leq 1$	0,8 ^{a)}	0,85 ^{a)}	0,9 ^{a)}	0,95 ^{a)}	1

a) This factor applies only for dense reinforcement. If in the area of anchorage there is reinforcement with a spacing ≥ 150 mm (any diameter) or with a diameter ≤ 10 mm and a spacing ≥ 100 mm, then a factor $f_{re,N} = 1$ may be applied.

Shear loading

The design shear resistance is the lower value of

- Steel resistance: $V_{Rd,s}$
- Concrete pryout resistance: $V_{Rd,cp} = k \cdot \text{lower value of } N_{Rd,p} \text{ and } N_{Rd,c}$
- Concrete edge resistance: $V_{Rd,c} = V^0_{Rd,c} \cdot f_B \cdot f_{h'} \cdot f_4 \cdot f_{hef} \cdot f_c$

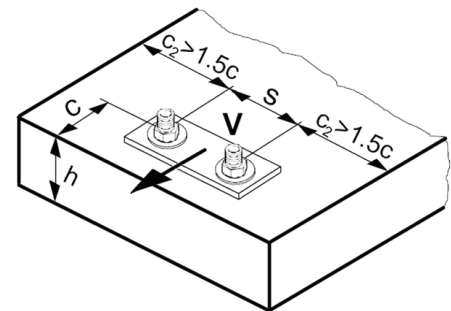

Basic design shear resistance

Design steel resistance $V_{Rd,s}$

Anchor size		M8	M10	M12	M16	M20	M24	M27	M30
$V_{Rd,s}$	HIT-V 5.8 [kN]	7,2	12,0	16,8	31,2	48,8	70,4	92,0	112,0
	HIT-V 8.8 [kN]	12,0	18,4	27,2	50,4	78,4	112,8	147,2	179,2
	HIT-V-R [kN]	8,3	12,8	19,2	35,3	55,1	79,5	48,3	58,8
	HIT-V-HCR [kN]	12,0	18,4	27,2	50,4	78,4	70,9	92,0	110,3

Design concrete pryout resistance $V_{Rd,cp} = \text{lower value}^a)$ of $k \cdot N_{Rd,p}$ and $k \cdot N_{Rd,c}$

$$k = 2$$

a) $N_{Rd,p}$: Design combined pull-out and concrete cone resistance, $N_{Rd,c}$: Design concrete cone resistance

Design concrete edge resistance $V_{Rd,c} = V^0_{Rd,c} \cdot f_B \cdot f_{h'} \cdot f_4 \cdot f_{hef} \cdot f_c$

Anchor size		M8	M10	M12	M16	M20	M24	M27	M30
Non-cracked concrete									
$V^0_{Rd,c}$ [kN]		5,9	8,6	11,6	18,7	27,0	36,6	44,5	53,0
Cracked concrete									
$V^0_{Rd,c}$ [kN]		4,2	6,1	8,2	13,2	19,2	25,9	31,5	37,5

Influencing factors

Influence of concrete strength

Concrete strength designation (ENV 206)	C 20/25	C 25/30	C 30/37	C 35/45	C 40/50	C 45/55	C 50/60
$f_B = (f_{ck,cube}/25N/mm^2)^{1/2}$ a)	1	1,1	1,22	1,34	1,41	1,48	1,55

a) $f_{ck,cube}$ = concrete compressive strength, measured on cubes with 150 mm side length

Influence of angle between load applied and the direction perpendicular to the free edge

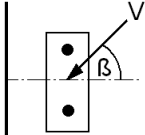
Angle β	0°	10°	20°	30°	40°	50°	60°	70°	80°	≥ 90°
$f_\beta = \sqrt{\frac{1}{(\cos \alpha_V)^2 + \left(\frac{\sin \alpha_V}{2,5}\right)^2}}$ 	1	1,01	1,05	1,13	1,24	1,40	1,64	1,97	2,32	2,50

Influence of base material thickness

h/c	0,15	0,3	0,45	0,6	0,75	0,9	1,05	1,2	1,35	≥ 1,5
$f_h = \{h/(1,5 \cdot c)\}^{1/2} \leq 1$	0,32	0,45	0,55	0,63	0,71	0,77	0,84	0,89	0,95	1,00

Influence of anchor spacing and edge distance ^{a)} for concrete edge resistance: f_4

$$f_4 = (c/h_{ef})^{1,5} \cdot (1 + s / [3 \cdot c]) \cdot 0,5$$

c/h _{ef}	Single anchor	Group of two anchors s/h _{ef}														
		0,75	1,50	2,25	3,00	3,75	4,50	5,25	6,00	6,75	7,50	8,25	9,00	9,75	10,50	11,25
0,50	0,35	0,27	0,35	0,35	0,35	0,35	0,35	0,35	0,35	0,35	0,35	0,35	0,35	0,35	0,35	0,35
0,75	0,65	0,43	0,54	0,65	0,65	0,65	0,65	0,65	0,65	0,65	0,65	0,65	0,65	0,65	0,65	0,65
1,00	1,00	0,63	0,75	0,88	1,00	1,00	1,00	1,00	1,00	1,00	1,00	1,00	1,00	1,00	1,00	1,00
1,25	1,40	0,84	0,98	1,12	1,26	1,40	1,40	1,40	1,40	1,40	1,40	1,40	1,40	1,40	1,40	1,40
1,50	1,84	1,07	1,22	1,38	1,53	1,68	1,84	1,84	1,84	1,84	1,84	1,84	1,84	1,84	1,84	1,84
1,75	2,32	1,32	1,49	1,65	1,82	1,98	2,15	2,32	2,32	2,32	2,32	2,32	2,32	2,32	2,32	2,32
2,00	2,83	1,59	1,77	1,94	2,12	2,30	2,47	2,65	2,83	2,83	2,83	2,83	2,83	2,83	2,83	2,83
2,25	3,38	1,88	2,06	2,25	2,44	2,63	2,81	3,00	3,19	3,38	3,38	3,38	3,38	3,38	3,38	3,38
2,50	3,95	2,17	2,37	2,57	2,77	2,96	3,16	3,36	3,56	3,76	3,95	3,95	3,95	3,95	3,95	3,95
2,75	4,56	2,49	2,69	2,90	3,11	3,32	3,52	3,73	3,94	4,15	4,35	4,56	4,56	4,56	4,56	4,56
3,00	5,20	2,81	3,03	3,25	3,46	3,68	3,90	4,11	4,33	4,55	4,76	4,98	5,20	5,20	5,20	5,20
3,25	5,86	3,15	3,38	3,61	3,83	4,06	4,28	4,51	4,73	4,96	5,18	5,41	5,63	5,86	5,86	5,86
3,50	6,55	3,51	3,74	3,98	4,21	4,44	4,68	4,91	5,14	5,38	5,61	5,85	6,08	6,31	6,55	6,55
3,75	7,26	3,87	4,12	4,36	4,60	4,84	5,08	5,33	5,57	5,81	6,05	6,29	6,54	6,78	7,02	7,26
4,00	8,00	4,25	4,50	4,75	5,00	5,25	5,50	5,75	6,00	6,25	6,50	6,75	7,00	7,25	7,50	7,75
4,25	8,76	4,64	4,90	5,15	5,41	5,67	5,93	6,18	6,44	6,70	6,96	7,22	7,47	7,73	7,99	8,25
4,50	9,55	5,04	5,30	5,57	5,83	6,10	6,36	6,63	6,89	7,16	7,42	7,69	7,95	8,22	8,49	8,75
4,75	10,35	5,45	5,72	5,99	6,27	6,54	6,81	7,08	7,36	7,63	7,90	8,17	8,45	8,72	8,99	9,26
5,00	11,18	5,87	6,15	6,43	6,71	6,99	7,27	7,55	7,83	8,11	8,39	8,66	8,94	9,22	9,50	9,78
5,25	12,03	6,30	6,59	6,87	7,16	7,45	7,73	8,02	8,31	8,59	8,88	9,17	9,45	9,74	10,02	10,31
5,50	12,90	6,74	7,04	7,33	7,62	7,92	8,21	8,50	8,79	9,09	9,38	9,67	9,97	10,26	10,55	10,85

a) The anchor spacing and the edge distance shall not be smaller than the minimum anchor spacing s_{min} and the minimum edge distance c_{min} .

Influence of embedment depth

h_{ef}/d	4	4,5	5	6	7	8	9	10	11
$f_{hef} = 0,05 \cdot (h_{ef} / d)^{1,68}$	0,51	0,63	0,75	1,01	1,31	1,64	2,00	2,39	2,81

h_{ef}/d	12	13	14	15	16	17	18	19	20
$f_{hef} = 0,05 \cdot (h_{ef} / d)^{1,68}$	3,25	3,72	4,21	4,73	5,27	5,84	6,42	7,04	7,67

Influence of edge distance ^{a)}

c/d	4	6	8	10	15	20	30	40
$f_c = (d / c)^{0,19}$	0,77	0,71	0,67	0,65	0,60	0,57	0,52	0,50

a) The edge distance shall not be smaller than the minimum edge distance c_{min} .

Combined tension and shear loading

For combined tension and shear loading see section "Anchor Design".

Precalculated values – design resistance values

All data applies to:

- non-cracked concrete C 20/25 – $f_{ck,cube} = 25 \text{ N/mm}^2$
- temperature range I (see service temperature range)
- minimum thickness of base material
- no effects of dense reinforcement

Recommended loads can be calculated by dividing the design resistance by an overall partial safety factor for action $\gamma = 1,4$. The partial safety factors for action depend on the type of loading and shall be taken from national regulations.

Design resistance: concrete C 20/25 – $f_{ck,cube} = 25 \text{ N/mm}^2$ - minimum embedment depth

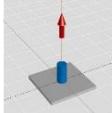
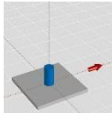
Anchor size		M8	M10	M12	M16	M20	M24	M27	M30	
Embedment depth $h_{ef} = h_{ef,min}$ [mm]		60	60	70	80	90	96	108	120	
Base material thickness $h = h_{min}$ [mm]		90	90	100	116	138	152	168	190	
	Tensile N_{Rd}: single anchor, no edge effects									
	Non-cracked concrete									
	HIT-V 5.8 [kN]	12,0	13,0	16,4	20,1	24,0	26,4	31,5	36,9	
	HIT-V 8.8 [kN]	13,0	13,0	16,4	20,1	24,0	26,4	31,5	36,9	
	HIT-V-R [kN]	13,0	13,0	16,4	20,1	24,0	26,4	31,5	36,9	
	HIT-V-HCR [kN]	13,0	13,0	16,4	20,1	24,0	26,4	31,5	36,9	
	Cracked concrete									
	HIT-V 5.8 / 8.8 [kN]	5,0	6,3	11,7	14,3	17,1	18,8	22,4	26,3	
	HIT-V-R / -HCR [kN]									
		Shear V_{Rd}: single anchor, no edge effects, without lever arm								
Non-cracked concrete										
HIT-V 5.8 [kN]		7,2	12,0	16,8	31,2	48,8	63,3	75,6	88,5	
HIT-V 8.8 [kN]		12,0	18,4	27,2	48,2	57,5	63,3	75,6	88,5	
HIT-V-R [kN]		8,3	12,8	19,2	35,3	55,1	63,3	48,3	58,8	
HIT-V-HCR [kN]		12,0	18,4	27,2	48,2	57,5	63,3	75,6	88,5	
Cracked concrete										
HIT-V 5.8 [kN]		7,2	12,0	16,8	31,2	41,0	45,1	53,9	63,1	
HIT-V 8.8 [kN]		12,0	15,1	27,2	34,3	41,0	45,1	53,9	63,1	
HIT-V-R [kN]		8,3	12,8	19,2	34,3	41,0	45,1	48,3	58,8	
HIT-V-HCR [kN]	12,0	15,1	27,2	34,3	41,0	45,1	53,9	63,1		

Design resistance: concrete C 20/25 – $f_{ck,cube} = 25 \text{ N/mm}^2$ - minimum embedment depth

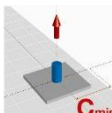
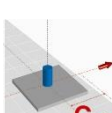
Anchor size		M8	M10	M12	M16	M20	M24	M27	M30	
Embedment depth $h_{ef} = h_{ef,min}$ [mm]		60	60	70	80	90	96	108	120	
Base material thickness $h = h_{min}$ [mm]		90	90	100	116	134	152	168	190	
Edge distance $c = c_{min}$ [mm]		40	50	60	80	100	120	135	150	
	Tensile N_{Rd}: single anchor, min. edge distance ($c = c_{min}$)									
	Non-cracked concrete									
	HIT-V 5.8 / 8.8 [kN]	7,1	7,8	9,7	12,8	16,5	20,7	24,2	28,9	
	HIT-V-R / -HCR [kN]									
	Cracked concrete									
	HIT-V 5.8 / 8.8 [kN]	3,0	4,2	8,0	10,7	13,7	16,4	19,5	22,9	
HIT-V-R / -HCR [kN]										
	Shear V_{Rd}: single anchor, min. edge distance ($c = c_{min}$), without lever arm									
	Non-cracked concrete									
	HIT-V 5.8 / 8.8 [kN]	3,5	4,9	6,6	10,2	13,9	17,9	21,5	25,9	
	HIT-V-R / -HCR [kN]									
	Cracked concrete									
	HIT-V 5.8 / 8.8 [kN]	2,5	3,5	4,7	7,2	9,9	12,7	15,3	18,3	
HIT-V-R / -HCR [kN]										

Design resistance: concrete C 20/25 – $f_{ck,cube} = 25 \text{ N/mm}^2$ - minimum embedment depth
(load values are valid for single anchor)

Anchor size		M8	M10	M12	M16	M20	M24	M27	M30
Embedment depth $h_{ef} = h_{ef,min}$ [mm]		60	60	70	80	90	96	108	120
Base material thickness $h = h_{min}$ [mm]		90	90	100	116	134	152	168	190
Spacing $s = s_{min}$ [mm]		40	50	60	80	100	120	135	150
	Tensile N_{Rd}: double anchor, no edge effects, min. spacing ($s = s_{min}$)								
	Non-cracked concrete								
	HIT-V 5.8 / 8.8 [kN]	7,7	7,9	10,0	12,6	15,4	17,9	21,2	25,0
	HIT-V-R / -HCR [kN]								
	Cracked concrete								
	HIT-V 5.8 / 8.8 [kN]	3,5	4,4	7,5	9,5	11,7	13,3	15,9	18,6
	Shear V_{Rd}: double anchor, no edge effects, min. spacing ($s = s_{min}$), without lever arm								
	Non-cracked concrete								
	HIT-V 5.8 [kN]	7,2	12,0	16,8	31,2	39,4	44,9	53,5	62,7
	HIT-V 8.8 [kN]	12,0	18,4	25,4	32,1	39,4	44,9	53,5	62,7
	HIT-V-R [kN]	8,3	12,8	19,2	32,1	39,4	44,9	48,3	58,8
	HIT-V-HCR [kN]	12,0	18,4	25,4	32,1	39,4	44,9	53,5	62,7
	Cracked concrete								
	HIT-V 5.8 / 8.8 [kN]	7,2	9,6	16,8	22,9	28,1	32,0	38,2	44,7
	HIT-V-R / -HCR [kN]								

Design resistance: concrete C 20/25 – $f_{ck,cube} = 25 \text{ N/mm}^2$ - typical embedment depth

Anchor size		M8	M10	M12	M16	M20	M24	M27	M30
Embedment depth $h_{ef} = h_{ef,typ}$ [mm]		80	90	110	125	170	210	240	270
Base material thickness $h = h_{min}$ [mm]		110	120	140	161	214	266	300	340
	Tensile N_{Rd}: single anchor, no edge effects								
	Non-cracked concrete								
	HIT-V 5.8 [kN]	12,0	19,3	28,0	39,2	62,2	85,4	104,3	124,5
	HIT-V 8.8 [kN]	19,3	24,0	32,4	39,2	62,2	85,4	104,3	124,5
	HIT-V-R [kN]	13,9	21,9	31,6	39,2	62,2	85,4	80,4	98,3
	HIT-V-HCR [kN]	19,3	24,0	32,4	39,2	62,2	85,4	104,3	124,5
	Cracked concrete								
	HIT-V 5.8 / 8.8 [kN]	6,7	9,4	18,4	27,9	44,3	60,9	74,4	88,7
	HIT-V-R / -HCR [kN]								
	Shear V_{Rd}: single anchor, no edge effects, without lever arm								
	Non-cracked concrete								
	HIT-V 5.8 [kN]	7,2	12,0	16,8	31,2	48,8	70,4	92,0	112,0
	HIT-V 8.8 [kN]	12,0	18,4	27,2	50,4	78,4	112,8	147,2	179,2
	HIT-V-R [kN]	8,3	12,8	19,2	35,3	55,1	79,5	48,3	58,8
	HIT-V-HCR [kN]	12,0	18,4	27,2	50,4	78,4	70,9	92,0	110,3
	Cracked concrete								
HIT-V 5.8 [kN]	7,2	12,0	16,8	31,2	48,8	70,4	92,0	112,0	
HIT-V 8.8 [kN]	12,0	18,4	27,2	50,4	78,4	112,8	147,2	179,2	
HIT-V-R [kN]	8,3	12,8	19,2	35,3	55,1	79,5	48,3	58,8	
HIT-V-HCR [kN]	12,0	18,4	27,2	50,4	78,4	70,9	92,0	110,3	

Design resistance: concrete C 20/25 – $f_{ck,cube} = 25 \text{ N/mm}^2$ - typical embedment depth

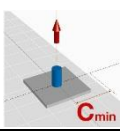
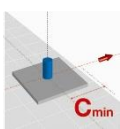
Anchor size		M8	M10	M12	M16	M20	M24	M27	M30	
Embedment depth $h_{ef} = h_{ef,typ}$ [mm]		80	90	110	125	170	210	240	270	
Base material thickness $h = h_{min}$ [mm]		110	120	140	161	214	266	300	340	
Edge distance $c = c_{min}$ [mm]		40	50	60	80	100	120	135	150	
	Tensile N_{Rd}: single anchor, min. edge distance ($c = c_{min}$)									
	Non-cracked concrete									
	HIT-V 5.8 / 8.8 HIT-V-R / -HCR [kN]	9,6	11,6	15,5	19,9	30,5	41,5	50,5	60,0	
	Cracked concrete									
	HIT-V 5.8 / 8.8 HIT-V-R / -HCR [kN]	3,6	5,2	10,2	16,5	25,2	34,2	41,5	49,3	
		Shear V_{Rd}: single anchor, min. edge distance ($c = c_{min}$), without lever arm								
Non-cracked concrete										
HIT-V 5.8 / 8.8 HIT-V-R / -HCR [kN]		3,7	5,3	7,3	11,5	17,2	23,6	29,0	34,8	
Cracked concrete										
HIT-V 5.8 / 8.8 HIT-V-R / -HCR [kN]		2,6	3,8	5,2	8,1	12,2	16,7	20,5	24,7	

**Design resistance: concrete C 20/25 – $f_{ck,cube} = 25 \text{ N/mm}^2$ - typical embedment depth
(load values are valid for single anchor)**

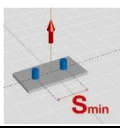
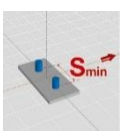
Anchor size		M8	M10	M12	M16	M20	M24	M27	M30	
Embedment depth $h_{ef} = h_{ef,typ}$ [mm]		80	90	110	125	170	210	240	270	
Base material thickness $h = h_{min}$ [mm]		110	120	140	161	214	266	300	340	
Spacing s [mm]		40	50	60	80	100	120	135	150	
	Tensile N_{Rd}: double anchor, no edge effects, min. spacing ($s = s_{min}$)									
	Non-cracked concrete									
	HIT-V 5.8 / 8.8 HIT-V-R / -HCR [kN]	11,2	13,5	18,1	22,4	35,1	48,1	58,6	69,9	
	Cracked concrete									
	HIT-V 5.8 / 8.8 HIT-V-R / -HCR [kN]	4,6	6,4	11,6	17,0	26,5	36,2	44,2	52,6	
		Shear V_{Rd}: double anchor, no edge effects, min. spacing ($s = s_{min}$), without lever arm								
Non-cracked concrete										
HIT-V 5.8 [kN]		7,2	12,0	16,8	31,2	48,8	70,4	92,0	112,0	
HIT-V 8.8 [kN]		12,0	18,4	27,2	50,4	78,4	112,8	147,2	177,0	
HIT-V-R [kN]		8,3	12,8	19,2	35,3	55,1	79,5	48,3	58,8	
HIT-V-HCR [kN]		12,0	18,4	27,2	50,4	78,4	70,9	92,0	110,3	
Cracked concrete										
HIT-V 5.8 [kN]		7,2	12,0	16,8	31,2	48,8	70,4	92,0	112,0	
HIT-V 8.8 [kN]		9,4	13,4	26,1	40,7	63,6	86,9	106,0	126,2	
HIT-V-R [kN]		8,3	12,8	19,2	35,3	55,1	79,5	48,3	58,8	
HIT-V-HCR [kN]	9,4	13,4	26,1	40,7	63,6	70,9	92,0	110,3		

Design resistance: concrete C 20/25 – $f_{ck,cube} = 25 \text{ N/mm}^2$ - embedment depth = 12 d^{a)}

Anchor size	M8	M10	M12	M16	M20	M24	M27	M30
Embedment depth $h_{ef} = 12 d^a)$ [mm]	96	120	144	192	240	288	324	360
Base material thickness $h = h_{min}$ [mm]	126	150	174	228	284	344	384	430
Tensile N_{Rd}: single anchor, no edge effects								
Non-cracked concrete								
HIT-V 5.8 [kN]	12,0	19,3	28,0	52,7	82,0	118,0	153,3	187,3
HIT-V 8.8 [kN]	19,3	30,7	44,7	74,6	104,3	137,1	163,6	191,6
HIT-V-R [kN]	13,9	21,9	31,6	58,8	92,0	132,1	80,4	98,3
HIT-V-HCR [kN]	19,3	30,7	44,7	74,6	104,3	117,6	152,9	187,1
Cracked concrete								
HIT-V 5.8 / 8.8 [kN]	8,0	12,6	24,1	42,9	67,0	96,5	116,6	136,6
HIT-V-R / -HCR [kN]	8,0	12,6	24,1	42,9	67,0	96,5	116,6	136,6
Shear V_{Rd}: single anchor, no edge effects, without lever arm								
Non-cracked concrete								
HIT-V 5.8 [kN]	7,2	12,0	16,8	31,2	48,8	70,4	92,0	112,0
HIT-V 8.8 [kN]	12,0	18,4	27,2	50,4	78,4	112,8	147,2	179,2
HIT-V-R [kN]	8,3	12,8	19,2	35,3	55,1	79,5	48,3	58,8
HIT-V-HCR [kN]	12,0	18,4	27,2	50,4	78,4	70,9	92,0	110,3
Cracked concrete								
HIT-V 5.8 [kN]	7,2	12,0	16,8	31,2	48,8	70,4	92,0	112,0
HIT-V 8.8 [kN]	12,0	18,4	27,2	50,4	78,4	112,8	147,2	179,2
HIT-V-R [kN]	8,3	12,8	19,2	35,3	55,1	79,5	48,3	58,8
HIT-V-HCR [kN]	12,0	18,4	27,2	50,4	78,4	70,9	92,0	110,3

a) d = element diameter

Design resistance: concrete C 20/25 – $f_{ck,cube} = 25 \text{ N/mm}^2$ - embedment depth = 12 d^{a)}

Anchor size	M8	M10	M12	M16	M20	M24	M27	M30
Embedment depth $h_{ef} = 12 d^a)$ [mm]	96	120	144	192	240	288	324	360
Base material thickness $h = h_{min}$ [mm]	126	150	174	228	284	344	384	430
Edge distance $c = c_{min}$ [mm]	40	50	60	80	100	120	135	150
Tensile N_{Rd}: single anchor, min. edge distance ($c = c_{min}$)								
Non-cracked concrete								
HIT-V 5.8 [kN]	11,8	16,5	21,7	33,4	46,7	61,3	73,2	85,7
HIT-V 8.8 [kN]	11,8	16,5	21,7	33,4	46,7	61,3	73,2	85,7
HIT-V-R [kN]	11,8	16,5	21,7	33,4	46,7	61,3	73,2	85,7
HIT-V-HCR [kN]	11,8	16,5	21,7	33,4	46,7	61,3	73,2	85,7
Cracked concrete								
HIT-V 5.8 / 8.8 [kN]	4,2	6,5	12,5	22,2	34,7	48,9	58,4	68,4
HIT-V-R / -HCR [kN]	4,2	6,5	12,5	22,2	34,7	48,9	58,4	68,4
Shear V_{Rd}: single anchor, min. edge distance ($c = c_{min}$), without lever arm								
Non-cracked concrete								
HIT-V 5.8 / 8.8 [kN]	3,9	5,7	7,8	12,9	18,9	25,9	31,8	38,1
HIT-V-R / -HCR [kN]	3,9	5,7	7,8	12,9	18,9	25,9	31,8	38,1
Cracked concrete								
HIT-V 5.8 / 8.8 [kN]	2,8	4,0	5,5	9,1	13,4	18,4	22,5	27,0
HIT-V-R / -HCR [kN]	2,8	4,0	5,5	9,1	13,4	18,4	22,5	27,0

a) d = element diameter

Design resistance: concrete C 20/25 – $f_{ck,cube} = 25 \text{ N/mm}^2$ - embedment depth = $12 d^a$
(load values are valid for single anchor)

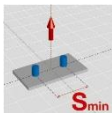
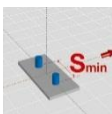
Anchor size		M8	M10	M12	M16	M20	M24	M27	M30	
Embedment depth $h_{ef} = 12 d^a$ [mm]		96	120	144	192	240	288	324	360	
Base material thickness $h = h_{min}$ [mm]		126	150	174	228	284	344	384	430	
Spacing $s = s_{min}$ [mm]		40	50	60	80	100	120	135	150	
	Tensile N_{Rd}: double anchor, no edge effects, min. spacing ($s = s_{min}$)									
	Non-cracked concrete									
	HIT-V 5.8 [kN]	12,0	19,3	26,5	40,8	57,0	74,9	89,4	104,6	
	HIT-V 8.8 [kN]	14,4	20,1	26,5	40,8	57,0	74,9	89,4	104,6	
	HIT-V-R [kN]	13,9	20,1	26,5	40,8	57,0	74,9	80,4	98,3	
	HIT-V-HCR [kN]	14,4	20,1	26,5	40,8	57,0	74,9	89,4	104,6	
	Cracked concrete									
	HIT-V 5.8 / 8.8 [kN]	5,5	8,5	15,4	26,5	40,1	55,7	66,4	77,8	
	HIT-V-R / -HCR [kN]									
		Shear V_{Rd}: double anchor, no edge effects, min. spacing ($s = s_{min}$), without lever arm								
Non-cracked concrete										
HIT-V 5.8 [kN]		7,2	12,0	16,8	31,2	48,8	70,4	92,0	112,0	
HIT-V 8.8 [kN]		12,0	18,4	27,2	50,4	78,4	112,8	147,2	179,2	
HIT-V-R [kN]		8,3	12,8	19,2	35,3	55,1	79,5	48,3	58,8	
HIT-V-HCR [kN]		12,0	18,4	27,2	50,4	78,4	70,9	92,0	110,3	
Cracked concrete										
HIT-V 5.8 [kN]		7,2	12,0	16,8	31,2	48,8	70,4	92,0	112,0	
HIT-V 8.8 [kN]		11,0	17,2	27,2	50,4	78,4	112,8	147,2	179,2	
HIT-V-R [kN]		8,3	12,8	19,2	35,3	55,1	79,5	48,3	58,8	
HIT-V-HCR [kN]	11,0	17,2	27,2	50,4	78,4	70,9	92,0	110,3		

a) d = element diameter

Seismic design C1

Basic loading data for concrete C20/25 – C50/60

All data in this section applies to:

- Seismic design according to TR045

The following technical data are based on: ETA-11/0493 and ETA-12/0084, issue 2013-06-20

Anchorage depth range

Anchor size		M8	M10	M12	M16	M20	M24	M27	M30
Effective anchorage	$h_{ef,min}$ [mm]	60	60	70	80	90	96	108	120
depth range	$h_{ef,max}$ [mm]	160	200	240	320	400	480	540	600

Tension resistance in case of seismic performance category C1

Anchor size		M8	M10	M12	M16	M20	M24	M27	M30
Characteristic tension resistance to steel failure									
HIT-V-5.8(F)	$N_{Rk,s,seis}$ [kN]	-	29	42	79	123	177	230	281
HIT-V-8.8(F)	$N_{Rk,s,seis}$ [kN]	-	46	67	126	196	282	367	449
Partial safety factor	$\gamma_{Ms,seis}$ [-]	1,5							
HIT-V-R	$N_{Rk,s,seis}$ [kN]	-	41	59	110	172	247	230	281
Partial safety factor	$\gamma_{Ms,seis}$ [-]	1,87						2,86	
HIT-V-HCR	$N_{Rk,s,seis}$ [kN]	-	46	67	126	196	247	321	393
Partial safety factor	$\gamma_{Ms,seis}$ [-]	1,5					2,1		
Characteristic bond resistance in cracked concrete C20/25 to C50/60									
Temperature range I: 40°C/24°C	$\tau_{Rk,seis}$ [N/mm ²]	-	5,2	7,0					
Temperature range II: 80°C/50°C	$\tau_{Rk,seis}$ [N/mm ²]	-	3,9	5,7					
Temperature range III: 120°C/72°C	$\tau_{Rk,seis}$ [N/mm ²]	-	3,5	4,8					
Partial safety factor	$\gamma_{Mp,seis}$ [-]	1,8							
Concrete cone resistance and splitting resistance									
Partial safety factor	$\gamma_{Mc,seis} = \gamma_{Msp,seis}$ [-]	1,8							

Displacement under tension load in case of seismic performance category C1 ¹⁾

Anchor size		M8	M10	M12	M16	M20	M24	M27	M30
Displacement ¹⁾	$\delta_{N,seis}$ [mm]	-	0,8	0,8	0,8	0,8	0,8	0,8	0,8

1) Maximum displacement during cycling (seismic event).

Shear resistance in case of seismic performance category C1

Anchor size		M8	M10	M12	M16	M20	M24	M27	M30
Characteristic shear resistance to steel failure									
for HIT-V-5.8(F)	$V_{Rk,s,seis}$ [kN]	-	11	15	27	43	62	81	98
for HIT-V-8.8(F)	$V_{Rk,s,seis}$ [kN]	-	16	24	44	69	99	129	157
Partial safety factor	$\gamma_{Ms,seis}$ [-]	1,25							
for HIT-V-R	$V_{Rk,s,seis}$ [kN]	-	14	21	39	60	87	81	98
Partial safety factor	$\gamma_{Ms,seis}$ [-]	1,56						2,38	
for HIT-V-HCR	$V_{Rk,s,seis}$ [kN]	-	16	24	44	69	87	113	137
Partial safety factor	$\gamma_{Ms,seis}$ [-]	1,25					1,75		
Concrete pryout resistance and concrete edge resistance									
Partial safety factor	$\gamma_{Mcp,seis} = \gamma_{Mc,seis}$ [-]	1,5							

Displacement under shear load in case of seismic performance category C1 ¹⁾

Anchor size		M8	M10	M12	M16	M20	M24	M27	M30
Displacement ¹⁾	$\delta_{V,seis}$ [mm]	-	3,5	3,8	4,4	5,0	5,6	6,1	6,5

1) Maximum displacement during cycling (seismic event).

For seismic resistant fastening applications please use the anchor design software PROFIS Anchor.

Hilti HIT-HY 200 mortar with HIS-(R)N sleeve

Injection mortar system		Benefits
	Hilti HIT-HY 200-A 500 ml foil pack (also available as 330 ml)	<ul style="list-style-type: none"> - SAFEset technology: drilling and borehole cleaning in one step with Hilti hollow drill bit - Suitable for cracked and non-cracked concrete C 20/25 to C 50/60. - ETA seismic approval C1 - High loading capacity, excellent handling, and fast curing - Small edge distance and anchor spacing possible - Corrosion resistant - In service temperature range up to 120°C short term/72°C long term - Manual cleaning for anchor size M8 and M10 - Two mortar (A and R) versions available with different curing times and same performance
	Hilti HIT-HY 200-R 500 ml foil pack (also available as 330 ml)	
	Static mixer	
	Internal threaded sleeve HIS-N HIS-RN	



Concrete



Tensile zone

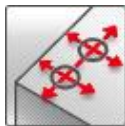

Small edge distance and spacing

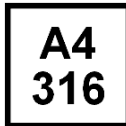

Corrosion resistance



Approved automatic cleaning while drilling

SAFEset

Hilti **SAFEset** technology with hollow drill bit



European Technical Approval



CE conformity



PROFIS Anchor design software

Approvals / certificates

Description	Authority / Laboratory	No. / date of issue
European technical approval ^{a)}	DIBt, Berlin	ETA-11/0493 / 2013-06-20 (Hilti HIT-HY 200-A) ETA-12/0084 / 2013-06-08 (Hilti HIT-HY 200-R)

a) All data given in this section according ETA-11/0493 and ETA-12/0084, issue 2013-06-20.

Basic loading data (for a single anchor)

All data in this section applies to

For details see Simplified design method

- Correct setting (See setting instruction)
- No edge distance and spacing influence
- Steel failure
- Base material thickness, as specified in the table
- One anchor material, as specified in the tables
- Concrete C 20/25, $f_{ck,cube} = 25 \text{ N/mm}^2$
- Temperature range I
(min. base material temperature -40°C , max. long term/short term base material temperature: $+24^\circ\text{C}/40^\circ\text{C}$)
- Installation temperature range -10°C to $+40^\circ\text{C}$

Embedment depth and base material thickness for the basic loading data. Mean ultimate resistance, characteristic resistance, design resistance, recommended loads.

Anchor size		M8x90	M10x110	M12x125	M16x170	M20x205
Embedment depth	h_{ef} [mm]	90	110	125	170	205
Base material thickness	h [mm]	120	150	170	230	270

Mean ultimate resistance: concrete C 20/25 , anchor HIS-N with screw 8.8

Anchor size		M8x90	M10x110	M12x125	M16x170	M20x205
Non cracked concrete						
Tensile $N_{Ru,m}$	HIS-N [kN]	26,3	48,3	70,4	123,9	114,5
Shear $V_{Ru,m}$	HIS-N [kN]	13,7	24,2	41,0	62,0	57,8
Cracked concrete						
Tensile $N_{Ru,m}$	HIS-N [kN]	26,3	48,3	66,8	105,9	114,5
Shear $V_{Ru,m}$	HIS-N [kN]	13,7	24,2	41,0	62,0	57,8

Characteristic resistance: concrete C 20/25 , anchor HIS-N with screw 8.8

Anchor size		M8x90	M10x110	M12x125	M16x170	M20x205
Non cracked concrete						
Tensile N_{Rk}	HIS-N [kN]	25,0	46,0	67,0	111,9	109,0
Shear V_{Rk}	HIS-N [kN]	13,0	23,0	39,0	59,0	55,0
Cracked concrete						
Tensile N_{Rk}	HIS-N [kN]	24,7	39,9	50,3	79,8	105,7
Shear V_{Rk}	HIS-N [kN]	13,0	23,0	39,0	59,0	55,0

Design resistance: concrete C 20/25 , anchor HIS-N with screw 8.8

Anchor size		M8x90	M10x110	M12x125	M16x170	M20x205
Cracked concrete						
Tensile N_{Rd}	HIS-N [kN]	17,5	30,7	44,7	74,6	74,1
Shear V_{Rd}	HIS-N [kN]	10,4	18,4	26,0	39,3	36,7
Non cracked concrete						
Tensile N_{Rd}	HIS-N [kN]	16,5	26,6	33,5	53,2	70,4
Shear V_{Rd}	HIS-N [kN]	10,4	18,4	26,0	39,3	36,7

Recommended loads ^{a)}: concrete C 20/25 , anchor HIS-N with screw 8.8

Anchor size			M8x90	M10x110	M12x125	M16x170	M20x205
Non cracked concrete							
Tensile N _{rec}	HIS-N	[kN]	12,5	27,9	31,9	53,3	53,0
Shear V _{rec}	HIS-N	[kN]	7,4	13,1	18,6	28,1	26,2
Cracked concrete							
Tensile N _{rec}	HIS-N	[kN]	11,8	19,0	24,0	38,0	50,3
Shear V _{rec}	HIS-N	[kN]	7,4	13,1	18,6	28,1	26,2

a) With overall partial safety factor for action $\gamma = 1,4$. The partial safety factors for action depend on the type of loading and shall be taken from national regulations.

Service temperature range

Hilti HIT-HY 200 injection mortar may be applied in the temperature ranges given below. An elevated base material temperature may lead to a reduction of the design bond resistance.

Temperature range	Base material temperature	Maximum long term base material temperature	Maximum short term base material temperature
Temperature range I	-40 °C to +40 °C	+24 °C	+40 °C
Temperature range II	-40 °C to +80 °C	+50 °C	+80 °C
Temperature range III	-40 °C to +120 °C	+72 °C	+120 °C

Max short term base material temperature

Short-term elevated base material temperatures are those that occur over brief intervals, e.g. as a result of diurnal cycling.

Max long term base material temperature

Long-term elevated base material temperatures are roughly constant over significant periods of time.

Materials

Mechanical properties of HIS-(R)N

Anchor size			M8x90	M10x110	M12x125	M16x170	M20x205
Nominal tensile strength f _{uk}	HIS-N	[N/mm ²]	490	460	460	460	460
	Screw 8.8	[N/mm ²]	800	800	800	800	800
	HIS-RN	[N/mm ²]	700	700	700	700	700
	Screw A4-70	[N/mm ²]	700	700	700	700	700
Yield strength f _{yk}	HIS-N	[N/mm ²]	410	375	375	375	375
	Screw 8.8	[N/mm ²]	640	640	640	640	640
	HIS-RN	[N/mm ²]	350	350	350	350	350
	Screw A4-70	[N/mm ²]	450	450	450	450	450
Stressed cross-section A _s	HIS-(R)N	[mm ²]	51,5	108,0	169,1	256,1	237,6
	Screw	[mm ²]	36,6	58	84,3	157	245
Moment of resistance W	HIS-(R)N	[mm ³]	145	430	840	1595	1543
	Screw	[mm ³]	31,2	62,3	109	277	541

Material quality

Part	Material
Internal threaded sleeve ^{a)} HIS-N	C-steel 1.0718, Steel galvanized $\geq 5\mu\text{m}$
Internal threaded sleeve ^{b)} HIS-RN	Stainless steel 1.4401 and 1.4571

- a) related fastening screw: strength class 8.8, A5 > 8% Ductile
steel galvanized $\geq 5\mu\text{m}$
- b) related fastening screw: strength class 70, A5 > 8% Ductile
stainless steel 1.4401; 1.4404; 1.4578; 1.4571; 1.4439; 1.4362

Anchor dimensions

Anchor size	M8x90	M10x110	M12x125	M16x170	M20x205
Internal threaded sleeve HIS-N / HIS-RN					
Embedment depth h_{ef} [mm]	90	110	125	170	205

Setting

installation equipment

Anchor size	M8x90	M10x110	M12x125	M16x170	M20x205
Rotary hammer	TE 2 – TE 16		TE 40 – TE 70		
Other tools	compressed air gun or blow out pump, set of cleaning brushes, dispenser				

Setting instruction

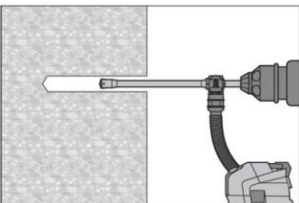
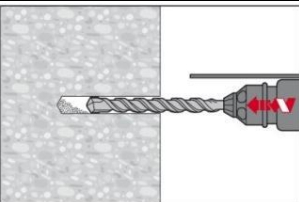
Bore hole drilling	
	Drill hole to the required embedment depth with an appropriately sized Hilti TE-CD or TE-YD hollow drill bit with Hilti vacuum attachment. This drilling method properly cleans the borehole and removes dust while drilling. After drilling is complete, proceed to the "injection preparation" step in the instructions for use.
	Drill Hole to the required embedment depth with a hammer drill set in rotation-hammer mode using an appropriately sized carbide drill bit.

Bore hole cleaning Just before setting an anchor, the bore hole must be free of dust and debris.

a) Manual Cleaning (MC) non-cracked concrete only

for bore hole diameters $d_0 \leq 20\text{mm}$ and bore hole depth $h_0 \leq 10d$

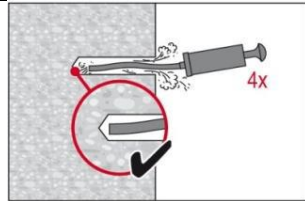

The Hilti manual pump may be used for blowing out bore holes up to diameters $d_0 \leq 20\text{ mm}$ and embedment depths up to $h_{ef} \leq 10d$. Blow out at least 4 times from the back of the bore hole until return air stream is free of noticeable dust

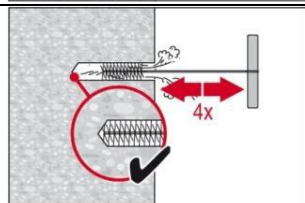

Brush 4 times with the specified brush size by inserting the steel brush Hilti HIT-RB to the back of the hole (if needed with extension) in a twisting motion and removing it. The brush must produce natural resistance as it enters the bore hole -- if not the brush is too small and must be replaced with the proper brush diameter.

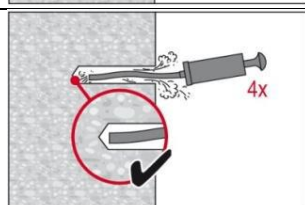

Blow out again with manual pump at least 4 times until return air stream is free of noticeable dust.

b) Compressed air cleaning (CAC)

for all bore hole diameters d_0 and all bore hole depth h_0

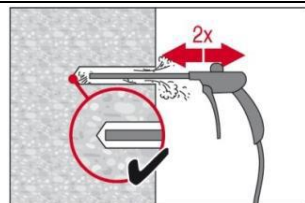

Blow 2 times from the back of the hole (if needed with nozzle extension) over the hole length with oil-free compressed air (min. 6 bar at 6 m³/h) until return air stream is free of noticeable dust.

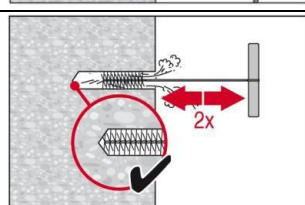

Brush 2 times with the specified brush size by inserting the steel brush Hilti HIT-RB to the back of the hole (if needed with extension) in a twisting motion and removing it. The brush must produce natural resistance as it enters the bore hole -- if not the brush is too small and must be replaced with the proper brush diameter.

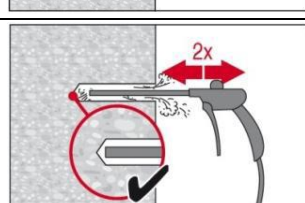

Blow again with compressed air 2 times until return air stream is free of noticeable dust.

Injection preparation

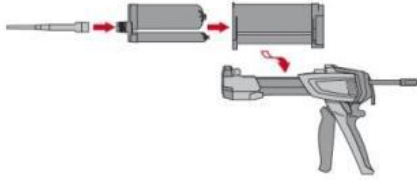

Tightly attach new Hilti mixing nozzle HIT-RE-M to foil pack manifold (snug fit). Do not modify the mixing nozzle. Observe the instruction for use of the dispenser. Check foil pack holder for proper function. Do not use damaged foil packs / holders. Swing foil pack holder with foil pack into HIT-dispenser.

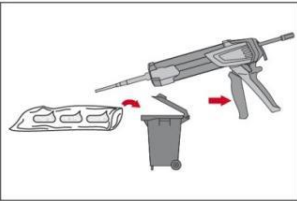

Discard initial adhesive. The foil pack opens automatically as dispensing is initiated. Depending on the size of the foil pack an initial amount of adhesive has to be discarded.

Discard quantities are:

- 2 strokes for 330 ml foil pack,
- 3 strokes for 500 ml foil pack,
- 4 strokes for 500 ml foil pack $\leq 5^{\circ}\text{C}$.

Inject adhesive from the back of the borehole without forming air voids

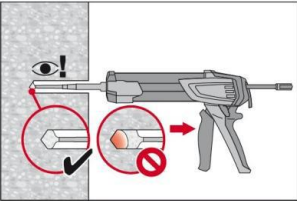

Inject the adhesive starting at the back of the hole, slowly withdrawing the mixer with each trigger pull. Fill holes approximately 2/3 full, or as required to ensure that the annular gap between the anchor and the concrete is completely filled with adhesive along the embedment length.

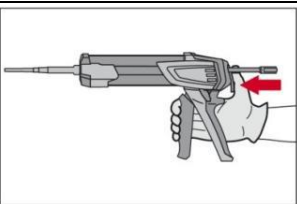

After injection is completed, depressurize the dispenser by pressing the release trigger. This will prevent further adhesive discharge from the mixer.

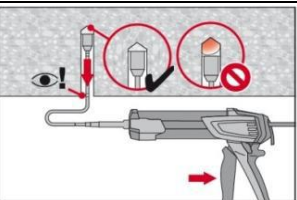

Overhead installation and/or installation with embedment depth $h_{ef} > 250\text{mm}$. For overhead installation the injection is only possible with the aid of extensions and piston plugs. Assemble HIT-RE-M mixer, extension(s) and appropriately sized piston plug. Insert piston plug to back of the hole and inject adhesive. During injection the piston plug will be naturally extruded out of the bore hole by the adhesive pressure.

Setting the element

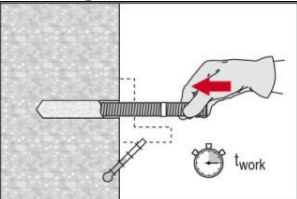

Before use, verify that the element is dry and free of oil and other contaminants. Mark and set element to the required embedment depth until working time t_{work} has elapsed.

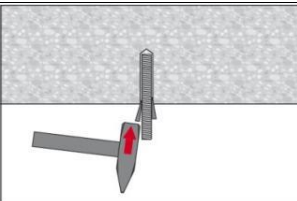

For overhead installation use piston plugs and fix embedded parts with e.g. wedges

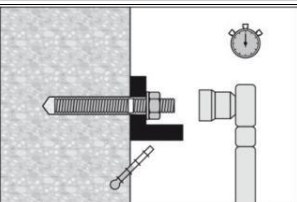

Loading the anchor:
After required curing time t_{cure} the anchor can be loaded.
The applied installation torque shall not exceed T_{max} .

For detailed information on installation see instruction for use given with the package of the product.

Working time, curing time

Temperature of the base material	Hilti HIT-HY 200-R	
	Working time in which anchor can be inserted and adjusted t_{work}	Curing time before anchor can be fully loaded t_{cure}
-10 °C to -5 °C	3 hour	20 hour
-4 °C to 0 °C	2 hour	8 hour
1 °C to 5 °C	1 hour	4 hour
6 °C to 10 °C	40 min	2,5 hour
11 °C to 20 °C	15 min	1,5 hour
21 °C to 30 °C	9 min	1 hour
31 °C to 40 °C	6 min	1 hour

Temperature of the base material	Hilti HIT-HY 200-A	
	Working time in which anchor can be inserted and adjusted t_{work}	Curing time before anchor can be fully loaded t_{cure}
-10 °C to -5 °C	1,5 hour	7 hour
-4 °C to 0 °C	50 min	4 hour
1 °C to 5 °C	25 min	2 hour
6 °C to 10 °C	15 min	75 min
11 °C to 20 °C	7 min	45 min
21 °C to 30 °C	4 min	30 min
31 °C to 40 °C	3 min	30 min

Setting details

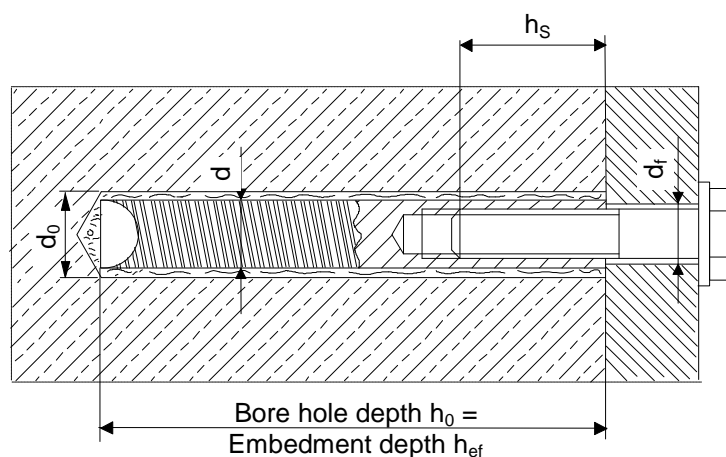

Anchor size			M8x90	M10x110	M12x125	M16x170	M20x205
Nominal diameter of drill bit	d_0	[mm]	14	18	22	28	32
Diameter of element	d	[mm]	12,5	16,5	20,5	25,4	27,6
Effective anchorage and drill hole depth	h_{ef}	[mm]	90	110	125	170	205
Minimum base material thickness	h_{min}	[mm]	120	150	170	230	270
Diameter of clearance hole in the fixture	d_f	[mm]	9	12	14	18	22
Thread engagement length; min - max	h_s	[mm]	8-20	10-25	12-30	16-40	20-50
Torque moment ^{a)}	T_{max}	[Nm]	10	20	40	80	150
Minimum spacing	s_{min}	[mm]	40	45	55	65	90
Minimum edge distance	c_{min}	[mm]	40	45	55	65	90
Critical spacing for splitting failure	$s_{cr,sp}$	[mm]	$2 c_{cr,sp}$				
Critical edge distance for splitting failure ^{b)}	$c_{cr,sp}$	[mm]	$1,0 \cdot h_{ef}$ for $h / h_{ef} \geq 2,0$				
			$4,6 h_{ef} - 1,8 h$ for $2,0 > h / h_{ef} > 1,3$				
			$2,26 h_{ef}$ for $h / h_{ef} \leq 1,3$				
Critical spacing for concrete cone failure	$s_{cr,N}$	[mm]	$2 c_{cr,N}$				
Critical edge distance for concrete cone failure ^{c)}	$c_{cr,N}$	[mm]	$1,5 h_{ef}$				

For spacing (or edge distance) smaller than critical spacing (or critical edge distance) the design loads have to be reduced.

- Maximum recommended torque moment to avoid splitting failure during installation with minimum spacing and/or edge distance.
- h : base material thickness ($h \geq h_{min}$), h_{ef} : embedment depth
- The critical edge distance for concrete cone failure depends on the embedment depth h_{ef} and the design bond resistance. The simplified formula given in this table is on the safe side.

Simplified design method

Simplified version of the design method according ETAG 001, TR 029. Design resistance according data given in ETA-11/0493 issued 2013-06-20 for HIT-HY 200-A and ETA-12/0084 issued 2013-06-20 for HIT-HY 200-R. Both mortars possess identical technical load performance.

- Influence of concrete strength
- Influence of edge distance
- Influence of spacing
- Valid for a group of two anchors. (The method may also be applied for anchor groups with more than two anchors or more than one edge distance. The influencing factors must then be considered for each edge distance and spacing. The simplified calculated design loads take a conservative approach: They will be lower than the exact values according to ETAG 001, TR 029. For an optimized design, anchor calculation can be performed using PROFIS anchor design software.

The design method is based on the following simplification:

- No different loads are acting on individual anchors (no eccentricity)

The values are valid for one anchor.

For more complex fastening applications please use the anchor design software PROFIS Anchor.

Tension loading

The design tensile resistance is the lower value of

- Steel resistance: $N_{Rd,s}$
- Combined pull-out and concrete cone resistance: $N_{Rd,p} = N_{Rd,p}^0 \cdot f_{B,p} \cdot f_{1,N} \cdot f_{2,N} \cdot f_{3,N} \cdot f_{h,p} \cdot f_{re,N}$
- Concrete cone resistance: $N_{Rd,c} = N_{Rd,c}^0 \cdot f_B \cdot f_{1,N} \cdot f_{2,N} \cdot f_{3,N} \cdot f_{h,N} \cdot f_{re,N}$
- Concrete splitting resistance (only non-cracked concrete): $N_{Rd,sp} = N_{Rd,c}^0 \cdot f_B \cdot f_{1,sp} \cdot f_{2,sp} \cdot f_{3,sp} \cdot f_{h,N} \cdot f_{re,N}$

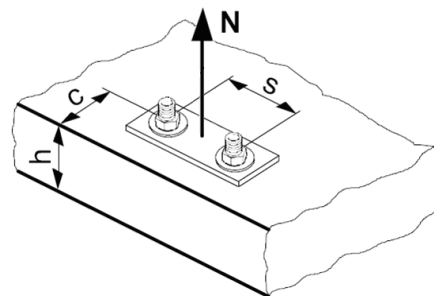

Basic design tensile resistance

Design steel resistance $N_{Rd,s}$

Anchor size		M8x90	M10x110	M12x125	M16x170	M20x205
$N_{Rd,s}$	HIS-N with screw 8.8 [kN]	17,5	30,7	44,7	80,3	74,1
	HIS-RN with screw A4-70 [kN]	13,9	21,9	31,6	58,8	69,2

Design combined pull-out and concrete cone resistance

$$N_{Rd,p} = N_{Rd,p}^0 \cdot f_{B,p} \cdot f_{1,N} \cdot f_{2,N} \cdot f_{3,N} \cdot f_{h,p} \cdot f_{re,N}$$

Anchor size		M8x90	M10x110	M12x125	M16x170	M20x205
Embedment depth	h_{ef} [mm]	90	110	125	170	205
Non cracked concrete						
$N_{Rd,p}^0$	Temperature range I [kN]	30,6	49,4	69,8	117,6	154,7
$N_{Rd,p}^0$	Temperature range II [kN]	25,9	41,8	59,0	99,5	130,4
$N_{Rd,p}^0$	Temperature range III [kN]	22,4	36,1	51,0	85,9	112,6
Cracked concrete						
$N_{Rd,p}^0$	Temperature range I [kN]	16,5	26,6	37,6	63,3	83,0
$N_{Rd,p}^0$	Temperature range II [kN]	13,0	20,9	29,5	49,7	65,2
$N_{Rd,p}^0$	Temperature range III [kN]	11,8	19,0	26,8	45,2	59,3

$$\text{Design concrete cone resistance } N_{Rd,c} = N_{Rd,c}^0 \cdot f_B \cdot f_{1,N} \cdot f_{2,N} \cdot f_{3,N} \cdot f_{h,N} \cdot f_{re,N}$$

$$\text{Design splitting resistance } N_{Rd,sp} = N_{Rd,c}^0 \cdot f_B \cdot f_{1,sp} \cdot f_{2,sp} \cdot f_{3,sp} \cdot f_{h,N} \cdot f_{re,N}$$

Anchor size		M8	M10	M12	M16	M20
Non cracked concrete						
$N_{Rd,c}^0$	[kN]	28,7	38,8	47,1	74,6	98,8
Cracked concrete						
$N_{Rd,c}^0$	[kN]	20,5	27,7	33,5	53,2	70,4

a) Splitting resistance must only be considered for non-cracked concrete.

Influencing factors

Influence of concrete strength on combined pull-out and concrete cone resistance

Concrete strength designation (ENV 206)	C 20/25	C 25/30	C 30/37	C 35/45	C 40/50	C 45/55	C 50/60
$f_{B,p} = (f_{ck,cube}/25N/mm^2)^{0,10}$ a)	$f_{B,p} = 1$						

a) $f_{ck,cube}$ = concrete compressive strength, measured on cubes with 150 mm side length

Influence of embedment depth on combined pull-out and concrete cone resistance

$f_{h,p} = 1$

Influence of concrete strength on concrete cone resistance

Concrete strength designation (ENV 206)	C 20/25	C 25/30	C 30/37	C 35/45	C 40/50	C 45/55	C 50/60
$f_B = (f_{ck,cube}/25N/mm^2)^{0,5}$ a)	1	1,1	1,22	1,34	1,41	1,48	1,55

a) $f_{ck,cube}$ = concrete compressive strength, measured on cubes with 150 mm side length

Influence of edge distance a)

$c/c_{cr,N}$	0,1	0,2	0,3	0,4	0,5	0,6	0,7	0,8	0,9	1
$c/c_{cr,sp}$										
$f_{1,N} = 0,7 + 0,3 \cdot c/c_{cr,N} \leq 1$	0,73	0,76	0,79	0,82	0,85	0,88	0,91	0,94	0,97	1
$f_{1,sp} = 0,7 + 0,3 \cdot c/c_{cr,sp} \leq 1$										
$f_{2,N} = 0,5 \cdot (1 + c/c_{cr,N}) \leq 1$	0,55	0,60	0,65	0,70	0,75	0,80	0,85	0,90	0,95	1
$f_{2,sp} = 0,5 \cdot (1 + c/c_{cr,sp}) \leq 1$										

a) The edge distance shall not be smaller than the minimum edge distance c_{min} . These influencing factors must be considered for every edge distance smaller than the critical edge distance.

Influence of anchor spacing ^{a)}

$s/s_{cr,N}$	0,1	0,2	0,3	0,4	0,5	0,6	0,7	0,8	0,9	1
$s/s_{cr,sp}$										
$f_{3,N} = 0,5 \cdot (1 + s/s_{cr,N}) \leq 1$	0,55	0,60	0,65	0,70	0,75	0,80	0,85	0,90	0,95	1
$f_{3,sp} = 0,5 \cdot (1 + s/s_{cr,sp}) \leq 1$										

a) The anchor spacing shall not be smaller than the minimum anchor spacing s_{min} . This influencing factor must be considered for every anchor spacing.

Influence of embedment depth on concrete cone resistance

$f_{h,N} = 1$

Influence of reinforcement

h_{ef} [mm]	40	50	60	70	80	90	≥ 100
$f_{re,N} = 0,5 + h_{ef}/200\text{mm} \leq 1$	0,7 ^{a)}	0,75 ^{a)}	0,8 ^{a)}	0,85 ^{a)}	0,9 ^{a)}	0,95 ^{a)}	1

a) This factor applies only for dense reinforcement. If in the area of anchorage there is reinforcement with a spacing ≥ 150 mm (any diameter) or with a diameter ≤ 10 mm and a spacing ≥ 100 mm, then a factor $f_{re,N} = 1$ may be applied.

Shear loading

The design shear resistance is the lower value of

- Steel resistance: $V_{Rd,s}$
- Concrete pryout resistance: $V_{Rd,cp} = k \cdot \text{lower value of } N_{Rd,p} \text{ and } N_{Rd,c}$
- Concrete edge resistance: $V_{Rd,c} = V_{Rd,c}^0 \cdot f_B \cdot f_{\beta} \cdot f_h \cdot f_4 \cdot f_{hef} \cdot f_c$

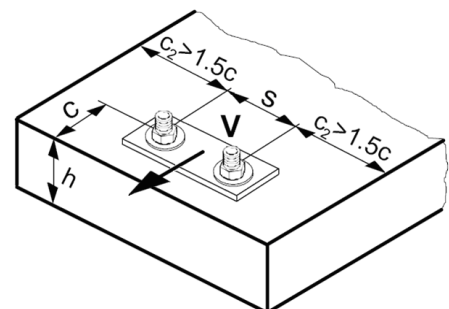

Basic design shear resistance

Design steel resistance $V_{Rd,s}$

Anchor size		M8x90	M10x110	M12x125	M16x170	M20x205
$V_{Rd,s}$	HIS-N with screw 8.8 [kN]	10,4	18,4	26,0	39,3	36,7
	HIS-RN with screw A4-70 [kN]	8,3	12,8	19,2	35,3	41,5

Design concrete pryout resistance $V_{Rd,cp} = \text{lower value}^a)$ of $k \cdot N_{Rd,p}$ and $k \cdot N_{Rd,c}$

$k = 2$

- a) $N_{Rd,p}$: Design combined pull-out and concrete cone resistance
 $N_{Rd,c}$: Design concrete cone resistance

Design concrete edge resistance $V_{Rd,c} = V_{Rd,c}^0 \cdot f_B \cdot f_\beta \cdot f_h \cdot f_4 \cdot f_{hef} \cdot f_c$

Anchor size		M8	M10	M12	M16	M20
Non-cracked concrete						
$V_{Rd,c}^0$ [kN]		12,4	19,6	28,2	40,2	46,2
Cracked concrete						
$V_{Rd,c}^0$ [kN]		8,8	13,9	20,0	28,5	32,7

Influencing factors

Influence of concrete strength

Concrete strength designation (ENV 206)	C 20/25	C 25/30	C 30/37	C 35/45	C 40/50	C 45/55	C 50/60
$f_B = (f_{ck,cube}/25N/mm^2)^{1/2}$ a)	1	1,1	1,22	1,34	1,41	1,48	1,55

a) $f_{ck,cube}$ = concrete compressive strength, measured on cubes with 150 mm side length

Influence of angle between load applied and the direction perpendicular to the free edge

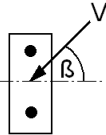
Angle β	0°	10°	20°	30°	40°	50°	60°	70°	80°	≥ 90°
$f_\beta = \frac{1}{\sqrt{(\cos \alpha_v)^2 + \left(\frac{\sin \alpha_v}{2,5}\right)^2}}$ 	1	1,01	1,05	1,13	1,24	1,40	1,64	1,97	2,32	2,50

Influence of base material thickness

h/c	0,15	0,3	0,45	0,6	0,75	0,9	1,05	1,2	1,35	≥ 1,5
$f_h = \{h/(1,5 \cdot c)\}^{1/2} \leq 1$	0,32	0,45	0,55	0,63	0,71	0,77	0,84	0,89	0,95	1,00

Influence of anchor spacing and edge distance ^{a)} for concrete edge resistance: f_4
 $f_4 = (c/h_{ef})^{1,5} \cdot (1 + s / [3 \cdot c]) \cdot 0,5$

c/h _{ef}	Single anchor	Group of two anchors s/h _{ef}														
		0,75	1,50	2,25	3,00	3,75	4,50	5,25	6,00	6,75	7,50	8,25	9,00	9,75	10,50	11,25
0,50	0,35	0,27	0,35	0,35	0,35	0,35	0,35	0,35	0,35	0,35	0,35	0,35	0,35	0,35	0,35	0,35
0,75	0,65	0,43	0,54	0,65	0,65	0,65	0,65	0,65	0,65	0,65	0,65	0,65	0,65	0,65	0,65	0,65
1,00	1,00	0,63	0,75	0,88	1,00	1,00	1,00	1,00	1,00	1,00	1,00	1,00	1,00	1,00	1,00	1,00
1,25	1,40	0,84	0,98	1,12	1,26	1,40	1,40	1,40	1,40	1,40	1,40	1,40	1,40	1,40	1,40	1,40
1,50	1,84	1,07	1,22	1,38	1,53	1,68	1,84	1,84	1,84	1,84	1,84	1,84	1,84	1,84	1,84	1,84
1,75	2,32	1,32	1,49	1,65	1,82	1,98	2,15	2,32	2,32	2,32	2,32	2,32	2,32	2,32	2,32	2,32
2,00	2,83	1,59	1,77	1,94	2,12	2,30	2,47	2,65	2,83	2,83	2,83	2,83	2,83	2,83	2,83	2,83
2,25	3,38	1,88	2,06	2,25	2,44	2,63	2,81	3,00	3,19	3,38	3,38	3,38	3,38	3,38	3,38	3,38
2,50	3,95	2,17	2,37	2,57	2,77	2,96	3,16	3,36	3,56	3,76	3,95	3,95	3,95	3,95	3,95	3,95
2,75	4,56	2,49	2,69	2,90	3,11	3,32	3,52	3,73	3,94	4,15	4,35	4,56	4,56	4,56	4,56	4,56
3,00	5,20	2,81	3,03	3,25	3,46	3,68	3,90	4,11	4,33	4,55	4,76	4,98	5,20	5,20	5,20	5,20
3,25	5,86	3,15	3,38	3,61	3,83	4,06	4,28	4,51	4,73	4,96	5,18	5,41	5,63	5,86	5,86	5,86
3,50	6,55	3,51	3,74	3,98	4,21	4,44	4,68	4,91	5,14	5,38	5,61	5,85	6,08	6,31	6,55	6,55
3,75	7,26	3,87	4,12	4,36	4,60	4,84	5,08	5,33	5,57	5,81	6,05	6,29	6,54	6,78	7,02	7,26
4,00	8,00	4,25	4,50	4,75	5,00	5,25	5,50	5,75	6,00	6,25	6,50	6,75	7,00	7,25	7,50	7,75
4,25	8,76	4,64	4,90	5,15	5,41	5,67	5,93	6,18	6,44	6,70	6,96	7,22	7,47	7,73	7,99	8,25
4,50	9,55	5,04	5,30	5,57	5,83	6,10	6,36	6,63	6,89	7,16	7,42	7,69	7,95	8,22	8,49	8,75
4,75	10,35	5,45	5,72	5,99	6,27	6,54	6,81	7,08	7,36	7,63	7,90	8,17	8,45	8,72	8,99	9,26
5,00	11,18	5,87	6,15	6,43	6,71	6,99	7,27	7,55	7,83	8,11	8,39	8,66	8,94	9,22	9,50	9,78
5,25	12,03	6,30	6,59	6,87	7,16	7,45	7,73	8,02	8,31	8,59	8,88	9,17	9,45	9,74	10,02	10,31
5,50	12,90	6,74	7,04	7,33	7,62	7,92	8,21	8,50	8,79	9,09	9,38	9,67	9,97	10,26	10,55	10,85

a) The anchor spacing and the edge distance shall not be smaller than the minimum anchor spacing s_{min} and the minimum edge distance c_{min} .

Influence of embedment depth

Anchor size	M8	M10	M12	M16	M20
$f_{hef} =$	1,38	1,21	1,04	1,22	1,45

Influence of edge distance ^{a)}

c/d	4	6	8	10	15	20	30	40
$f_c = (d / c)^{0,19}$	0,77	0,71	0,67	0,65	0,60	0,57	0,52	0,50

a) The edge distance shall not be smaller than the minimum edge distance c_{min} .

Combined tension and shear loading

For combined tension and shear loading see section "Anchor Design".

Precalculated values – design resistance values

All data applies to:

- non-cracked concrete C 20/25 – $f_{ck,cube} = 25 \text{ N/mm}^2$
- temperature range I (see service temperature range)
- minimum thickness of base material
- no effects of dense reinforcement

Recommended loads can be calculated by dividing the design resistance by an overall partial safety factor for action $\gamma = 1,4$. The partial safety factors for action depend on the type of loading and shall be taken from national regulations.

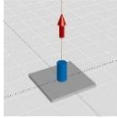
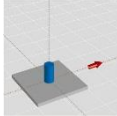

Design resistance: non-cracked- concrete C 20/25

Anchor size		M8x90	M10x110	M12x125	M16x170	M20x205
Embedment depth	h_{ef} [mm]	90	110	125	170	205
Base material thickness	$h = h_{min}$ [mm]	120	150	170	230	270
	Tensile N_{Rd}: single anchor, no edge effects					
	Non-cracked concrete					
	HIS-N [kN]	17,5	30,7	44,7	74,6	74,1
	HIS-RN [kN]	13,9	21,9	31,6	58,8	69,2
	Cracked concrete					
	HIS-N [kN]	16,5	26,6	33,5	53,2	70,4
HIS-RN [kN]	13,9	21,9	31,6	53,2	69,2	
	Shear V_{Rd}: single anchor, no edge effects, without lever arm					
	Non-cracked concrete					
	HIS-N [kN]	10,4	18,4	26,0	39,3	36,7
	HIS-RN [kN]	8,3	12,8	19,2	35,3	41,5
	Cracked concrete					
	HIS-N [kN]	10,4	18,4	26,0	39,3	36,7
HIS-RN [kN]	8,3	12,8	19,2	35,3	41,5	

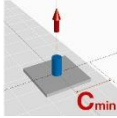
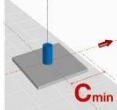

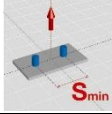

Design resistance: non-cracked- concrete C 20/25

Anchor size		M8x90	M10x110	M12x125	M16x170	M20x205
Embedment depth	h_{ef} [mm]	90	110	125	170	205
Base material thickness	$h = h_{min}$ [mm]	120	150	170	230	270
Edge distance	$c = c_{min}$ [mm]	40	45	55	65	90
	Tensile N_{Rd}: single anchor, min. edge distance ($c = c_{min}$)					
	Non-cracked concrete					
	HIS-N [kN]	13,1	17,5	21,6	33,1	44,9
	HIS-RN [kN]	13,1	17,5	21,6	33,1	44,9
	Cracked concrete					
	HIS-N [kN]	8,4	13,2	17,1	25,9	35,9
HIS-RN [kN]	8,4	13,2	17,1	25,9	35,9	
	Shear V_{Rd}: single anchor, min. edge distance ($c = c_{min}$), without lever arm					
	Non-cracked concrete					
	HIS-N [kN]	4,2	5,5	7,6	10,8	17,2
	HIS-RN [kN]	4,2	5,5	7,6	10,8	17,2
	Cracked concrete					
	HIS-N [kN]	3,0	3,9	5,4	7,7	12,2
HIS-RN [kN]	3,0	3,9	5,4	7,7	12,2	

Design resistance: non-cracked- concrete C 20/25

Anchor size		M8x90	M10x110	M12x125	M16x170	M20x205
Embedment depth	h_{ef} [mm]	90	110	125	170	205
Base material thickness	$h = h_{min}$ [mm]	120	150	170	230	270
Spacing	$s = s_{min}$ [mm]	40	45	55	65	90
Tensile N_{Rd}: double anchor, no edge effects, min. spacing ($s = s_{min}$)						
Non-cracked concrete						
	HIS-N [kN]	15,8	21,3	25,9	40,6	54,3
	HIS-RN [kN]	13,9	21,3	25,9	40,6	54,3
Cracked concrete						
	HIS-N [kN]	10,1	15,4	19,2	30,0	40,4
	HIS-RN [kN]	10,1	15,4	19,2	30,0	40,4
Shear V_{Rd}: double anchor, no edge effects, min. spacing ($s = s_{min}$), without lever arm						
Non-cracked concrete						
	HIS-N [kN]	10,4	18,4	26,0	39,3	36,7
	HIS-RN [kN]	8,3	12,8	19,2	35,3	41,5
Cracked concrete						
	HIS-N [kN]	10,4	18,4	26,0	39,3	36,7
	HIS-RN [kN]	8,3	12,8	19,2	35,3	41,5

Hilti HIT-HY 200 mortar with rebar (as anchor)

Injection mortar system		Benefits
	<p>Hilti HIT-HY 200-A 500 ml foil pack (also available as 330 ml)</p>	<ul style="list-style-type: none"> - SAFEset technology: drilling and borehole cleaning in one step with Hilti hollow drill bit - suitable for cracked and non-cracked concrete C 20/25 to C 50/60 - ETA seismic approval C1 - high loading capacity, excellent handling - HY 200-R version with extended curing time for rebar applications - small edge distance and anchor spacing possible - large diameter applications - in service temperature range up to 120°C short term/72°C long term - manual cleaning for anchor size $\varnothing 8$ to $\varnothing 16$ and embedment depth $h_{ef} \leq 10d$ for non-cracked concrete - embedment depth range: from 60 ... 160 mm for $\varnothing 8$ to 128 ... 640 mm for $\varnothing 32$ - two mortar (A and R) versions available with different curing times and same performance
	<p>Hilti HIT-HY 200-R 500 ml foil pack (also available as 330 ml)</p>	
	<p>Static mixer</p>	
	<p>rebar BSt 500 S</p>	



Concrete



Tensile zone



Seismic
ETA-C1



Small edge
distance
and spacing

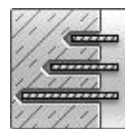

Variable
embedment
depth



Approved
automatic
cleaning while
drilling

SAFEset

Hilti **SAFEset**
technology with
hollow drill bit



European
Technical
Approval



CE
conformity



PROFIS
Anchor design
software

Approvals / certificates

Description	Authority / Laboratory	No. / date of issue
European technical approval ^{a)}	DIBt, Berlin	ETA-11/0493 / 2013-06-20 (Hilti HIT-HY 200-A) ETA-12/0084 / 2013-06-20 (Hilti HIT-HY 200-R)

a) All data given in this section according ETA-11/0493 and ETA-12/0084, issue 2013-06-20.

Basic loading data (for a single anchor)

All data in this section applies to

For details see Simplified design method

- Correct setting (See setting instruction)
- No edge distance and spacing influence
- Steel failure
- Base material thickness, as specified in the table
- One typical embedment depth, as specified in the table
- One anchor material, as specified in the tables
- Concrete C 20/25, $f_{ck,cube} = 25 \text{ N/mm}^2$
- Temperate range I
(min. base material temperature -40°C , max. long term/short term base material temperature: $+24^\circ\text{C}/40^\circ\text{C}$)
- Installation temperature range $+5^\circ\text{C}$ to $+40^\circ\text{C}$

Embedment depth ^{a)} and base material thickness for the basic loading data.

Mean ultimate resistance, characteristic resistance, design resistance, recommended loads.

	Data according ETA-11/0493 and ETA-12/0084, issue 2013-06-20								
Anchor size	Ø8	Ø10	Ø12	Ø14	Ø16	Ø20	Ø25	Ø28	Ø32
Typical embedment depth [mm]	80	90	110	125	145	170	210	270	300
Base material thickness [mm]	110	120	145	165	185	220	275	340	380

a) The allowed range of embedment depth is shown in the setting details. The corresponding load values can be calculated according to the simplified design method.

Mean ultimate resistance: concrete C 20/25 – $f_{ck,cube} = 25 \text{ N/mm}^2$, anchor rebar BSt 500S

	Data according ETA-11/0493 and ETA-12/0084, issue 2013-06-20								
Anchor size	Ø8	Ø10	Ø12	Ø14	Ø16	Ø20	Ø25	Ø28	Ø32
Non cracked concrete									
Tensile $N_{Ru,m}$ BSt 500 S [kN]	29,4	45,0	65,1	87,6	116,1	148,6	204,0	297,4	348,4
Shear $V_{Ru,m}$ BSt 500 S [kN]	14,7	23,1	32,6	44,1	57,8	90,3	141,8	177,5	232,1
Cracked concrete									
Tensile $N_{Ru,m}$ BSt 500 S [kN]	-	18,8	38,5	51,1	67,7	99,3	145,4	212,0	248,3
Shear $V_{Ru,m}$ BSt 500 S [kN]	-	23,1	32,6	44,1	57,8	90,3	141,8	177,5	232,1

Characteristic resistance: concrete C 20/25 – $f_{ck,cube} = 25 \text{ N/mm}^2$, anchor rebar BSt 500 S

	Data according ETA-11/0493 and ETA-12/0084, issue 2013-06-20								
Anchor size	Ø8	Ø10	Ø12	Ø14	Ø16	Ø20	Ø25	Ø28	Ø32
Non cracked concrete									
Tensile N_{Rk} BSt 500 S [kN]	24,1	33,9	49,8	66,0	87,5	111,9	153,7	224,0	262,4
Shear V_{Rk} BSt 500 S [kN]	14,0	22,0	31,0	42,0	55,0	86,0	135,0	169,0	221,0
Cracked concrete									
Tensile N_{Rk} BSt 500 S [kN]	-	14,1	29,0	38,5	51,0	74,8	109,6	159,7	187,1
Shear V_{Rk} BSt 500 S [kN]	-	22,0	31,0	42,0	55,0	86,0	135,0	169,0	221,0

Design resistance: concrete C 20/25 – $f_{ck,cube} = 25 \text{ N/mm}^2$, anchor rebar BSt 500 S

	Data according ETA-11/0493 and ETA-12/0084, issue 2013-06-20								
Anchor size	Ø8	Ø10	Ø12	Ø14	Ø16	Ø20	Ø25	Ø28	Ø32
Non cracked concrete									
Tensile N_{Rd} BSt 500 S [kN]	16,1	22,6	33,2	44,0	58,3	74,6	102,5	149,4	174,9
Shear V_{Rd} BSt 500 S [kN]	9,3	14,7	20,7	28,0	36,7	57,3	90,0	112,7	147,3
Cracked concrete									
Tensile N_{Rd} BSt 500 S [kN]	-	9,4	19,4	25,7	34,0	49,8	73,0	106,5	124,7
Shear V_{Rd} BSt 500 S [kN]	-	14,7	20,7	28,0	36,7	57,3	90,0	112,7	147,3

Recommended loads ^{a)}: concrete C 20/25 – $f_{ck,cube} = 25 \text{ N/mm}^2$, anchor rebar BSt 500 S

			Data according ETA-11/0493 and ETA-12/0084, issue 2013-06-20								
Anchor size			Ø8	Ø10	Ø12	Ø14	Ø16	Ø20	Ø25	Ø28	Ø32
Non cracked concrete											
Tensile N_{rec}	BSt 500 S	[kN]	11,5	16,2	23,7	31,4	41,6	53,3	73,2	106,7	125,0
Shear V_{rec}	BSt 500 S	[kN]	6,7	10,5	14,8	20,0	26,2	41,0	64,3	80,5	105,2
Cracked concrete											
Tensile N_{rec}	BSt 500 S	[kN]	-	6,7	13,8	18,3	24,3	35,6	52,2	76,1	89,1
Shear V_{rec}	BSt 500 S	[kN]	-	10,5	14,8	20,0	26,2	41,0	64,3	80,5	105,2

a) With overall partial safety factor for action $\gamma = 1,4$. The partial safety factors for action depend on the type of loading and shall be taken from national regulations.

Service temperature range

Hilti HIT-HY 200 injection mortar may be applied in the temperature ranges given below. An elevated base material temperature may lead to a reduction of the design bond resistance.

Temperature range	Base material temperature	Maximum long term base material temperature	Maximum short term base material temperature
Temperature range I	-40 °C to +40 °C	+24 °C	+40 °C
Temperature range II	-40 °C to +80 °C	+50 °C	+80 °C
Temperature range III	-40 °C to +120 °C	+72 °C	+120 °C

Max short term base material temperature

Short-term elevated base material temperatures are those that occur over brief intervals, e.g. as a result of diurnal cycling.

Max long term base material temperature

Long-term elevated base material temperatures are roughly constant over significant periods of time.

Materials

Mechanical properties of rebar BSt 500S

			Data according ETA-11/0493 and ETA-12/0084, issue 2013-06-20								
Anchor size			Ø8	Ø10	Ø12	Ø14	Ø16	Ø20	Ø25	Ø28	Ø32
Nominal tensile strength f_{uk}	BSt 500 S	[N/mm ²]	550	550	550	550	550	550	550	550	550
Yield strength f_{yk}	BSt 500 S	[N/mm ²]	500	500	500	500	500	500	500	500	500
Stressed cross-section A_s	BSt 500 S	[mm ²]	50,3	78,5	113,1	153,9	201,1	314,2	490,9	615,8	804,2
Moment of resistance W	BSt 500 S	[mm ³]	50,3	98,2	169,6	269,4	402,1	785,4	1534	2155	3217

Material quality

Part	Material
rebar BSt 500 S	Geometry and mechanical properties according to DIN 488-2:1986 or E DIN 488-2:2006

Setting

Installation equipment

Anchor size	Ø8	Ø10	Ø12	Ø14	Ø16	Ø20	Ø25	Ø28	Ø32
Rotary hammer	TE 2 – TE 16					TE 40 – TE 70			
Other tools	compressed air gun or blow out pump, set of cleaning brushes, dispenser								

Setting instruction

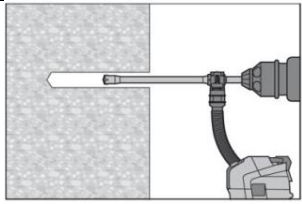
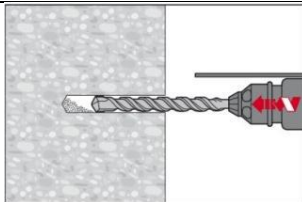
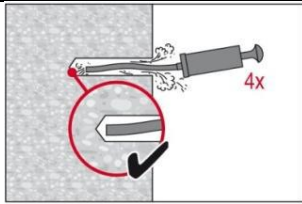
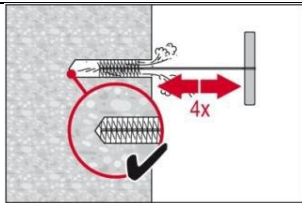
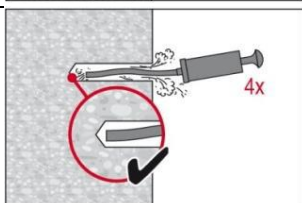
Bore hole drilling	
	Drill hole to the required embedment depth with an appropriately sized Hilti TE-CD or TE-YD hollow drill bit with Hilti vacuum attachment. This drilling method properly cleans the borehole and removes dust while drilling. After drilling is complete, proceed to the "injection preparation" step in the instructions for use.
	Drill Hole to the required embedment depth with a hammer drill set in rotation-hammer mode using an appropriately sized carbide drill bit.
Bore hole cleaning Just before setting an anchor, the bore hole must be free of dust and debris.	
a) Manual Cleaning (MC) non-cracked concrete only for bore hole diameters $d_0 \leq 20\text{mm}$ and bore hole depth $h_0 \leq 10d$	
	The Hilti manual pump may be used for blowing out bore holes up to diameters $d_0 \leq 20\text{ mm}$ and embedment depths up to $h_{ef} \leq 10d$. Blow out at least 4 times from the back of the bore hole until return air stream is free of noticeable dust
	Brush 4 times with the specified brush size by inserting the steel brush Hilti HIT-RB to the back of the hole (if needed with extension) in a twisting motion and removing it. The brush must produce natural resistance as it enters the bore hole -- if not the brush is too small and must be replaced with the proper brush diameter.
	Blow out again with manual pump at least 4 times until return air stream is free of noticeable dust.

b) Compressed air cleaning (CAC)

for all bore hole diameters d_0 and all bore hole depth h_0

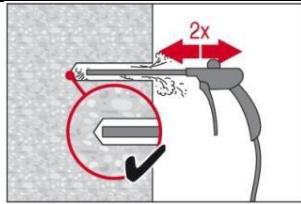

Blow 2 times from the back of the hole (if needed with nozzle extension) over the hole length with oil-free compressed air (min. 6 bar at 6 m³/h) until return air stream is free of noticeable dust. Bore hole diameter ≥ 32 mm the compressor must supply a minimum air flow of 140 m³/hour.

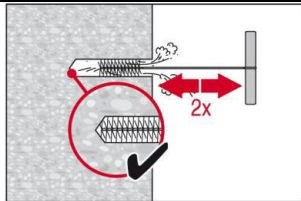

Brush 2 times with the specified brush size by inserting the steel brush Hilti HIT-RB to the back of the hole (if needed with extension) in a twisting motion and removing it. The brush must produce natural resistance as it enters the bore hole -- if not the brush is too small and must be replaced with the proper brush diameter.

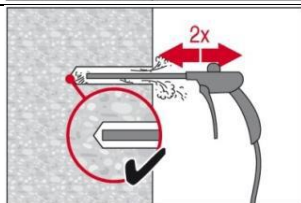

Blow again with compressed air 2 times until return air stream is free of noticeable dust.

Injection preparation

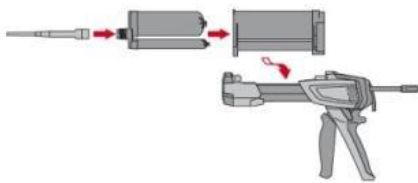

Tightly attach new Hilti mixing nozzle HIT-RE-M to foil pack manifold (snug fit). Do not modify the mixing nozzle. Observe the instruction for use of the dispenser. Check foil pack holder for proper function. Do not use damaged foil packs / holders. Swing foil pack holder with foil pack into HIT-dispenser.

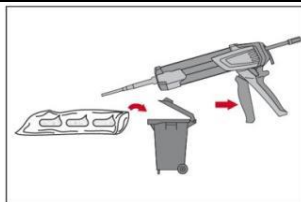

Discard initial adhesive. The foil pack opens automatically as dispensing is initiated. Depending on the size of the foil pack an initial amount of adhesive has to be discarded.
Discard quantities are:
2 strokes for 330 ml foil pack,
3 strokes for 500 ml foil pack,
4 strokes for 500 ml foil pack $\leq 5^\circ\text{C}$.

Inject adhesive from the back of the borehole without forming air voids

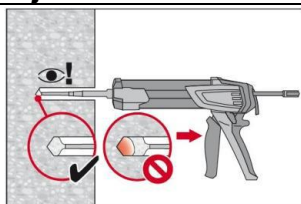

Inject the adhesive starting at the back of the hole, slowly withdrawing the mixer with each trigger pull. Fill holes approximately 2/3 full, or as required to ensure that the annular gap between the anchor and the concrete is completely filled with adhesive along the embedment length.

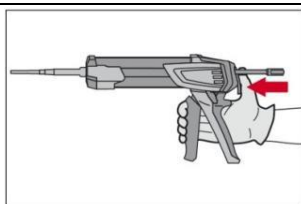

After injection is completed, depressurize the dispenser by pressing the release trigger. This will prevent further adhesive discharge from the mixer.

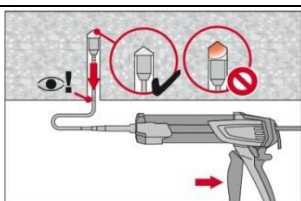

Overhead installation and/or installation with embedment depth $h_{ef} > 250\text{mm}$. For overhead installation the injection is only possible with the aid of extensions and piston plugs. Assemble HIT-RE-M mixer, extension(s) and appropriately sized piston plug. Insert piston plug to back of the hole and inject adhesive. During injection the piston plug will be naturally extruded out of the bore hole by the adhesive pressure.

Setting the element

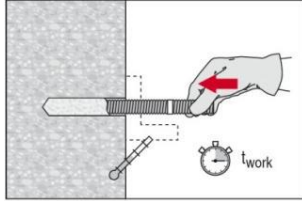

Before use, verify that the element is dry and free of oil and other contaminants.
Mark and set element to the required embedment depth until working time t_{work} has elapsed.

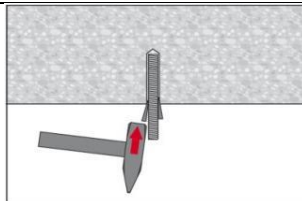

For overhead installation use piston plugs and fix embedded parts with e.g. wedges

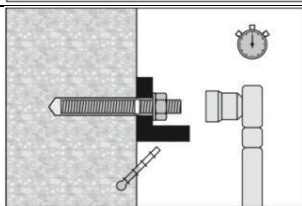

Loading the anchor:
After required curing time t_{cure} the anchor can be loaded.
The applied installation torque shall not exceed T_{max} .

For detailed information on installation see instruction for use given with the package of the product.

Working time, curing time

Temperature of the base material	Hilti HIT-HY 200-R	
	Working time in which anchor can be inserted and adjusted t_{work}	Curing time before anchor can be loaded t_{cure}
-10 °C to -5 °C	3 hour	20 hour
-4 °C to 0 °C	2 hour	8 hour
1 °C to 5 °C	1 hour	4 hour
6 °C to 10 °C	40 min	2,5 hour
11 °C to 20 °C	15 min	1,5 hour
21 °C to 30 °C	9 min	1 hour
31 °C to 40 °C	6 min	1 hour

Temperature of the base material	Hilti HIT-HY 200-A	
	Working time in which anchor can be inserted and adjusted t_{work}	Curing time before anchor can be loaded t_{cure}
-10 °C to -5 °C	1,5 hour	7 hour
-4 °C to 0 °C	50 min	4 hour
1 °C to 5 °C	25 min	2 hour
6 °C to 10 °C	15 min	75 min
11 °C to 20 °C	7 min	45 min
21 °C to 30 °C	4 min	30 min
31 °C to 40 °C	3 min	30 min

Setting details

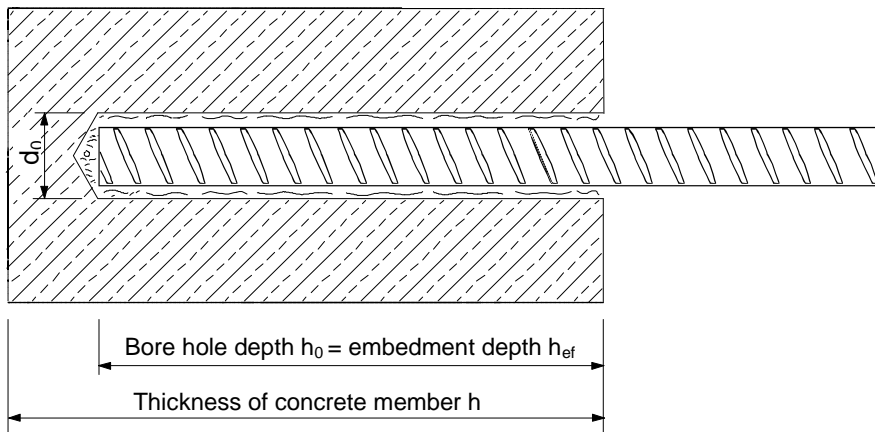

Setting details

			Data according ETA-11/0493 and ETA-12/0084, issue 2013-06-20								
Anchor size			Ø8	Ø10	Ø12	Ø14	Ø16	Ø20	Ø25	Ø28	Ø32
Nominal diameter of drill bit	d_0	[mm]	12 (10) ^{a)}	14 (12) ^{a)}	16 (14) ^{a)}	18	20	25	32	35	40
Effective anchorage and drill hole depth range ^{b)}	$h_{ef,min}$	[mm]	60	60	70	75	80	90	100	112	128
	$h_{ef,max}$	[mm]	160	200	240	280	320	400	500	560	640
Minimum base material thickness	h_{min}	[mm]	$h_{ef} + 30$ mm			$h_{ef} + 2 d_0$					
Minimum spacing	s_{min}	[mm]	40	50	60	70	80	100	125	140	160
Minimum edge distance	c_{min}	[mm]	40	50	60	70	80	100	125	140	160
Critical spacing for splitting failure	$s_{cr,sp}$		$2 c_{cr,sp}$								
Critical edge distance for splitting failure ^{c)}	$c_{cr,sp}$	[mm]	$1,0 \cdot h_{ef}$ for $h / h_{ef} \geq 2,0$								
			$4,6 h_{ef} - 1,8 h$ for $2,0 > h / h_{ef} > 1,3$								
			$2,26 h_{ef}$ for $h / h_{ef} \leq 1,3$								
Critical spacing for concrete cone failure	$s_{cr,N}$		$2 c_{cr,N}$								
Critical edge distance for concrete cone failure ^{d)}	$c_{cr,N}$		$1,5 h_{ef}$								

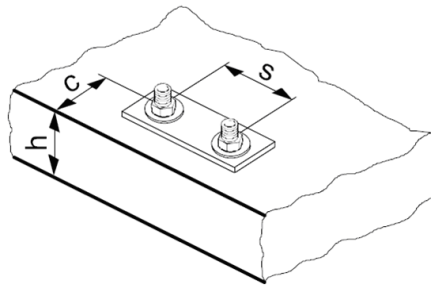

For spacing (edge distance) smaller than critical spacing (critical edge distance) the design loads have to be reduced.

- a) both given values for drill bit diameter can be used
- b) $h_{ef,min} \leq h_{ef} \leq h_{ef,max}$ (h_{ef} : embedment depth)
- c) h : base material thickness ($h \geq h_{min}$)
- d) The critical edge distance for concrete cone failure depends on the embedment depth h_{ef} and the design bond resistance. The simplified formula given in this table is on the save side.

Simplified design method

Simplified version of the design method according ETAG 001, TR 029. Design resistance according data given in ETA-11/0493 issued 2013-06-20 for HIT-HY 200-A and ETA-12/0084 issued 2013-06-20 for HIT-HY 200-R. Both mortars possess identical technical load performance.

- Influence of concrete strength
- Influence of edge distance
- Influence of spacing
- Valid for a group of two anchors. (The method may also be applied for anchor groups with more than two anchors or more than one edge distance. The influencing factors must then be considered for each edge distance and spacing. The simplified calculated design loads take a conservative approach: They will be lower than the exact values according to ETAG 001, TR 029. For an optimized design, anchor calculation can be performed using PROFIS anchor design software.

The design method is based on the following simplification:

- No different loads are acting on individual anchors (no eccentricity)

The values are valid for one anchor.

For more complex fastening applications please use the anchor design software PROFIS Anchor.

Tension loading

The design tensile resistance is the lower value of

- Steel resistance: $N_{Rd,s}$
- Combined pull-out and concrete cone resistance: $N_{Rd,p} = N_{Rd,p}^0 \cdot f_{B,p} \cdot f_{1,N} \cdot f_{2,N} \cdot f_{3,N} \cdot f_{h,p} \cdot f_{re,N}$
- Concrete cone resistance: $N_{Rd,c} = N_{Rd,c}^0 \cdot f_B \cdot f_{1,N} \cdot f_{2,N} \cdot f_{3,N} \cdot f_{h,N} \cdot f_{re,N}$
- Concrete splitting resistance (only non-cracked concrete): $N_{Rd,sp} = N_{Rd,c}^0 \cdot f_B \cdot f_{1,sp} \cdot f_{2,sp} \cdot f_{3,sp} \cdot f_{h,N} \cdot f_{re,N}$

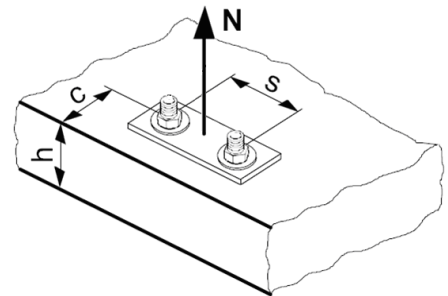

Basic design tensile resistance

Design steel resistance $N_{Rd,s}$

			Data according ETA-11/0493 and ETA-12/0084, issue 2013-06-20								
Anchor size			Ø8	Ø10	Ø12	Ø14	Ø16	Ø20	Ø25	Ø28	Ø32
$N_{Rd,s}$	BSt 500 S	[kN]	20,0	30,7	44,3	60,7	79,3	123,6	192,9	242,1	315,7

Design combined pull-out and concrete cone resistance

$$N_{Rd,p} = N_{Rd,p}^0 \cdot f_{B,p} \cdot f_{1,N} \cdot f_{2,N} \cdot f_{3,N} \cdot f_{h,p} \cdot f_{re,N}$$

Data according ETA-11/0493 and ETA-12/0084, issue 2013-06-20										
Anchor size	Ø8	Ø10	Ø12	Ø14	Ø16	Ø20	Ø25	Ø28	Ø32	
Typical embedment depth $h_{ef,typ}$ [mm]	80	90	110	125	145	170	210	270	300	
Non cracked concrete										
$N_{Rd,p}^0$ Temperature range I [kN]	16,1	22,6	33,2	44,0	58,3	85,5	131,9	190,0	241,3	
$N_{Rd,p}^0$ Temperature range II [kN]	13,4	18,8	27,6	36,7	48,6	71,2	110,0	158,3	201,1	
$N_{Rd,p}^0$ Temperature range III [kN]	11,4	16,0	23,5	31,2	41,3	60,5	93,5	134,6	170,9	
Cracked concrete										
$N_{Rd,p}^0$ Temperature range I [kN]	-	9,4	19,4	25,7	34,0	49,8	77,0	110,8	140,7	
$N_{Rd,p}^0$ Temperature range II [kN]	-	7,5	15,2	20,2	26,7	39,2	60,5	87,1	110,6	
$N_{Rd,p}^0$ Temperature range III [kN]	-	6,6	13,8	18,3	24,3	35,6	55,0	79,2	100,5	

$$\text{Design concrete cone resistance } N_{Rd,c} = N_{Rd,c}^0 \cdot f_B \cdot f_{1,N} \cdot f_{2,N} \cdot f_{3,N} \cdot f_{h,N} \cdot f_{re,N}$$

$$\text{Design splitting resistance } N_{Rd,sp} = N_{Rd,c}^0 \cdot f_B \cdot f_{1,sp} \cdot f_{2,sp} \cdot f_{3,sp} \cdot f_{h,N} \cdot f_{re,N}$$

Data according ETA-11/0493 and ETA-12/0084, issue 2013-06-20										
Anchor size	Ø8	Ø10	Ø12	Ø14	Ø16	Ø20	Ø25	Ø28	Ø32	
$N_{Rd,c}^0$ Non cracked concrete [kN]	24,1	28,7	38,8	47,1	58,8	74,6	102,5	149,4	174,9	
$N_{Rd,c}^0$ Cracked concrete [kN]	-	20,5	27,7	33,5	41,9	53,2	73,0	106,5	124,7	

a) Splitting resistance must only be considered for non-cracked concrete

Influencing factors

Influence of concrete strength on combined pull-out and concrete cone resistance

Concrete strength designation (ENV 206)	C 20/25	C 25/30	C 30/37	C 35/45	C 40/50	C 45/55	C 50/60
$f_{B,p} = (f_{ck,cube}/25N/mm^2)^{0,1}$ a)	1						

a) $f_{ck,cube}$ = concrete compressive strength, measured on cubes with 150 mm side length

Influence of embedment depth on combined pull-out and concrete cone resistance

$$f_{h,p} = h_{ef}/h_{ef,typ}$$

Influence of concrete strength on concrete cone resistance

Concrete strength designation (ENV 206)	C 20/25	C 25/30	C 30/37	C 35/45	C 40/50	C 45/55	C 50/60
$f_B = (f_{ck,cube}/25N/mm^2)^{1/2}$ a)	1	1,1	1,22	1,34	1,41	1,48	1,55

a) $f_{ck,cube}$ = concrete compressive strength, measured on cubes with 150 mm side length

Influence of edge distance ^{a)}

$c/c_{cr,N}$	0,1	0,2	0,3	0,4	0,5	0,6	0,7	0,8	0,9	1
$c/c_{cr,sp}$										
$f_{1,N} = 0,7 + 0,3 \cdot c/c_{cr,N}$	0,73	0,76	0,79	0,82	0,85	0,88	0,91	0,94	0,97	1
$f_{1,sp} = 0,7 + 0,3 \cdot c/c_{cr,sp}$										
$f_{2,N} = 0,5 \cdot (1 + c/c_{cr,N})$	0,55	0,60	0,65	0,70	0,75	0,80	0,85	0,90	0,95	1
$f_{2,sp} = 0,5 \cdot (1 + c/c_{cr,sp})$										

a) The edge distance shall not be smaller than the minimum edge distance c_{min} given in the table with the setting details. These influencing factors must be considered for every edge distance smaller than the critical edge distance.

Influence of anchor spacing ^{a)}

$s/s_{cr,N}$	0,1	0,2	0,3	0,4	0,5	0,6	0,7	0,8	0,9	1
$s/s_{cr,sp}$										
$f_{3,N} = 0,5 \cdot (1 + s/s_{cr,N})$	0,55	0,60	0,65	0,70	0,75	0,80	0,85	0,90	0,95	1
$f_{3,sp} = 0,5 \cdot (1 + s/s_{cr,sp})$										

a) The anchor spacing shall not be smaller than the minimum anchor spacing s_{min} given in the table with the setting details. This influencing factor must be considered for every anchor spacing.

Influence of embedment depth on concrete cone resistance

$$f_{h,N} = (h_{ef}/h_{ef,typ})^{1,5}$$

Influence of reinforcement

h_{ef} [mm]	60	70	80	90	≥ 100
$f_{re,N} = 0,5 + h_{ef}/200mm \leq 1$	0,8 ^{a)}	0,85 ^{a)}	0,9 ^{a)}	0,95 ^{a)}	1

a) This factor applies only for dense reinforcement. If in the area of anchorage there is reinforcement with a spacing ≥ 150 mm (any diameter) or with a diameter ≤ 10 mm and a spacing ≥ 100 mm, then a factor $f_{re} = 1$ may be applied.

Shear loading

The design shear resistance is the lower value of

- Steel resistance: $V_{Rd,s}$
- Concrete pryout resistance: $V_{Rd,cp} = k \cdot \text{lower value of } N_{Rd,p} \text{ and } N_{Rd,c}$
- Concrete edge resistance: $V_{Rd,c} = V_{Rd,c}^0 \cdot f_B \cdot f_h \cdot f_4 \cdot f_{hef} \cdot f_c$

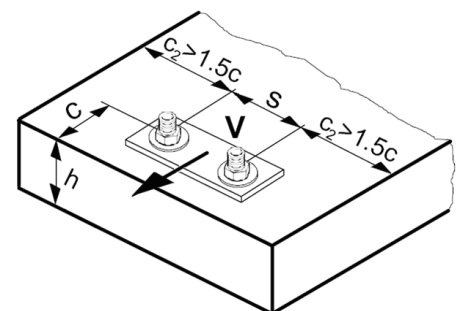

Basic design shear resistance

Design steel resistance $V_{Rd,s}$

Data according ETA-11/0493 and ETA-12/0084, issue 2013-06-20											
Anchor size		Ø8	Ø10	Ø12	Ø14	Ø16	Ø20	Ø25	Ø28	Ø32	
$V_{Rd,s}$	BSt 500 S	[kN]	9,3	14,7	20,7	28,0	36,7	57,3	90,0	112,7	147,3

Design concrete pryout resistance $V_{Rd,cp}$ = lower value^{a)} of $k \cdot N_{Rd,p}$ and $k \cdot N_{Rd,c}$

$$k = 2$$

- a) $N_{Rd,p}$: Design combined pull-out and concrete cone resistance
 $N_{Rd,c}$: Design concrete cone resistance

Design concrete edge resistance $V_{Rd,c} = V_{Rd,c}^0 \cdot f_B \cdot f_\beta \cdot f_h \cdot f_4 \cdot f_{hef} \cdot f_c$

		Data according ETA-11/0493 and ETA-12/0084, issue 2013-06-20								
Anchor size		Ø8	Ø10	Ø12	Ø14	Ø16	Ø20	Ø25	Ø28	Ø32
Non-cracked concrete										
$V_{Rd,c}^0$	[kN]	5,9	8,6	11,6	15,0	18,7	27,0	39,2	47,3	59,0
Cracked concrete										
$V_{Rd,c}^0$	[kN]	-	6,1	8,2	10,6	13,2	19,2	27,7	33,5	41,8

Influencing factors

Influence of concrete strength

Concrete strength designation (ENV 206)	C 20/25	C 25/30	C 30/37	C 35/45	C 40/50	C 45/55	C 50/60
$f_B = (f_{ck,cube}/25N/mm^2)^{1/2}$ a)	1	1,1	1,22	1,34	1,41	1,48	1,55

- a) $f_{ck,cube}$ = concrete compressive strength, measured on cubes with 150 mm side length

Influence of angle between load applied and the direction perpendicular to the free edge

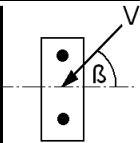
Angle β	0°	10°	20°	30°	40°	50°	60°	70°	80°	≥ 90°
$f_\beta = \sqrt{\frac{1}{(\cos \alpha_V)^2 + \left(\frac{\sin \alpha_V}{2,5}\right)^2}}$ 	1	1,01	1,05	1,13	1,24	1,40	1,64	1,97	2,32	2,50

Influence of base material thickness

h/c	0,15	0,3	0,45	0,6	0,75	0,9	1,05	1,2	1,35	≥ 1,5
$f_h = \{h/(1,5 \cdot c)\}^{1/2} \leq 1$	0,32	0,45	0,55	0,63	0,71	0,77	0,84	0,89	0,95	1,00

Influence of anchor spacing and edge distance ^{a)} for concrete edge resistance: f_4

$$f_4 = (c/h_{ef})^{1,5} \cdot (1 + s / [3 \cdot c]) \cdot 0,5$$

c/h _{ef}	Single anchor	Group of two anchors s/h _{ef}														
		0,75	1,50	2,25	3,00	3,75	4,50	5,25	6,00	6,75	7,50	8,25	9,00	9,75	10,50	11,25
0,50	0,35	0,27	0,35	0,35	0,35	0,35	0,35	0,35	0,35	0,35	0,35	0,35	0,35	0,35	0,35	0,35
0,75	0,65	0,43	0,54	0,65	0,65	0,65	0,65	0,65	0,65	0,65	0,65	0,65	0,65	0,65	0,65	0,65
1,00	1,00	0,63	0,75	0,88	1,00	1,00	1,00	1,00	1,00	1,00	1,00	1,00	1,00	1,00	1,00	1,00
1,25	1,40	0,84	0,98	1,12	1,26	1,40	1,40	1,40	1,40	1,40	1,40	1,40	1,40	1,40	1,40	1,40
1,50	1,84	1,07	1,22	1,38	1,53	1,68	1,84	1,84	1,84	1,84	1,84	1,84	1,84	1,84	1,84	1,84
1,75	2,32	1,32	1,49	1,65	1,82	1,98	2,15	2,32	2,32	2,32	2,32	2,32	2,32	2,32	2,32	2,32
2,00	2,83	1,59	1,77	1,94	2,12	2,30	2,47	2,65	2,83	2,83	2,83	2,83	2,83	2,83	2,83	2,83
2,25	3,38	1,88	2,06	2,25	2,44	2,63	2,81	3,00	3,19	3,38	3,38	3,38	3,38	3,38	3,38	3,38
2,50	3,95	2,17	2,37	2,57	2,77	2,96	3,16	3,36	3,56	3,76	3,95	3,95	3,95	3,95	3,95	3,95
2,75	4,56	2,49	2,69	2,90	3,11	3,32	3,52	3,73	3,94	4,15	4,35	4,56	4,56	4,56	4,56	4,56
3,00	5,20	2,81	3,03	3,25	3,46	3,68	3,90	4,11	4,33	4,55	4,76	4,98	5,20	5,20	5,20	5,20
3,25	5,86	3,15	3,38	3,61	3,83	4,06	4,28	4,51	4,73	4,96	5,18	5,41	5,63	5,86	5,86	5,86
3,50	6,55	3,51	3,74	3,98	4,21	4,44	4,68	4,91	5,14	5,38	5,61	5,85	6,08	6,31	6,55	6,55
3,75	7,26	3,87	4,12	4,36	4,60	4,84	5,08	5,33	5,57	5,81	6,05	6,29	6,54	6,78	7,02	7,26
4,00	8,00	4,25	4,50	4,75	5,00	5,25	5,50	5,75	6,00	6,25	6,50	6,75	7,00	7,25	7,50	7,75
4,25	8,76	4,64	4,90	5,15	5,41	5,67	5,93	6,18	6,44	6,70	6,96	7,22	7,47	7,73	7,99	8,25
4,50	9,55	5,04	5,30	5,57	5,83	6,10	6,36	6,63	6,89	7,16	7,42	7,69	7,95	8,22	8,49	8,75
4,75	10,35	5,45	5,72	5,99	6,27	6,54	6,81	7,08	7,36	7,63	7,90	8,17	8,45	8,72	8,99	9,26
5,00	11,18	5,87	6,15	6,43	6,71	6,99	7,27	7,55	7,83	8,11	8,39	8,66	8,94	9,22	9,50	9,78
5,25	12,03	6,30	6,59	6,87	7,16	7,45	7,73	8,02	8,31	8,59	8,88	9,17	9,45	9,74	10,02	10,31
5,50	12,90	6,74	7,04	7,33	7,62	7,92	8,21	8,50	8,79	9,09	9,38	9,67	9,97	10,26	10,55	10,85

a) The anchor spacing and the edge distance shall not be smaller than the minimum anchor spacing s_{min} and the minimum edge distance c_{min} .

Influence of embedment depth

h _{ef} /d	4	4,5	5	6	7	8	9	10	11
f _{hef} = 0,05 · (h _{ef} / d) ^{1,68}	0,51	0,63	0,75	1,01	1,31	1,64	2,00	2,39	2,81
h _{ef} /d	12	13	14	15	16	17	18	19	20
f _{hef} = 0,05 · (h _{ef} / d) ^{1,68}	3,25	3,72	4,21	4,73	5,27	5,84	6,42	7,04	7,67

Influence of edge distance ^{a)}

c/d	4	6	8	10	15	20	30	40
f _c = (d / c) ^{0,19}	0,77	0,71	0,67	0,65	0,60	0,57	0,52	0,50

a) The edge distance shall not be smaller than the minimum edge distance c_{min} .

Combined tension and shear loading

For combined tension and shear loading see section "Anchor Design".

Precalculated values

Recommended loads can be calculated by dividing the design resistance by an overall partial safety factor for action $\gamma = 1,4$. The partial safety factors for action depend on the type of loading and shall be taken from national regulations.

Design resistance: concrete C 20/25 – $f_{ck,cube} = 25 \text{ N/mm}^2$, Temperature range I

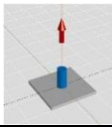
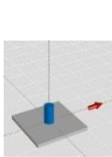
		Data according ETA-11/0493 and ETA-12/0084, issue 2013-06-20									
Anchor size		Ø8	Ø10	Ø12	Ø14	Ø16	Ø20	Ø25	Ø28	Ø32	
Embedment depth $h_{ef,1} =$ [mm]		60	60	72	84	96	120	150	168	192	
Base material thickness $h_{min} =$ [mm]		90	90	104	120	136	170	214	238	272	
	Tensile N_{Rd}: single anchor, no edge effects										
	Non cracked concrete										
	BSt 500 S [kN]	12,1	15,1	20,6	25,9	31,7	44,3	61,8	73,3	89,6	
	Cracked concrete										
	BSt 500 S [kN]	-	6,3	12,7	17,2	22,5	31,5	44,1	52,3	63,9	
	Shear V_{Rd}: single anchor, no edge effects, without lever arm										
Non cracked concrete											
BSt 500 S [kN]	9,3	14,7	20,7	28,0	36,7	57,3	90,0	112,7	147,3		
Cracked concrete											
BSt 500 S [kN]	-	12,6	20,7	28,0	36,7	57,3	88,2	104,5	127,7		

Design resistance: concrete C 20/25 – $f_{ck,cube} = 25 \text{ N/mm}^2$, Temperature range I

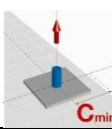
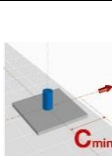
		Data according ETA-11/0493 and ETA-12/0084, issue 2013-06-20									
Anchor size		Ø8	Ø10	Ø12	Ø14	Ø16	Ø20	Ø25	Ø28	Ø32	
Embedment depth $h_{ef,1} =$ [mm]		60	60	72	84	96	120	150	168	192	
Base material thickness $h_{min} =$ [mm]		90	90	104	120	136	170	214	238	272	
Edge distance $c = c_{min} =$ [mm]		40	50	60	80	100	120	135	150	150	
	Tensile N_{Rd}: single anchor, min. edge distance ($c = c_{min}$)										
	Non cracked concrete										
	BSt 500 S [kN]	7,3	9,4	12,0	16,0	20,4	27,9	37,2	43,7	50,4	
	Cracked concrete										
	BSt 500 S [kN]	-	4,2	8,5	12,6	17,3	23,7	31,0	36,6	41,6	
	Shear V_{Rd}: single anchor, min. edge distance ($c = c_{min}$), without lever arm										
Non cracked concrete											
BSt 500 S [kN]	3,5	4,9	6,7	10,3	13,7	19,3	25,2	30,2	32,0		
Cracked concrete											
BSt 500 S [kN]	-	3,5	4,7	7,3	9,7	13,6	17,8	21,4	22,7		

Design resistance: concrete C 20/25 – $f_{ck,cube} = 25 \text{ N/mm}^2$, Temperature range I
(load values are valid for single anchor)

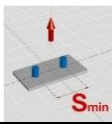
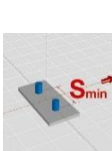
		Data according ETA-11/0493 and ETA-12/0084, issue 2013-06-20									
Anchor size		Ø8	Ø10	Ø12	Ø14	Ø16	Ø20	Ø25	Ø28	Ø32	
Embedment depth $h_{ef,1} =$ [mm]		60	60	72	84	96	120	150	168	192	
Base material thickness $h_{min} =$ [mm]		90	90	104	120	136	170	214	238	272	
Spacing $s = s_{min} =$ [mm]		40	50	60	80	100	120	135	150	150	
	Tensile N_{Rd}: double anchor, no edge effects, min. spacing ($s = s_{min}$)										
	Non cracked concrete										
	BSt 500 S [kN]	7,9	9,5	12,4	16,0	19,9	27,5	37,8	44,6	53,3	
	Cracked concrete										
	BSt 500 S [kN]	-	4,5	8,4	11,6	15,2	21,0	28,7	33,9	40,2	
	Shear V_{Rd}: double anchor, no edge effects, min. spacing ($s = s_{min}$), without lever arm										
Non cracked concrete											
BSt 500 S [kN]	9,3	14,7	20,7	28,0	36,7	57,3	80,4	95,1	112,9		
Cracked concrete											
BSt 500 S [kN]	-	8,0	16,2	22,7	30,3	42,1	57,3	67,8	80,5		

Design resistance: concrete C 20/25 – $f_{ck,cube} = 25 \text{ N/mm}^2$, Temperature range I

		Data according ETA-11/0493 and ETA-12/0084, issue 2013-06-20								
Anchor size		Ø8	Ø10	Ø12	Ø14	Ø16	Ø20	Ø25	Ø28	Ø32
Embedment depth $h_{ef,typ} =$ [mm]		80	90	110	125	145	170	210	270	300
Base material thickness $h_{min} =$ [mm]		110	120	142	161	185	220	274	340	380
	Tensile N_{Rd}: single anchor, no edge effects									
	Non cracked concrete									
	BSt 500 S [kN]	16,1	22,6	33,2	44,0	58,3	74,6	102,5	149,4	174,9
	Cracked concrete									
	BSt 500 S [kN]	-	9,4	19,4	25,7	34,0	49,8	73,0	106,5	124,7
	Shear V_{Rd}: single anchor, no edge effects, without lever arm									
Non cracked concrete										
BSt 500 S [kN]	9,3	14,7	20,7	28,0	36,7	57,3	90,0	112,7	147,3	
Cracked concrete										
BSt 500 S [kN]	-	14,7	20,7	28,0	36,7	57,3	90,0	112,7	147,3	

Design resistance: concrete C 20/25 – $f_{ck,cube} = 25 \text{ N/mm}^2$, Temperature range I

		Data according ETA-11/0493 and ETA-12/0084, issue 2013-06-20								
Anchor size		Ø8	Ø10	Ø12	Ø14	Ø16	Ø20	Ø25	Ø28	Ø32
Embedment depth $h_{ef,typ} =$ [mm]		80	90	110	125	145	170	210	270	300
Base material thickness $h_{min} =$ [mm]		110	120	142	161	185	220	274	340	380
Edge distance $c = c_{min} =$ [mm]		40	50	60	80	100	120	135	150	150
	Tensile N_{Rd}: single anchor, min. edge distance ($c = c_{min}$)									
	Non cracked concrete									
	BSt 500 S [kN]	9,2	12,9	18,6	23,7	30,4	38,9	51,7	72,0	81,9
	Cracked concrete									
	BSt 500 S [kN]	-	5,4	11,1	15,6	21,6	31,0	43,2	59,2	66,5
	Shear V_{Rd}: single anchor, min. edge distance ($c = c_{min}$), without lever arm									
Non cracked concrete										
BSt 500 S [kN]	3,7	5,3	7,3	11,2	15,8	21,5	27,5	34,3	36,5	
Cracked concrete										
BSt 500 S [kN]	-	3,8	5,2	7,9	11,2	15,2	19,5	24,3	25,8	

Design resistance: concrete C 20/25 – $f_{ck,cube} = 25 \text{ N/mm}^2$, Temperature range I
(load values are valid for single anchor)

		Data according ETA-11/0493 and ETA-12/0084, issue 2013-06-20								
Anchor size		Ø8	Ø10	Ø12	Ø14	Ø16	Ø20	Ø25	Ø28	Ø32
Embedment depth $h_{ef,typ} =$ [mm]		80	90	110	125	145	170	210	270	300
Base material thickness $h_{min} =$ [mm]		110	120	142	161	185	220	274	340	380
Spacing $s = s_{min} =$ [mm]		40	50	60	80	100	120	135	150	150
	Tensile N_{Rd}: double anchor, no edge effects, min. spacing ($s = s_{min}$)									
	Non cracked concrete									
	BSt 500 S [kN]	10,6	14,5	20,8	26,9	33,9	43,1	58,5	83,9	97,1
	Cracked concrete									
	BSt 500 S [kN]	-	6,5	12,7	16,9	22,4	31,5	44,3	63,1	72,7
	Shear V_{Rd}: double anchor, no edge effects, min. spacing ($s = s_{min}$), without lever arm									
Non cracked concrete										
BSt 500 S [kN]	9,3	14,7	20,7	28,0	36,7	57,3	90,0	112,7	147,3	
Cracked concrete										
BSt 500 S [kN]	-	14,7	20,7	28,0	36,7	57,3	88,7	112,7	145,5	

Design resistance: concrete C 20/25 – $f_{ck,cube} = 25 \text{ N/mm}^2$, Temperature range I

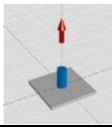
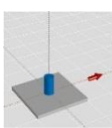
		Data according ETA-11/0493 and ETA-12/0084, issue 2013-06-20									
Anchor size		Ø8	Ø10	Ø12	Ø14	Ø16	Ø20	Ø25	Ø28	Ø32	
Embedment depth $h_{ef,2} =$ [mm]		96	120	144	168	192	240	300	336	384	
Base material thickness $h_{min} =$ [mm]		126	150	176	204	232	290	364	406	464	
	Tensile N_{Rd}: single anchor, no edge effects										
	Non cracked concrete										
	BSt 500 S [kN]	19,3	30,2	43,4	59,1	77,2	120,6	174,9	207,4	253,3	
	Cracked concrete										
	BSt 500 S [kN]	-	12,6	25,3	34,5	45,0	70,4	110,0	137,9	180,2	
	Shear V_{Rd}: single anchor, no edge effects, without lever arm										
Non cracked											
BSt 500 S [kN]	9,3	14,7	20,7	28,0	36,7	57,3	90,0	112,7	147,3		
Cracked concrete											
BSt 500 S [kN]	-	14,7	20,7	28,0	36,7	57,3	90,0	112,7	147,3		

Design resistance: concrete C 20/25 – $f_{ck,cube} = 25 \text{ N/mm}^2$, Temperature range I

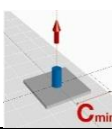
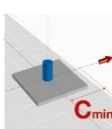
		Data according ETA-11/0493 and ETA-12/0084, issue 2013-06-20									
Anchor size		Ø8	Ø10	Ø12	Ø14	Ø16	Ø20	Ø25	Ø28	Ø32	
Embedment depth $h_{ef,2} =$ [mm]		96	120	144	168	192	240	300	336	384	
Base material thickness $h_{min} =$ [mm]		126	150	176	204	232	290	364	406	464	
Edge distance $c = c_{min} =$ [mm]		40	50	60	80	100	120	135	150	150	
	Tensile N_{Rd}: single anchor, min. edge distance ($c = c_{min}$)										
	Non cracked concrete										
	BSt 500 S [kN]	11,0	17,2	24,8	33,9	42,4	58,6	79,7	94,3	111,7	
	Cracked concrete										
	BSt 500 S [kN]	-	7,2	14,5	20,9	28,5	43,7	64,0	75,7	88,6	
	Shear V_{Rd}: single anchor, min. edge distance ($c = c_{min}$), without lever arm										
Non cracked and cracked concrete											
BSt 500 S [kN]	3,9	5,7	7,8	12,0	16,9	23,6	30,5	36,7	39,6		
Cracked concrete											
BSt 500 S [kN]	-	4,0	5,5	8,5	12,0	16,7	21,6	26,0	28,1		

Design resistance: concrete C 20/25 – $f_{ck,cube} = 25 \text{ N/mm}^2$, Temperature range I
(load values are valid for single anchor)

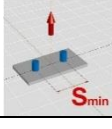
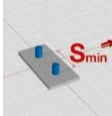
		Data according ETA-11/0493 and ETA-12/0084, issue 2013-06-20									
Anchor size		Ø8	Ø10	Ø12	Ø14	Ø16	Ø20	Ø25	Ø28	Ø32	
Embedment depth $h_{ef,2} =$ [mm]		96	120	144	168	192	240	300	336	384	
Base material thickness $h_{min} =$ [mm]		126	150	176	204	232	290	364	406	464	
Spacing $s = s_{min} =$ [mm]		40	50	60	80	100	120	135	150	150	
	Tensile N_{Rd}: double anchor, no edge effects, min. spacing ($s = s_{min}$)										
	Non cracked concrete										
	BSt 500 S [kN]	12,9	19,9	28,1	38,4	49,9	69,5	96,2	113,9	137,6	
	Cracked concrete										
	BSt 500 S [kN]	-	8,8	17,0	23,3	30,5	46,3	69,3	84,9	102,1	
	Shear V_{Rd}: double anchor, no edge effects, min. spacing ($s = s_{min}$), without lever arm										
Non cracked concrete											
BSt 500 S [kN]	9,3	14,7	20,7	28,0	36,7	57,3	90,0	112,7	147,3		
Cracked concrete											
BSt 500 S [kN]	-	14,3	20,7	28,0	36,7	57,3	90,0	112,7	147,3		

Seismic design C1

Basic loading data for concrete C20/25 – C50/60

All data in this section applies to:

- Seismic design according to TR045

The following technical data are based on: ETA-11/0493 and ETA-12/0084, issue 2013-06-20

Anchorage depth range

Anchor size		Φ8	Φ10	Φ12	Φ14	Φ16	Φ20	Φ25	Φ28	Φ32
Effective anchorage	$h_{ef,min}$ [mm]	60	60	70	75	80	90	100	112	128
depth range	$h_{ef,max}$ [mm]	160	200	240	280	320	400	500	560	640

Tension resistance in case of seismic performance category C1

Anchor size		Φ8	Φ10	Φ12	Φ14	Φ16	Φ20	Φ25	Φ28	Φ32
Characteristic tension resistance to steel failure										
Rebar B500B	$N_{Rk,s,seis}$ [kN]	-	43	62	85	111	173	270	339	442
Acc. to DIN 488:2009-08										
Partial safety factor	$\gamma_{Ms,seis}$ [-]	1,4								
Acc. to DIN 488:2009-08										
Characteristic bond resistance in cracked concrete C20/25 to C50/60										
Temp. range I: 40°C/24°C	$\tau_{Rk,seis}$ [N/mm ²]	-	4,4	6,1						
Temp. range II: 80°C/50°C	$\tau_{Rk,seis}$ [N/mm ²]	-	3,5	4,8						
Temp. range III: 120°C/72°C	$\tau_{Rk,seis}$ [N/mm ²]	-	3	4,4						
Partial safety factor	$\gamma_{Mp,seis}$ [-]	1,5								
Concrete cone resistance and splitting resistance										
Partial safety factor	$\gamma_{Mc,seis} = \gamma_{Msp,seis}$ [-]	1,5								

Displacement under tension load in case of seismic performance category C1 ¹⁾

Anchor size		Φ8	Φ10	Φ12	Φ14	Φ16	Φ20	Φ25	Φ28	Φ32
Displacement ¹⁾	$\delta_{N,seis}$ [mm]	-	1,3	1,3	1,3	1,3	1,3	1,3	1,3	1,3

1) Maximum displacement during cycling (seismic event).

Shear resistance in case of seismic performance category C1

Anchor size	Φ8	Φ10	Φ12	Φ14	Φ16	Φ20	Φ25	Φ28	Φ32
Characteristic shear resistance to steel failure									
Rebar B500B Acc. to DIN 488:2009-08 $N_{Rk,s,seis}$ [kN]	-	15	22	29	39	60	95	118	155
Partial safety factor Acc. to DIN 488:2009-08 $\gamma_{Ms,seis}$ [-]	1,5								
Concrete pryout resistance and concrete edge resistance									
Partial safety factor $\gamma_{Mcp,seis} = \gamma_{Mc,seis}$ [-]	1,5								

Displacement under shear load in case of seismic performance category C1 ¹⁾

Anchor size	Φ8	Φ10	Φ12	Φ14	Φ16	Φ20	Φ25	Φ28	Φ32
Displacement ¹⁾ $\delta_{V,seis}$ [mm]	-	3,5	3,8	4,1	4,4	5,0	5,8	6,2	6,8

1) Maximum displacement during cycling (seismic event).

For seismic resistant fastening applications please use the anchor design software PROFIS Anchor.

Hilti HIT-HY 110 mortar with HIT-V / HAS rod

Injection mortar system	Benefits
 <p>Hilti HIT-HY 110 500 ml foil pack (also available as 330 ml foil pack)</p> <p>Static mixer</p> <p>HAS rods HAS-F rods HAS-R rods HAS-HCR rods</p> <p>HAS-E rods HAS-E-R rods</p> <p>HIT-V rods HIT-V-F HIT-V-R rods HIT-V-HCR rods</p>	<ul style="list-style-type: none"> - suitable for non-cracked concrete C 20/25 to C 50/60 - suitable for dry and water saturated concrete - small edge distance and anchor spacing possible - large diameter applications - high corrosion resistant - in service temperature range up to 120°C short term/72°C long term - manual cleaning for drill hole sizes ≤ 18 mm and embedment depth $h_{ef} \leq 10d$ - embedment depth range <ul style="list-style-type: none"> M8: 60 to 160 mm M30: 120 to 600 mm



Concrete

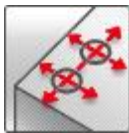

Small edge distance and spacing

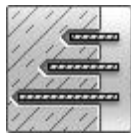

Variable embedment depth

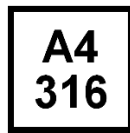

Corrosion resistance



High corrosion resistance



European Technical Approval



CE conformity

Approvals / certificates

Description	Authority / Laboratory	No. / date of issue
European Technical Approval ^{a)}	DIBt, Berlin	ETA-08/0341 / 2013-03-18

a) All data given in this section according ETA-08/0341 issue 2013-03-18.

Basic loading data (for a single anchor)

All data in this section applies to

For details see Simplified design method

- Correct setting (See setting instruction)
- No edge distance and spacing influence
- Steel failure
- Base material thickness, as specified in the table
- One typical embedment depth, as specified in the table
- One anchor material, as specified in the tables
- Concrete C 20/25, $f_{ck,cube} = 25$ N/mm²
- Temperature range I
(min. base material temperature -40°C, max. long term/short term base material temperature: +24°C/40°C)
- Installation temperature range -5°C to +40°C

Embedment depth ^{a)} and base material thickness for the basic loading data.
Mean ultimate resistance, characteristic resistance, design resistance, recommended loads.

Anchor size	M8	M10	M12	M16	M20	M24	M27	M30
Typical embedment depth h_{ef} [mm]	80	90	110	125	170	210	240	270
Base material thickness h [mm]	110	120	140	165	220	270	300	340

a) The allowed range of embedment depth is shown in the setting details. The corresponding load values can be calculated according to the simplified design method.

Mean ultimate resistance: non-cracked concrete C 20/25 , anchor HIT-V 5.8

Anchor size	M8	M10	M12	M16	M20	M24	M27	M30
Tensile $N_{Ru,m}$ HIT-V 5.8 [kN]	18,9	30,5	44,1	75,4	121,1	168,9	203,6	237,5
Shear $V_{Ru,m}$ HIT-V 5.8 [kN]	9,5	15,8	22,1	41,0	64,1	92,4	120,8	147,0

Characteristic resistance: non-cracked concrete C 20/25 , anchor HIT-V 5.8

Anchor size	M8	M10	M12	M16	M20	M24	M27	M30
Tensile N_{Rk} HIT-V 5.8 [kN]	18,0	29,0	42,0	56,5	90,8	126,7	152,7	178,1
Shear V_{Rk} HIT-V 5.8 [kN]	9,0	15,0	21,0	39,0	61,0	88,0	115,0	140,0

Design resistance: non-cracked concrete C 20/25 , anchor HIT-V 5.8

Anchor size	M8	M10	M12	M16	M20	M24	M27	M30
Tensile N_{Rd} HIT-V 5.8 [kN]	12,0	17,3	25,3	26,9	43,2	60,3	72,7	84,8
Shear V_{Rd} HIT-V 5.8 [kN]	7,2	12,0	16,8	31,2	48,8	70,4	92,0	112,0

Recommended loads ^{a)}: non-cracked concrete C 20/25 , anchor HIT-V 5.8

Anchor size	M8	M10	M12	M16	M20	M24	M27	M30
Tensile N_{rec} HIT-V 5.8 [kN]	8,6	12,3	18,1	19,2	30,9	43,1	51,9	60,6
Shear V_{rec} HIT-V 5.8 [kN]	5,1	8,6	12,0	22,3	34,9	50,3	65,7	80,0

a) With overall partial safety factor for action $\gamma = 1,4$. The partial safety factors for action depend on the type of loading and shall be taken from national regulations.

Service temperature range

Hilti HIT-HY 110 injection mortar may be applied in the temperature ranges given below. An elevated base material temperature may lead to a reduction of the design bond resistance.

Temperature range	Base material temperature	Maximum long term base material temperature	Maximum short term base material temperature
Temperature range I	-40 °C to +40 °C	+24 °C	+40 °C
Temperature range II	-40 °C to +80 °C	+50 °C	+80 °C
Temperature range III	-40 °C to +120 °C	+72 °C	+120 °C

Max short term base material temperature

Short-term elevated base material temperatures are those that occur over brief intervals, e.g. as a result of diurnal cycling.

Max long term base material temperature

Long-term elevated base material temperatures are roughly constant over significant periods of time.

Materials

Mechanical properties of HIT-V / HAS

Anchor size			M8	M10	M12	M16	M20	M24	M27	M30
Nominal tensile strength f_{uk}	HIT-V/HAS 5.8	[N/mm ²]	500	500	500	500	500	500	500	500
	HIT-V/HAS 8.8	[N/mm ²]	800	800	800	800	800	800	800	800
	HIT-V/HAS -R	[N/mm ²]	700	700	700	700	700	700	500	500
	HIT-V/HAS -HCR	[N/mm ²]	800	800	800	800	800	700	700	700
Yield strength f_{yk}	HIT-V/HAS 5.8	[N/mm ²]	400	400	400	400	400	400	400	400
	HIT-V/HAS 8.8	[N/mm ²]	640	640	640	640	640	640	640	640
	HIT-V/HAS -R	[N/mm ²]	450	450	450	450	450	450	210	210
	HIT-V/HAS -HCR	[N/mm ²]	600	600	600	600	600	400	400	400
Stressed cross-section A_s	HAS	[mm ²]	32,8	52,3	76,2	144	225	324	427	519
	HIT-V	[mm ²]	36,6	58,0	84,3	157	245	353	459	561
Moment of resistance W	HAS	[mm ³]	27,0	54,1	93,8	244	474	809	1274	1706
	HIT-V	[mm ³]	31,2	62,3	109	277	541	935	1387	1874

Material quality

Part	Material
Threaded rod HIT-V(-F), HAS(-E)(-F) 5.8: M8 – M24	Strength class 5.8, $A_5 > 8\%$ ductile steel galvanized $\geq 5 \mu\text{m}$, (F) hot dipped galvanized $\geq 45 \mu\text{m}$,
Threaded rod HIT-V(-F), HAS(-E) 8.8: M27 – M30	Strength class 8.8, $A_5 > 8\%$ ductile steel galvanized $\geq 5 \mu\text{m}$, (F) hot dipped galvanized $\geq 45 \mu\text{m}$,
Threaded rod HIT-V-R, HAS-R	Stainless steel grade A4, $A_5 > 8\%$ ductile strength class 70 for $\leq M24$ and class 50 for M27 to M30, 1.4401; 1.4404; 1.4578; 1.4571; 1.4439; 1.4362
Threaded rod HIT-V-HCR, HAS-HCR	High corrosion resistant steel, 1.4529; 1.4565 strength $\leq M20$: $R_m = 800 \text{ N/mm}^2$, $R_{p0.2} = 640 \text{ N/mm}^2$, $A_5 > 8\%$ ductile M24 to M30: $R_m = 700 \text{ N/mm}^2$, $R_{p0.2} = 400 \text{ N/mm}^2$, $A_5 > 8\%$ ductile
Washer ISO 7089	Steel galvanized, hot dipped galvanized,
	Stainless steel, 1.4401; 1.4404; 1.4578; 1.4571; 1.4439; 1.4362
	High corrosion resistant steel, 1.4529; 1.4565
Nut EN ISO 4032	Strength class 8, steel galvanized $\geq 5 \mu\text{m}$, hot dipped galvanized $\geq 45 \mu\text{m}$
	Strength class 70, stainless steel grade A4, 1.4401; 1.4404; 1.4578; 1.4571; 1.4439; 1.4362
	Strength class 70, high corrosion resistant steel, 1.4529; 1.4565

Anchor dimensions

Anchor size	M8	M10	M12	M16	M20	M24	M27	M30
Anchor rod HAS, HAS-F, HAS-R, HAS-HCR HAS-E, HAS-E-R	M8x80	M10x90	M12x110	M16x125	M20x170	M24x210	M27x240	M30x270
Embedment depth h_{ef} [mm]	80	90	110	125	170	210	240	270
Anchor rod HIT-V, HIT-V-R, HIT-V-HCR	Anchor rods HIT-V (-R / -HCR) are available in variable length							

Setting

installation equipment

Anchor size	M8	M10	M12	M16	M20	M24	M27	M30
Rotary hammer	TE 2 – TE 30				TE 40 – TE 70			
Other tools	compressed air gun or blow out pump, set of cleaning brushes, dispenser							

Setting instruction

Dry and water-saturated concrete, hammer drilling

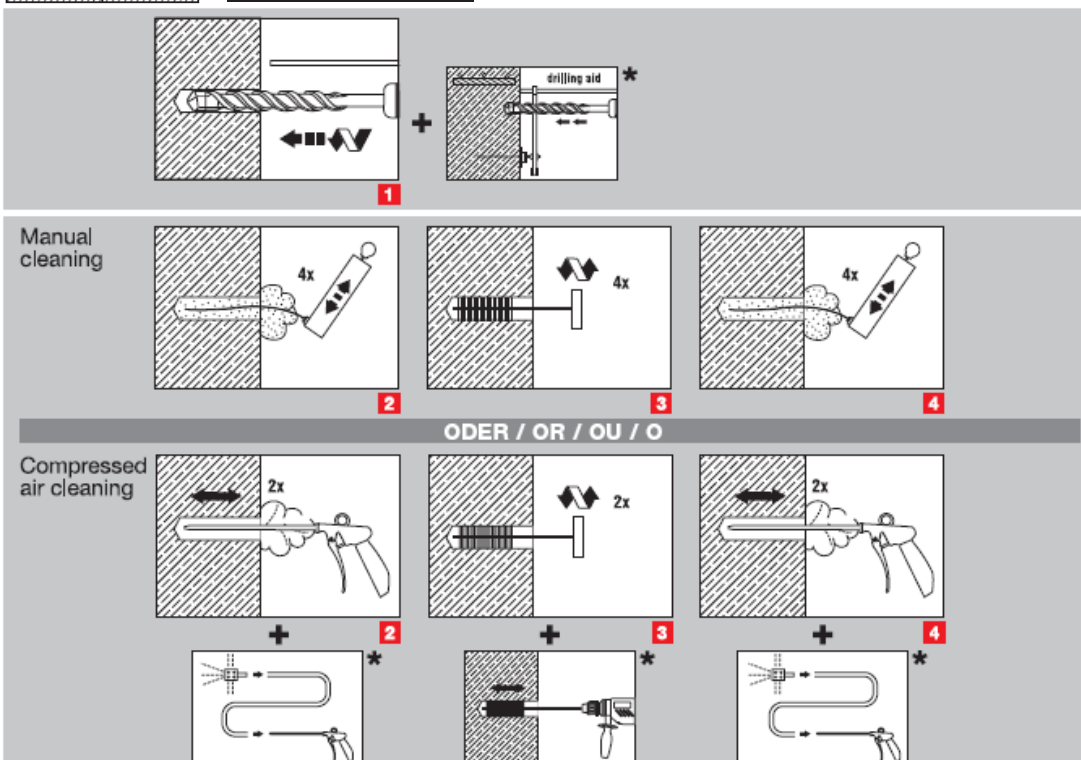

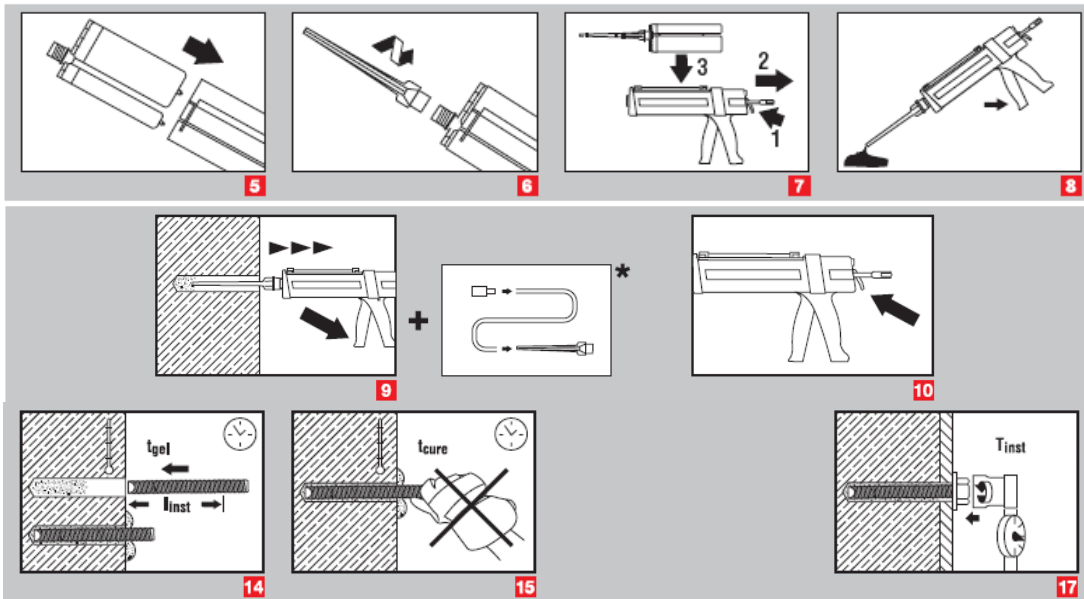

b)

a) Note: Manual cleaning for drill hole sizes $d_0 \leq 18\text{mm}$ and embedment depth $h_{ef} \leq 10 d$ only!
Compressed air cleaning for all bore hole diameters and all bore hole depth

b) Note: Extension and piston plug needed for overhead installation and/or embedment depth $> 250\text{mm}$!

For detailed information on installation see instruction for use given with the package of the product.

Working time, Curing time

Temperature of the base material T_{BM}	Working time t_{gel}	Curing time t_{cure}^a
-5 °C to -1 °C	90 min	9 h
0 °C to 4 °C	45 min	4,5 h
5 °C to 9 °C	20 min	2 h
10 °C to 19 °C	6 min	90 min
20 °C to 29 °C	4 min	50 min
30 °C to 40 °C	2 min	40 min

a) The curing time data are valid for dry anchorage base only. For water saturated anchorage bases the curing times must be doubled.

Setting details

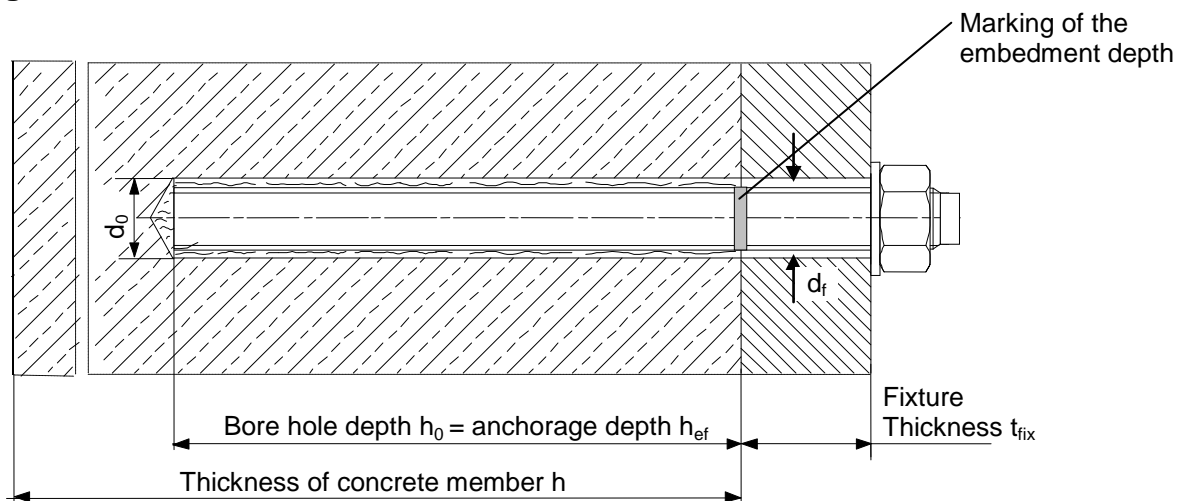

Setting details

Anchor size			M8	M10	M12	M16	M20	M24	M27	M30
Nominal diameter of drill bit	d_0	[mm]	10	12	14	18	22	28	30	35
Effective embedment and drill hole depth range ^{a)} for HIT-V	$h_{ef,min}$	[mm]	60	60	70	80	90	100	110	120
	$h_{ef,max}$	[mm]	160	200	240	320	400	480	540	600
Effective anchorage and drill hole depth for HAS	h_{ef}	[mm]	80	90	110	125	170	210	240	270
Minimum base material thickness	h_{min}	[mm]	$h_{ef} + 30 \text{ mm}$ $\geq 100 \text{ mm}$			$h_{ef} + 2 d_0$				
Diameter of clearance hole in the fixture	d_f	[mm]	9	12	14	18	22	26	30	33
Torque moment	$T_{max}^{b)}$	[Nm]	10	20	40	80	150	200	270	300
Minimum spacing	s_{min}	[mm]	40	50	60	80	100	120	135	150
Minimum edge distance	c_{min}	[mm]	40	50	60	80	100	120	135	150
Critical spacing for splitting failure	$s_{cr,sp}$	[mm]	$2 c_{cr,sp}$							
Critical edge distance for splitting failure ^{c)}	$c_{cr,sp}$	[mm]	$1,0 \cdot h_{ef}$ for $h / h_{ef} \geq 2,0$							
			$4,6 h_{ef} - 1,8 h$ for $2,0 > h / h_{ef} > 1,3$							
			$2,26 h_{ef}$ for $h / h_{ef} \leq 1,3$							
Critical spacing for concrete cone failure	$s_{cr,N}$	[mm]	$2 c_{cr,N}$							
Critical edge distance for concrete cone failure ^{d)}	$c_{cr,N}$	[mm]	$1,5 h_{ef}$							

For spacing (or edge distance) smaller than critical spacing (or critical edge distance) the design loads have to be reduced.

- Embedment depth range: $h_{ef,min} \leq h_{ef} \leq h_{ef,max}$
- Maximum recommended torque moment to avoid splitting failure during installation with minimum spacing and/or edge distance.
- h : base material thickness ($h \geq h_{min}$), h_{ef} : embedment depth
- The critical edge distance for concrete cone failure depends on the embedment depth h_{ef} and the design bond resistance. The simplified formula given in this table is on the save side.

Simplified design method

Simplified version of the design method according ETAG 001, TR 029.

- Influence of concrete strength
- Influence of edge distance
- Influence of spacing
- Valid for a group of two anchors. (The method may also be applied for anchor groups with more than two anchors or more than one edge distance. The influencing factors must then be considered for each edge distance and spacing. The calculated design loads are then on the safe side: They will be lower than the exact values according ETAG 001, TR 029. To avoid this, it is recommended to use the anchor design software PROFIS anchor)

The design method is based on the following simplification:

- No different loads are acting on individual anchors (no eccentricity)

The values are valid for one anchor.

For more complex fastening applications please use the anchor design software PROFIS Anchor.

Tension loading

The design tensile resistance is the lower value of

- Steel resistance: $N_{Rd,s}$
- Combined pull-out and concrete cone resistance: $N_{Rd,p} = N_{Rd,p}^0 \cdot f_{B,p} \cdot f_{1,N} \cdot f_{2,N} \cdot f_{3,N} \cdot f_{h,p} \cdot f_{re,N}$
- Concrete cone resistance: $N_{Rd,c} = N_{Rd,c}^0 \cdot f_B \cdot f_{1,N} \cdot f_{2,N} \cdot f_{3,N} \cdot f_{h,N} \cdot f_{re,N}$
- Concrete splitting resistance (only non-cracked concrete): $N_{Rd,sp} = N_{Rd,c}^0 \cdot f_B \cdot f_{1,sp} \cdot f_{2,sp} \cdot f_{3,sp} \cdot f_{h,N} \cdot f_{re,N}$

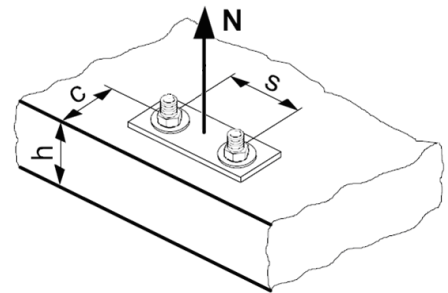

Basic design tensile resistance

Design steel resistance $N_{Rd,s}$

Anchor size		M8	M10	M12	M16	M20	M24	M27	M30
$N_{Rd,s}$	HAS 5.8 [kN]	11,3	17,3	25,3	48,0	74,7	106,7	-	-
	HIT-V 5.8 [kN]	12,0	19,3	28,0	52,7	82,0	118,0	153,3	187,3
	HAS 8.8 [kN]	-	-	-	-	-	-	231,3	281,3
	HIT-V 8.8 [kN]	19,3	30,7	44,7	84,0	130,7	188,0	244,7	299,3
	HAS (-E)-R [kN]	12,3	19,8	28,3	54,0	84,0	119,8	75,9	92,0
	HIT-V-R [kN]	13,9	21,9	31,6	58,8	92,0	132,1	80,4	98,3
	HAS (-E)-HCR [kN]	18,0	28,0	40,7	76,7	120,0	106,7	144,8	175,7
	HIT-V-HCR [kN]	19,3	30,7	44,7	84,0	130,7	117,6	152,9	187,1

Design combined pull-out and concrete cone resistance

$$N_{Rd,p} = N_{Rd,p}^0 \cdot f_{B,p} \cdot f_{1,N} \cdot f_{2,N} \cdot f_{3,N} \cdot f_{h,p} \cdot f_{re,N}$$

Anchor size		M8	M10	M12	M16	M20	M24	M27	M30
Typical embedment depth $h_{ef} = h_{ef,typ}$ [mm]		80	90	110	125	170	210	240	270
$N_{Rd,p}^0$	Temperature range I [kN]	14,7	17,3	25,3	26,9	43,2	60,3	72,7	84,8
$N_{Rd,p}^0$	Temperature range II [kN]	10,1	11,8	17,3	18,0	28,0	37,7	48,5	60,6
$N_{Rd,p}^0$	Temperature range III [kN]	8,7	10,2	15,0	15,0	25,4	33,9	38,8	48,5

Design concrete cone resistance $N_{Rd,c} = N_{Rd,c}^0 \cdot f_B \cdot f_{1,N} \cdot f_{2,N} \cdot f_{3,N} \cdot f_{h,N} \cdot f_{re,N}$

Design splitting resistance $N_{Rd,sp} = N_{Rd,c}^0 \cdot f_B \cdot f_{1,sp} \cdot f_{2,sp} \cdot f_{3,sp} \cdot f_{h,N} \cdot f_{re,N}$

Anchor size	M8	M10	M12	M16	M20	M24	M27	M30
$N_{Rd,c}^0$ [kN]	24,1	24,0	32,4	33,6	53,3	73,2	89,4	106,7

Influencing factors

Influence of concrete strength on combined pull-out and concrete cone resistance

Concrete strength designation (ENV 206)	C 20/25	C 25/30	C 30/37	C 35/45	C 40/50	C 45/55	C 50/60
$f_{B,p} = (f_{ck,cube}/25N/mm^2)^{0,15}$ a)	1,00	1,03	1,06	1,09	1,11	1,13	1,14

a) $f_{ck,cube}$ = concrete compressive strength, measured on cubes with 150 mm side length

Influence of embedment depth on combined pull-out and concrete cone resistance

$f_{h,p} = h_{ef}/h_{ef,typ}$

Influence of concrete strength on concrete cone resistance

Concrete strength designation (ENV 206)	C 20/25	C 25/30	C 30/37	C 35/45	C 40/50	C 45/55	C 50/60
$f_B = (f_{ck,cube}/25N/mm^2)^{0,5}$ a)	1	1,1	1,22	1,34	1,41	1,48	1,55

a) $f_{ck,cube}$ = concrete compressive strength, measured on cubes with 150 mm side length

Influence of edge distance a)

$c/c_{cr,N}$	0,1	0,2	0,3	0,4	0,5	0,6	0,7	0,8	0,9	1
$c/c_{cr,sp}$										
$f_{1,N} = 0,7 + 0,3 \cdot c/c_{cr,N} \leq 1$	0,73	0,76	0,79	0,82	0,85	0,88	0,91	0,94	0,97	1
$f_{1,sp} = 0,7 + 0,3 \cdot c/c_{cr,sp} \leq 1$										
$f_{2,N} = 0,5 \cdot (1 + c/c_{cr,N}) \leq 1$	0,55	0,60	0,65	0,70	0,75	0,80	0,85	0,90	0,95	1
$f_{2,sp} = 0,5 \cdot (1 + c/c_{cr,sp}) \leq 1$										

a) The edge distance shall not be smaller than the minimum edge distance c_{min} . These influencing factors must be considered for every edge distance smaller than the critical edge distance.

Influence of anchor spacing a)

$s/s_{cr,N}$	0,1	0,2	0,3	0,4	0,5	0,6	0,7	0,8	0,9	1
$s/s_{cr,sp}$										
$f_{3,N} = 0,5 \cdot (1 + s/s_{cr,N}) \leq 1$	0,55	0,60	0,65	0,70	0,75	0,80	0,85	0,90	0,95	1
$f_{3,sp} = 0,5 \cdot (1 + s/s_{cr,sp}) \leq 1$										

a) The anchor spacing shall not be smaller than the minimum anchor spacing s_{min} . This influencing factor must be considered for every anchor spacing.

Influence of embedment depth on concrete cone resistance

$f_{h,N} = (h_{ef}/h_{ef,typ})^{1,5}$

Influence of reinforcement

h_{ef} [mm]	40	50	60	70	80	90	≥ 100
$f_{re,N} = 0,5 + h_{ef}/200\text{mm} \leq 1$	0,7 ^{a)}	0,75 ^{a)}	0,8 ^{a)}	0,85 ^{a)}	0,9 ^{a)}	0,95 ^{a)}	1

a) This factor applies only for dense reinforcement. If in the area of anchorage there is reinforcement with a spacing ≥ 150 mm (any diameter) or with a diameter ≤ 10 mm and a spacing ≥ 100 mm, then a factor $f_{re,N} = 1$ may be applied.

Shear loading

The design shear resistance is the lower value of

- Steel resistance: $V_{Rd,s}$
- Concrete pryout resistance: $V_{Rd,cp} = k \cdot \text{lower value of } N_{Rd,p} \text{ and } N_{Rd,c}$
- Concrete edge resistance: $V_{Rd,c} = V_{Rd,c}^0 \cdot f_B \cdot f_{\beta} \cdot f_h \cdot f_4 \cdot f_{hef} \cdot f_c$

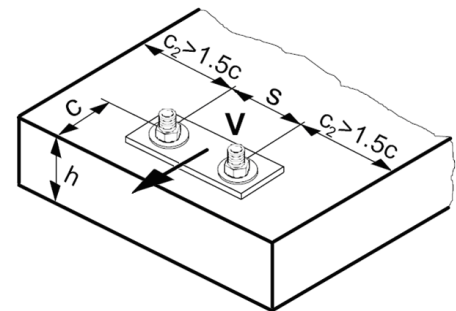

Basic design shear resistance

Design steel resistance $V_{Rd,s}$

Anchor size		M8	M10	M12	M16	M20	M24	M27	M30
$V_{Rd,s}$	HAS 5.8 [kN]	6,8	10,4	15,2	28,8	44,8	64,0	-	-
	HIT-V 5.8 [kN]	7,2	12,0	16,8	31,2	48,8	70,4	92,0	112,0
	HAS 8.8 [kN]	-	-	-	-	-	-	139,2	168,8
	HIT-V 8.8 [kN]	12,0	18,4	27,2	50,4	78,4	112,8	147,2	179,2
	HAS (-E)-R [kN]	7,7	12,2	17,3	32,7	50,6	71,8	45,8	55,5
	HIT-V-R [kN]	8,3	12,8	19,2	35,3	55,1	79,5	48,3	58,8
	HAS (-E)-HCR [kN]	10,4	16,8	24,8	46,4	72,0	64,0	86,9	105,7
	HIT-V-HCR [kN]	12,0	18,4	27,2	50,4	78,4	70,9	92,0	112,0

Design concrete pryout resistance $V_{Rd,cp} = \text{lower value}^a)$ of $k \cdot N_{Rd,p}$ and $k \cdot N_{Rd,c}$

$$k = 2 \text{ for } h_{ef} \geq 60 \text{ mm}$$

- a) $N_{Rd,p}$: Design combined pull-out and concrete cone resistance
 $N_{Rd,c}$: Design concrete cone resistance

Design concrete edge resistance $V_{Rd,c} = V_{Rd,c}^0 \cdot f_B \cdot f_{\beta} \cdot f_h \cdot f_4 \cdot f_{hef} \cdot f_c$

Anchor size		M8	M10	M12	M16	M20	M24	M27	M30
Non-cracked concrete									
$V_{Rd,c}^0$	[kN]	5,9	8,6	11,6	18,7	27,0	36,6	44,5	53,0

Influencing factors

Influence of concrete strength

Concrete strength designation (ENV 206)	C 20/25	C 25/30	C 30/37	C 35/45	C 40/50	C 45/55	C 50/60
$f_B = (f_{ck,cube}/25N/mm^2)^{1/2}$ a)	1	1,1	1,22	1,34	1,41	1,48	1,55

a) $f_{ck,cube}$ = concrete compressive strength, measured on cubes with 150 mm side length

Influence of angle between load applied and the direction perpendicular to the free edge

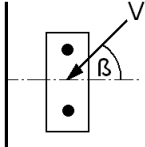
Angle β	0°	10°	20°	30°	40°	50°	60°	70°	80°	≥ 90°
$f_\beta = \sqrt{\frac{1}{(\cos \alpha_V)^2 + \left(\frac{\sin \alpha_V}{2,5}\right)^2}}$ 	1	1,01	1,05	1,13	1,24	1,40	1,64	1,97	2,32	2,50

Influence of base material thickness

h/c	0,15	0,3	0,45	0,6	0,75	0,9	1,05	1,2	1,35	≥ 1,5
$f_h = \{h/(1,5 \cdot c)\}^{1/2} \leq 1$	0,32	0,45	0,55	0,63	0,71	0,77	0,84	0,89	0,95	1,00

Influence of anchor spacing and edge distance ^{a)} for concrete edge resistance: f_4

$$f_4 = (c/h_{ef})^{1,5} \cdot (1 + s / [3 \cdot c]) \cdot 0,5$$

c/h _{ef}	Single anchor	Group of two anchors s/h _{ef}														
		0,75	1,50	2,25	3,00	3,75	4,50	5,25	6,00	6,75	7,50	8,25	9,00	9,75	10,50	11,25
0,50	0,35	0,27	0,35	0,35	0,35	0,35	0,35	0,35	0,35	0,35	0,35	0,35	0,35	0,35	0,35	0,35
0,75	0,65	0,43	0,54	0,65	0,65	0,65	0,65	0,65	0,65	0,65	0,65	0,65	0,65	0,65	0,65	0,65
1,00	1,00	0,63	0,75	0,88	1,00	1,00	1,00	1,00	1,00	1,00	1,00	1,00	1,00	1,00	1,00	1,00
1,25	1,40	0,84	0,98	1,12	1,26	1,40	1,40	1,40	1,40	1,40	1,40	1,40	1,40	1,40	1,40	1,40
1,50	1,84	1,07	1,22	1,38	1,53	1,68	1,84	1,84	1,84	1,84	1,84	1,84	1,84	1,84	1,84	1,84
1,75	2,32	1,32	1,49	1,65	1,82	1,98	2,15	2,32	2,32	2,32	2,32	2,32	2,32	2,32	2,32	2,32
2,00	2,83	1,59	1,77	1,94	2,12	2,30	2,47	2,65	2,83	2,83	2,83	2,83	2,83	2,83	2,83	2,83
2,25	3,38	1,88	2,06	2,25	2,44	2,63	2,81	3,00	3,19	3,38	3,38	3,38	3,38	3,38	3,38	3,38
2,50	3,95	2,17	2,37	2,57	2,77	2,96	3,16	3,36	3,56	3,76	3,95	3,95	3,95	3,95	3,95	3,95
2,75	4,56	2,49	2,69	2,90	3,11	3,32	3,52	3,73	3,94	4,15	4,35	4,56	4,56	4,56	4,56	4,56
3,00	5,20	2,81	3,03	3,25	3,46	3,68	3,90	4,11	4,33	4,55	4,76	4,98	5,20	5,20	5,20	5,20
3,25	5,86	3,15	3,38	3,61	3,83	4,06	4,28	4,51	4,73	4,96	5,18	5,41	5,63	5,86	5,86	5,86
3,50	6,55	3,51	3,74	3,98	4,21	4,44	4,68	4,91	5,14	5,38	5,61	5,85	6,08	6,31	6,55	6,55
3,75	7,26	3,87	4,12	4,36	4,60	4,84	5,08	5,33	5,57	5,81	6,05	6,29	6,54	6,78	7,02	7,26
4,00	8,00	4,25	4,50	4,75	5,00	5,25	5,50	5,75	6,00	6,25	6,50	6,75	7,00	7,25	7,50	7,75
4,25	8,76	4,64	4,90	5,15	5,41	5,67	5,93	6,18	6,44	6,70	6,96	7,22	7,47	7,73	7,99	8,25
4,50	9,55	5,04	5,30	5,57	5,83	6,10	6,36	6,63	6,89	7,16	7,42	7,69	7,95	8,22	8,49	8,75
4,75	10,35	5,45	5,72	5,99	6,27	6,54	6,81	7,08	7,36	7,63	7,90	8,17	8,45	8,72	8,99	9,26
5,00	11,18	5,87	6,15	6,43	6,71	6,99	7,27	7,55	7,83	8,11	8,39	8,66	8,94	9,22	9,50	9,78
5,25	12,03	6,30	6,59	6,87	7,16	7,45	7,73	8,02	8,31	8,59	8,88	9,17	9,45	9,74	10,02	10,31
5,50	12,90	6,74	7,04	7,33	7,62	7,92	8,21	8,50	8,79	9,09	9,38	9,67	9,97	10,26	10,55	10,85

a) The anchor spacing and the edge distance shall not be smaller than the minimum anchor spacing s_{min} and the minimum edge distance c_{min} .

Influence of embedment depth

h_{ef}/d	4	4,5	5	6	7	8	9	10	11
$f_{hef} = 0,05 \cdot (h_{ef} / d)^{1,68}$	0,51	0,63	0,75	1,01	1,31	1,64	2,00	2,39	2,81
h_{ef}/d	12	13	14	15	16	17	18	19	20
$f_{hef} = 0,05 \cdot (h_{ef} / d)^{1,68}$	3,25	3,72	4,21	4,73	5,27	5,84	6,42	7,04	7,67

Influence of edge distance ^{a)}

c/d	4	6	8	10	15	20	30	40
$f_c = (d / c)^{0,19}$	0,77	0,71	0,67	0,65	0,60	0,57	0,52	0,50

a) The edge distance shall not be smaller than the minimum edge distance c_{min} .

Combined tension and shear loading

For combined tension and shear loading see section "Anchor Design".

Precalculated values – design resistance values

All data applies to:

- non-cracked concrete C 20/25 – $f_{ck,cube} = 25 \text{ N/mm}^2$
- temperature range I (see Service temperature range)
- minimum thickness of base material
- no effects of dense reinforcement

Recommended loads can be calculated by dividing the design resistance by an overall partial safety factor for action $\gamma = 1,4$. The partial safety factors for action depend on the type of loading and shall be taken from national regulations.

Design resistance: concrete C 20/25 – $f_{ck,cube} = 25 \text{ N/mm}^2$ - minimum embedment depth

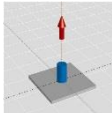
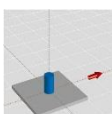
Anchor size	M8	M10	M12	M16	M20	M24	M27	M30
Embedment depth $h_{ef} = h_{ef,min}$ [mm]	60	60	70	80	90	100	110	120
Base material thickness $h = h_{min}$ [mm]	100	100	100	116	138	156	170	190
 Tensile N_{Rd}: single anchor, no edge effects								
HIT-V 5.8 HIT-V 8.8 HIT-V-R HIT-V-HCR [kN]	11,1	11,5	16,1	17,2	20,5	24,0	27,7	31,6
 Shear V_{Rd}: single anchor, no edge effects, without lever arm								
HIT-V 5.8 [kN]	7,2	12,0	16,8	31,2	48,8	67,3	77,7	88,5
HIT-V 8.8 [kN]	12,0	18,4	27,2	48,2	57,5	67,3	77,7	88,5
HIT-V-R [kN]	8,3	12,8	19,2	35,3	55,1	67,3	48,3	58,8
HIT-V-HCR [kN]	12,0	18,4	27,2	48,2	57,5	67,3	77,7	88,5

Design resistance: concrete C 20/25 – $f_{ck,cube} = 25 \text{ N/mm}^2$ - minimum embedment depth

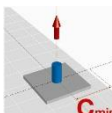
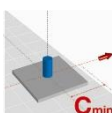
Anchor size	M8	M10	M12	M16	M20	M24	M27	M30
Embedment depth $h_{ef} = h_{ef,min}$ [mm]	60	60	70	80	90	100	110	120
Base material thickness $h = h_{min}$ [mm]	100	100	100	116	138	156	170	190
Edge distance $c = c_{min}$ [mm]	40	50	60	80	100	120	135	150
 Tensile N_{Rd}: single anchor, min. edge distance ($c = c_{min}$)								
HIT-V 5.8 HIT-V 8.8 HIT-V-R HIT-V-HCR [kN]	6,7	7,8	9,7	11,0	14,5	18,1	21,0	24,8
 Shear V_{Rd}: single anchor, min. edge distance ($c = c_{min}$), without lever arm								
HIT-V 5.8 HIT-V 8.8 HIT-V-R HIT-V-HCR [kN]	3,5	4,9	6,6	10,2	14,1	18,3	21,8	25,9

**Design resistance: concrete C 20/25 – $f_{ck,cube} = 25 \text{ N/mm}^2$ - minimum embedment depth
(load values are valid for single anchor)**

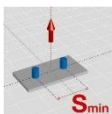
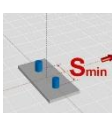
Anchor size	M8	M10	M12	M16	M20	M24	M27	M30
Embedment depth $h_{ef} = h_{ef,min}$ [mm]	60	60	70	80	90	100	110	120
Base material thickness $h = h_{min}$ [mm]	100	100	100	116	138	156	170	190
Spacing $s = s_{min}$ [mm]	40	50	60	80	100	120	135	150
 Tensile N_{Rd}: double anchor, no edge effects, min. spacing ($s = s_{min}$)								
HIT-V 5.8 HIT-V 8.8 HIT-V-R HIT-V-HCR [kN]	7,4	7,6	10,0	10,8	13,4	16,0	18,6	21,5
 Shear V_{Rd}: double anchor, no edge effects, min. spacing ($s = s_{min}$), without lever arm								
HIT-V 5.8 [kN]	7,2	12,0	16,8	31,2	39,4	47,1	54,7	62,7
HIT-V 8.8 [kN]	12,0	17,7	24,9	32,1	39,4	47,1	54,7	62,7
HIT-V-R [kN]	8,3	12,8	19,2	32,1	39,4	47,1	48,3	58,8
HIT-V-HCR [kN]	12,0	17,7	24,9	32,1	39,4	47,1	54,7	62,7

Design resistance: concrete C 20/25 – $f_{ck,cube} = 25 \text{ N/mm}^2$ - typical embedment depth

Anchor size		M8	M10	M12	M16	M20	M24	M27	M30	
Embedment depth $h_{ef} = h_{ef,typ}$ [mm]		80	90	110	125	170	210	240	270	
Base material thickness $h = h_{min}$ [mm]		110	120	140	161	218	266	300	340	
	Tensile N_{Rd}: single anchor, no edge effects									
	HIT-V 5.8 [kN]	12,0	17,3	25,3	26,9	43,2	60,3	72,7	84,8	
	HIT-V 8.8 [kN]	14,7	17,3	25,3	26,9	43,2	60,3	72,7	84,8	
	HIT-V-R [kN]	13,9	17,3	25,3	26,9	43,2	60,3	72,7	84,8	
	HIT-V-HCR [kN]	14,7	17,3	25,3	26,9	43,2	60,3	72,7	84,8	
	Shear V_{Rd}: single anchor, no edge effects, without lever arm									
	HIT-V 5.8 [kN]	7,2	12,0	16,8	31,2	48,8	70,4	92,0	112,0	
	HIT-V 8.8 [kN]	12,0	18,4	27,2	50,4	78,4	112,8	147,2	179,2	
	HIT-V-R [kN]	8,3	12,8	19,2	35,3	55,1	79,5	48,3	58,8	
	HIT-V-HCR [kN]	12,0	18,4	27,2	50,4	78,4	70,9	92,0	112,0	

Design resistance: concrete C 20/25 – $f_{ck,cube} = 25 \text{ N/mm}^2$ - typical embedment depth

Anchor size		M8	M10	M12	M16	M20	M24	M27	M30	
Embedment depth $h_{ef} = h_{ef,typ}$ [mm]		80	90	110	125	170	210	240	270	
Base material thickness $h = h_{min}$ [mm]		110	120	140	161	218	266	300	340	
Edge distance $c = c_{min}$ [mm]		40	50	60	80	100	120	135	150	
	Tensile N_{Rd}: single anchor, min. edge distance ($c = c_{min}$)									
	HIT-V 5.8 [kN]									
	HIT-V 8.8 [kN]	8,6	10,1	14,7	16,4	26,7	37,8	46,3	55,0	
	HIT-V-R [kN]									
	HIT-V-HCR [kN]									
	Shear V_{Rd}: single anchor, min. edge distance ($c = c_{min}$), without lever arm									
	HIT-V 5.8 [kN]									
	HIT-V 8.8 [kN]	3,7	5,3	7,3	11,5	17,2	23,6	29,0	34,8	
	HIT-V-R [kN]									
	HIT-V-HCR [kN]									

**Design resistance: concrete C 20/25 – $f_{ck,cube} = 25 \text{ N/mm}^2$ - typical embedment depth
(load values are valid for single anchor)**

Anchor size		M8	M10	M12	M16	M20	M24	M27	M30	
Embedment depth $h_{ef} = h_{ef,typ}$ [mm]		80	90	110	125	170	210	240	270	
Base material thickness $h = h_{min}$ [mm]		110	120	140	161	218	266	300	340	
Spacing s [mm]		40	50	60	80	100	120	135	150	
	Tensile N_{Rd}: double anchor, no edge effects, min. spacing ($s = s_{min}$)									
	HIT-V 5.8 [kN]									
	HIT-V 8.8 [kN]	9,9	11,3	16,3	17,5	28,2	39,4	47,9	56,5	
	HIT-V-R [kN]									
	HIT-V-HCR [kN]									
	Shear V_{Rd}: double anchor, no edge effects, min. spacing ($s = s_{min}$), without lever arm									
	HIT-V 5.8 [kN]	7,2	12,0	16,8	31,2	48,8	70,4	92,0	112,0	
	HIT-V 8.8 [kN]	12,0	18,4	27,2	45,7	72,4	100,5	120,9	140,7	
	HIT-V-R [kN]	8,3	12,8	19,2	35,3	55,1	79,5	48,3	58,8	
	HIT-V-HCR [kN]	12,0	18,4	27,2	45,7	72,4	70,9	92,0	112,0	

Design resistance: concrete C 20/25 – $f_{ck,cube} = 25 \text{ N/mm}^2$ - embedment depth = 12 d^{a)}

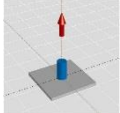
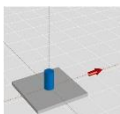
Anchor size	M8	M10	M12	M16	M20	M24	M27	M30
Embedment depth $h_{ef} = 12 d^a)$ [mm]	96	120	144	192	240	288	324	360
Base material thickness $h = h_{min}$ [mm]	126	150	174	228	288	344	384	430
 Tensile N_{Rd}: single anchor, no edge effects								
HIT-V 5.8 [kN]	12,0	19,3	28,0	41,4	61,0	82,7	98,2	113,1
HIT-V 8.8 [kN]	17,7	23,0	33,2	41,4	61,0	82,7	98,2	113,1
HIT-V-R [kN]	13,9	21,9	31,6	41,4	61,0	82,7	80,4	98,3
HIT-V-HCR [kN]	17,7	23,0	33,2	41,4	61,0	82,7	98,2	113,1
 Shear V_{Rd}: single anchor, no edge effects, without lever arm								
HIT-V 5.8 [kN]	7,2	12,0	16,8	31,2	48,8	70,4	92,0	112,0
HIT-V 8.8 [kN]	12,0	18,4	27,2	50,4	78,4	112,8	147,2	179,2
HIT-V-R [kN]	8,3	12,8	19,2	35,3	55,1	79,5	48,3	58,8
HIT-V-HCR [kN]	12,0	18,4	27,2	50,4	78,4	70,9	92,0	112,0

a) d = element diameter

Design resistance: concrete C 20/25 – $f_{ck,cube} = 25 \text{ N/mm}^2$ - embedment depth = 12 d^{a)}

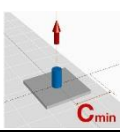
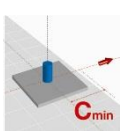
Anchor size	M8	M10	M12	M16	M20	M24	M27	M30
Embedment depth $h_{ef} = 12 d^a)$ [mm]	96	120	144	192	240	288	324	360
Base material thickness $h = h_{min}$ [mm]	126	150	174	228	288	344	384	430
Edge distance $c = c_{min}$ [mm]	40	50	60	80	100	120	135	150
 Tensile N_{Rd}: single anchor, min. edge distance ($c = c_{min}$)								
HIT-V 5.8 [kN]								
HIT-V 8.8 [kN]	10,3	13,4	19,3	25,2	37,7	51,9	62,6	73,4
HIT-V-R [kN]								
HIT-V-HCR [kN]								
 Shear V_{Rd}: single anchor, min. edge distance ($c = c_{min}$), without lever arm								
HIT-V 5.8 [kN]								
HIT-V 8.8 [kN]	3,9	5,7	7,8	12,9	18,9	25,9	31,8	38,1
HIT-V-R [kN]								
HIT-V-HCR [kN]								

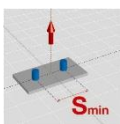
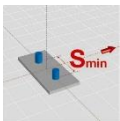

a) d = element diameter

Design resistance: concrete C 20/25 – $f_{ck,cube} = 25 \text{ N/mm}^2$ - embedment depth = 12 d^{a)}
(load values are valid for single anchor)

Anchor size	M8	M10	M12	M16	M20	M24	M27	M30
Embedment depth $h_{ef} = 12 d^a)$ [mm]	96	120	144	192	240	288	324	360
Base material thickness $h = h_{min}$ [mm]	126	150	174	228	288	344	384	430
Spacing $s = s_{min}$ [mm]	40	50	60	80	100	120	135	150
 Tensile N_{Rd}: double anchor, no edge effects, min. spacing ($s = s_{min}$)								
HIT-V 5.8 [kN]	12,0	15,5	22,0	28,0	41,2	55,8	66,6	77,3
HIT-V 8.8 [kN]								
HIT-V-R [kN]	12,1	15,5	22,0	28,0	41,2	55,8	66,6	77,3
HIT-V-HCR [kN]								
 Shear V_{Rd}: double anchor, no edge effects, min. spacing ($s = s_{min}$), without lever arm								
HIT-V 5.8 [kN]	7,2	12,0	16,8	31,2	48,8	70,4	92,0	112,0
HIT-V 8.8 [kN]	12,0	18,4	27,2	50,4	78,4	112,8	147,2	179,2
HIT-V-R [kN]	8,3	12,8	19,2	35,3	55,1	79,5	48,3	58,8
HIT-V-HCR [kN]	12,0	18,4	27,2	50,4	78,4	70,9	92,0	112,0

a) d = element diameter

Hilti HIT-HY 110 mortar with HIS-(R)N sleeve

Injection mortar system		Benefits
	Hilti HIT-HY 110 500 ml foil pack (also available as 330 ml foil pack)	<ul style="list-style-type: none"> - suitable for non-cracked concrete C 20/25 to C 50/60 - suitable for dry and water saturated concrete - small edge distance and anchor spacing possible - corrosion resistant - in service temperature range up to 120°C short term/72°C long term - manual cleaning for drill hole sizes ≤ 18 mm
	Static mixer	
	Internal threaded sleeve HIS-N HIS-RN	



Concrete

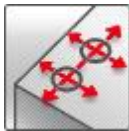

Small edge distance and spacing

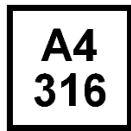

Corrosion resistance



European Technical Approval



CE conformity

Approvals / certificates

Description	Authority / Laboratory	No. / date of issue
European Technical Approval ^{a)}	DIBt, Berlin	ETA-08/0341 / 2013-03-18

a) All data given in this section according ETA-08/0341 issue 2013-03-18.

Basic loading data (for a single anchor)

All data in this section applies to

For details see Simplified design method

- Correct setting (See setting instruction)
- No edge distance and spacing influence
- Steel failure
- Base material thickness, as specified in the table
- One anchor material, as specified in the tables
- Concrete C 20/25, $f_{ck,cube} = 25$ N/mm²
- Temperate range I
(min. base material temperature -40°C, max. long term/short term base material temperature: +24°C/40°C)
- Installation temperature range -5°C to +40°C

Embedment depth and base material thickness for the basic loading data.
Mean ultimate resistance, characteristic resistance, design resistance, recommended loads.

Anchor size		M8x90	M10x110	M12x125	M16x170	M20x205
Embedment depth	h_{ef} [mm]	90	110	125	170	205
Base material thickness	h [mm]	120	150	170	230	270

Mean ultimate resistance: non-cracked concrete C 20/25 , anchor HIS-N

Anchor size		M8x90	M10x110	M12x125	M16x170	M20x205
Tensile $N_{R_{u,m}}$	HIS-N [kN]	26,3	48,3	70,4	123,9	114,5
Shear $V_{R_{u,m}}$	HIS-N [kN]	13,7	24,2	41,0	62,0	57,8

Characteristic resistance: non-cracked concrete C 20/25 , anchor HIS-N

Anchor size		M8x90	M10x110	M12x125	M16x170	M20x205
Tensile N_{Rk}	HIS-N [kN]	25,0	40,0	60,0	111,9	109,0
Shear V_{Rk}	HIS-N [kN]	13,0	23,0	39,0	59,0	55,0

Design resistance: non-cracked concrete C 20/25 , anchor HIS-N

Anchor size		M8x90	M10x110	M12x125	M16x170	M20x205
Tensile N_{Rd}	HIS-N [kN]	17,5	26,7	40,0	62,2	74,1
Shear V_{Rd}	HIS-N [kN]	10,4	18,4	26,0	39,3	36,7

Recommended loads ^{a)}: non-cracked concrete C 20/25 , anchor HIS-N

Anchor size		M8x90	M10x110	M12x125	M16x170	M20x205
Tensile N_{rec}	HIS-N [kN]	12,5	19,0	28,6	44,4	53,0
Shear V_{rec}	HIS-N [kN]	7,4	13,1	18,6	28,1	26,2

a) With overall partial safety factor for action $\gamma = 1,4$. The partial safety factors for action depend on the type of loading and shall be taken from national regulations.

Service temperature range

Hilti HIT-HY 110 injection mortar may be applied in the temperature ranges given below. An elevated base material temperature may lead to a reduction of the design bond resistance.

Temperature range	Base material temperature	Maximum long term base material temperature	Maximum short term base material temperature
Temperature range I	-40 °C to +40 °C	+24 °C	+40 °C
Temperature range II	-40 °C to +80 °C	+50 °C	+80 °C
Temperature range III	-40 °C to +120 °C	+72 °C	+120 °C

Max short term base material temperature

Short-term elevated base material temperatures are those that occur over brief intervals, e.g. as a result of diurnal cycling.

Max long term base material temperature

Long-term elevated base material temperatures are roughly constant over significant periods of time.

Materials

Mechanical properties of HIS-(R)N

Anchor size			M8x90	M10x110	M12x125	M16x170	M20x205
Nominal tensile strength f_{uk}	HIS-N	[N/mm ²]	490	490	460	460	460
	Screw 8.8	[N/mm ²]	800	800	800	800	800
	HIS-RN	[N/mm ²]	700	700	700	700	700
	Screw A4-70	[N/mm ²]	700	700	700	700	700
Yield strength f_{yk}	HIS-N	[N/mm ²]	410	410	375	375	375
	Screw 8.8	[N/mm ²]	640	640	640	640	640
	HIS-RN	[N/mm ²]	350	350	350	350	350
	Screw A4-70	[N/mm ²]	450	450	450	450	450
Stressed cross-section A_s	HIS-(R)N	[mm ²]	51,5	108,0	169,1	256,1	237,6
	Screw	[mm ²]	36,6	58	84,3	157	245
Moment of resistance W	HIS-(R)N	[mm ³]	145	430	840	1595	1543
	Screw	[mm ³]	31,2	62,3	109	277	541

Material quality

Part	Material
Internal threaded sleeve ^{a)} HIS-N	C-steel 1.0718, Steel galvanized $\geq 5\mu\text{m}$
Internal threaded sleeve ^{a)} HIS-RN	Stainless steel 1.4401 and 1.4571

- a) related fastening screw: strength class 8.8, A5 > 8% Ductile
steel galvanized $\geq 5\mu\text{m}$
- b) related fastening screw: strength class 70, A5 > 8% Ductile
stainless steel 1.4401; 1.4404; 1.4578; 1.4571; 1.4439; 1.4362

Anchor dimensions

Anchor size		M8x90	M10x110	M12x125	M16x170	M20x205
Internal threaded sleeve HIS-N / HIS-RN						
Embedment depth	h_{ef} [mm]	80	90	110	125	170

Setting

installation equipment

Anchor size	M8x90	M10x110	M12x125	M16x170	M20x205
Rotary hammer	TE 2 – TE 30		TE 40 – TE 70		
Other tools	compressed air gun or blow out pump, set of cleaning brushes, dispenser				

Setting instruction

Dry and water-saturated concrete, hammer drilling

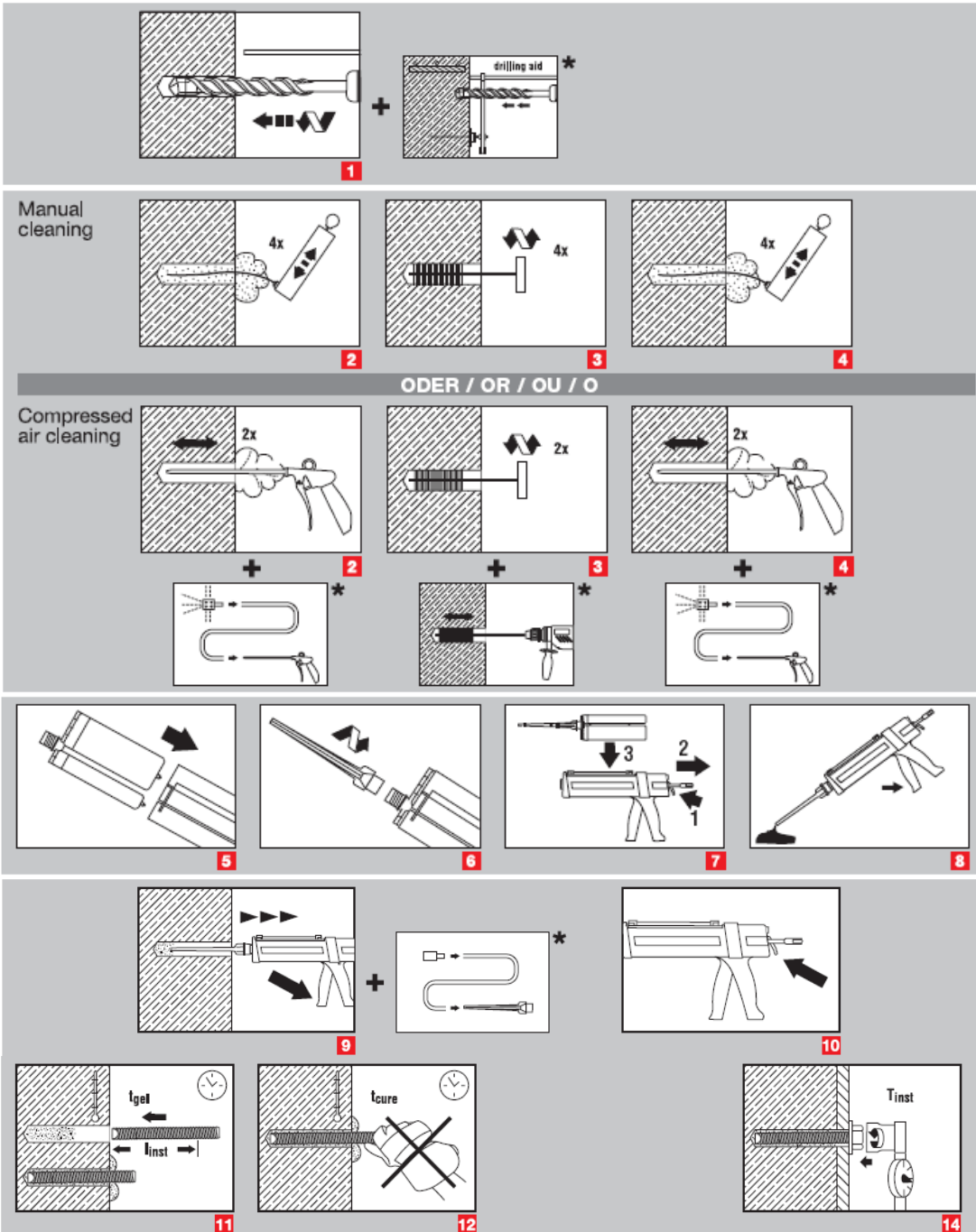
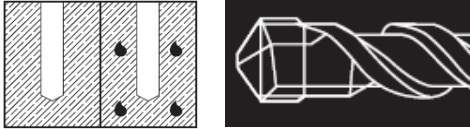

a)

b)

a) Note: Manual cleaning for drill hole sizes $d_0 \leq 18\text{mm}$ only!

Compressed air cleaning for all bore hole diameters and all bore hole depth

b) Note: Extension and piston plug needed for overhead installation!

For detailed information on installation see instruction for use given with the package of the product.

Working time, Curing time

Temperature of the base material T_{BM}	Working time t_{gel}	Curing time $t_{cure}^{a)}$
-5 °C to -1 °C	90 min	9 h
0 °C to 4 °C	45 min	4,5 h
5 °C to 9 °C	20 min	2 h
10 °C to 19 °C	6 min	90 min
20 °C to 29 °C	4 min	50 min
30 °C to 40 °C	2 min	40 min

a) The curing time data are valid for dry anchorage base only. For water saturated anchorage bases the curing times must be doubled.

Setting details

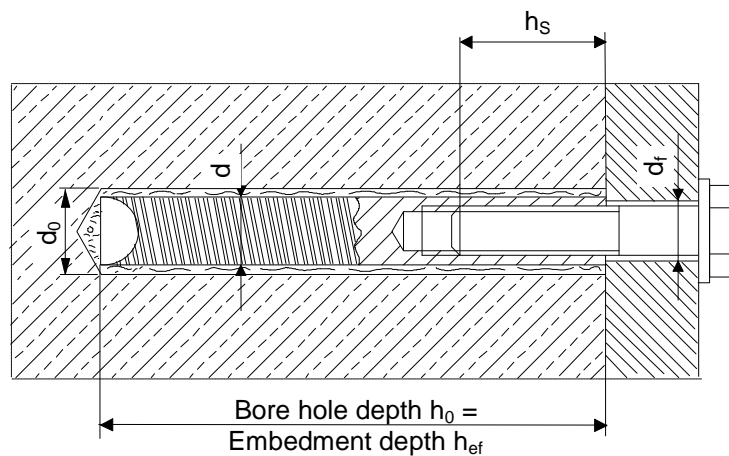

Anchor size			M8x90	M10x110	M12x125	M16x170	M20x205	
Nominal diameter of drill bit	d_0	[mm]	14	18	22	28	32	
Diameter of element	d	[mm]	12,5	16,5	20,5	25,4	27,6	
Effective anchorage and drill hole depth	h_{ef}	[mm]	90	110	125	170	205	
Minimum base material thickness	h_{min}	[mm]	120	150	170	230	270	
Diameter of clearance hole in the fixture	d_f	[mm]	9	12	14	18	22	
Thread engagement length; min - max	h_s	[mm]	8-20	10-25	12-30	16-40	20-50	
Torque moment ^{a)}	T_{max}	[Nm]	10	20	40	80	150	
Minimum spacing	s_{min}	[mm]	40	45	55	65	90	
Minimum edge distance	c_{min}	[mm]	40	45	55	65	90	
Critical spacing for splitting failure	$s_{cr,sp}$	[mm]	$2 c_{cr,sp}$					
Critical edge distance for splitting failure ^{b)}	$c_{cr,sp}$	[mm]	$1,0 \cdot h_{ef}$ for $h / h_{ef} \geq 2,0$					
			$4,6 h_{ef} - 1,8 h$ for $2,0 > h / h_{ef} > 1,3$					
			$2,26 h_{ef}$ for $h / h_{ef} \leq 1,3$					
Critical spacing for concrete cone failure	$s_{cr,N}$	[mm]	$2 c_{cr,N}$					
Critical edge distance for concrete cone failure ^{c)}	$c_{cr,N}$	[mm]	$1,5 h_{ef}$					

For spacing (or edge distance) smaller than critical spacing (or critical edge distance) the design loads have to be reduced.

- a) Maximum recommended torque moment to avoid splitting failure during installation with minimum spacing and/or edge distance.
- b) h : base material thickness ($h \geq h_{min}$), h_{ef} : embedment depth
- c) The critical edge distance for concrete cone failure depends on the embedment depth h_{ef} and the design bond resistance. The simplified formula given in this table is on the safe side.

Simplified design method

Simplified version of the design method according ETAG 001, TR 029.

- Influence of concrete strength
- Influence of edge distance
- Influence of spacing
- Valid for a group of two anchors. (The method may also be applied for anchor groups with more than two anchors or more than one edge distance. The influencing factors must then be considered for each edge distance and spacing. The calculated design loads are then on the safe side: They will be lower than the exact values according ETAG 001, TR 029. To avoid this, it is recommended to use the anchor design software PROFIS anchor)

The design method is based on the following simplification:

- No different loads are acting on individual anchors (no eccentricity)

The values are valid for one anchor.

For more complex fastening applications please use the anchor design software PROFIS Anchor.

Tension loading

The design tensile resistance is the lower value of

- Steel resistance: $N_{Rd,s}$
- Combined pull-out and concrete cone resistance:
 $N_{Rd,p} = N_{Rd,p}^0 \cdot f_{B,p} \cdot f_{1,N} \cdot f_{2,N} \cdot f_{3,N} \cdot f_{h,p} \cdot f_{re,N}$
- Concrete cone resistance: $N_{Rd,c} = N_{Rd,c}^0 \cdot f_B \cdot f_{1,N} \cdot f_{2,N} \cdot f_{3,N} \cdot f_{h,N} \cdot f_{re,N}$
- Concrete splitting resistance (only non-cracked concrete):
 $N_{Rd,sp} = N_{Rd,c}^0 \cdot f_B \cdot f_{1,sp} \cdot f_{2,sp} \cdot f_{3,sp} \cdot f_{h,N} \cdot f_{re,N}$

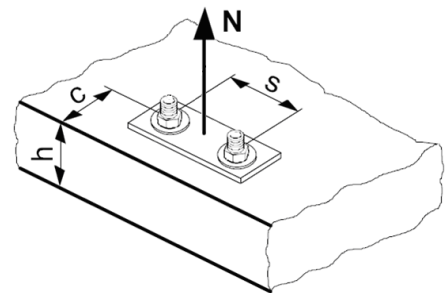

Basic design tensile resistance

Design steel resistance $N_{Rd,s}$

Anchor size			M8x90	M10x110	M12x125	M16x170	M20x205
$N_{Rd,s}$	HIS-N	[kN]	17,5	30,7	44,7	80,3	74,1
	HIS-RN	[kN]	13,9	21,9	31,6	58,8	69,2

Design combined pull-out and concrete cone resistance

$$N_{Rd,p} = N_{Rd,p}^0 \cdot f_{B,p} \cdot f_{1,N} \cdot f_{2,N} \cdot f_{3,N} \cdot f_{h,p} \cdot f_{re,N}$$

Anchor size			M8x90	M10x110	M12x125	M16x170	M20x205
Embedment depth	h_{ef} [mm]		90	110	125	170	205
$N_{Rd,p}^0$	Temperature range I	[kN]	23,3	26,7	40,0	63,9	77,8
$N_{Rd,p}^0$	Temperature range II	[kN]	13,3	20,0	26,7	41,7	52,8
$N_{Rd,p}^0$	Temperature range III	[kN]	10,7	13,3	20,0	27,8	33,3

Design concrete cone resistance $N_{Rd,c} = N_{Rd,c}^0 \cdot f_B \cdot f_{1,N} \cdot f_{2,N} \cdot f_{3,N} \cdot f_{h,N} \cdot f_{re,N}$

Design splitting resistance $N_{Rd,sp} = N_{Rd,c}^0 \cdot f_B \cdot f_{1,sp} \cdot f_{2,sp} \cdot f_{3,sp} \cdot f_{h,N} \cdot f_{re,N}$

Anchor size			M8	M10	M12	M16	M20
$N_{Rd,c}^0$		[kN]	28,7	38,8	47,1	62,2	82,3

Influencing factors

Influence of concrete strength on combined pull-out and concrete cone resistance

Concrete strength designation (ENV 206)	C 20/25	C 25/30	C 30/37	C 35/45	C 40/50	C 45/55	C 50/60
$f_{B,p} = (f_{ck,cube}/25N/mm^2)^{0,15}$ ^{a)}	1,00	1,03	1,06	1,09	1,11	1,13	1,14

a) $f_{ck,cube}$ = concrete compressive strength, measured on cubes with 150 mm side length

Influence of embedment depth on combined pull-out and concrete cone resistance

$f_{h,p} = 1$

Influence of concrete strength on concrete cone resistance

Concrete strength designation (ENV 206)	C 20/25	C 25/30	C 30/37	C 35/45	C 40/50	C 45/55	C 50/60
$f_B = (f_{ck,cube}/25N/mm^2)^{0,5}$ ^{a)}	1	1,1	1,22	1,34	1,41	1,48	1,55

a) $f_{ck,cube}$ = concrete compressive strength, measured on cubes with 150 mm side length

Influence of edge distance ^{a)}

$c/c_{cr,N}$	0,1	0,2	0,3	0,4	0,5	0,6	0,7	0,8	0,9	1
$c/c_{cr,sp}$										
$f_{1,N} = 0,7 + 0,3 \cdot c/c_{cr,N} \leq 1$	0,73	0,76	0,79	0,82	0,85	0,88	0,91	0,94	0,97	1
$f_{1,sp} = 0,7 + 0,3 \cdot c/c_{cr,sp} \leq 1$										
$f_{2,N} = 0,5 \cdot (1 + c/c_{cr,N}) \leq 1$	0,55	0,60	0,65	0,70	0,75	0,80	0,85	0,90	0,95	1
$f_{2,sp} = 0,5 \cdot (1 + c/c_{cr,sp}) \leq 1$										

a) The edge distance shall not be smaller than the minimum edge distance c_{min} . These influencing factors must be considered for every edge distance smaller than the critical edge distance.

Influence of anchor spacing ^{a)}

$s/s_{cr,N}$	0,1	0,2	0,3	0,4	0,5	0,6	0,7	0,8	0,9	1
$s/s_{cr,sp}$										
$f_{3,N} = 0,5 \cdot (1 + s/s_{cr,N}) \leq 1$	0,55	0,60	0,65	0,70	0,75	0,80	0,85	0,90	0,95	1
$f_{3,sp} = 0,5 \cdot (1 + s/s_{cr,sp}) \leq 1$										

a) The anchor spacing shall not be smaller than the minimum anchor spacing s_{min} . This influencing factor must be considered for every anchor spacing.

Influence of embedment depth on concrete cone resistance

$f_{h,N} = 1$

Influence of reinforcement

h_{ef} [mm]	40	50	60	70	80	90	≥ 100
$f_{re,N} = 0,5 + h_{ef}/200mm \leq 1$	0,7 ^{a)}	0,75 ^{a)}	0,8 ^{a)}	0,85 ^{a)}	0,9 ^{a)}	0,95 ^{a)}	1

a) This factor applies only for dense reinforcement. If in the area of anchorage there is reinforcement with a spacing ≥ 150 mm (any diameter) or with a diameter ≤ 10 mm and a spacing ≥ 100 mm, then a factor $f_{re,N} = 1$ may be applied.

Shear loading

The design shear resistance is the lower value of

- Steel resistance: $V_{Rd,s}$
- Concrete pryout resistance: $V_{Rd,cp} = k \cdot \text{lower value of } N_{Rd,p} \text{ and } N_{Rd,c}$
- Concrete edge resistance: $V_{Rd,c} = V_{Rd,c}^0 \cdot f_B \cdot f_{\beta} \cdot f_h \cdot f_4 \cdot f_{hef} \cdot f_c$

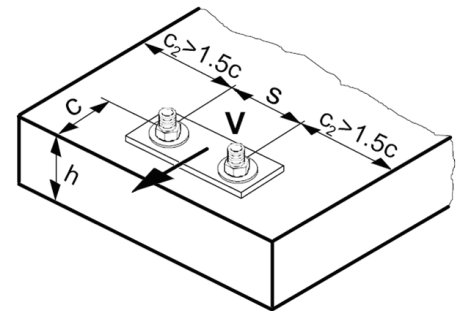

Basic design shear resistance

Design steel resistance $V_{Rd,s}$

Anchor size		M8x90	M10x110	M12x125	M16x170	M20x205
$V_{Rd,s}$	HIS-N [kN]	10,4	18,4	26,0	39,3	36,7
	HIS-RN [kN]	8,3	12,8	19,2	35,3	41,5

Design concrete pryout resistance $V_{Rd,cp}$ = lower value^{a)} of $k \cdot N_{Rd,p}$ and $k \cdot N_{Rd,c}$

$$k = 2 \text{ for } h_{ef} \geq 60 \text{ mm}$$

- a) $N_{Rd,p}$: Design combined pull-out and concrete cone resistance
 $N_{Rd,c}$: Design concrete cone resistance

Design concrete edge resistance $V_{Rd,c} = V_{Rd,c}^0 \cdot f_B \cdot f_{\beta} \cdot f_h \cdot f_4 \cdot f_{hef} \cdot f_c$

Anchor size	M8	M10	M12	M16	M20
Non-cracked concrete					
$V_{Rd,c}^0$ [kN]	12,4	19,6	28,2	40,2	46,2

Influencing factors

Influence of concrete strength

Concrete strength designation (ENV 206)	C 20/25	C 25/30	C 30/37	C 35/45	C 40/50	C 45/55	C 50/60
$f_B = (f_{ck,cube}/25N/mm^2)^{1/2 \text{ a)}$	1	1,1	1,22	1,34	1,41	1,48	1,55

- a) $f_{ck,cube}$ = concrete compressive strength, measured on cubes with 150 mm side length

Influence of angle between load applied and the direction perpendicular to the free edge

Angle β	0°	10°	20°	30°	40°	50°	60°	70°	80°	≥ 90°
$f_{\beta} = \frac{1}{\sqrt{(\cos \alpha_V)^2 + \left(\frac{\sin \alpha_V}{2,5}\right)^2}}$	1	1,01	1,05	1,13	1,24	1,40	1,64	1,97	2,32	2,50

Influence of base material thickness

h/c	0,15	0,3	0,45	0,6	0,75	0,9	1,05	1,2	1,35	≥ 1,5
$f_h = \{h/(1,5 \cdot c)\}^{1/2} \leq 1$	0,32	0,45	0,55	0,63	0,71	0,77	0,84	0,89	0,95	1,00

Influence of anchor spacing and edge distance ^{a)} for concrete edge resistance: f_4
 $f_4 = (c/h_{ef})^{1,5} \cdot (1 + s / [3 \cdot c]) \cdot 0,5$

c/h _{ef}	Single anchor	Group of two anchors s/h _{ef}														
		0,75	1,50	2,25	3,00	3,75	4,50	5,25	6,00	6,75	7,50	8,25	9,00	9,75	10,50	11,25
0,50	0,35	0,27	0,35	0,35	0,35	0,35	0,35	0,35	0,35	0,35	0,35	0,35	0,35	0,35	0,35	0,35
0,75	0,65	0,43	0,54	0,65	0,65	0,65	0,65	0,65	0,65	0,65	0,65	0,65	0,65	0,65	0,65	0,65
1,00	1,00	0,63	0,75	0,88	1,00	1,00	1,00	1,00	1,00	1,00	1,00	1,00	1,00	1,00	1,00	1,00
1,25	1,40	0,84	0,98	1,12	1,26	1,40	1,40	1,40	1,40	1,40	1,40	1,40	1,40	1,40	1,40	1,40
1,50	1,84	1,07	1,22	1,38	1,53	1,68	1,84	1,84	1,84	1,84	1,84	1,84	1,84	1,84	1,84	1,84
1,75	2,32	1,32	1,49	1,65	1,82	1,98	2,15	2,32	2,32	2,32	2,32	2,32	2,32	2,32	2,32	2,32
2,00	2,83	1,59	1,77	1,94	2,12	2,30	2,47	2,65	2,83	2,83	2,83	2,83	2,83	2,83	2,83	2,83
2,25	3,38	1,88	2,06	2,25	2,44	2,63	2,81	3,00	3,19	3,38	3,38	3,38	3,38	3,38	3,38	3,38
2,50	3,95	2,17	2,37	2,57	2,77	2,96	3,16	3,36	3,56	3,76	3,95	3,95	3,95	3,95	3,95	3,95
2,75	4,56	2,49	2,69	2,90	3,11	3,32	3,52	3,73	3,94	4,15	4,35	4,56	4,56	4,56	4,56	4,56
3,00	5,20	2,81	3,03	3,25	3,46	3,68	3,90	4,11	4,33	4,55	4,76	4,98	5,20	5,20	5,20	5,20
3,25	5,86	3,15	3,38	3,61	3,83	4,06	4,28	4,51	4,73	4,96	5,18	5,41	5,63	5,86	5,86	5,86
3,50	6,55	3,51	3,74	3,98	4,21	4,44	4,68	4,91	5,14	5,38	5,61	5,85	6,08	6,31	6,55	6,55
3,75	7,26	3,87	4,12	4,36	4,60	4,84	5,08	5,33	5,57	5,81	6,05	6,29	6,54	6,78	7,02	7,26
4,00	8,00	4,25	4,50	4,75	5,00	5,25	5,50	5,75	6,00	6,25	6,50	6,75	7,00	7,25	7,50	7,75
4,25	8,76	4,64	4,90	5,15	5,41	5,67	5,93	6,18	6,44	6,70	6,96	7,22	7,47	7,73	7,99	8,25
4,50	9,55	5,04	5,30	5,57	5,83	6,10	6,36	6,63	6,89	7,16	7,42	7,69	7,95	8,22	8,49	8,75
4,75	10,35	5,45	5,72	5,99	6,27	6,54	6,81	7,08	7,36	7,63	7,90	8,17	8,45	8,72	8,99	9,26
5,00	11,18	5,87	6,15	6,43	6,71	6,99	7,27	7,55	7,83	8,11	8,39	8,66	8,94	9,22	9,50	9,78
5,25	12,03	6,30	6,59	6,87	7,16	7,45	7,73	8,02	8,31	8,59	8,88	9,17	9,45	9,74	10,02	10,31
5,50	12,90	6,74	7,04	7,33	7,62	7,92	8,21	8,50	8,79	9,09	9,38	9,67	9,97	10,26	10,55	10,85

a) The anchor spacing and the edge distance shall not be smaller than the minimum anchor spacing s_{min} and the minimum edge distance c_{min} .

Influence of embedment depth

Anchor size	M8	M10	M12	M16	M20
$f_{hef} =$	1,38	1,21	1,04	1,22	1,45

Influence of edge distance ^{a)}

c/d	4	6	8	10	15	20	30	40
$f_c = (d / c)^{0,19}$	0,77	0,71	0,67	0,65	0,60	0,57	0,52	0,50

a) The edge distance shall not be smaller than the minimum edge distance c_{min} .

Combined tension and shear loading

For combined tension and shear loading see section "Anchor Design".

Precalculated values – design resistance values

All data applies to:

- non-cracked concrete C 20/25 – $f_{ck,cube} = 25 \text{ N/mm}^2$
- temperature range I (see Service temperature range)
- minimum thickness of base material
- no effects of dense reinforcement

Recommended loads can be calculated by dividing the design resistance by an overall partial safety factor for action $\gamma = 1,4$. The partial safety factors for action depend on the type of loading and shall be taken from national regulations.

Design resistance: non-cracked- concrete C 20/25

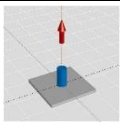
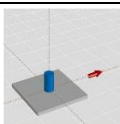
Anchor size		M8x90	M10x110	M12x125	M16x170	M20x205
Embedment depth	h_{ef} [mm]	90	110	125	170	205
Base material thickness	$h = h_{min}$ [mm]	120	150	170	230	270
	Tensile N_{Rd}: single anchor, no edge effects					
	HIS-N [kN]	17,5	26,7	40,0	62,2	74,1
	HIS-RN [kN]	13,9	21,9	31,6	58,8	69,2
	Shear V_{Rd}: single anchor, no edge effects, without lever arm					
	HIS-N [kN]	10,4	18,4	26,0	39,3	36,7
	HIS-RN [kN]	8,3	12,8	19,2	35,3	41,5

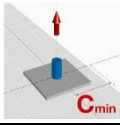
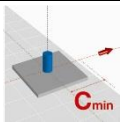

Design resistance: non-cracked- concrete C 20/25

Anchor size		M8x90	M10x110	M12x125	M16x170	M20x205
Embedment depth	h_{ef} [mm]	90	110	125	170	205
Base material thickness	$h = h_{min}$ [mm]	120	150	170	230	270
Edge distance	$c = c_{min}$ [mm]	40	45	55	65	90
	Tensile N_{Rd}: single single anchor, min. edge distance ($c = c_{min}$)					
	HIS-N [kN]	11,9	13,4	20,4	27,5	37,4
	HIS-RN [kN]	11,9	13,4	20,4	27,5	37,4
	Shear V_{Rd}: single anchor, min. edge distance ($c = c_{min}$), without lever arm					
	HIS-N [kN]	4,2	5,5	7,6	10,8	17,2
	HIS-RN [kN]	4,2	5,5	7,6	10,8	17,2

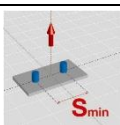
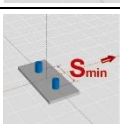
Design resistance: non-cracked- concrete C 20/25

Anchor size		M8x90	M10x110	M12x125	M16x170	M20x205
Embedment depth	h_{ef} [mm]	90	110	125	170	205
Base material thickness	$h = h_{min}$ [mm]	120	150	170	230	270
Spacing	$s = s_{min}$ [mm]	40	45	55	65	90
	Tensile N_{Rd}: double anchor, no edge effects, min. spacing ($s = s_{min}$)					
	HIS-N [kN]	14,3	16,9	24,2	33,8	45,2
	HIS-RN [kN]	13,9	16,9	24,2	33,8	45,2
	Shear V_{Rd}: double anchor, no edge effects, min. spacing ($s = s_{min}$), without lever arm					
	HIS-N [kN]	10,4	18,4	26,0	39,3	36,7
	HIS-RN [kN]	8,3	12,8	19,2	35,3	41,5

Hilti HIT-HY 110 mortar with rebar (as anchor)

Injection mortar system		Benefits
	Hilti HIT-HY 110 500 ml foil pack (also available as 330 ml foil pack)	<ul style="list-style-type: none"> - suitable for non-cracked concrete C 20/25 to C 50/60 - suitable for dry and water saturated concrete - small edge distance and anchor spacing possible - large diameter applications - in service temperature range up to 120°C short term/72°C long term - manual cleaning for drill hole sizes ≤ 18 mm and embedment depth $h_{ef} \leq 10d$ - embedment depth range $\varnothing 8$: 60 to 160 mm $\varnothing 25$: 120 to 500 mm
	Static mixer	
	rebar BSt 500 S	



Concrete

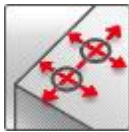

Small edge distance and spacing

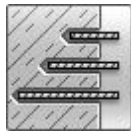

Variable embedment depth



European Technical Approval



CE conformity

Approvals / certificates

Description	Authority / Laboratory	No. / date of issue
European Technical Approval ^{a)}	DIBt, Berlin	ETA-08/0341 / 2013-03-18

a) All data given in this section according ETA-08/0341 issue 2013-03-18.

Basic loading data (for a single anchor)

All data in this section applies to

- Correct setting (See setting instruction)
- No edge distance and spacing influence
- Steel failure
- Base material thickness, as specified in the table
- One typical embedment depth, as specified in the table
- Anchor material: rebar BSt 500 S
- Concrete C 20/25, $f_{ck,cube} = 25$ N/mm²
- Temperate range I
(min. base material temperature -40°C, max. long term/short term base material temperature: +24°C/40°C)
- Installation temperature range -5°C to +40°C

For details see Simplified design method

Embedment depth ^{a)} and base material thickness for the basic loading data. Mean ultimate resistance, characteristic resistance, design resistance, recommended loads.

Anchor size	Ø8	Ø10	Ø12	Ø14	Ø16	Ø20	Ø25
Embedment depth $h_{ef} = h_{ef,typ}$ ^{b)} [mm]	80	90	110	125	170	210	240
Base material thickness h [mm]	110	120	140	165	220	270	300

a) The allowed range of embedment depth is shown in the setting details. The corresponding load values can be calculated according to the simplified design method.

b) $h_{ef,typ}$: Typical embedment depth

Mean ultimate resistance: non-cracked concrete C 20/25 , anchor BSt 500 S

Anchor size	Ø8	Ø10	Ø12	Ø14	Ø16	Ø20	Ø25
Tensile $N_{Ru,m}$ BSt 500 S [kN]	22,8	32,0	47,0	55,0	72,9	106,8	164,9
Shear $V_{Ru,m}$ BSt 500 S [kN]	14,7	23,1	32,6	44,1	57,8	90,3	141,8

Characteristic resistance: non-cracked concrete C 20/25 , anchor BSt 500 S

Anchor size	Ø8	Ø10	Ø12	Ø14	Ø16	Ø20	Ø25
Tensile N_{Rk} BSt 500 S [kN]	17,1	24,0	35,2	41,2	54,7	80,1	123,7
Shear V_{Rk} BSt 500 S [kN]	14,0	22,0	31,0	42,0	55,0	86,0	135,0

Design resistance: non-cracked concrete C 20/25 , anchor BSt 500 S

Anchor size	Ø8	Ø10	Ø12	Ø14	Ø16	Ø20	Ø25
Tensile N_{Rd} BSt 500 S [kN]	11,4	13,4	19,6	19,6	26,0	38,1	58,9
Shear V_{Rd} BSt 500 S [kN]	9,3	14,7	20,7	28,0	36,7	57,3	90,0

Recommended loads ^{a)}: non-cracked concrete C 20/25 , anchor BSt 500 S

Anchor size	Ø8	Ø10	Ø12	Ø14	Ø16	Ø20	Ø25
Tensile N_{rec} BSt 500 S [kN]	8,1	9,5	14,0	14,0	18,6	27,2	42,1
Shear V_{rec} BSt 500 S [kN]	6,7	10,5	14,8	20,0	26,2	41,0	64,3

a) With overall partial safety factor for action $\gamma = 1,4$. The partial safety factors for action depend on the type of loading and shall be taken from national regulations.

Service temperature range

Hilti HIT-HY 110 injection mortar may be applied in the temperature ranges given below. An elevated base material temperature may lead to a reduction of the design bond resistance.

Temperature range	Base material temperature	Maximum long term base material temperature	Maximum short term base material temperature
Temperature range I	-40 °C to +40 °C	+24 °C	+40 °C
Temperature range II	-40 °C to +80 °C	+50 °C	+80 °C
Temperature range III	-40 °C to +120 °C	+72 °C	+120 °C

Max short term base material temperature

Short-term elevated base material temperatures are those that occur over brief intervals, e.g. as a result of diurnal cycling.

Max long term base material temperature

Long-term elevated base material temperatures are roughly constant over significant periods of time.

Materials

Mechanical properties of rebar BSt 500S

Anchor size			Ø8	Ø10	Ø12	Ø14	Ø16	Ø20	Ø25
Nominal tensile strength f_{uk}	BSt 500 S	[N/mm ²]	550						
Yield strength f_{yk}	BSt 500 S	[N/mm ²]	500						
Stressed cross-section A_s	BSt 500 S	[mm ²]	50,3	78,5	113,1	153,9	201,1	314,2	490,9
Moment of resistance W	BSt 500 S	[mm ³]	50,3	98,2	169,6	269,4	402,1	785,4	1534

Material quality

Part	Material
rebar BSt 500 S	Mechanical properties according to DIN 488-1:1984 Geometry according to DIN 488-21:1986

Anchor dimensions

Anchor size	Ø8	Ø10	Ø12	Ø14	Ø16	Ø20	Ø25
rebar BSt 500 S	rebar are available in variable length						

Setting

installation equipment

Anchor size	Ø8	Ø10	Ø12	Ø14	Ø16	Ø20	Ø25
Rotary hammer	TE 2 – TE 30					TE 40 – TE 70	
Other tools	compressed air gun or blow out pump, set of cleaning brushes, dispenser						

Setting instruction

Dry and water-saturated concrete, hammer drilling

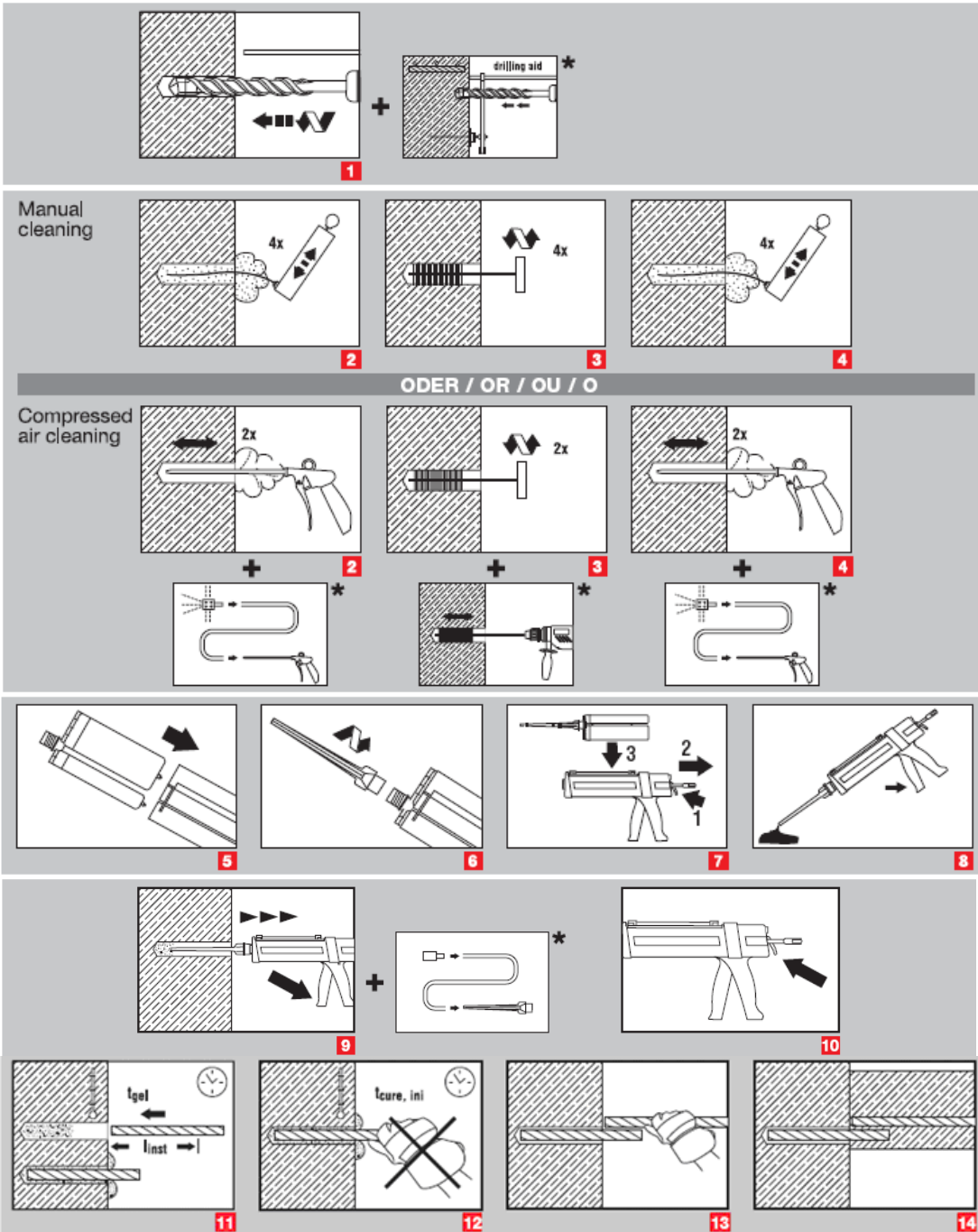
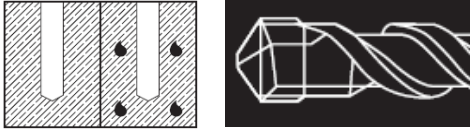

a)

b)

a) Note: Manual cleaning for drill hole sizes $d_0 \leq 18\text{mm}$ and embedment depth $h_{ef} \leq 10 d$ only!
Compressed air cleaning for all bore hole diameters and all bore hole depth

b) Note: Extension and piston plug needed for overhead installation and/or embedment depth $> 250\text{mm}$!

For detailed information on installation see instruction for use given with the package of the product.

Working time, Curing time

Temperature of the base material T_{BM}	Working time t_{gel}	Curing time $t_{cure}^{a)}$
-5 °C to -1 °C	90 min	9 h
0 °C to 4 °C	45 min	4,5 h
5 °C to 9 °C	20 min	2 h
10 °C to 19 °C	6 min	90 min
20 °C to 29 °C	4 min	50 min
30 °C to 40 °C	2 min	40 min

a) The curing time data are valid for dry anchorage base only. For water saturated anchorage bases the curing times must be doubled.

Setting details

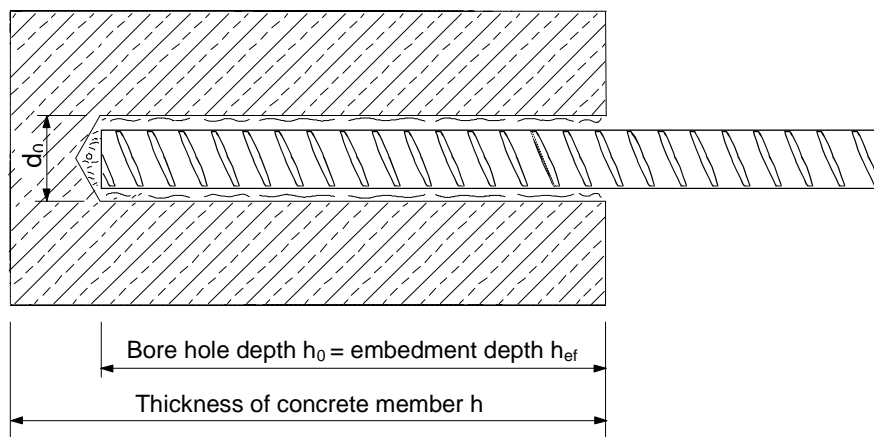

Anchor size			Ø8	Ø10	Ø12	Ø14	Ø16	Ø20	Ø25	
Nominal diameter of drill bit	d_0	[mm]	12	14	16	18	20	25	32	
Effective embedment and drill hole depth range ^{a)} for rebar BSt 500 S	$h_{ef,min}$	[mm]	60	60	70	75	80	90	100	
	$h_{ef,max}$	[mm]	160	200	240	280	320	400	500	
Minimum base material thickness	h_{min}	[mm]	$h_{ef} + 30 \text{ mm}$ $\geq 100 \text{ mm}$			$h_{ef} + 2 d_0$				
Minimum spacing	s_{min}	[mm]	40	50	60	70	80	100	150	
Minimum edge distance	c_{min}	[mm]	40	50	60	80	100	120	150	
Critical spacing for splitting failure	$s_{cr,sp}$	[mm]	$2 c_{cr,sp}$							
Critical edge distance for splitting failure ^{b)}	$c_{cr,sp}$	[mm]	$1,0 \cdot h_{ef}$ for $h / h_{ef} \geq 2,0$							
			$4,6 h_{ef} - 1,8 h$ for $2,0 > h / h_{ef} > 1,3$							
			$2,26 h_{ef}$ for $h / h_{ef} \leq 1,3$							
Critical spacing for concrete cone failure	$s_{cr,N}$	[mm]	$2 c_{cr,N}$							
Critical edge distance for concrete cone failure ^{c)}	$c_{cr,N}$	[mm]	$1,5 h_{ef}$							

For spacing (or edge distance) smaller than critical spacing (or critical edge distance) the design loads have to be reduced.

- a) Embedment depth range: $h_{ef,min} \leq h_{ef} \leq h_{ef,max}$
- b) h : base material thickness ($h \geq h_{min}$), h_{ef} : embedment depth
- c) The critical edge distance for concrete cone failure depends on the embedment depth h_{ef} and the design bond resistance. The simplified formula given in this table is on the safe side.

Simplified design method

Simplified version of the design method according ETAG 001, TR 029.

- Influence of concrete strength
- Influence of edge distance
- Influence of spacing
- Valid for a group of two anchors. (The method may also be applied for anchor groups with more than two anchors or more than one edge distance. The influencing factors must then be considered for each edge distance and spacing. The calculated design loads are then on the safe side: They will be lower than the exact values according ETAG 001, TR 029. To avoid this, it is recommended to use the anchor design software PROFIS anchor)

The design method is based on the following simplification:

- No different loads are acting on individual anchors (no eccentricity)

The values are valid for one anchor.

For more complex fastening applications please use the anchor design software PROFIS Anchor.

Tension loading

The design tensile resistance is the lower value of

- Steel resistance: $N_{Rd,s}$
- Combined pull-out and concrete cone resistance:
 $N_{Rd,p} = N_{Rd,p}^0 \cdot f_{B,p} \cdot f_{1,N} \cdot f_{2,N} \cdot f_{3,N} \cdot f_{h,p} \cdot f_{re,N}$
- Concrete cone resistance: $N_{Rd,c} = N_{Rd,c}^0 \cdot f_B \cdot f_{1,N} \cdot f_{2,N} \cdot f_{3,N} \cdot f_{h,N} \cdot f_{re,N}$
- Concrete splitting resistance (only non-cracked concrete):
 $N_{Rd,sp} = N_{Rd,c}^0 \cdot f_B \cdot f_{1,sp} \cdot f_{2,sp} \cdot f_{3,sp} \cdot f_{h,N} \cdot f_{re,N}$

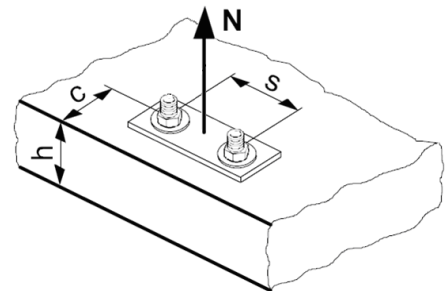

Basic design tensile resistance

Design steel resistance $N_{Rd,s}$

Anchor size		Ø8	Ø10	Ø12	Ø14	Ø16	Ø20	Ø25
$N_{Rd,s}$ BSt 500 S	[kN]	20,0	30,7	44,3	60,7	79,3	123,6	192,9

Design combined pull-out and concrete cone resistance

$$N_{Rd,p} = N_{Rd,p}^0 \cdot f_{B,p} \cdot f_{1,N} \cdot f_{2,N} \cdot f_{3,N} \cdot f_{h,p} \cdot f_{re,N}$$

Anchor size		Ø8	Ø10	Ø12	Ø14	Ø16	Ø20	Ø25
Embedment depth $h_{ef} =$ Typical embedment depth $h_{ef,typ}$	[mm]	80	90	110	125	145	170	210
$N_{Rd,p}^0$ Temperature range I	[kN]	11,4	13,4	19,6	19,6	26,0	38,1	58,9
$N_{Rd,p}^0$ Temperature range II	[kN]	8,0	9,4	13,8	13,1	17,4	25,4	39,3
$N_{Rd,p}^0$ Temperature range III	[kN]	6,7	7,9	11,5	11,8	15,6	22,9	35,3

$$\text{Design concrete cone resistance } N_{Rd,c} = N_{Rd,c}^0 \cdot f_B \cdot f_{1,N} \cdot f_{2,N} \cdot f_{3,N} \cdot f_{h,N} \cdot f_{re,N}$$

$$\text{Design splitting resistance } N_{Rd,sp} = N_{Rd,c}^0 \cdot f_B \cdot f_{1,sp} \cdot f_{2,sp} \cdot f_{3,sp} \cdot f_{h,N} \cdot f_{re,N}$$

Anchor size		Ø8	Ø10	Ø12	Ø14	Ø16	Ø20	Ø25
$N_{Rd,c}^0$	[kN]	24,1	24,0	32,4	33,6	42,0	53,3	73,2

Influencing factors

Influence of concrete strength on combined pull-out and concrete cone resistance

Concrete strength designation (ENV 206)	C 20/25	C 25/30	C 30/37	C 35/45	C 40/50	C 45/55	C 50/60
$f_{B,p} = (f_{ck,cube}/25N/mm^2)^{0,15}$ a)	1,00	1,03	1,06	1,09	1,11	1,13	1,14

a) $f_{ck,cube}$ = concrete compressive strength, measured on cubes with 150 mm side length

Influence of embedment depth on combined pull-out and concrete cone resistance

$f_{h,p} = h_{ef}/h_{ef,typ}$

Influence of concrete strength on concrete cone resistance

Concrete strength designation (ENV 206)	C 20/25	C 25/30	C 30/37	C 35/45	C 40/50	C 45/55	C 50/60
$f_B = (f_{ck,cube}/25N/mm^2)^{0,5}$ a)	1	1,1	1,22	1,34	1,41	1,48	1,55

a) $f_{ck,cube}$ = concrete compressive strength, measured on cubes with 150 mm side length

Influence of edge distance a)

$c/c_{cr,N}$	0,1	0,2	0,3	0,4	0,5	0,6	0,7	0,8	0,9	1
$c/c_{cr,sp}$										
$f_{1,N} = 0,7 + 0,3 \cdot c/c_{cr,N} \leq 1$	0,73	0,76	0,79	0,82	0,85	0,88	0,91	0,94	0,97	1
$f_{1,sp} = 0,7 + 0,3 \cdot c/c_{cr,sp} \leq 1$										
$f_{2,N} = 0,5 \cdot (1 + c/c_{cr,N}) \leq 1$	0,55	0,60	0,65	0,70	0,75	0,80	0,85	0,90	0,95	1
$f_{2,sp} = 0,5 \cdot (1 + c/c_{cr,sp}) \leq 1$										

a) The edge distance shall not be smaller than the minimum edge distance c_{min} . These influencing factors must be considered for every edge distance smaller than the critical edge distance.

Influence of anchor spacing a)

$s/s_{cr,N}$	0,1	0,2	0,3	0,4	0,5	0,6	0,7	0,8	0,9	1
$s/s_{cr,sp}$										
$f_{3,N} = 0,5 \cdot (1 + s/s_{cr,N}) \leq 1$	0,55	0,60	0,65	0,70	0,75	0,80	0,85	0,90	0,95	1
$f_{3,sp} = 0,5 \cdot (1 + s/s_{cr,sp}) \leq 1$										

a) The anchor spacing shall not be smaller than the minimum anchor spacing s_{min} . This influencing factor must be considered for every anchor spacing.

Influence of embedment depth on concrete cone resistance

$f_{h,N} = (h_{ef}/h_{ef,typ})^{1,5}$

Influence of reinforcement

h_{ef} [mm]	40	50	60	70	80	90	≥ 100
$f_{re,N} = 0,5 + h_{ef}/200mm \leq 1$	0,7 ^{a)}	0,75 ^{a)}	0,8 ^{a)}	0,85 ^{a)}	0,9 ^{a)}	0,95 ^{a)}	1

a) This factor applies only for dense reinforcement. If in the area of anchorage there is reinforcement with a spacing ≥ 150 mm (any diameter) or with a diameter ≤ 10 mm and a spacing ≥ 100 mm, then a factor $f_{re,N} = 1$ may be applied.

Shear loading

The design shear resistance is the lower value of

- Steel resistance: $V_{Rd,s}$
- Concrete pryout resistance: $V_{Rd,cp} = k \cdot \text{lower value of } N_{Rd,p} \text{ and } N_{Rd,c}$
- Concrete edge resistance: $V_{Rd,c} = V_{Rd,c}^0 \cdot f_B \cdot f_{\beta} \cdot f_h \cdot f_4 \cdot f_{hef} \cdot f_c$

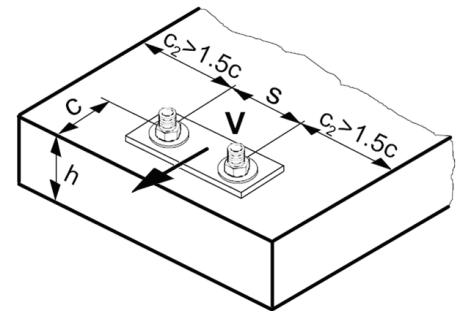

Basic design shear resistance

Design steel resistance $V_{Rd,s}$

Anchor size	Ø8	Ø10	Ø12	Ø14	Ø16	Ø20	Ø25
$V_{Rd,s}$ Rebar BSt 500 S [kN]	9,3	14,7	20,7	28,0	36,7	57,3	90,0

Design concrete pryout resistance $V_{Rd,cp} = \text{lower value}^a)$ of $k \cdot N_{Rd,p}$ and $k \cdot N_{Rd,c}$

$$k = 2 \text{ for } h_{ef} \geq 60 \text{ mm}$$

- a) $N_{Rd,p}$: Design combined pull-out and concrete cone resistance
 $N_{Rd,c}$: Design concrete cone resistance

Design concrete edge resistance $V_{Rd,c} = V_{Rd,c}^0 \cdot f_B \cdot f_{\beta} \cdot f_h \cdot f_4 \cdot f_{hef} \cdot f_c$

Anchor size	Ø8	Ø10	Ø12	Ø14	Ø16	Ø20	Ø25
Non-cracked concrete							
$V_{Rd,c}^0$ [kN]	5,9	8,6	11,6	15,0	18,7	27,0	39,2

Influencing factors

Influence of concrete strength

Concrete strength designation (ENV 206)	C 20/25	C 25/30	C 30/37	C 35/45	C 40/50	C 45/55	C 50/60
$f_B = (f_{ck,cube}/25N/mm^2)^{1/2}$ a)	1	1,1	1,22	1,34	1,41	1,48	1,55

- a) $f_{ck,cube}$ = concrete compressive strength, measured on cubes with 150 mm side length

Influence of angle between load applied and the direction perpendicular to the free edge

Angle β	0°	10°	20°	30°	40°	50°	60°	70°	80°	≥ 90°
$f_{\beta} = \frac{1}{\sqrt{(\cos \alpha_V)^2 + \left(\frac{\sin \alpha_V}{2,5}\right)^2}}$	1	1,01	1,05	1,13	1,24	1,40	1,64	1,97	2,32	2,50

Influence of base material thickness

h/c	0,15	0,3	0,45	0,6	0,75	0,9	1,05	1,2	1,35	≥ 1,5
$f_h = \{h/(1,5 \cdot c)\}^{1/2} \leq 1$	0,32	0,45	0,55	0,63	0,71	0,77	0,84	0,89	0,95	1,00

Influence of anchor spacing and edge distance ^{a)} for concrete edge resistance: f_4
 $f_4 = (c/h_{ef})^{1,5} \cdot (1 + s / [3 \cdot c]) \cdot 0,5$

c/h _{ef}	Single anchor	Group of two anchors s/h _{ef}														
		0,75	1,50	2,25	3,00	3,75	4,50	5,25	6,00	6,75	7,50	8,25	9,00	9,75	10,50	11,25
0,50	0,35	0,27	0,35	0,35	0,35	0,35	0,35	0,35	0,35	0,35	0,35	0,35	0,35	0,35	0,35	0,35
0,75	0,65	0,43	0,54	0,65	0,65	0,65	0,65	0,65	0,65	0,65	0,65	0,65	0,65	0,65	0,65	0,65
1,00	1,00	0,63	0,75	0,88	1,00	1,00	1,00	1,00	1,00	1,00	1,00	1,00	1,00	1,00	1,00	1,00
1,25	1,40	0,84	0,98	1,12	1,26	1,40	1,40	1,40	1,40	1,40	1,40	1,40	1,40	1,40	1,40	1,40
1,50	1,84	1,07	1,22	1,38	1,53	1,68	1,84	1,84	1,84	1,84	1,84	1,84	1,84	1,84	1,84	1,84
1,75	2,32	1,32	1,49	1,65	1,82	1,98	2,15	2,32	2,32	2,32	2,32	2,32	2,32	2,32	2,32	2,32
2,00	2,83	1,59	1,77	1,94	2,12	2,30	2,47	2,65	2,83	2,83	2,83	2,83	2,83	2,83	2,83	2,83
2,25	3,38	1,88	2,06	2,25	2,44	2,63	2,81	3,00	3,19	3,38	3,38	3,38	3,38	3,38	3,38	3,38
2,50	3,95	2,17	2,37	2,57	2,77	2,96	3,16	3,36	3,56	3,76	3,95	3,95	3,95	3,95	3,95	3,95
2,75	4,56	2,49	2,69	2,90	3,11	3,32	3,52	3,73	3,94	4,15	4,35	4,56	4,56	4,56	4,56	4,56
3,00	5,20	2,81	3,03	3,25	3,46	3,68	3,90	4,11	4,33	4,55	4,76	4,98	5,20	5,20	5,20	5,20
3,25	5,86	3,15	3,38	3,61	3,83	4,06	4,28	4,51	4,73	4,96	5,18	5,41	5,63	5,86	5,86	5,86
3,50	6,55	3,51	3,74	3,98	4,21	4,44	4,68	4,91	5,14	5,38	5,61	5,85	6,08	6,31	6,55	6,55
3,75	7,26	3,87	4,12	4,36	4,60	4,84	5,08	5,33	5,57	5,81	6,05	6,29	6,54	6,78	7,02	7,26
4,00	8,00	4,25	4,50	4,75	5,00	5,25	5,50	5,75	6,00	6,25	6,50	6,75	7,00	7,25	7,50	7,75
4,25	8,76	4,64	4,90	5,15	5,41	5,67	5,93	6,18	6,44	6,70	6,96	7,22	7,47	7,73	7,99	8,25
4,50	9,55	5,04	5,30	5,57	5,83	6,10	6,36	6,63	6,89	7,16	7,42	7,69	7,95	8,22	8,49	8,75
4,75	10,35	5,45	5,72	5,99	6,27	6,54	6,81	7,08	7,36	7,63	7,90	8,17	8,45	8,72	8,99	9,26
5,00	11,18	5,87	6,15	6,43	6,71	6,99	7,27	7,55	7,83	8,11	8,39	8,66	8,94	9,22	9,50	9,78
5,25	12,03	6,30	6,59	6,87	7,16	7,45	7,73	8,02	8,31	8,59	8,88	9,17	9,45	9,74	10,02	10,31
5,50	12,90	6,74	7,04	7,33	7,62	7,92	8,21	8,50	8,79	9,09	9,38	9,67	9,97	10,26	10,55	10,85

a) The anchor spacing and the edge distance shall not be smaller than the minimum anchor spacing s_{min} and the minimum edge distance c_{min} .

Influence of embedment depth

h _{ef} /d	4	4,5	5	6	7	8	9	10	11
f _{hef} = 0,05 · (h _{ef} / d) ^{1,68}	0,51	0,63	0,75	1,01	1,31	1,64	2,00	2,39	2,81
h _{ef} /d	12	13	14	15	16	17	18	19	20
f _{hef} = 0,05 · (h _{ef} / d) ^{1,68}	3,25	3,72	4,21	4,73	5,27	5,84	6,42	7,04	7,67

Influence of edge distance ^{a)}

c/d	4	6	8	10	15	20	30	40
f _c = (d / c) ^{0,19}	0,77	0,71	0,67	0,65	0,60	0,57	0,52	0,50

a) The edge distance shall not be smaller than the minimum edge distance c_{min} .

Combined tension and shear loading

For combined tension and shear loading see section "Anchor Design".

Precalculated values – design resistance values

All data applies to:

- non-cracked concrete C 20/25 – $f_{ck,cube} = 25 \text{ N/mm}^2$
- temperature range I (see Service temperature range)
- minimum thickness of base material
- no effects of dense reinforcement

Recommended loads can be calculated by dividing the design resistance by an overall partial safety factor for action $\gamma = 1,4$. The partial safety factors for action depend on the type of loading and shall be taken from national regulations.

Design resistance: non- cracked concrete C 20/25 - minimum embedment depth

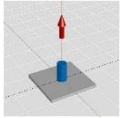
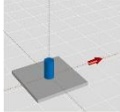
Anchor size		Ø8	Ø10	Ø12	Ø14	Ø16	Ø20	Ø25
Embedment depth $h_{ef} = h_{ef,min}$ [mm]		60	60	70	80	90	100	110
Base material thickness $h = h_{min}$ [mm]		100	100	102	116	130	150	174
	Tensile N_{Rd}: single anchor, no edge effects							
BSt 500 S [kN]		8,5	8,9	12,5	12,6	16,2	22,4	27,7
	Shear V_{Rd}: single anchor, no edge effects, without lever arm							
BSt 500 S [kN]		9,3	14,7	20,7	25,1	32,3	44,9	55,5

Design resistance: non- cracked concrete C 20/25 - minimum embedment depth

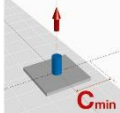
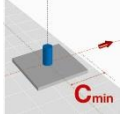
Anchor size		Ø8	Ø10	Ø12	Ø14	Ø16	Ø20	Ø25
Embedment depth $h_{ef} = h_{ef,min}$ [mm]		60	60	70	80	90	100	110
Base material thickness $h = h_{min}$ [mm]		100	100	102	116	130	150	174
Edge distance $c = c_{min}$ [mm]		40	50	60	80	100	120	135
	Tensile N_{Rd}: single anchor, min. edge distance ($c = c_{min}$)							
BSt 500 S [kN]		5,3	6,0	8,5	9,4	13,0	17,4	21,5
	Shear V_{Rd}: single anchor, min. edge distance ($c = c_{min}$), without lever arm							
BSt 500 S [kN]		3,5	4,9	6,6	10,0	13,2	17,4	21,8

**Design resistance: non- cracked concrete C 20/25 - minimum embedment depth
(load values are valid for single anchor)**

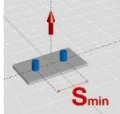
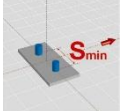
Anchor size		Ø8	Ø10	Ø12	Ø14	Ø16	Ø20	Ø25
Embedment depth $h_{ef} = h_{ef,min}$ [mm]		60	60	70	80	90	100	110
Base material thickness $h = h_{min}$ [mm]		100	100	100	116	138	156	170
Spacing $s = s_{min}$ [mm]		40	50	60	80	100	120	135
	Tensile N_{Rd}: double anchor, no edge effects, min. spacing ($s = s_{min}$)							
BSt 500 S [kN]		5,9	6,2	8,5	8,7	11,1	15,2	19,3
	Shear V_{Rd}: double anchor, no edge effects, min. spacing ($s = s_{min}$), without lever arm							
BSt 500 S [kN]		9,3	11,4	16,0	16,2	20,9	29,9	40,4

Design resistance: non- cracked concrete C 20/25 - typical embedment depth

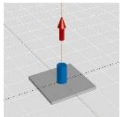
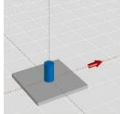
Anchor size		Ø8	Ø10	Ø12	Ø14	Ø16	Ø20	Ø25
Embedment depth $h_{ef} = h_{ef,typ}$ [mm]		80	90	110	125	145	170	210
Base material thickness $h = h_{min}$ [mm]		110	120	142	161	185	220	274
	Tensile N_{Rd}: single anchor, no edge effects							
BSt 500 S [kN]		11,4	13,4	19,6	19,6	26,0	38,1	58,9
	Shear V_{Rd}: single anchor, no edge effects, without lever arm							
BSt 500 S [kN]		9,3	14,7	20,7	28,0	36,7	57,3	90,0

Design resistance: non- cracked concrete C 20/25 - typical embedment depth

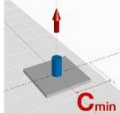
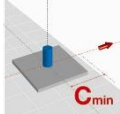
Anchor size		Ø8	Ø10	Ø12	Ø14	Ø16	Ø20	Ø25
Embedment depth $h_{ef} = h_{ef,typ}$ [mm]		80	90	110	125	145	170	210
Base material thickness $h = h_{min}$ [mm]		110	120	142	161	185	220	274
Edge distance $c = c_{min}$ [mm]		40	50	60	80	100	120	135
	Tensile N_{Rd}: single anchor, min. edge distance ($c = c_{min}$)							
BSt 500 S [kN]		7,0	8,3	12,1	13,4	18,8	26,9	37,0
	Shear V_{Rd}: single anchor, min. edge distance ($c = c_{min}$), without lever arm							
BSt 500 S [kN]		3,7	5,3	7,3	11,2	15,8	21,5	27,5

Design resistance: non- cracked concrete C 20/25 - typical embedment depth (load values are valid for single anchor)

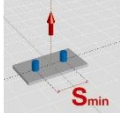
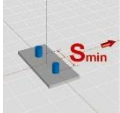
Anchor size		Ø8	Ø10	Ø12	Ø14	Ø16	Ø20	Ø25
Embedment depth $h_{ef} = h_{ef,typ}$ [mm]		80	90	110	125	145	170	210
Base material thickness $h = h_{min}$ [mm]		110	120	142	161	185	220	274
Spacing $s = s_{min}$ [mm]		40	50	60	80	100	120	135
	Tensile N_{Rd}: double anchor, no edge effects, min. spacing ($s = s_{min}$)							
BSt 500 S [kN]		8,0	9,3	13,4	13,7	18,0	25,8	40,2
	Shear V_{Rd}: double anchor, no edge effects, min. spacing ($s = s_{min}$), without lever arm							
BSt 500 S [kN]		9,3	14,7	20,7	23,3	30,8	45,6	72,9

Design resistance: non- cracked concrete C 20/25 - embedment depth = 12 d^{a)}

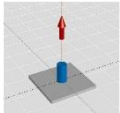
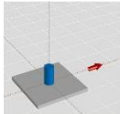
Anchor size		Ø8	Ø10	Ø12	Ø14	Ø16	Ø20	Ø25
Embedment depth $h_{ef} = 12 d^{a)}$ [mm]		96	120	144	168	192	240	300
Base material thickness $h = h_{min}$ [mm]		126	150	176	204	232	290	364
	Tensile N_{Rd}: single anchor, no edge effects							
BSt 500 S [kN]		13,7	17,8	25,6	26,4	34,5	53,9	84,1
	Shear V_{Rd}: single anchor, no edge effects, without lever arm							
BSt 500 S [kN]		9,3	14,7	20,7	28,0	36,7	57,3	90,0

Design resistance: non- cracked concrete C 20/25 - embedment depth = 12 d^{a)}

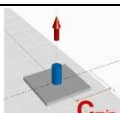
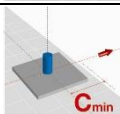

Anchor size		Ø8	Ø10	Ø12	Ø14	Ø16	Ø20	Ø25
Embedment depth $h_{ef} = 12 d^{a)}$ [mm]		96	120	144	168	192	240	300
Base material thickness $h = h_{min}$ [mm]		126	150	176	204	232	290	364
Edge distance $c = c_{min}$ [mm]		40	50	60	80	100	120	135
	Tensile N_{Rd}: single anchor, min. edge distance ($c = c_{min}$)							
BSt 500 S [kN]		8,4	11,0	15,8	18,1	24,9	37,9	55,9
	Shear V_{Rd}: single anchor, min. edge distance ($c = c_{min}$), without lever arm							
BSt 500 S [kN]		3,9	5,7	7,8	12,0	16,9	23,6	30,5

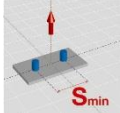
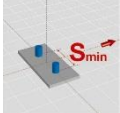
Design resistance: non- cracked concrete C 20/25 - embedment depth = 12 d^{a)}
(load values are valid for single anchor)

Anchor size		Ø8	Ø10	Ø12	Ø14	Ø16	Ø20	Ø25
Embedment depth $h_{ef} = 12 d^{a)}$ [mm]		96	120	144	168	192	240	300
Base material thickness $h = h_{min}$ [mm]		126	150	176	204	232	290	364
Spacing $s = s_{min}$ [mm]		40	50	60	80	100	120	135
	Tensile N_{Rd}: double anchor, no edge effects, min. spacing ($s = s_{min}$)							
BSt 500 S [kN]		9,7	12,5	17,9	18,7	24,2	37,3	59,2
	Shear V_{Rd}: double anchor, no edge effects, min. spacing ($s = s_{min}$), without lever arm							
BSt 500 S [kN]		9,3	14,7	20,7	28,0	36,7	57,3	90,0

a) d = element diameter

Hilti HIT-HY 100 mortar with HIT-V rod

Injection mortar system		Benefits
	Hilti HIT-HY 100 500 ml foil pack (also available as 330 ml foil pack)	<ul style="list-style-type: none"> - suitable for cracked and non-cracked concrete C20/25 to C50/60 - suitable for dry and water saturated concrete - small edge distance and anchor spacing possible - high corrosion resistant - in service temperature range up to 80°C short term/50°C long term - manual cleaning for drill hole sizes ≤ 18 mm and embedment depth $h_{ef} \leq 10d$ - embedment depth range M8: 60 to 160 mm M30: 120 to 600 mm
	Static mixer	
	HIT-V rods HIT-V-F HIT-V-R rods HIT-V-HCR rods	



Concrete



Tensile zone

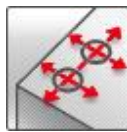

Small edge distance and spacing

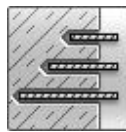

Variable embedment depth

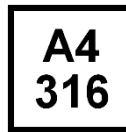

Corrosion resistance



High corrosion resistance



European Technical Approval



CE conformity

Approvals / certificates

Description	Authority / Laboratory	No. / date of issue
European Technical Approval ^{a)}	CSTB, Paris France	ETA-14/0009 / 2014-05-24

a) All data given in this section according ETA-14/0009 issue 2014-05-24.

Basic loading data (for a single anchor)

All data in this section applies to

For details see Simplified design method

- Correct setting (See setting instruction)
- No edge distance and spacing influence
- Steel failure
- Base material thickness, as specified in the table
- One typical embedment depth, as specified in the table
- One anchor material, as specified in the tables
- Concrete C 20/25, $f_{ck,cube} = 25$ N/mm²
- Temperature range I
(min. base material temperature -40°C, max. long term/short term base material temperature: +24°C/40°C)
- Installation temperature range -10°C to +40°C

Embedment depth ^{a)} and base material thickness for the basic loading data.
Mean ultimate resistance, characteristic resistance, design resistance, recommended loads.

Anchor size	M8	M10	M12	M16	M20	M24	M27	M30
Typical embedment depth h_{ef} [mm]	80	90	110	125	170	210	240	270
Base material thickness h [mm]	110	120	140	165	220	270	300	340

a) The allowed range of embedment depth is shown in the setting details. The corresponding load values can be calculated according to the simplified design method.

Mean ultimate resistance: concrete C 20/25 , anchor HIT-V 5.8

Anchor size	M8	M10	M12	M16	M20	M24	M27	M30
Non-cracked concrete								
Tensile $N_{R_{u,m}}$ HIT-V 5.8 [kN]	18,9	30,5	44,1	83,0	129,2	185,9	241,5	287,2
Shear $V_{R_{u,m}}$ HIT-V 5.8 [kN]	9,5	15,8	22,1	41,0	64,1	92,4	120,8	147,0
Cracked concrete								
Tensile $N_{R_{u,m}}$ HIT-V 5.8 [kN]	-	20,6	30,3	45,9	-	-	-	-
Shear $V_{R_{u,m}}$ HIT-V 5.8 [kN]	-	15,8	22,1	41,0	-	-	-	-

Characteristic resistance: concrete C 20/25 , anchor HIT-V 5.8

Anchor size	M8	M10	M12	M16	M20	M24	M27	M30
Non-cracked concrete								
Tensile N_{R_k} HIT-V 5.8 [kN]	18,0	29,0	42,0	70,6	111,9	153,7	187,8	216,3
Shear V_{R_k} HIT-V 5.8 [kN]	9,0	15,0	21,0	39,0	61,0	88,0	115,0	140,0
Cracked concrete								
Tensile $N_{R_{u,m}}$ HIT-V 5.8 [kN]	-	15,6	22,8	34,6	-	-	-	-
Shear $V_{R_{u,m}}$ HIT-V 5.8 [kN]	-	15,0	21,0	39,0	-	-	-	-

Design resistance: concrete C 20/25 , anchor HIT-V 5.8

Anchor size	M8	M10	M12	M16	M20	M24	M27	M30
Non-cracked concrete								
Tensile N_{R_d} HIT-V 5.8 [kN]	12,0	19,3	28,0	39,2	62,2	85,4	104,3	120,2
Shear V_{R_d} HIT-V 5.8 [kN]	7,2	12,0	16,8	31,2	48,8	70,4	92,0	112,0
Cracked concrete								
Tensile $N_{R_{u,m}}$ HIT-V 5.8 [kN]	-	8,6	12,7	19,2	-	-	-	-
Shear $V_{R_{u,m}}$ HIT-V 5.8 [kN]	-	12,0	16,8	31,2	-	-	-	-

Recommended loads ^{a)}: concrete C 20/25 , anchor HIT-V 5.8

Anchor size	M8	M10	M12	M16	M20	M24	M27	M30
Non-cracked concrete								
Tensile N_{rec} HIT-V 5.8 [kN]	8,6	13,8	20,0	28,0	44,4	61,0	74,5	85,8
Shear V_{rec} HIT-V 5.8 [kN]	5,1	8,6	12,0	22,3	34,9	50,3	65,7	80,0
Cracked concrete								
Tensile $N_{R_{u,m}}$ HIT-V 5.8 [kN]	-	6,2	9,1	13,7	-	-	-	-
Shear $V_{R_{u,m}}$ HIT-V 5.8 [kN]	-	8,6	12,0	22,3	-	-	-	-

a) With overall partial safety factor for action $\gamma = 1,4$. The partial safety factors for action depend on the type of loading and shall be taken from national regulations.

Service temperature range

Hilti HIT-HY 100 injection mortar may be applied in the temperature ranges given below. An elevated base material temperature may lead to a reduction of the design bond resistance.

Temperature range	Base material temperature	Maximum long term base material temperature	Maximum short term base material temperature
Temperature range I	-40 °C to +40 °C	+24 °C	+40 °C
Temperature range II	-40 °C to +80 °C	+50 °C	+80 °C

Max short term base material temperature

Short-term elevated base material temperatures are those that occur over brief intervals, e.g. as a result of diurnal cycling.

Max long term base material temperature

Long-term elevated base material temperatures are roughly constant over significant periods of time.

Materials

Mechanical properties of HIT-V

Anchor size			M8	M10	M12	M16	M20	M24	M27	M30
Nominal tensile strength f_{uk}	HIT-V 5.8	[N/mm ²]	500	500	500	500	500	500	500	500
	HIT-V 8.8	[N/mm ²]	800	800	800	800	800	800	800	800
	HIT-V-R	[N/mm ²]	700	700	700	700	700	700	500	500
	HIT-V-HCR	[N/mm ²]	800	800	800	800	800	700	700	700
Yield strength f_{yk}	HIT-V 5.8	[N/mm ²]	400	400	400	400	400	400	400	400
	HIT-V 8.8	[N/mm ²]	640	640	640	640	640	640	640	640
	HIT-V-R	[N/mm ²]	450	450	450	450	450	450	210	210
	HIT-V-HCR	[N/mm ²]	600	600	600	600	600	400	400	400
Stressed cross-section A_s	HIT-V	[mm ²]	36,6	58,0	84,3	157	245	353	459	561
Moment of resistance W	HIT-V	[mm ³]	31,2	62,3	109	277	541	935	1387	1874

Material quality

Part	Material
Threaded rod HIT-V(-F), 5.8: M8 – M24	Strength class 5.8, A ₅ > 8% ductile steel galvanized ≥ 5 μm, (F) hot dipped galvanized ≥ 45 μm,
Threaded rod HIT-V(-F), 8.8: M27 – M30	Strength class 8.8, A ₅ > 8% ductile steel galvanized ≥ 5 μm, (F) hot dipped galvanized ≥ 45 μm,
Threaded rod HIT-V-R	Stainless steel grade A4, A ₅ > 8% ductile strength class 70 for ≤ M24 and class 50 for M27 to M30, 1.4401; 1.4404; 1.4578; 1.4571; 1.4439; 1.4362
Threaded rod HIT-V-HCR	High corrosion resistant steel, 1.4529; 1.4565 strength ≤ M20: R _m = 800 N/mm ² , R _{p0.2} = 640 N/mm ² , A ₅ > 8% ductile M24 to M30: R _m = 700 N/mm ² , R _{p0.2} = 400 N/mm ² , A ₅ > 8% ductile
Washer ISO 7089	Steel galvanized, hot dipped galvanized,
	Stainless steel, 1.4401; 1.4404; 1.4578; 1.4571; 1.4439; 1.4362
	High corrosion resistant steel, 1.4529; 1.4565
Nut EN ISO 4032	Strength class 8, steel galvanized ≥ 5 μm, hot dipped galvanized ≥ 45 μm
	Strength class 70, stainless steel grade A4, 1.4401; 1.4404; 1.4578; 1.4571; 1.4439; 1.4362
	Strength class 70, high corrosion resistant steel, 1.4529; 1.4565

Setting

installation equipment

Anchor size	M8	M10	M12	M16	M20	M24	M27	M30
Rotary hammer	TE 2 – TE 30				TE 40 – TE 70			
Other tools	compressed air gun or blow out pump, set of cleaning brushes, dispenser							

Setting instruction

Dry and water-saturated concrete, hammer drilling

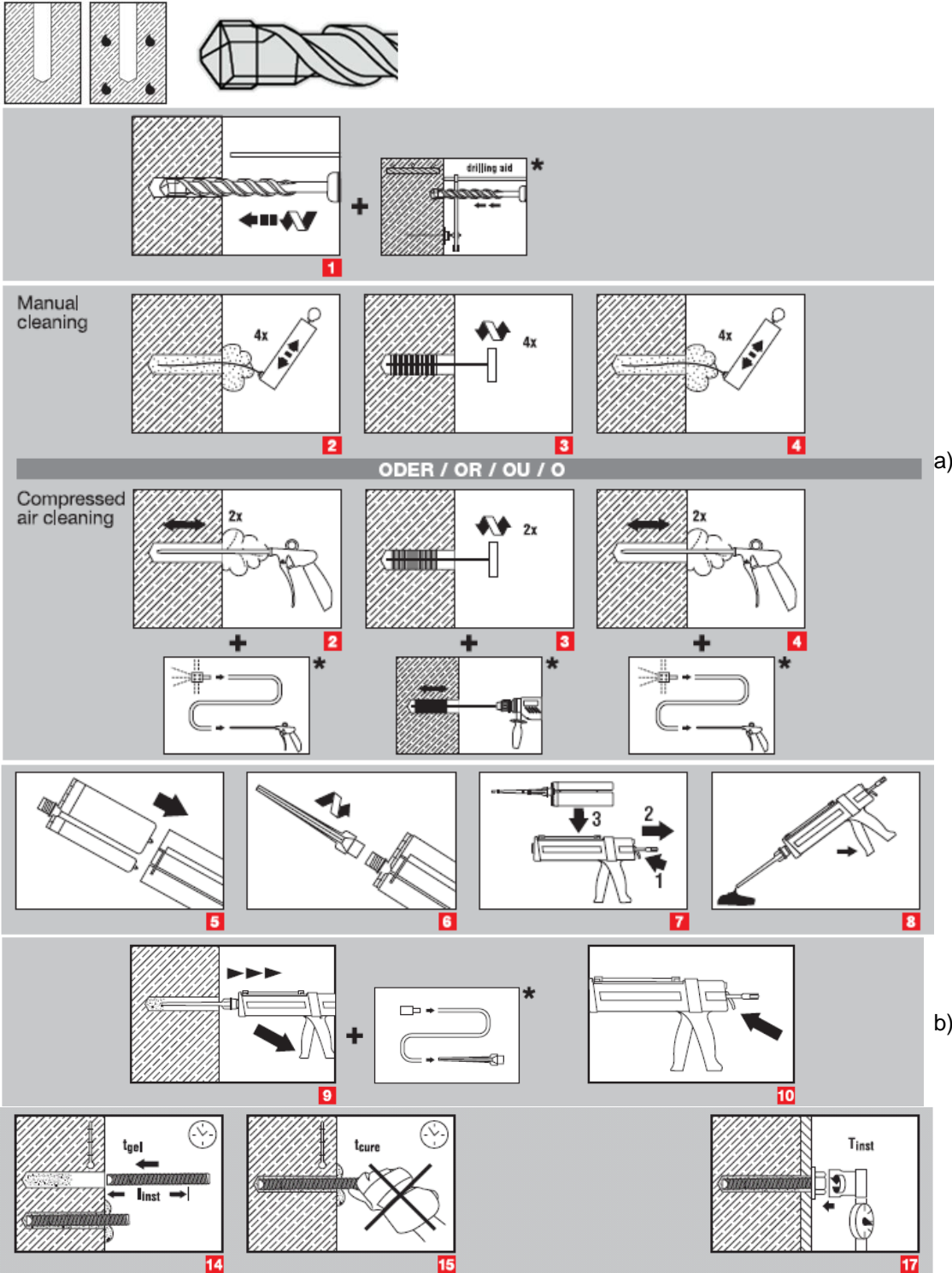

a) Note: Manual cleaning for drill hole sizes $d_0 \leq 18\text{mm}$ and embedment depth $h_{ef} \leq 10 d$ only!

Compressed air cleaning for all bore hole diameters and all bore hole depth

b) Note: Extension and piston plug needed for overhead installation and/or embedment depth $> 250\text{mm}$!

For detailed information on installation see instruction for use given with the package of the product.

Working time, Curing time

Temperature of the base material T_{BM}	Working time t_{gel}	Curing time $t_{cure}^{a)}$
$-10\text{ °C} < T_{BM} < -6\text{ °C}$	180 min	12 h
$-5\text{ °C} < T_{BM} < -1\text{ °C}$	40 min	4 h
$0\text{ °C} < T_{BM} < +4\text{ °C}$	20 min	2 h
$+5\text{ °C} < T_{BM} < +9\text{ °C}$	8 min	1 h
$+10\text{ °C} < T_{BM} < +14\text{ °C}$	7 min	50 min
$+15\text{ °C} < T_{BM} < +19\text{ °C}$	6 min	40 min
$+20\text{ °C} < T_{BM} < +24\text{ °C}$	5 min	30 min
$+25\text{ °C} < T_{BM} < +29\text{ °C}$	3 min	30 min
$+30\text{ °C} < T_{BM} \leq +40\text{ °C}$	2 min	30 min

Setting details

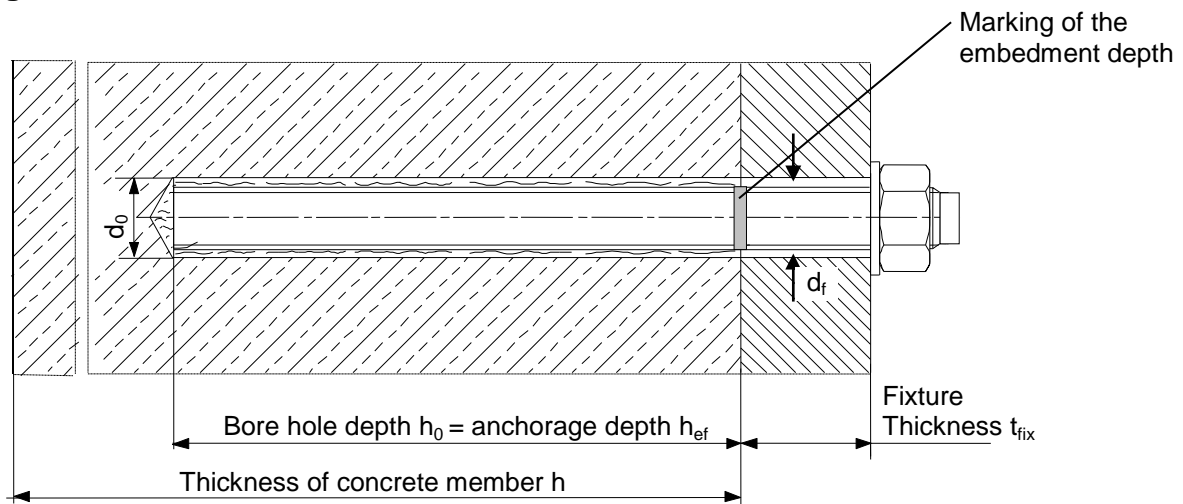

Setting details

Anchor size		M8	M10	M12	M16	M20	M24	M27	M30
Nominal diameter of drill bit	d_0 [mm]	10	12	14	18	22	28	30	35
Effective embedment and drill hole depth range ^{a)} for HIT-V	$h_{ef,min}$ [mm]	60	60	70	80	90	100	110	120
	$h_{ef,max}$ [mm]	160	200	240	320	400	480	540	600
Minimum base material thickness	h_{min} [mm]	$h_{ef} + 30 \text{ mm}$ $\geq 100 \text{ mm}$			$h_{ef} + 2 d_0$				
Diameter of clearance hole in the fixture	d_f [mm]	9	12	14	18	22	26	30	33
Torque moment	T_{max} ^{b)} [Nm]	10	20	40	80	150	200	270	300
Minimum spacing	s_{min} [mm]	40	50	60	80	100	120	135	150
Minimum edge distance	c_{min} [mm]	40	50	60	80	100	120	135	150
Critical spacing for splitting failure	$s_{cr,sp}$ [mm]	$2 c_{cr,sp}$							
Critical edge distance for splitting failure ^{c)}	$c_{cr,sp}$ [mm]	$1,0 \cdot h_{ef}$ for $h / h_{ef} \geq 2,0$							
		$4,6 h_{ef} - 1,8 h$ for $2,0 > h / h_{ef} > 1,3$							
		$2,26 h_{ef}$ for $h / h_{ef} \leq 1,3$							
Critical spacing for concrete cone failure	$s_{cr,N}$ [mm]	$2 c_{cr,N}$							
Critical edge distance for concrete cone failure ^{d)}	$c_{cr,N}$ [mm]	$1,5 h_{ef}$							

For spacing (or edge distance) smaller than critical spacing (or critical edge distance) the design loads have to be reduced.

- a) Embedment depth range: $h_{ef,min} \leq h_{ef} \leq h_{ef,max}$
- b) Maximum recommended torque moment to avoid splitting failure during installation with minimum spacing and/or edge distance.
- c) h : base material thickness ($h \geq h_{min}$), h_{ef} : embedment depth
- d) The critical edge distance for concrete cone failure depends on the embedment depth h_{ef} and the design bond resistance. The simplified formula given in this table is on the save side.

Simplified design method

Simplified version of the design method according ETAG 001, TR 029.

- Influence of concrete strength
- Influence of edge distance
- Influence of spacing
- Valid for a group of two anchors. (The method may also be applied for anchor groups with more than two anchors or more than one edge distance. The influencing factors must then be considered for each edge distance and spacing. The calculated design loads are then on the safe side: They will be lower than the exact values according ETAG 001, TR 029. To avoid this, it is recommended to use the anchor design software PROFIS anchor)

The design method is based on the following simplification:

- No different loads are acting on individual anchors (no eccentricity)

The values are valid for one anchor.

For more complex fastening applications please use the anchor design software PROFIS Anchor.

Tension loading

The design tensile resistance is the lower value of

- Steel resistance: $N_{Rd,s}$
- Combined pull-out and concrete cone resistance: $N_{Rd,p} = N_{Rd,p}^0 \cdot f_{B,p} \cdot f_{1,N} \cdot f_{2,N} \cdot f_{3,N} \cdot f_{h,p} \cdot f_{re,N}$
- Concrete cone resistance: $N_{Rd,c} = N_{Rd,c}^0 \cdot f_B \cdot f_{1,N} \cdot f_{2,N} \cdot f_{3,N} \cdot f_{h,N} \cdot f_{re,N}$
- Concrete splitting resistance (only non-cracked concrete): $N_{Rd,sp} = N_{Rd,c}^0 \cdot f_B \cdot f_{1,sp} \cdot f_{2,sp} \cdot f_{3,sp} \cdot f_{h,N} \cdot f_{re,N}$

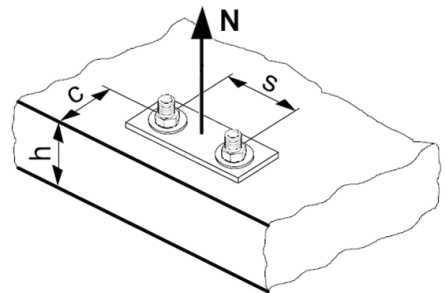

Basic design tensile resistance

Design steel resistance $N_{Rd,s}$

Anchor size		M8	M10	M12	M16	M20	M24	M27	M30
$N_{Rd,s}$	HIT-V 5.8 [kN]	12,0	19,3	28,0	52,7	82,0	118,0	153,3	187,3
	HIT-V 8.8 [kN]	19,3	30,7	44,7	84,0	130,7	188,0	244,7	299,3
	HIT-V-R [kN]	13,9	21,9	31,6	58,8	92,0	132,1	80,4	98,3
	HIT-V-HCR [kN]	19,3	30,7	44,7	84,0	130,7	117,6	152,9	187,1

Design combined pull-out and concrete cone resistance

$$N_{Rd,p} = N_{Rd,p}^0 \cdot f_{B,p} \cdot f_{1,N} \cdot f_{2,N} \cdot f_{3,N} \cdot f_{h,p} \cdot f_{re,N}$$

Anchor size	M8	M10	M12	M16	M20	M24	M27	M30
Typical embedment depth $h_{ef} = h_{ef,typ}$ [mm]	80	90	110	125	170	210	240	270
Non-cracked concrete								
$N_{Rd,p}^0$ Temperature range I [kN]	15,6	22,0	32,3	45,4	71,2	96,8	113,1	120,2
$N_{Rd,p}^0$ Temperature range II [kN]	13,4	18,8	27,6	41,9	65,3	88,0	101,8	99,0
Cracked concrete								
$N_{Rd,p}^0$ Temperature range I [kN]	-	8,6	12,7	19,2	-	-	-	-
$N_{Rd,p}^0$ Temperature range II [kN]	-	-	-	-	-	-	-	-

Design concrete cone resistance $N_{Rd,c} = N_{Rd,c}^0 \cdot f_B \cdot f_{1,N} \cdot f_{2,N} \cdot f_{3,N} \cdot f_{h,N} \cdot f_{re,N}$

Design splitting resistance $N_{Rd,sp} = N_{Rd,c}^0 \cdot f_B \cdot f_{1,sp} \cdot f_{2,sp} \cdot f_{3,sp} \cdot f_{h,N} \cdot f_{re,N}$

Anchor size			M8	M10	M12	M16	M20	M24	M27	M30
$N_{Rd,c}^0$ Non-cracked concrete	[kN]		20,1	24,0	32,4	39,2	62,2	85,4	104,3	124,5
$N_{Rd,c}^0$ Cracked concrete	[kN]		-	17,1	23,1	27,9	-	-	-	-

Influencing factors

Influence of concrete strength on combined pull-out and concrete cone resistance

Concrete strength designation (ENV 206)	C 20/25	C 25/30	C 30/37	C 35/45	C 40/50	C 45/55	C 50/60
$f_{B,p} = (f_{ck,cube}/25N/mm^2)^{0,15}$ a)	1,00	1,02	1,04	1,06	1,07	1,08	1,09

a) $f_{ck,cube}$ = concrete compressive strength, measured on cubes with 150 mm side length

Influence of embedment depth on combined pull-out and concrete cone resistance

$f_{h,p} = h_{ef}/h_{ef,typ}$

Influence of concrete strength on concrete cone resistance

Concrete strength designation (ENV 206)	C 20/25	C 25/30	C 30/37	C 35/45	C 40/50	C 45/55	C 50/60
$f_B = (f_{ck,cube}/25N/mm^2)^{0,5}$ a)	1	1,1	1,22	1,34	1,41	1,48	1,55

a) $f_{ck,cube}$ = concrete compressive strength, measured on cubes with 150 mm side length

Influence of edge distance a)

$c/c_{cr,N}$	0,1	0,2	0,3	0,4	0,5	0,6	0,7	0,8	0,9	1
$c/c_{cr,sp}$										
$f_{1,N} = 0,7 + 0,3 \cdot c/c_{cr,N} \leq 1$	0,73	0,76	0,79	0,82	0,85	0,88	0,91	0,94	0,97	1
$f_{1,sp} = 0,7 + 0,3 \cdot c/c_{cr,sp} \leq 1$										
$f_{2,N} = 0,5 \cdot (1 + c/c_{cr,N}) \leq 1$	0,55	0,60	0,65	0,70	0,75	0,80	0,85	0,90	0,95	1
$f_{2,sp} = 0,5 \cdot (1 + c/c_{cr,sp}) \leq 1$										

a) The edge distance shall not be smaller than the minimum edge distance c_{min} . These influencing factors must be considered for every edge distance smaller than the critical edge distance.

Influence of anchor spacing a)

$s/s_{cr,N}$	0,1	0,2	0,3	0,4	0,5	0,6	0,7	0,8	0,9	1
$s/s_{cr,sp}$										
$f_{3,N} = 0,5 \cdot (1 + s/s_{cr,N}) \leq 1$	0,55	0,60	0,65	0,70	0,75	0,80	0,85	0,90	0,95	1
$f_{3,sp} = 0,5 \cdot (1 + s/s_{cr,sp}) \leq 1$										

a) The anchor spacing shall not be smaller than the minimum anchor spacing s_{min} . This influencing factor must be considered for every anchor spacing.

Influence of embedment depth on concrete cone resistance

$f_{h,N} = (h_{ef}/h_{ef,typ})^{1,5}$

Influence of reinforcement

h_{ef} [mm]	40	50	60	70	80	90	≥ 100
$f_{re,N} = 0,5 + h_{ef}/200\text{mm} \leq 1$	0,7 ^{a)}	0,75 ^{a)}	0,8 ^{a)}	0,85 ^{a)}	0,9 ^{a)}	0,95 ^{a)}	1

a) This factor applies only for dense reinforcement. If in the area of anchorage there is reinforcement with a spacing ≥ 150 mm (any diameter) or with a diameter ≤ 10 mm and a spacing ≥ 100 mm, then a factor $f_{re,N} = 1$ may be applied.

Shear loading

The design shear resistance is the lower value of

- Steel resistance: $V_{Rd,s}$
- Concrete pryout resistance: $V_{Rd,cp} = k \cdot \text{lower value of } N_{Rd,p} \text{ and } N_{Rd,c}$
- Concrete edge resistance: $V_{Rd,c} = V_{Rd,c}^0 \cdot f_B \cdot f_{\beta} \cdot f_h \cdot f_4 \cdot f_{hef} \cdot f_c$

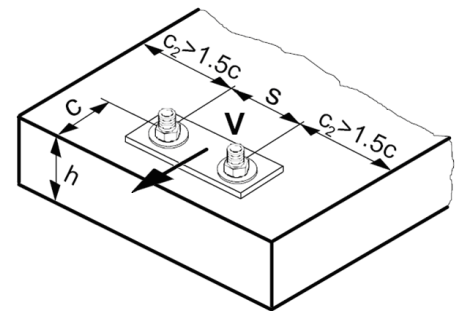

Basic design shear resistance

Design steel resistance $V_{Rd,s}$

Anchor size		M8	M10	M12	M16	M20	M24	M27	M30
$V_{Rd,s}$	HIT-V 5.8 [kN]	7,2	12,0	16,8	31,2	48,8	70,4	92,0	112,0
	HIT-V 8.8 [kN]	12,0	18,4	27,2	50,4	78,4	112,8	147,2	179,2
	HIT-V-R [kN]	8,3	12,8	19,2	35,3	55,1	79,5	48,3	58,8
	HIT-V-HCR [kN]	12,0	18,4	27,2	50,4	78,4	70,9	92,0	112,0

Design concrete pryout resistance $V_{Rd,cp} = \text{lower value}^a)$ of $k \cdot N_{Rd,p}$ and $k \cdot N_{Rd,c}$

$$k = 2 \text{ for } h_{ef} \geq 60 \text{ mm}$$

- a) $N_{Rd,p}$: Design combined pull-out and concrete cone resistance
 $N_{Rd,c}$: Design concrete cone resistance

Design concrete edge resistance $V_{Rd,c} = V_{Rd,c}^0 \cdot f_B \cdot f_{\beta} \cdot f_h \cdot f_4 \cdot f_{hef} \cdot f_c$

Anchor size		M8	M10	M12	M16	M20	M24	M27	M30
Non-cracked concrete									
$V_{Rd,c}^0$ [kN]		5,9	8,6	11,6	18,7	27,0	36,6	44,5	53,0
Cracked concrete									
$V_{Rd,c}^0$ [kN]		-	6,1	8,2	13,2	-	-	-	-

Influencing factors

Influence of concrete strength

Concrete strength designation (ENV 206)	C 20/25	C 25/30	C 30/37	C 35/45	C 40/50	C 45/55	C 50/60
$f_B = (f_{ck,cube}/25\text{N/mm}^2)^{1/2 \text{ a)}$	1	1,1	1,22	1,34	1,41	1,48	1,55

- a) $f_{ck,cube}$ = concrete compressive strength, measured on cubes with 150 mm side length

Influence of angle between load applied and the direction perpendicular to the free edge

Angle β	0°	10°	20°	30°	40°	50°	60°	70°	80°	≥ 90°
$f_{\beta} = \sqrt{\frac{1}{(\cos \alpha_v)^2 + \left(\frac{\sin \alpha_v}{2,5}\right)^2}}$	1	1,01	1,05	1,13	1,24	1,40	1,64	1,97	2,32	2,50

Influence of base material thickness

h/c	0,15	0,3	0,45	0,6	0,75	0,9	1,05	1,2	1,35	≥ 1,5
$f_h = \{h/(1,5 \cdot c)\}^{1/2} \leq 1$	0,32	0,45	0,55	0,63	0,71	0,77	0,84	0,89	0,95	1,00

Influence of anchor spacing and edge distance ^{a)} for concrete edge resistance: f_4

$$f_4 = (c/h_{ef})^{1,5} \cdot (1 + s / [3 \cdot c]) \cdot 0,5$$

c/h _{ef}	Single anchor	Group of two anchors s/h _{ef}														
		0,75	1,50	2,25	3,00	3,75	4,50	5,25	6,00	6,75	7,50	8,25	9,00	9,75	10,50	11,25
0,50	0,35	0,27	0,35	0,35	0,35	0,35	0,35	0,35	0,35	0,35	0,35	0,35	0,35	0,35	0,35	0,35
0,75	0,65	0,43	0,54	0,65	0,65	0,65	0,65	0,65	0,65	0,65	0,65	0,65	0,65	0,65	0,65	0,65
1,00	1,00	0,63	0,75	0,88	1,00	1,00	1,00	1,00	1,00	1,00	1,00	1,00	1,00	1,00	1,00	1,00
1,25	1,40	0,84	0,98	1,12	1,26	1,40	1,40	1,40	1,40	1,40	1,40	1,40	1,40	1,40	1,40	1,40
1,50	1,84	1,07	1,22	1,38	1,53	1,68	1,84	1,84	1,84	1,84	1,84	1,84	1,84	1,84	1,84	1,84
1,75	2,32	1,32	1,49	1,65	1,82	1,98	2,15	2,32	2,32	2,32	2,32	2,32	2,32	2,32	2,32	2,32
2,00	2,83	1,59	1,77	1,94	2,12	2,30	2,47	2,65	2,83	2,83	2,83	2,83	2,83	2,83	2,83	2,83
2,25	3,38	1,88	2,06	2,25	2,44	2,63	2,81	3,00	3,19	3,38	3,38	3,38	3,38	3,38	3,38	3,38
2,50	3,95	2,17	2,37	2,57	2,77	2,96	3,16	3,36	3,56	3,76	3,95	3,95	3,95	3,95	3,95	3,95
2,75	4,56	2,49	2,69	2,90	3,11	3,32	3,52	3,73	3,94	4,15	4,35	4,56	4,56	4,56	4,56	4,56
3,00	5,20	2,81	3,03	3,25	3,46	3,68	3,90	4,11	4,33	4,55	4,76	4,98	5,20	5,20	5,20	5,20
3,25	5,86	3,15	3,38	3,61	3,83	4,06	4,28	4,51	4,73	4,96	5,18	5,41	5,63	5,86	5,86	5,86
3,50	6,55	3,51	3,74	3,98	4,21	4,44	4,68	4,91	5,14	5,38	5,61	5,85	6,08	6,31	6,55	6,55
3,75	7,26	3,87	4,12	4,36	4,60	4,84	5,08	5,33	5,57	5,81	6,05	6,29	6,54	6,78	7,02	7,26
4,00	8,00	4,25	4,50	4,75	5,00	5,25	5,50	5,75	6,00	6,25	6,50	6,75	7,00	7,25	7,50	7,75
4,25	8,76	4,64	4,90	5,15	5,41	5,67	5,93	6,18	6,44	6,70	6,96	7,22	7,47	7,73	7,99	8,25
4,50	9,55	5,04	5,30	5,57	5,83	6,10	6,36	6,63	6,89	7,16	7,42	7,69	7,95	8,22	8,49	8,75
4,75	10,35	5,45	5,72	5,99	6,27	6,54	6,81	7,08	7,36	7,63	7,90	8,17	8,45	8,72	8,99	9,26
5,00	11,18	5,87	6,15	6,43	6,71	6,99	7,27	7,55	7,83	8,11	8,39	8,66	8,94	9,22	9,50	9,78
5,25	12,03	6,30	6,59	6,87	7,16	7,45	7,73	8,02	8,31	8,59	8,88	9,17	9,45	9,74	10,02	10,31
5,50	12,90	6,74	7,04	7,33	7,62	7,92	8,21	8,50	8,79	9,09	9,38	9,67	9,97	10,26	10,55	10,85

a) The anchor spacing and the edge distance shall not be smaller than the minimum anchor spacing s_{min} and the minimum edge distance c_{min} .

Influence of embedment depth

h _{ef} /d	4	4,5	5	6	7	8	9	10	11
$f_{hef} = 0,05 \cdot (h_{ef} / d)^{1,68}$	0,51	0,63	0,75	1,01	1,31	1,64	2,00	2,39	2,81
h _{ef} /d	12	13	14	15	16	17	18	19	20
$f_{hef} = 0,05 \cdot (h_{ef} / d)^{1,68}$	3,25	3,72	4,21	4,73	5,27	5,84	6,42	7,04	7,67

Influence of edge distance ^{a)}

c/d	4	6	8	10	15	20	30	40
$f_c = (d / c)^{0,19}$	0,77	0,71	0,67	0,65	0,60	0,57	0,52	0,50

a) The edge distance shall not be smaller than the minimum edge distance c_{min} .

Combined tension and shear loading

For combined tension and shear loading see section "Anchor Design".

Precalculated values – design resistance values

All data applies to:

- non-cracked concrete C 20/25 – $f_{ck,cube} = 25 \text{ N/mm}^2$
- temperature range I (see Service temperature range)
- minimum thickness of base material
- no effects of dense reinforcement

Recommended loads can be calculated by dividing the design resistance by an overall partial safety factor for action $\gamma = 1,4$. The partial safety factors for action depend on the type of loading and shall be taken from national regulations.

Design resistance: concrete C 20/25 – $f_{ck,cube} = 25 \text{ N/mm}^2$ - minimum embedment depth

Anchor size	M8	M10	M12	M16	M20	M24	M27	M30
Embedment depth $h_{ef} = h_{ef,min}$ [mm]	60	60	70	80	90	100	110	120
Base material thickness $h = h_{min}$ [mm]	100	100	100	116	138	156	170	190
Tensile N_{Rd}: single anchor, no edge effects								
Non-cracked concrete								
HIT-V 5.8								
HIT-V 8.8								
HIT-V-R								
HIT-V-HCR								
[kN]	11,7	13,0	16,4	20,1	24,0	28,1	32,4	36,9
Cracked concrete								
HIT-V 5.8								
HIT-V 8.8								
HIT-V-R								
HIT-V-HCR								
[kN]	-	5,8	8,1	12,3	-	-	-	-
Shear V_{Rd}: single anchor, no edge effects, without lever arm								
Non-cracked concrete								
HIT-V 5.8								
HIT-V 8.8								
HIT-V-R								
HIT-V-HCR								
[kN]	7,2	12,0	16,8	31,2	48,8	67,3	77,7	88,5
[kN]	12,0	18,4	27,2	48,2	57,5	67,3	77,7	88,5
[kN]	8,3	12,8	19,2	35,3	55,1	67,3	48,3	58,8
[kN]	12,0	18,4	27,2	48,2	57,5	67,3	77,7	88,5
Cracked concrete								
HIT-V 5.8								
HIT-V 8.8								
HIT-V-R								
HIT-V-HCR								
[kN]	-	12,0	16,8	29,5	-	-	-	-
[kN]	-	13,8	19,4	29,5	-	-	-	-
[kN]	-	12,8	19,2	29,5	-	-	-	-
[kN]	-	13,8	19,4	29,5	-	-	-	-

Design resistance: concrete C 20/25 – $f_{ck,cube} = 25 \text{ N/mm}^2$ - minimum embedment depth

Anchor size	M8	M10	M12	M16	M20	M24	M27	M30
Embedment depth $h_{ef} = h_{ef,min}$ [mm]	60	60	70	80	90	100	110	120
Base material thickness $h = h_{min}$ [mm]	100	100	100	116	138	156	170	190
Edge distance $c = c_{min}$ [mm]	40	50	60	80	100	120	135	150
Tensile N_{Rd}: single anchor, min. edge distance ($c = c_{min}$)								
Non-cracked concrete								
HIT-V 5.8 HIT-V 8.8 HIT-V-R HIT-V-HCR [kN]	7,1	7,8	9,7	12,8	16,5	21,1	24,5	28,9
Cracked concrete								
HIT-V 5.8 HIT-V 8.8 HIT-V-R HIT-V-HCR [kN]	-	3,9	5,5	9,1	-	-	-	-
Shear V_{Rd}: single anchor, min. edge distance ($c = c_{min}$), without lever arm								
Non-cracked concrete								
HIT-V 5.8 HIT-V 8.8 HIT-V-R HIT-V-HCR [kN]	3,5	4,9	6,6	10,2	14,1	18,3	21,8	25,9
Cracked concrete								
HIT-V 5.8 HIT-V 8.8 HIT-V-R HIT-V-HCR [kN]	-	3,5	4,7	7,2	-	-	-	-

**Design resistance: concrete C 20/25 – $f_{ck,cube} = 25 \text{ N/mm}^2$ - minimum embedment depth
(load values are valid for single anchor)**

Anchor size	M8	M10	M12	M16	M20	M24	M27	M30
Embedment depth $h_{ef} = h_{ef,min}$ [mm]	60	60	70	80	90	100	110	120
Base material thickness $h = h_{min}$ [mm]	100	100	100	116	138	156	170	190
Spacing $s = s_{min}$ [mm]	40	50	60	80	100	120	135	150
Tensile N_{Rd}: double anchor, no edge effects, min. spacing ($s = s_{min}$)								
Non-cracked concrete								
HIT-V 5.8 HIT-V 8.8 HIT-V-R HIT-V-HCR [kN]	7,4	7,9	10,0	12,6	15,4	18,7	21,6	25,0
Cracked concrete								
HIT-V 5.8 HIT-V 8.8 HIT-V-R HIT-V-HCR [kN]	-	4,1	5,6	8,5	-	-	-	-
Shear V_{Rd}: double anchor, no edge effects, min. spacing ($s = s_{min}$), without lever arm								
Non-cracked concrete								
HIT-V 5.8 [kN]	7,2	12,0	16,8	31,2	39,4	47,1	54,7	62,7
HIT-V 8.8 [kN]	12,0	17,7	24,9	32,1	39,4	47,1	54,7	62,7
HIT-V-R [kN]	8,3	12,8	19,2	32,1	39,4	47,1	48,3	58,8
HIT-V-HCR [kN]	12,0	17,7	24,9	32,1	39,4	47,1	54,7	62,7
Cracked concrete								
HIT-V 5.8 [kN]	-	8,8	12,4	19,7	-	-	-	-
HIT-V 8.8 [kN]	-	8,8	12,4	19,7	-	-	-	-
HIT-V-R [kN]	-	8,8	12,4	19,7	-	-	-	-
HIT-V-HCR [kN]	-	8,8	12,4	19,7	-	-	-	-

Design resistance: concrete C 20/25 – $f_{ck,cube} = 25 \text{ N/mm}^2$ - typical embedment depth

Anchor size		M8	M10	M12	M16	M20	M24	M27	M30
Embedment depth $h_{ef} = h_{ef,typ}$ [mm]		80	90	110	125	170	210	240	270
Base material thickness $h = h_{min}$ [mm]		110	120	140	161	218	266	300	340
Tensile N_{Rd}: single anchor, no edge effects									
Non-cracked concrete									
HIT-V 5.8 [kN]		12,0	19,3	28,0	39,2	62,2	85,4	104,3	120,2
HIT-V 8.8 [kN]		15,6	22,0	32,3	39,2	62,2	85,4	104,3	120,2
HIT-V-R [kN]		13,9	21,9	31,6	39,2	62,2	85,4	80,4	98,3
HIT-V-HCR [kN]		15,6	22,0	32,3	39,2	62,2	85,4	104,3	120,2
Cracked concrete									
HIT-V 5.8 [kN]		-	8,6	12,7	19,2	-	-	-	-
HIT-V 8.8 [kN]		-	8,6	12,7	19,2	-	-	-	-
HIT-V-R [kN]		-	8,6	12,7	19,2	-	-	-	-
HIT-V-HCR [kN]		-	8,6	12,7	19,2	-	-	-	-
Shear V_{Rd}: single anchor, no edge effects, without lever arm									
Non-cracked concrete									
HIT-V 5.8 [kN]		7,2	12,0	16,8	31,2	48,8	70,4	92,0	112,0
HIT-V 8.8 [kN]		12,0	18,4	27,2	50,4	78,4	112,8	147,2	179,2
HIT-V-R [kN]		8,3	12,8	19,2	35,3	55,1	79,5	48,3	58,8
HIT-V-HCR [kN]		12,0	18,4	27,2	50,4	78,4	70,9	92,0	112,0
Cracked concrete									
HIT-V 5.8 [kN]		-	12,0	16,8	31,2	-	-	-	-
HIT-V 8.8 [kN]		-	18,4	27,2	46,1	-	-	-	-
HIT-V-R [kN]		-	12,8	19,2	35,3	-	-	-	-
HIT-V-HCR [kN]		-	18,4	27,2	46,1	-	-	-	-

Design resistance: concrete C 20/25 – $f_{ck,cube} = 25 \text{ N/mm}^2$ - typical embedment depth

Anchor size		M8	M10	M12	M16	M20	M24	M27	M30
Embedment depth $h_{ef} = h_{ef,typ}$ [mm]		80	90	110	125	170	210	240	270
Base material thickness $h = h_{min}$ [mm]		110	120	140	161	218	266	300	340
Edge distance $c = c_{min}$ [mm]		40	50	60	80	100	120	135	150
Tensile N_{Rd}: single anchor, min. edge distance ($c = c_{min}$)									
Non-cracked concrete									
HIT-V 5.8 [kN]		8,6	11,6	15,5	19,7	30,5	41,5	50,5	60,0
HIT-V 8.8 [kN]		8,6	11,6	15,5	19,7	30,5	41,5	50,5	60,0
HIT-V-R [kN]		8,6	11,6	15,5	19,7	30,5	41,5	50,5	60,0
HIT-V-HCR [kN]		8,6	11,6	15,5	19,7	30,5	41,5	50,5	60,0
Cracked concrete									
HIT-V 5.8 [kN]		-	4,8	7,0	11,3	-	-	-	-
HIT-V 8.8 [kN]		-	4,8	7,0	11,3	-	-	-	-
HIT-V-R [kN]		-	4,8	7,0	11,3	-	-	-	-
HIT-V-HCR [kN]		-	4,8	7,0	11,3	-	-	-	-
Shear V_{Rd}: single anchor, min. edge distance ($c = c_{min}$), without lever arm									
Non-cracked concrete									
HIT-V 5.8 [kN]		3,7	5,3	7,3	11,5	17,2	23,6	29,0	34,8
HIT-V 8.8 [kN]		3,7	5,3	7,3	11,5	17,2	23,6	29,0	34,8
HIT-V-R [kN]		3,7	5,3	7,3	11,5	17,2	23,6	29,0	34,8
HIT-V-HCR [kN]		3,7	5,3	7,3	11,5	17,2	23,6	29,0	34,8
Cracked concrete									
HIT-V 5.8 [kN]		-	3,8	5,2	8,1	-	-	-	-
HIT-V 8.8 [kN]		-	3,8	5,2	8,1	-	-	-	-
HIT-V-R [kN]		-	3,8	5,2	8,1	-	-	-	-
HIT-V-HCR [kN]		-	3,8	5,2	8,1	-	-	-	-

Design resistance: concrete C 20/25 – $f_{ck,cube} = 25 \text{ N/mm}^2$ - typical embedment depth
(load values are valid for single anchor)

Anchor size		M8	M10	M12	M16	M20	M24	M27	M30
Embedment depth $h_{ef} = h_{ef,typ}$ [mm]		80	90	110	125	170	210	240	270
Base material thickness $h = h_{min}$ [mm]		110	120	140	161	218	266	300	340
Spacing s [mm]		40	50	60	80	100	120	135	150
Tensile N_{Rd}: double anchor, no edge effects, min. spacing ($s = s_{min}$)									
Non-cracked concrete									
HIT-V 5.8									
HIT-V 8.8	[kN]	9,9	13,4	18,1	22,4	35,1	48,1	58,6	69,9
HIT-V-R									
HIT-V-HCR									
Cracked concrete									
HIT-V 5.8									
HIT-V 8.8	[kN]	-	5,9	8,6	12,8	-	-	-	-
HIT-V-R									
HIT-V-HCR									
Shear V_{Rd}: double anchor, no edge effects, min. spacing ($s = s_{min}$), without lever arm									
Non-cracked concrete									
HIT-V 5.8	[kN]	7,2	12,0	16,8	31,2	48,8	70,4	92,0	112,0
HIT-V 8.8	[kN]	12,0	18,4	27,2	45,7	72,4	100,5	120,9	140,7
HIT-V-R	[kN]	8,3	12,8	19,2	35,3	55,1	79,5	48,3	58,8
HIT-V-HCR	[kN]	12,0	18,4	27,2	45,7	72,4	70,9	92,0	112,0
Cracked concrete									
HIT-V 5.8	[kN]								
HIT-V 8.8	[kN]	-	12,0	16,8	28,0	-	-	-	-
HIT-V-R	[kN]								
HIT-V-HCR	[kN]								

Design resistance: concrete C 20/25 – $f_{ck,cube} = 25 \text{ N/mm}^2$ - embedment depth = $12 d^a$

Anchor size		M8	M10	M12	M16	M20	M24	M27	M30
Embedment depth $h_{ef} = 12 d^a$ [mm]		96	120	144	192	240	288	324	360
Base material thickness $h = h_{min}$ [mm]		126	150	174	228	288	344	384	430
Tensile N_{Rd}: single anchor, no edge effects									
Non-cracked concrete									
HIT-V 5.8	[kN]	12,0	19,3	28,0	52,7	82,0	118,0	152,7	160,2
HIT-V 8.8	[kN]	18,8	29,3	42,2	69,7	100,5	132,7	152,7	160,2
HIT-V-R	[kN]	13,9	21,9	31,6	58,8	92,0	132,1	80,4	98,3
HIT-V-HCR	[kN]	18,8	29,3	42,2	69,7	100,5	117,6	152,7	160,2
Cracked concrete									
HIT-V 5.8	[kN]								
HIT-V 8.8	[kN]	-	11,5	16,6	29,5	-	-	-	-
HIT-V-R	[kN]								
HIT-V-HCR	[kN]								
Shear V_{Rd}: single anchor, no edge effects, without lever arm									
Non-cracked concrete									
HIT-V 5.8	[kN]	7,2	12,0	16,8	31,2	48,8	70,4	92,0	112,0
HIT-V 8.8	[kN]	12,0	18,4	27,2	50,4	78,4	112,8	147,2	179,2
HIT-V-R	[kN]	8,3	12,8	19,2	35,3	55,1	79,5	48,3	58,8
HIT-V-HCR	[kN]	12,0	18,4	27,2	50,4	78,4	70,9	92,0	112,0
Cracked concrete									
HIT-V 5.8	[kN]	-	12,0	16,8	31,2	-	-	-	-
HIT-V 8.8	[kN]	-	18,4	27,2	50,4	-	-	-	-
HIT-V-R	[kN]	-	12,8	19,2	35,3	-	-	-	-
HIT-V-HCR	[kN]	-	18,4	27,2	50,4	-	-	-	-

a) d = element diameter

Design resistance: concrete C 20/25 – $f_{ck,cube} = 25 \text{ N/mm}^2$ - embedment depth = 12 d ^{a)}

Anchor size	M8	M10	M12	M16	M20	M24	M27	M30
Embedment depth $h_{ef} = 12 d$ ^{a)} [mm]	96	120	144	192	240	288	324	360
Base material thickness $h = h_{min}$ [mm]	126	150	174	228	288	344	384	430
Edge distance $c = c_{min}$ [mm]	40	50	60	80	100	120	135	150
Tensile N_{Rd}: single anchor, min. edge distance ($c = c_{min}$)								
Non-cracked concrete								
HIT-V 5.8 HIT-V 8.8 HIT-V-R HIT-V-HCR [kN]	10,4	16,2	21,7	33,4	46,7	61,3	73,2	85,7
Cracked concrete								
HIT-V 5.8 HIT-V 8.8 HIT-V-R HIT-V-HCR [kN]	-	6,4	9,2	16,6	-	-	-	-
Shear V_{Rd}: single anchor, min. edge distance ($c = c_{min}$), without lever arm								
Non-cracked concrete								
HIT-V 5.8 HIT-V 8.8 HIT-V-R HIT-V-HCR [kN]	3,9	5,7	7,8	12,9	18,9	25,9	31,8	38,1
Cracked concrete								
HIT-V 5.8 HIT-V 8.8 HIT-V-R HIT-V-HCR [kN]	-	4,0	5,5	9,1	-	-	-	-



a) d = element diameter

Design resistance: concrete C 20/25 – $f_{ck,cube} = 25 \text{ N/mm}^2$ - embedment depth = $12 d^a$
(load values are valid for single anchor)

Anchor size	M8	M10	M12	M16	M20	M24	M27	M30
Embedment depth $h_{ef} = 12 d^a$ [mm]	96	120	144	192	240	288	324	360
Base material thickness $h = h_{min}$ [mm]	126	150	174	228	288	344	384	430
Spacing $s = s_{min}$ [mm]	40	50	60	80	100	120	135	150
Tensile N_{Rd}: double anchor, no edge effects, min. spacing ($s = s_{min}$)								
Non-cracked concrete								
HIT-V 5.8 [kN]	12,0	18,5	26,0	40,8	57,0	74,9	89,4	103,8
HIT-V 8.8 [kN]	12,1	18,5	26,0	40,8	57,0	74,9	89,4	103,8
HIT-V-R [kN]	12,1	18,5	26,0	40,8	57,0	74,9	80,4	98,3
HIT-V-HCR [kN]	12,1	18,5	26,0	40,8	57,0	74,9	89,4	103,8
Cracked concrete								
HIT-V 5.8 [kN]								
HIT-V 8.8 [kN]	-	8,0	11,4	20,0	-	-	-	-
HIT-V-R [kN]								
HIT-V-HCR [kN]								
Shear V_{Rd}: double anchor, no edge effects, min. spacing ($s = s_{min}$), without lever arm								
Non-cracked concrete								
HIT-V 5.8 [kN]	7,2	12,0	16,8	31,2	48,8	70,4	92,0	112,0
HIT-V 8.8 [kN]	12,0	18,4	27,2	50,4	78,4	112,8	147,2	179,2
HIT-V-R [kN]	8,3	12,8	19,2	35,3	55,1	79,5	48,3	58,8
HIT-V-HCR [kN]	12,0	18,4	27,2	50,4	78,4	70,9	92,0	112,0
Cracked concrete								
HIT-V 5.8 [kN]	-	12,0	16,8	31,2	-	-	-	-
HIT-V 8.8 [kN]	-	15,7	22,7	40,3	-	-	-	-
HIT-V-R [kN]	-	12,8	19,2	35,3	-	-	-	-
HIT-V-HCR [kN]	-	15,7	22,7	40,3	-	-	-	-

a) d = element diameter

Hilti HIT-HY 100 mortar with HIS-(R)N sleeve

Injection mortar system		Benefits
	Hilti HIT-HY 100 500 ml foil pack (also available as 330 ml foil pack)	<ul style="list-style-type: none"> - suitable for non-cracked concrete C 20/25 to C 50/60 - suitable for dry and water saturated concrete - small edge distance and anchor spacing possible - corrosion resistant - in service temperature range up to 80°C short term/50°C long term - manual cleaning for drill hole sizes ≤ 18 mm
	Static mixer	
	Internal threaded sleeve HIS-N HIS-RN	



Concrete

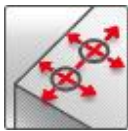

Small edge distance and spacing



Corrosion resistance



European Technical Approval



CE conformity

Approvals / certificates

Description	Authority / Laboratory	No. / date of issue
European Technical Approval ^{a)}	CSTB, Paris France	ETA-14/0009 / 2014-05-24

a) All data given in this section according ETA-14/0009 issue 2014-05-24.

Basic loading data (for a single anchor)

All data in this section applies to

- Correct setting (See setting instruction)
- No edge distance and spacing influence
- Steel failure
- Base material thickness, as specified in the table
- One anchor material, as specified in the tables
- Concrete C 20/25, $f_{ck,cube} = 25$ N/mm²
- Temperature range I
(min. base material temperature -40°C, max. long term/short term base material temperature: +24°C/40°C)
- Installation temperature range -10°C to +40°C

For details see Simplified design method

Embedment depth and base material thickness for the basic loading data.
Mean ultimate resistance, characteristic resistance, design resistance, recommended loads.

Anchor size		M8x90	M10x110	M12x125	M16x170	M20x205
Embedment depth	h_{ef} [mm]	90	110	125	170	205
Base material thickness	h [mm]	120	150	170	230	270

Mean ultimate resistance: non-cracked concrete C 20/25 , anchor HIS-N

Anchor size		M8x90	M10x110	M12x125	M16x170	M20x205
Tensile $N_{R_{u,m}}$	HIS-N [kN]	26,3	48,3	70,4	123,9	114,5
Shear $V_{R_{u,m}}$	HIS-N [kN]	13,7	24,2	41,0	62,0	57,8

Characteristic resistance: non-cracked concrete C 20/25 , anchor HIS-N

Anchor size		M8x90	M10x110	M12x125	M16x170	M20x205
Tensile N_{Rk}	HIS-N [kN]	25,0	46,0	67,0	95,0	109,0
Shear V_{Rk}	HIS-N [kN]	13,0	23,0	39,0	59,0	55,0

Design resistance: non-cracked concrete C 20/25 , anchor HIS-N

Anchor size		M8x90	M10x110	M12x125	M16x170	M20x205
Tensile N_{Rd}	HIS-N [kN]	17,5	27,8	39,2	52,8	63,9
Shear V_{Rd}	HIS-N [kN]	10,4	18,4	26,0	39,3	36,7

Recommended loads ^{a)}: non-cracked concrete C 20/25 , anchor HIS-N

Anchor size		M8x90	M10x110	M12x125	M16x170	M20x205
Tensile N_{rec}	HIS-N [kN]	12,5	19,8	28,0	37,7	45,6
Shear V_{rec}	HIS-N [kN]	7,4	13,1	18,6	28,1	26,2

a) With overall partial safety factor for action $\gamma = 1,4$. The partial safety factors for action depend on the type of loading and shall be taken from national regulations.

Service temperature range

Hilti HIT-HY 100 injection mortar may be applied in the temperature ranges given below. An elevated base material temperature may lead to a reduction of the design bond resistance.

Temperature range	Base material temperature	Maximum long term base material temperature	Maximum short term base material temperature
Temperature range I	-40 °C to +40 °C	+24 °C	+40 °C
Temperature range II	-40 °C to +80 °C	+50 °C	+80 °C

Max short term base material temperature

Short-term elevated base material temperatures are those that occur over brief intervals, e.g. as a result of diurnal cycling.

Max long term base material temperature

Long-term elevated base material temperatures are roughly constant over significant periods of time.

Materials

Mechanical properties of HIS-(R)N

Anchor size			M8x90	M10x110	M12x125	M16x170	M20x205
Nominal tensile strength f_{uk}	HIS-N	[N/mm ²]	490	490	460	460	460
	Screw 8.8	[N/mm ²]	800	800	800	800	800
	HIS-RN	[N/mm ²]	700	700	700	700	700
	Screw A4-70	[N/mm ²]	700	700	700	700	700
Yield strength f_{yk}	HIS-N	[N/mm ²]	410	410	375	375	375
	Screw 8.8	[N/mm ²]	640	640	640	640	640
	HIS-RN	[N/mm ²]	350	350	350	350	350
	Screw A4-70	[N/mm ²]	450	450	450	450	450
Stressed cross-section A_s	HIS-(R)N	[mm ²]	51,5	108,0	169,1	256,1	237,6
	Screw	[mm ²]	36,6	58	84,3	157	245
Moment of resistance W	HIS-(R)N	[mm ³]	145	430	840	1595	1543
	Screw	[mm ³]	31,2	62,3	109	277	541

Material quality

Part	Material
Internal threaded sleeve ^{a)} HIS-N	C-steel 1.0718, Steel galvanized $\geq 5\mu\text{m}$
Internal threaded sleeve ^{a)} HIS-RN	Stainless steel 1.4401 and 1.4571

- a) related fastening screw: strength class 8.8, A5 > 8% Ductile
steel galvanized $\geq 5\mu\text{m}$
- b) related fastening screw: strength class 70, A5 > 8% Ductile
stainless steel 1.4401; 1.4404; 1.4578; 1.4571; 1.4439; 1.4362

Anchor dimensions

Anchor size		M8x90	M10x110	M12x125	M16x170	M20x205
Internal threaded sleeve HIS-N / HIS-RN						
Embedment depth	h_{ef} [mm]	80	90	110	125	170

Setting

installation equipment

Anchor size	M8x90	M10x110	M12x125	M16x170	M20x205
Rotary hammer	TE 2 – TE 30		TE 40 – TE 70		
Other tools	compressed air gun or blow out pump, set of cleaning brushes, dispenser				

Setting instruction

Dry and water-saturated concrete, hammer drilling

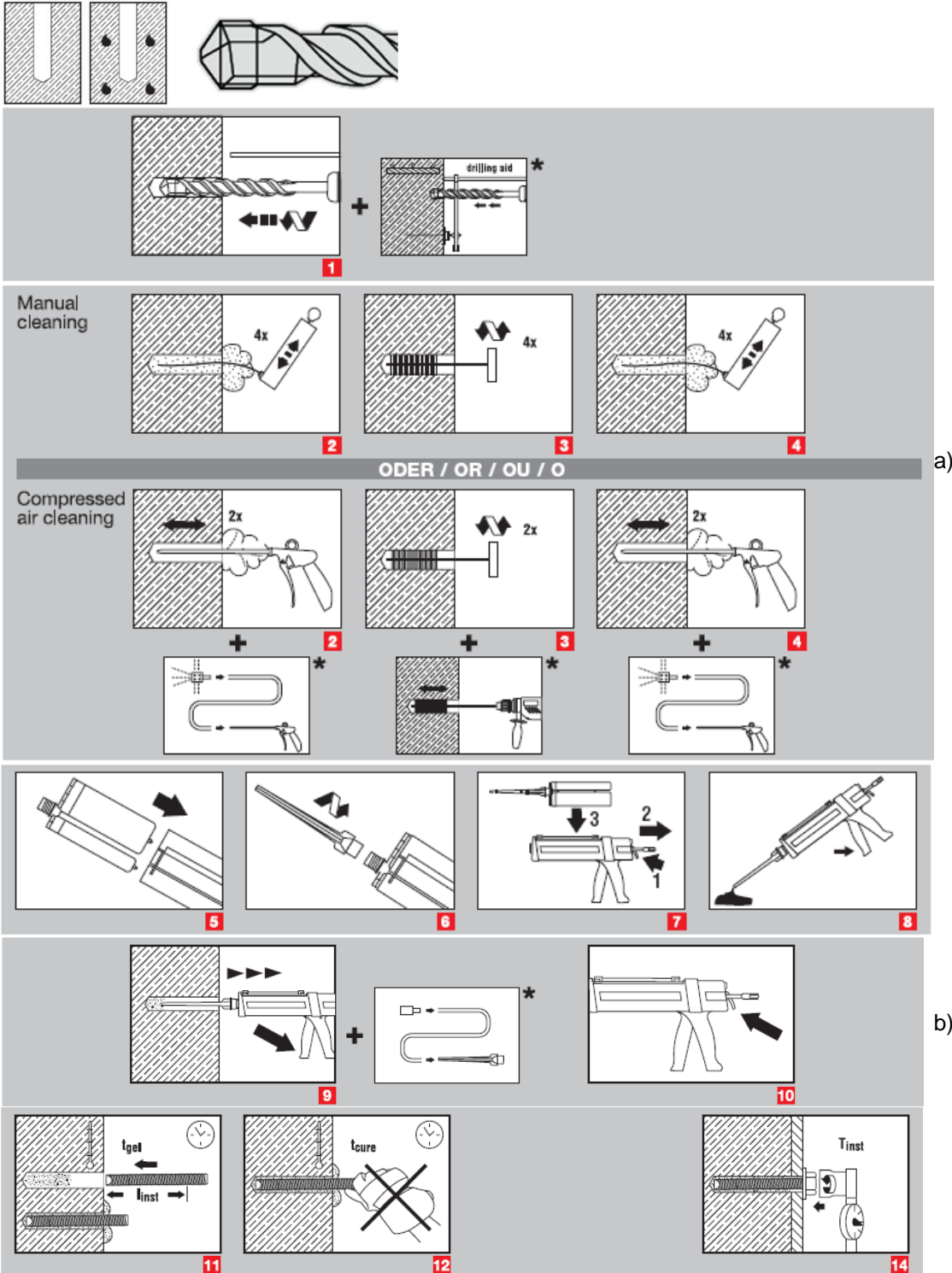

a) Note: Manual cleaning for drill hole sizes $d_0 \leq 18\text{mm}$ only!

Compressed air cleaning for all bore hole diameters and all bore hole depth

b) Note: Extension and piston plug needed for overhead installation!

For detailed information on installation see instruction for use given with the package of the product.

Working time, Curing time

Temperature of the base material T_{BM}	Working time t_{gel}	Curing time $t_{cure}^{a)}$
$-10\text{ °C} < T_{BM} < -6\text{ °C}$	180 min	12 h
$-5\text{ °C} < T_{BM} < -1\text{ °C}$	40 min	4 h
$0\text{ °C} < T_{BM} < +4\text{ °C}$	20 min	2 h
$+5\text{ °C} < T_{BM} < +9\text{ °C}$	8 min	1 h
$+10\text{ °C} < T_{BM} < +14\text{ °C}$	7 min	50 min
$+15\text{ °C} < T_{BM} < +19\text{ °C}$	6 min	40 min
$+20\text{ °C} < T_{BM} < +24\text{ °C}$	5 min	30 min
$+25\text{ °C} < T_{BM} < +29\text{ °C}$	3 min	30 min
$+30\text{ °C} < T_{BM} \leq +40\text{ °C}$	2 min	30 min

Setting details

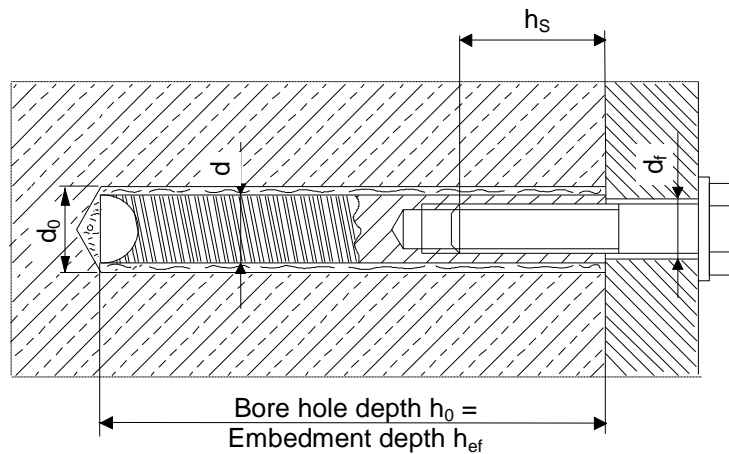

Anchor size			M8x90	M10x110	M12x125	M16x170	M20x205	
Nominal diameter of drill bit	d_0	[mm]	14	18	22	28	32	
Diameter of element	d	[mm]	12,5	16,5	20,5	25,4	27,6	
Effective anchorage and drill hole depth	h_{ef}	[mm]	90	110	125	170	205	
Minimum base material thickness	h_{min}	[mm]	120	150	170	230	270	
Diameter of clearance hole in the fixture	d_f	[mm]	9	12	14	18	22	
Thread engagement length; min - max	h_s	[mm]	8-20	10-25	12-30	16-40	20-50	
Torque moment ^{a)}	T_{max}	[Nm]	10	20	40	80	150	
Minimum spacing	s_{min}	[mm]	40	45	55	65	90	
Minimum edge distance	c_{min}	[mm]	40	45	55	65	90	
Critical spacing for splitting failure	$s_{cr,sp}$	[mm]	$2 c_{cr,sp}$					
Critical edge distance for splitting failure ^{b)}	$c_{cr,sp}$	[mm]	$1,0 \cdot h_{ef}$ for $h / h_{ef} \geq 2,0$					
			$4,6 h_{ef} - 1,8 h$ for $2,0 > h / h_{ef} > 1,3$					
			$2,26 h_{ef}$ for $h / h_{ef} \leq 1,3$					
Critical spacing for concrete cone failure	$s_{cr,N}$	[mm]	$2 c_{cr,N}$					
Critical edge distance for concrete cone failure ^{c)}	$c_{cr,N}$	[mm]	$1,5 h_{ef}$					

For spacing (or edge distance) smaller than critical spacing (or critical edge distance) the design loads have to be reduced.

- Maximum recommended torque moment to avoid splitting failure during installation with minimum spacing and/or edge distance.
- h : base material thickness ($h \geq h_{min}$), h_{ef} : embedment depth
- The critical edge distance for concrete cone failure depends on the embedment depth h_{ef} and the design bond resistance. The simplified formula given in this table is on the same side.

Simplified design method

Simplified version of the design method according ETAG 001, TR 029.

- Influence of concrete strength
- Influence of edge distance
- Influence of spacing
- Valid for a group of two anchors. (The method may also be applied for anchor groups with more than two anchors or more than one edge distance. The influencing factors must then be considered for each edge distance and spacing. The calculated design loads are then on the safe side: They will be lower than the exact values according ETAG 001, TR 029. To avoid this, it is recommended to use the anchor design software PROFIS anchor)

The design method is based on the following simplification:

- No different loads are acting on individual anchors (no eccentricity)

The values are valid for one anchor.

For more complex fastening applications please use the anchor design software PROFIS Anchor.

Tension loading

The design tensile resistance is the lower value of

- Steel resistance: $N_{Rd,s}$
- Combined pull-out and concrete cone resistance:
 $N_{Rd,p} = N_{Rd,p}^0 \cdot f_{B,p} \cdot f_{1,N} \cdot f_{2,N} \cdot f_{3,N} \cdot f_{h,p} \cdot f_{re,N}$
- Concrete cone resistance: $N_{Rd,c} = N_{Rd,c}^0 \cdot f_B \cdot f_{1,N} \cdot f_{2,N} \cdot f_{3,N} \cdot f_{h,N} \cdot f_{re,N}$
- Concrete splitting resistance (only non-cracked concrete):
 $N_{Rd,sp} = N_{Rd,c}^0 \cdot f_B \cdot f_{1,sp} \cdot f_{2,sp} \cdot f_{3,sp} \cdot f_{h,N} \cdot f_{re,N}$

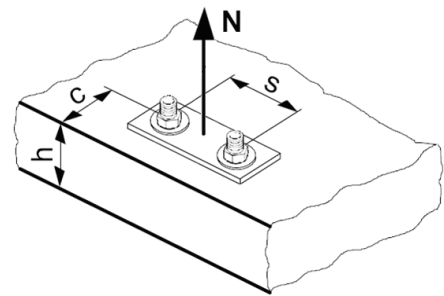

Basic design tensile resistance

Design steel resistance $N_{Rd,s}$

Anchor size			M8x90	M10x110	M12x125	M16x170	M20x205
$N_{Rd,s}$	HIS-N	[kN]	17,5	30,7	44,7	80,3	74,1
	HIS-RN	[kN]	13,9	21,9	31,6	58,8	69,2

Design combined pull-out and concrete cone resistance

$$N_{Rd,p} = N_{Rd,p}^0 \cdot f_{B,p} \cdot f_{1,N} \cdot f_{2,N} \cdot f_{3,N} \cdot f_{h,p} \cdot f_{re,N}$$

Anchor size			M8x90	M10x110	M12x125	M16x170	M20x205
Embedment depth	h_{ef}	[mm]	90	110	125	170	205
$N_{Rd,p}^0$	Temperature range I	[kN]	19,4	27,8	41,7	52,8	63,9
$N_{Rd,p}^0$	Temperature range II	[kN]	16,7	27,8	33,3	52,8	52,8

Design concrete cone resistance $N_{Rd,c} = N_{Rd,c}^0 \cdot f_B \cdot f_{1,N} \cdot f_{2,N} \cdot f_{3,N} \cdot f_{h,N} \cdot f_{re,N}$

Design splitting resistance $N_{Rd,sp} = N_{Rd,c}^0 \cdot f_B \cdot f_{1,sp} \cdot f_{2,sp} \cdot f_{3,sp} \cdot f_{h,N} \cdot f_{re,N}$

Anchor size			M8	M10	M12	M16	M20
$N_{Rd,c}^0$		[kN]	24,0	32,4	39,2	62,2	82,3

Influencing factors

Influence of concrete strength on combined pull-out and concrete cone resistance

Concrete strength designation (ENV 206)	C 20/25	C 25/30	C 30/37	C 35/45	C 40/50	C 45/55	C 50/60
$f_{B,p} = (f_{ck,cube}/25N/mm^2)^{0,15}$ ^{a)}	1,00	1,02	1,04	1,06	1,07	1,08	1,09

a) $f_{ck,cube}$ = concrete compressive strength, measured on cubes with 150 mm side length

Influence of embedment depth on combined pull-out and concrete cone resistance

$f_{h,p} = 1$

Influence of concrete strength on concrete cone resistance

Concrete strength designation (ENV 206)	C 20/25	C 25/30	C 30/37	C 35/45	C 40/50	C 45/55	C 50/60
$f_B = (f_{ck,cube}/25N/mm^2)^{0,5}$ ^{a)}	1	1,1	1,22	1,34	1,41	1,48	1,55

a) $f_{ck,cube}$ = concrete compressive strength, measured on cubes with 150 mm side length

Influence of edge distance ^{a)}

$c/c_{cr,N}$	0,1	0,2	0,3	0,4	0,5	0,6	0,7	0,8	0,9	1
$c/c_{cr,sp}$										
$f_{1,N} = 0,7 + 0,3 \cdot c/c_{cr,N} \leq 1$	0,73	0,76	0,79	0,82	0,85	0,88	0,91	0,94	0,97	1
$f_{1,sp} = 0,7 + 0,3 \cdot c/c_{cr,sp} \leq 1$										
$f_{2,N} = 0,5 \cdot (1 + c/c_{cr,N}) \leq 1$	0,55	0,60	0,65	0,70	0,75	0,80	0,85	0,90	0,95	1
$f_{2,sp} = 0,5 \cdot (1 + c/c_{cr,sp}) \leq 1$										

a) The edge distance shall not be smaller than the minimum edge distance c_{min} . These influencing factors must be considered for every edge distance smaller than the critical edge distance.

Influence of anchor spacing ^{a)}

$s/s_{cr,N}$	0,1	0,2	0,3	0,4	0,5	0,6	0,7	0,8	0,9	1
$s/s_{cr,sp}$										
$f_{3,N} = 0,5 \cdot (1 + s/s_{cr,N}) \leq 1$	0,55	0,60	0,65	0,70	0,75	0,80	0,85	0,90	0,95	1
$f_{3,sp} = 0,5 \cdot (1 + s/s_{cr,sp}) \leq 1$										

a) The anchor spacing shall not be smaller than the minimum anchor spacing s_{min} . This influencing factor must be considered for every anchor spacing.

Influence of embedment depth on concrete cone resistance

$f_{h,N} = 1$

Influence of reinforcement

h_{ef} [mm]	40	50	60	70	80	90	≥ 100
$f_{re,N} = 0,5 + h_{ef}/200mm \leq 1$	0,7 ^{a)}	0,75 ^{a)}	0,8 ^{a)}	0,85 ^{a)}	0,9 ^{a)}	0,95 ^{a)}	1

a) This factor applies only for dense reinforcement. If in the area of anchorage there is reinforcement with a spacing ≥ 150 mm (any diameter) or with a diameter ≤ 10 mm and a spacing ≥ 100 mm, then a factor $f_{re,N} = 1$ may be applied.

Shear loading

The design shear resistance is the lower value of

- Steel resistance: $V_{Rd,s}$
- Concrete pryout resistance: $V_{Rd,cp} = k \cdot \text{lower value of } N_{Rd,p} \text{ and } N_{Rd,c}$
- Concrete edge resistance: $V_{Rd,c} = V_{Rd,c}^0 \cdot f_B \cdot f_{\beta} \cdot f_h \cdot f_4 \cdot f_{hef} \cdot f_c$

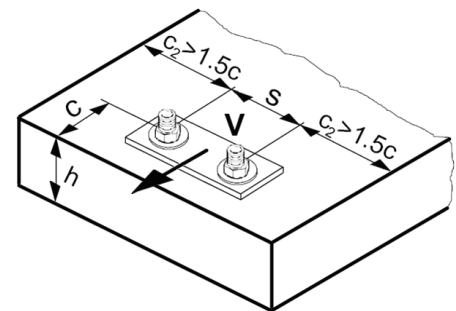

Basic design shear resistance

Design steel resistance $V_{Rd,s}$

Anchor size		M8x90	M10x110	M12x125	M16x170	M20x205
$V_{Rd,s}$	HIS-N [kN]	10,4	18,4	26,0	39,3	36,7
	HIS-RN [kN]	8,3	12,8	19,2	35,3	41,5

Design concrete pryout resistance $V_{Rd,cp} = \text{lower value}^a$ of $k \cdot N_{Rd,p}$ and $k \cdot N_{Rd,c}$

$$k = 2 \text{ for } h_{ef} \geq 60 \text{ mm}$$

- a) $N_{Rd,p}$: Design combined pull-out and concrete cone resistance
 $N_{Rd,c}$: Design concrete cone resistance

Design concrete edge resistance $V_{Rd,c} = V_{Rd,c}^0 \cdot f_B \cdot f_{\beta} \cdot f_h \cdot f_4 \cdot f_{hef} \cdot f_c$

Anchor size		M8	M10	M12	M16	M20
Non-cracked concrete						
$V_{Rd,c}^0$ [kN]		12,4	19,6	28,2	40,2	46,2

Influencing factors

Influence of concrete strength

Concrete strength designation (ENV 206)	C 20/25	C 25/30	C 30/37	C 35/45	C 40/50	C 45/55	C 50/60
$f_B = (f_{ck,cube}/25N/mm^2)^{1/2}$ a)	1	1,1	1,22	1,34	1,41	1,48	1,55

- a) $f_{ck,cube}$ = concrete compressive strength, measured on cubes with 150 mm side length

Influence of angle between load applied and the direction perpendicular to the free edge

Angle β	0°	10°	20°	30°	40°	50°	60°	70°	80°	≥ 90°
$f_{\beta} = \frac{1}{\sqrt{(\cos \alpha_V)^2 + \left(\frac{\sin \alpha_V}{2,5}\right)^2}}$	1	1,01	1,05	1,13	1,24	1,40	1,64	1,97	2,32	2,50

Influence of base material thickness

h/c	0,15	0,3	0,45	0,6	0,75	0,9	1,05	1,2	1,35	≥ 1,5
$f_h = \{h/(1,5 \cdot c)\}^{1/2} \leq 1$	0,32	0,45	0,55	0,63	0,71	0,77	0,84	0,89	0,95	1,00

Influence of anchor spacing and edge distance ^{a)} for concrete edge resistance: f_4
 $f_4 = (c/h_{ef})^{1,5} \cdot (1 + s / [3 \cdot c]) \cdot 0,5$

c/h _{ef}	Single anchor	Group of two anchors s/h _{ef}														
		0,75	1,50	2,25	3,00	3,75	4,50	5,25	6,00	6,75	7,50	8,25	9,00	9,75	10,50	11,25
0,50	0,35	0,27	0,35	0,35	0,35	0,35	0,35	0,35	0,35	0,35	0,35	0,35	0,35	0,35	0,35	0,35
0,75	0,65	0,43	0,54	0,65	0,65	0,65	0,65	0,65	0,65	0,65	0,65	0,65	0,65	0,65	0,65	0,65
1,00	1,00	0,63	0,75	0,88	1,00	1,00	1,00	1,00	1,00	1,00	1,00	1,00	1,00	1,00	1,00	1,00
1,25	1,40	0,84	0,98	1,12	1,26	1,40	1,40	1,40	1,40	1,40	1,40	1,40	1,40	1,40	1,40	1,40
1,50	1,84	1,07	1,22	1,38	1,53	1,68	1,84	1,84	1,84	1,84	1,84	1,84	1,84	1,84	1,84	1,84
1,75	2,32	1,32	1,49	1,65	1,82	1,98	2,15	2,32	2,32	2,32	2,32	2,32	2,32	2,32	2,32	2,32
2,00	2,83	1,59	1,77	1,94	2,12	2,30	2,47	2,65	2,83	2,83	2,83	2,83	2,83	2,83	2,83	2,83
2,25	3,38	1,88	2,06	2,25	2,44	2,63	2,81	3,00	3,19	3,38	3,38	3,38	3,38	3,38	3,38	3,38
2,50	3,95	2,17	2,37	2,57	2,77	2,96	3,16	3,36	3,56	3,76	3,95	3,95	3,95	3,95	3,95	3,95
2,75	4,56	2,49	2,69	2,90	3,11	3,32	3,52	3,73	3,94	4,15	4,35	4,56	4,56	4,56	4,56	4,56
3,00	5,20	2,81	3,03	3,25	3,46	3,68	3,90	4,11	4,33	4,55	4,76	4,98	5,20	5,20	5,20	5,20
3,25	5,86	3,15	3,38	3,61	3,83	4,06	4,28	4,51	4,73	4,96	5,18	5,41	5,63	5,86	5,86	5,86
3,50	6,55	3,51	3,74	3,98	4,21	4,44	4,68	4,91	5,14	5,38	5,61	5,85	6,08	6,31	6,55	6,55
3,75	7,26	3,87	4,12	4,36	4,60	4,84	5,08	5,33	5,57	5,81	6,05	6,29	6,54	6,78	7,02	7,26
4,00	8,00	4,25	4,50	4,75	5,00	5,25	5,50	5,75	6,00	6,25	6,50	6,75	7,00	7,25	7,50	7,75
4,25	8,76	4,64	4,90	5,15	5,41	5,67	5,93	6,18	6,44	6,70	6,96	7,22	7,47	7,73	7,99	8,25
4,50	9,55	5,04	5,30	5,57	5,83	6,10	6,36	6,63	6,89	7,16	7,42	7,69	7,95	8,22	8,49	8,75
4,75	10,35	5,45	5,72	5,99	6,27	6,54	6,81	7,08	7,36	7,63	7,90	8,17	8,45	8,72	8,99	9,26
5,00	11,18	5,87	6,15	6,43	6,71	6,99	7,27	7,55	7,83	8,11	8,39	8,66	8,94	9,22	9,50	9,78
5,25	12,03	6,30	6,59	6,87	7,16	7,45	7,73	8,02	8,31	8,59	8,88	9,17	9,45	9,74	10,02	10,31
5,50	12,90	6,74	7,04	7,33	7,62	7,92	8,21	8,50	8,79	9,09	9,38	9,67	9,97	10,26	10,55	10,85

a) The anchor spacing and the edge distance shall not be smaller than the minimum anchor spacing s_{min} and the minimum edge distance c_{min} .

Influence of embedment depth

Anchor size	M8	M10	M12	M16	M20
$f_{hef} =$	1,38	1,21	1,04	1,22	1,45

Influence of edge distance ^{a)}

c/d	4	6	8	10	15	20	30	40
$f_c = (d / c)^{0,19}$	0,77	0,71	0,67	0,65	0,60	0,57	0,52	0,50

a) The edge distance shall not be smaller than the minimum edge distance c_{min} .

Combined tension and shear loading

For combined tension and shear loading see section "Anchor Design".

Precalculated values – design resistance values

All data applies to:

- non-cracked concrete C 20/25 – $f_{ck,cube} = 25 \text{ N/mm}^2$
- temperature range I (see Service temperature range)
- minimum thickness of base material
- no effects of dense reinforcement

Recommended loads can be calculated by dividing the design resistance by an overall partial safety factor for action $\gamma = 1,4$. The partial safety factors for action depend on the type of loading and shall be taken from national regulations.

Design resistance: non-cracked- concrete C 20/25

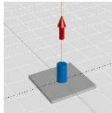
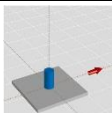
Anchor size		M8x90	M10x110	M12x125	M16x170	M20x205
Embedment depth	h_{ef} [mm]	90	110	125	170	205
Base material thickness	$h = h_{min}$ [mm]	120	150	170	230	270
	Tensile N_{Rd}: single anchor, no edge effects					
	HIS-N [kN]	17,5	27,8	39,2	52,8	63,9
	HIS-RN [kN]	13,9	21,9	31,6	52,8	63,9
	Shear V_{Rd}: single anchor, no edge effects, without lever arm					
	HIS-N [kN]	10,4	18,4	26,0	39,3	36,7
	HIS-RN [kN]	8,3	12,8	19,2	35,3	41,5

Design resistance: non-cracked- concrete C 20/25

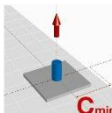
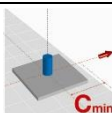
Anchor size		M8x90	M10x110	M12x125	M16x170	M20x205
Embedment depth	h_{ef} [mm]	90	110	125	170	205
Base material thickness	$h = h_{min}$ [mm]	120	150	170	230	270
Edge distance	$c = c_{min}$ [mm]	40	45	55	65	90
	Tensile N_{Rd}: single anchor, min. edge distance ($c = c_{min}$)					
	HIS-N [kN]	9,9	13,8	18,0	26,0	34,8
	HIS-RN [kN]	9,9	13,8	18,0	26,0	34,8
	Shear V_{Rd}: single anchor, min. edge distance ($c = c_{min}$), without lever arm					
	HIS-N [kN]	3,5	4,6	6,4	9,0	14,3
	HIS-RN [kN]	3,5	4,6	6,4	9,0	14,3

Design resistance: non-cracked- concrete C 20/25

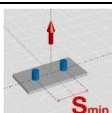
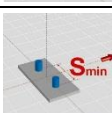
Anchor size		M8x90	M10x110	M12x125	M16x170	M20x205
Embedment depth	h_{ef} [mm]	90	110	125	170	205
Base material thickness	$h = h_{min}$ [mm]	120	150	170	230	270
Spacing	$s = s_{min}$ [mm]	40	45	55	65	90
	Tensile N_{Rd}: double anchor, no edge effects, min. spacing ($s = s_{min}$)					
	HIS-N [kN]	11,9	16,6	21,6	31,6	40,4
	HIS-RN [kN]					
	Shear V_{Rd}: double anchor, no edge effects, min. spacing ($s = s_{min}$), without lever arm					
	HIS-N [kN]	10,4	18,4	26,0	39,3	36,7
	HIS-RN [kN]	8,3	12,8	19,2	35,3	41,5

Hilti HIT-HY 100 mortar with rebar (as anchor)

Injection mortar system		Benefits
	Hilti HIT-HY 100 500 ml foil pack (also available as 330 ml foil pack)	<ul style="list-style-type: none"> - suitable for cracked and non-cracked concrete C 20/25 to C 50/60 - suitable for dry and water saturated concrete - small edge distance and anchor spacing possible - large diameter applications - in service temperature range up to 120°C short term/72°C long term - manual cleaning for drill hole sizes ≤ 18 mm and embedment depth $h_{ef} \leq 10d$ - embedment depth range $\varnothing 8$: 60 to 160 mm $\varnothing 25$: 120 to 500 mm
	Static mixer	
	rebar B500 B	



Concrete

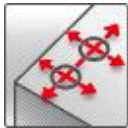

Small edge distance and spacing

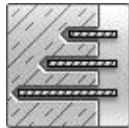

Variable embedment depth



European Technical Approval



CE conformity

Approvals / certificates

Description	Authority / Laboratory	No. / date of issue
European Technical Approval ^{a)}	CSTB, Paris	ETA-14/0009 / 2014-05-24

a) All data given in this section according ETA-14/0009 issue 2014-05-24.

Basic loading data (for a single anchor)

All data in this section applies to

For details see Simplified design method

- Correct setting (See setting instruction)
- No edge distance and spacing influence
- Steel failure
- Base material thickness, as specified in the table
- One typical embedment depth, as specified in the table
- Anchor material: rebar B500 B
- Concrete C 20/25, $f_{ck,cube} = 25$ N/mm²
- Temperature range I
(min. base material temperature -40°C, max. long term/short term base material temperature: +24°C/40°C)
- Installation temperature range -5°C to +40°C

Embedment depth ^{a)} and base material thickness for the basic loading data. Mean ultimate resistance, characteristic resistance, design resistance, recommended loads.

Anchor size	Ø8	Ø10	Ø12	Ø14	Ø16	Ø20	Ø25
Embedment depth $h_{ef} = h_{ef,typ}^b)$ [mm]	80	90	110	125	145	170	210
Base material thickness h [mm]	110	120	140	165	185	220	274

a) The allowed range of embedment depth is shown in the setting details. The corresponding load values can be calculated according to the simplified design method.

b) $h_{ef,typ}$: Typical embedment depth

Mean ultimate resistance: concrete C 20/25 , anchor B500 B

Anchor size	Ø8	Ø10	Ø12	Ø14	Ø16	Ø20	Ø25
Non-cracked concrete							
Tensile $N_{Ru,m}$ B500 B [kN]	25,4	35,7	52,3	69,3	91,9	134,7	204,0
Shear $V_{Ru,m}$ B500 B [kN]	14,7	23,1	32,6	44,1	57,8	90,3	141,8
Cracked concrete							
Tensile $N_{Ru,m}$ B500 B [kN]	-	20,6	30,3	40,1	38,7	-	-
Shear $V_{Ru,m}$ B500 B [kN]	-	23,1	32,6	44,1	57,8	-	-

Characteristic resistance: concrete C 20/25 , anchor B500 B

Anchor size	Ø8	Ø10	Ø12	Ø14	Ø16	Ø20	Ø25
Non-cracked concrete							
Tensile N_{Rk} B500 B [kN]	19,1	26,9	39,4	52,2	69,2	101,5	153,7
Shear V_{Rk} B500 B [kN]	14,0	22,0	31,0	42,0	55,0	86,0	135,0
Cracked concrete							
Tensile N_{Rk} B500 B [kN]	-	15,6	22,8	30,2	29,2	-	-
Shear V_{Rk} B500 B [kN]	-	22,0	31,0	42,0	55,0	-	-

Design resistance: concrete C 20/25 , anchor B500 B

Anchor size	Ø8	Ø10	Ø12	Ø14	Ø16	Ø20	Ø25
Non-cracked concrete							
Tensile N_{Rd} B500 B [kN]	10,6	14,9	21,9	29,0	38,5	56,4	85,4
Shear V_{Rd} B500 B [kN]	9,3	14,7	20,7	28,0	36,7	57,3	90,0
Cracked concrete							
Tensile N_{Rd} B500 B [kN]	-	8,6	12,7	16,8	16,2	-	-
Shear V_{Rd} B500 B [kN]	-	14,7	20,7	28,0	36,7	-	-

Recommended loads ^{a)}: concrete C 20/25 , anchor B500 B

Anchor size	Ø8	Ø10	Ø12	Ø14	Ø16	Ø20	Ø25
Non-cracked concrete							
Tensile N_{rec} B500 B [kN]	7,6	10,7	15,6	20,7	27,5	40,3	61,0
Shear V_{rec} B500 B [kN]	6,7	10,5	14,8	20,0	26,2	41,0	64,3
Cracked concrete							
Tensile N_{rec} B500 B [kN]	-	6,2	9,1	12,0	11,6	-	-
Shear V_{rec} B500 B [kN]	-	10,5	14,8	20,0	26,2	-	-

a) With overall partial safety factor for action $\gamma = 1,4$. The partial safety factors for action depend on the type of loading and shall be taken from national regulations.

Service temperature range

Hilti HIT-HY 100 injection mortar may be applied in the temperature ranges given below. An elevated base material temperature may lead to a reduction of the design bond resistance.

Temperature range	Base material temperature	Maximum long term base material temperature	Maximum short term base material temperature
Temperature range I	-40 °C to +40 °C	+24 °C	+40 °C
Temperature range II	-40 °C to +80 °C	+50 °C	+80 °C

Max short term base material temperature

Short-term elevated base material temperatures are those that occur over brief intervals, e.g. as a result of diurnal cycling.

Max long term base material temperature

Long-term elevated base material temperatures are roughly constant over significant periods of time.

Materials

Mechanical properties of rebar B500 B

Anchor size	Ø8	Ø10	Ø12	Ø14	Ø16	Ø20	Ø25
Nominal tensile strength f_{uk} B500 B [N/mm ²]	550						
Yield strength f_{yk} B500 B [N/mm ²]	500						
Stressed cross-section A_s B500 B [mm ²]	50,3	78,5	113,1	153,9	201,1	314,2	490,9
Moment of resistance W B500 B [mm ³]	50,3	98,2	169,6	269,4	402,1	785,4	1534

Material quality

Part	Material
rebar B500 B	EN 1992-1-1:2004 and AC:2010, Annex C Bars and de-coiled rods Class B or C with f_{yk} and k according to NDP or NCL of EN 1992-1-1/NA:2013

Anchor dimensions

Anchor size	Ø8	Ø10	Ø12	Ø14	Ø16	Ø20	Ø25
rebar B500 B	rebar are available in variable length						

Setting

installation equipment

Anchor size	Ø8	Ø10	Ø12	Ø14	Ø16	Ø20	Ø25
Rotary hammer	TE 2 – TE 30					TE 40 – TE 70	
Other tools	compressed air gun or blow out pump, set of cleaning brushes, dispenser						

Setting instruction

Dry and water-saturated concrete, hammer drilling

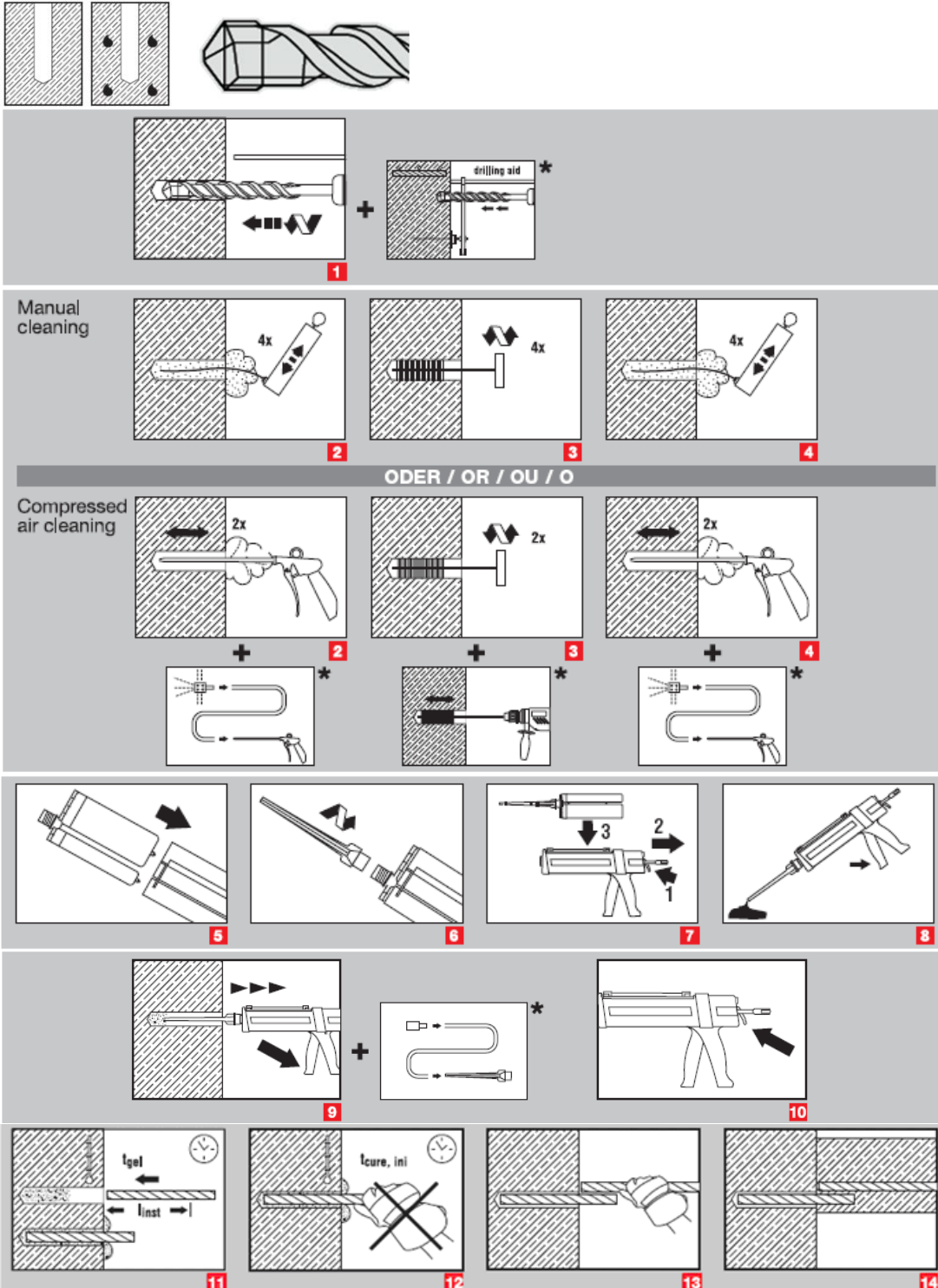

a)

b)

a) Note: Manual cleaning for drill hole sizes $d_0 \leq 18\text{mm}$ and embedment depth $h_{ef} \leq 10 d$ only!

Manual cleaning for uncracked concrete only!

Compressed air cleaning for all bore hole diameters and all bore hole depth

b) Note: Extension and piston plug needed for overhead installation and/or embedment depth $> 250\text{mm}$!

For detailed information on installation see instruction for use given with the package of the product.

Working time, Curing time

Temperature of the base material T_{BM}	Working time t_{gel}	Curing time $t_{cure}^{a)}$
-5 °C to -1 °C	90 min	9 h
0 °C to 4 °C	45 min	4,5 h
5 °C to 9 °C	20 min	2 h
10 °C to 19 °C	6 min	90 min
20 °C to 29 °C	4 min	50 min
30 °C to 40 °C	2 min	41 min

a) The curing time data are valid for dry anchorage base only. For water saturated anchorage bases the curing times must be doubled.

Setting details

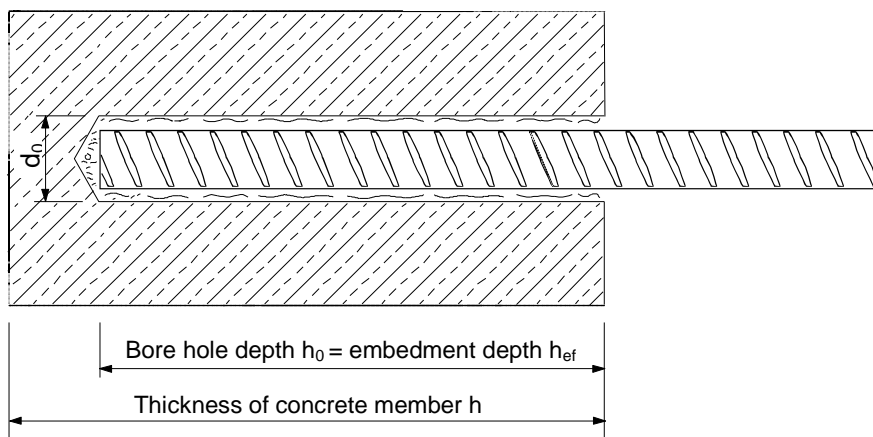

Anchor size			Ø8	Ø10	Ø12	Ø14	Ø16	Ø20	Ø25
Nominal diameter of drill bit	d_0	[mm]	12	14	16	18	20	25	32
Effective embedment and drill hole depth range ^{a)} for rebar B500 B	$h_{ef,min}$	[mm]	60	60	70	80	80	90	100
	$h_{ef,max}$	[mm]	160	200	240	280	320	400	500
Minimum base material thickness	h_{min}	[mm]	$h_{ef} + 30$ mm			$h_{ef} + 2 d_0$			
Minimum spacing	s_{min}	[mm]	40	50	60	70	80	100	125
Minimum edge distance	c_{min}	[mm]	40	50	60	70	80	100	125
Critical spacing for splitting failure	$s_{cr,sp}$	[mm]	$2 c_{cr,sp}$						
Critical edge distance for splitting failure ^{b)}	$c_{cr,sp}$	[mm]	$1,0 \cdot h_{ef}$		for $h / h_{ef} \geq 2,0$				
			$4,6 h_{ef} - 1,8 h$		for $2,0 > h / h_{ef} > 1,3$				
			$2,26 h_{ef}$		for $h / h_{ef} \leq 1,3$				
Critical spacing for concrete cone failure	$s_{cr,N}$	[mm]	$2 c_{cr,N}$						
Critical edge distance for concrete cone failure ^{c)}	$c_{cr,N}$	[mm]	$1,5 h_{ef}$						

For spacing (or edge distance) smaller than critical spacing (or critical edge distance) the design loads have to be reduced.

- a) Embedment depth range: $h_{ef,min} \leq h_{ef} \leq h_{ef,max}$
- b) h : base material thickness ($h \geq h_{min}$), h_{ef} : embedment depth
- c) The critical edge distance for concrete cone failure depends on the embedment depth h_{ef} and the design bond resistance. The simplified formula given in this table is on the safe side.

Simplified design method

Simplified version of the design method according ETAG 001, TR 029.

- Influence of concrete strength
- Influence of edge distance
- Influence of spacing
- Valid for a group of two anchors. (The method may also be applied for anchor groups with more than two anchors or more than one edge distance. The influencing factors must then be considered for each edge distance and spacing. The calculated design loads are then on the save side: They will be lower than the exact values according ETAG 001, TR 029. To avoid this, it is recommended to use the anchor design software PROFIS anchor)

The design method is based on the following simplification:

- No different loads are acting on individual anchors (no eccentricity)

The values are valid for one anchor.

For more complex fastening applications please use the anchor design software PROFIS Anchor.

Tension loading

The design tensile resistance is the lower value of

- Steel resistance: $N_{Rd,s}$
- Combined pull-out and concrete cone resistance: $N_{Rd,p} = N_{Rd,p}^0 \cdot f_{B,p} \cdot f_{1,N} \cdot f_{2,N} \cdot f_{3,N} \cdot f_{h,p} \cdot f_{re,N}$
- Concrete cone resistance: $N_{Rd,c} = N_{Rd,c}^0 \cdot f_B \cdot f_{1,N} \cdot f_{2,N} \cdot f_{3,N} \cdot f_{h,N} \cdot f_{re,N}$
- Concrete splitting resistance (only non-cracked concrete): $N_{Rd,sp} = N_{Rd,c}^0 \cdot f_B \cdot f_{1,sp} \cdot f_{2,sp} \cdot f_{3,sp} \cdot f_{h,N} \cdot f_{re,N}$

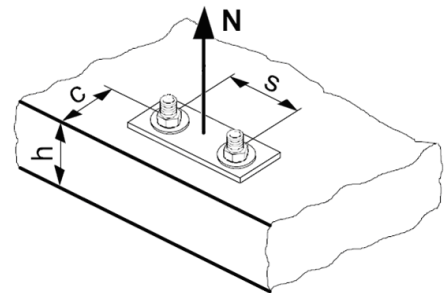

Basic design tensile resistance

Design steel resistance $N_{Rd,s}$

Anchor size		Ø8	Ø10	Ø12	Ø14	Ø16	Ø20	Ø25
$N_{Rd,s}$ B500 B	[kN]	20,0	30,7	44,3	60,7	79,3	123,6	192,9

Design combined pull-out and concrete cone resistance

$$N_{Rd,p} = N_{Rd,p}^0 \cdot f_{B,p} \cdot f_{1,N} \cdot f_{2,N} \cdot f_{3,N} \cdot f_{h,p} \cdot f_{re,N}$$

Anchor size		Ø8	Ø10	Ø12	Ø14	Ø16	Ø20	Ø25
Embedment depth $h_{ef} =$ Typical embedment depth $h_{ef,typ}$	[mm]	80	90	110	125	145	170	210
Non-cracked concrete								
$N_{Rd,p}^0$ Temperature range I	[kN]	10,6	14,9	21,9	29,0	38,5	56,4	87,0
$N_{Rd,p}^0$ Temperature range II	[kN]	8,9	12,6	18,4	24,4	32,4	47,5	73,3
Cracked concrete								
$N_{Rd,p}^0$ Temperature range I	[kN]	-	8,6	12,7	16,8	22,3	-	-
$N_{Rd,p}^0$ Temperature range II	[kN]	-	6,3	9,2	12,2	16,2	-	-

Design concrete cone resistance $N_{Rd,c} = N_{Rd,c}^0 \cdot f_B \cdot f_{1,N} \cdot f_{2,N} \cdot f_{3,N} \cdot f_{h,N} \cdot f_{re,N}$

Design splitting resistance $N_{Rd,sp} = N_{Rd,c}^0 \cdot f_B \cdot f_{1,sp} \cdot f_{2,sp} \cdot f_{3,sp} \cdot f_{h,N} \cdot f_{re,N}$

Anchor size		Ø8	Ø10	Ø12	Ø14	Ø16	Ø20	Ø25
$N_{Rd,c}^0$ Non-cracked concrete [kN]		20,1	24,0	32,4	39,2	49,0	62,2	85,4
$N_{Rd,c}^0$ Cracked concrete [kN]		-	17,1	23,1	28,0	34,9	-	-

Influencing factors

Influence of concrete strength on combined pull-out and concrete cone resistance

Concrete strength designation (ENV 206)	C 20/25	C 25/30	C 30/37	C 35/45	C 40/50	C 45/55	C 50/60
$f_{B,p} = (f_{ck,cube}/25N/mm^2)^{0,15}$ a)	1,00	1,02	1,04	1,06	1,07	1,08	1,09

a) $f_{ck,cube}$ = concrete compressive strength, measured on cubes with 150 mm side length

Influence of embedment depth on combined pull-out and concrete cone resistance

$f_{h,p} = h_{ef}/h_{ef,typ}$

Influence of concrete strength on concrete cone resistance

Concrete strength designation (ENV 206)	C 20/25	C 25/30	C 30/37	C 35/45	C 40/50	C 45/55	C 50/60
$f_B = (f_{ck,cube}/25N/mm^2)^{0,5}$ a)	1	1,1	1,22	1,34	1,41	1,48	1,55

a) $f_{ck,cube}$ = concrete compressive strength, measured on cubes with 150 mm side length

Influence of edge distance a)

$c/c_{cr,N}$	0,1	0,2	0,3	0,4	0,5	0,6	0,7	0,8	0,9	1
$c/c_{cr,sp}$										
$f_{1,N} = 0,7 + 0,3 \cdot c/c_{cr,N} \leq 1$	0,73	0,76	0,79	0,82	0,85	0,88	0,91	0,94	0,97	1
$f_{1,sp} = 0,7 + 0,3 \cdot c/c_{cr,sp} \leq 1$										
$f_{2,N} = 0,5 \cdot (1 + c/c_{cr,N}) \leq 1$	0,55	0,60	0,65	0,70	0,75	0,80	0,85	0,90	0,95	1
$f_{2,sp} = 0,5 \cdot (1 + c/c_{cr,sp}) \leq 1$										

a) The edge distance shall not be smaller than the minimum edge distance c_{min} . These influencing factors must be considered for every edge distance smaller than the critical edge distance.

Influence of anchor spacing a)

$s/s_{cr,N}$	0,1	0,2	0,3	0,4	0,5	0,6	0,7	0,8	0,9	1
$s/s_{cr,sp}$										
$f_{3,N} = 0,5 \cdot (1 + s/s_{cr,N}) \leq 1$	0,55	0,60	0,65	0,70	0,75	0,80	0,85	0,90	0,95	1
$f_{3,sp} = 0,5 \cdot (1 + s/s_{cr,sp}) \leq 1$										

a) The anchor spacing shall not be smaller than the minimum anchor spacing s_{min} . This influencing factor must be considered for every anchor spacing.

Influence of embedment depth on concrete cone resistance

$f_{h,N} = (h_{ef}/h_{ef,typ})^{1,5}$

Influence of reinforcement

h_{ef} [mm]	40	50	60	70	80	90	≥ 100
$f_{re,N} = 0,5 + h_{ef}/200\text{mm} \leq 1$	0,7 ^{a)}	0,75 ^{a)}	0,8 ^{a)}	0,85 ^{a)}	0,9 ^{a)}	0,95 ^{a)}	1

a) This factor applies only for dense reinforcement. If in the area of anchorage there is reinforcement with a spacing ≥ 150 mm (any diameter) or with a diameter ≤ 10 mm and a spacing ≥ 100 mm, then a factor $f_{re,N} = 1$ may be applied.

Shear loading

The design shear resistance is the lower value of

- Steel resistance: $V_{Rd,s}$
- Concrete pryout resistance: $V_{Rd,cp} = k \cdot \text{lower value of } N_{Rd,p} \text{ and } N_{Rd,c}$
- Concrete edge resistance: $V_{Rd,c} = V_{Rd,c}^0 \cdot f_B \cdot f_{\beta} \cdot f_h \cdot f_4 \cdot f_{hef} \cdot f_c$

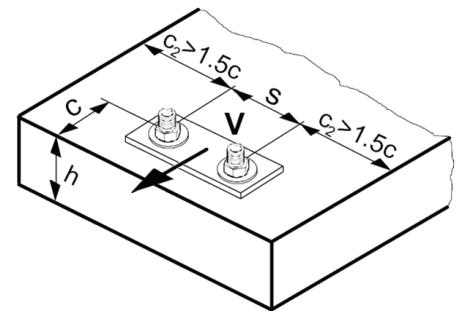

Basic design shear resistance

Design steel resistance $V_{Rd,s}$

Anchor size	$\emptyset 8$	$\emptyset 10$	$\emptyset 12$	$\emptyset 14$	$\emptyset 16$	$\emptyset 20$	$\emptyset 25$
$V_{Rd,s}$ Rebar B500 B [kN]	9,3	14,7	20,7	28,0	36,7	57,3	90,0

Design concrete pryout resistance $V_{Rd,cp} = \text{lower value}^a)$ of $k \cdot N_{Rd,p}$ and $k \cdot N_{Rd,c}$

$$k = 2 \text{ for } h_{ef} \geq 60 \text{ mm}$$

- a) $N_{Rd,p}$: Design combined pull-out and concrete cone resistance
 $N_{Rd,c}$: Design concrete cone resistance

Design concrete edge resistance $V_{Rd,c} = V_{Rd,c}^0 \cdot f_B \cdot f_{\beta} \cdot f_h \cdot f_4 \cdot f_{hef} \cdot f_c$

Anchor size	$\emptyset 8$	$\emptyset 10$	$\emptyset 12$	$\emptyset 14$	$\emptyset 16$	$\emptyset 20$	$\emptyset 25$
Non-cracked concrete							
$V_{Rd,c}^0$ [kN]	5,9	8,6	11,6	15,0	18,7	27,0	39,2
Cracked concrete							
$V_{Rd,c}^0$ [kN]	-	6,1	8,2	10,6	13,2	-	-

Influencing factors

Influence of concrete strength

Concrete strength designation (ENV 206)	C 20/25	C 25/30	C 30/37	C 35/45	C 40/50	C 45/55	C 50/60
$f_B = (f_{ck,cube}/25\text{N/mm}^2)^{1/2}$ a)	1	1,1	1,22	1,34	1,41	1,48	1,55

- a) $f_{ck,cube}$ = concrete compressive strength, measured on cubes with 150 mm side length

Influence of angle between load applied and the direction perpendicular to the free edge

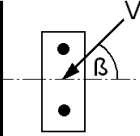
Angle β	0°	10°	20°	30°	40°	50°	60°	70°	80°	≥ 90°
$f_{\beta} = \frac{1}{\sqrt{(\cos \alpha_v)^2 + \left(\frac{\sin \alpha_v}{2,5}\right)^2}}$ 	1	1,01	1,05	1,13	1,24	1,40	1,64	1,97	2,32	2,50

Influence of base material thickness

h/c	0,15	0,3	0,45	0,6	0,75	0,9	1,05	1,2	1,35	≥ 1,5
$f_h = \{h/(1,5 \cdot c)\}^{1/2} \leq 1$	0,32	0,45	0,55	0,63	0,71	0,77	0,84	0,89	0,95	1,00

Influence of anchor spacing and edge distance ^{a)} for concrete edge resistance: f_4

$$f_4 = (c/h_{ef})^{1,5} \cdot (1 + s / [3 \cdot c]) \cdot 0,5$$

c/h _{ef}	Single anchor	Group of two anchors s/h _{ef}														
		0,75	1,50	2,25	3,00	3,75	4,50	5,25	6,00	6,75	7,50	8,25	9,00	9,75	10,50	11,25
0,50	0,35	0,27	0,35	0,35	0,35	0,35	0,35	0,35	0,35	0,35	0,35	0,35	0,35	0,35	0,35	0,35
0,75	0,65	0,43	0,54	0,65	0,65	0,65	0,65	0,65	0,65	0,65	0,65	0,65	0,65	0,65	0,65	0,65
1,00	1,00	0,63	0,75	0,88	1,00	1,00	1,00	1,00	1,00	1,00	1,00	1,00	1,00	1,00	1,00	1,00
1,25	1,40	0,84	0,98	1,12	1,26	1,40	1,40	1,40	1,40	1,40	1,40	1,40	1,40	1,40	1,40	1,40
1,50	1,84	1,07	1,22	1,38	1,53	1,68	1,84	1,84	1,84	1,84	1,84	1,84	1,84	1,84	1,84	1,84
1,75	2,32	1,32	1,49	1,65	1,82	1,98	2,15	2,32	2,32	2,32	2,32	2,32	2,32	2,32	2,32	2,32
2,00	2,83	1,59	1,77	1,94	2,12	2,30	2,47	2,65	2,83	2,83	2,83	2,83	2,83	2,83	2,83	2,83
2,25	3,38	1,88	2,06	2,25	2,44	2,63	2,81	3,00	3,19	3,38	3,38	3,38	3,38	3,38	3,38	3,38
2,50	3,95	2,17	2,37	2,57	2,77	2,96	3,16	3,36	3,56	3,76	3,95	3,95	3,95	3,95	3,95	3,95
2,75	4,56	2,49	2,69	2,90	3,11	3,32	3,52	3,73	3,94	4,15	4,35	4,56	4,56	4,56	4,56	4,56
3,00	5,20	2,81	3,03	3,25	3,46	3,68	3,90	4,11	4,33	4,55	4,76	4,98	5,20	5,20	5,20	5,20
3,25	5,86	3,15	3,38	3,61	3,83	4,06	4,28	4,51	4,73	4,96	5,18	5,41	5,63	5,86	5,86	5,86
3,50	6,55	3,51	3,74	3,98	4,21	4,44	4,68	4,91	5,14	5,38	5,61	5,85	6,08	6,31	6,55	6,55
3,75	7,26	3,87	4,12	4,36	4,60	4,84	5,08	5,33	5,57	5,81	6,05	6,29	6,54	6,78	7,02	7,26
4,00	8,00	4,25	4,50	4,75	5,00	5,25	5,50	5,75	6,00	6,25	6,50	6,75	7,00	7,25	7,50	7,75
4,25	8,76	4,64	4,90	5,15	5,41	5,67	5,93	6,18	6,44	6,70	6,96	7,22	7,47	7,73	7,99	8,25
4,50	9,55	5,04	5,30	5,57	5,83	6,10	6,36	6,63	6,89	7,16	7,42	7,69	7,95	8,22	8,49	8,75
4,75	10,35	5,45	5,72	5,99	6,27	6,54	6,81	7,08	7,36	7,63	7,90	8,17	8,45	8,72	8,99	9,26
5,00	11,18	5,87	6,15	6,43	6,71	6,99	7,27	7,55	7,83	8,11	8,39	8,66	8,94	9,22	9,50	9,78
5,25	12,03	6,30	6,59	6,87	7,16	7,45	7,73	8,02	8,31	8,59	8,88	9,17	9,45	9,74	10,02	10,31
5,50	12,90	6,74	7,04	7,33	7,62	7,92	8,21	8,50	8,79	9,09	9,38	9,67	9,97	10,26	10,55	10,85

a) The anchor spacing and the edge distance shall not be smaller than the minimum anchor spacing s_{min} and the minimum edge distance c_{min} .

Influence of embedment depth

h _{ef} /d	4	4,5	5	6	7	8	9	10	11
$f_{hef} = 0,05 \cdot (h_{ef} / d)^{1,68}$	0,51	0,63	0,75	1,01	1,31	1,64	2,00	2,39	2,81
h _{ef} /d	12	13	14	15	16	17	18	19	20
$f_{hef} = 0,05 \cdot (h_{ef} / d)^{1,68}$	3,25	3,72	4,21	4,73	5,27	5,84	6,42	7,04	7,67

Influence of edge distance ^{a)}

c/d	4	6	8	10	15	20	30	40
$f_c = (d / c)^{0,19}$	0,77	0,71	0,67	0,65	0,60	0,57	0,52	0,50

a) The edge distance shall not be smaller than the minimum edge distance c_{min} .

Combined tension and shear loading

For combined tension and shear loading see section “Anchor Design”.

Precalculated values – design resistance values

All data applies to:

- non-cracked concrete C 20/25 – $f_{ck,cube} = 25 \text{ N/mm}^2$
- temperature range I (see Service temperature range)
- minimum thickness of base material
- no effects of dense reinforcement

Recommended loads can be calculated by dividing the design resistance by an overall partial safety factor for action $\gamma = 1,4$. The partial safety factors for action depend on the type of loading and shall be taken from national regulations.

Design resistance: concrete C 20/25 - minimum embedment depth

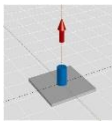
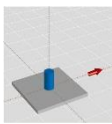
Anchor size		Ø8	Ø10	Ø12	Ø14	Ø16	Ø20	Ø25
Embedment depth $h_{ef} = h_{ef,min}$ [mm]		60	60	70	80	80	90	100
Base material thickness $h = h_{min}$ [mm]		90	90	100	116	120	140	164
	Tensile N_{Rd}: single anchor, no edge effects							
	Non-cracked concrete							
	B500 B [kN]	8,0	9,9	13,9	18,6	20,1	24,0	28,1
	Cracked concrete							
B500 B [kN]	-	5,8	8,1	10,8	12,3	-	-	
	Shear V_{Rd}: single anchor, no edge effects, without lever arm							
	Non-cracked concrete							
	B500 B [kN]	9,3	14,7	20,7	28,0	36,7	57,3	67,3
	Cracked concrete							
B500 B [kN]	-	13,8	19,4	25,8	29,5	-	-	

Design resistance: concrete C 20/25 - minimum embedment depth

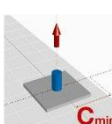
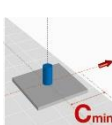
Anchor size		Ø8	Ø10	Ø12	Ø14	Ø16	Ø20	Ø25
Embedment depth $h_{ef} = h_{ef,min}$ [mm]		60	60	70	80	80	90	100
Base material thickness $h = h_{min}$ [mm]		90	90	100	116	120	140	164
Edge distance $c = c_{min}$ [mm]		40	50	60	70	80	100	125
	Tensile N_{Rd}: single anchor, min. edge distance ($c = c_{min}$)							
	Non-cracked concrete							
	B500 B [kN]	4,8	6,7	9,5	12,0	13,1	17,1	22,9
	Cracked concrete							
B500 B [kN]	-	3,9	5,5	7,4	9,2	-	-	
	Shear V_{Rd}: single anchor, min. edge distance ($c = c_{min}$), without lever arm							
	Non-cracked concrete							
	B500 B [kN]	3,5	4,9	6,6	8,5	10,4	14,2	19,5
	Cracked concrete							
B500 B [kN]	-	3,5	4,7	6,0	7,4	-	-	

Design resistance: concrete C 20/25 - minimum embedment depth (load values are valid for single anchor)

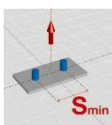
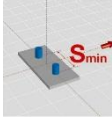
Anchor size		Ø8	Ø10	Ø12	Ø14	Ø16	Ø20	Ø25
Embedment depth	$h_{ef} = h_{ef,min}$ [mm]	60	60	70	80	80	90	100
Base material thickness	$h = h_{min}$ [mm]	90	90	100	116	120	140	164
Spacing	$s = s_{min}$ [mm]	40	50	60	70	80	100	125
	Tensile N_{Rd}: double anchor, no edge effects, min. spacing ($s = s_{min}$)							
	Non-cracked concrete							
	B500 B [kN]	5,4	6,8	9,3	12,2	12,7	15,7	19,3
	Cracked concrete							
B500 B [kN]	-	4,1	5,6	7,4	8,5	-	-	
	Shear V_{Rd}: double anchor, no edge effects, min. spacing ($s = s_{min}$), without lever arm							
	Non-cracked concrete							
	B500 B [kN]	9,3	14,7	20,7	28,0	32,1	39,4	47,7
	Cracked concrete							
B500 B [kN]	-	8,8	12,4	16,7	19,7	-	-	

Design resistance: concrete C 20/25 - typical embedment depth

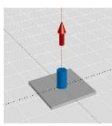
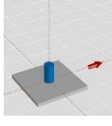
Anchor size		Ø8	Ø10	Ø12	Ø14	Ø16	Ø20	Ø25
Embedment depth	$h_{ef} = h_{ef,typ}$ [mm]	80	90	110	125	145	170	210
Base material thickness	$h = h_{min}$ [mm]	110	120	142	161	185	220	274
	Tensile N_{Rd}: single anchor, no edge effects							
	Non-cracked concrete							
	B500 B [kN]	10,6	14,9	21,9	29,0	38,5	56,4	85,4
	Cracked concrete							
B500 B [kN]	-	8,6	12,7	16,8	22,3	-	-	
	Shear V_{Rd}: single anchor, no edge effects, without lever arm							
	Non-cracked concrete							
	B500 B [kN]	9,3	14,7	20,7	28,0	36,7	57,3	90,0
	Cracked concrete							
B500 B [kN]	-	14,7	20,7	28,0	36,7	-	-	

Design resistance: concrete C 20/25 - typical embedment depth

Anchor size		Ø8	Ø10	Ø12	Ø14	Ø16	Ø20	Ø25
Embedment depth	$h_{ef} = h_{ef,typ}$ [mm]	80	90	110	125	145	170	210
Base material thickness	$h = h_{min}$ [mm]	110	120	140	161	185	220	274
Edge distance	$c = c_{min}$ [mm]	40	50	60	70	80	100	125
	Tensile N_{Rd}: single anchor, min. edge distance ($c = c_{min}$)							
	Non-cracked concrete							
	B500 B [kN]	6,4	9,0	13,2	17,5	23,1	30,5	42,1
	Cracked concrete							
B500 B [kN]	-	5,2	7,6	10,1	13,4	-	-	
	Shear V_{Rd}: single anchor, min. edge distance ($c = c_{min}$), without lever arm							
	Non-cracked concrete							
	B500 B [kN]	3,7	5,3	7,3	9,5	11,9	17,2	25,0
	Cracked concrete							
B500 B [kN]	-	3,8	5,2	6,7	8,4	-	-	

**Design resistance: concrete C 20/25 - typical embedment depth
(load values are valid for single anchor)**

Anchor size		Ø8	Ø10	Ø12	Ø14	Ø16	Ø20	Ø25
Embedment depth	$h_{ef} = h_{ef,typ}$ [mm]	80	90	110	125	145	170	210
Base material thickness	$h = h_{min}$ [mm]	110	120	140	161	185	220	274
Spacing	$s = s_{min}$ [mm]	40	50	60	70	80	100	125
	Tensile N_{Rd}: double anchor, no edge effects, min. spacing ($s = s_{min}$)							
	Non-cracked concrete							
	B500 B [kN]	7,4	10,1	14,7	19,1	25,0	35,1	48,3
	Cracked concrete							
B500 B [kN]	-	6,0	8,8	11,5	15,1	-	-	
	Shear V_{Rd}: double anchor, no edge effects, min. spacing ($s = s_{min}$), without lever arm							
	Non-cracked concrete							
	B500 B [kN]	9,3	14,7	20,7	28,0	36,7	57,3	90,0
	Cracked concrete							
B500 B [kN]	-	12,3	18,0	23,9	31,6	-	-	

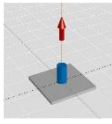
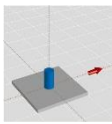

Design resistance: concrete C 20/25 - embedment depth = 12 d^{a)}

Anchor size	Ø8	Ø10	Ø12	Ø14	Ø16	Ø20	Ø25	
Embedment depth $h_{ef} = 12 d^{a)}$ [mm]	96	120	144	168	192	240	300	
Base material thickness $h = h_{min}$ [mm]	126	150	174	204	232	290	364	
	Tensile N_{Rd}: single anchor, no edge effects							
	Non-cracked concrete							
	B500 B [kN]	12,7	19,9	28,7	39,0	50,9	79,6	124,4
	Cracked concrete							
B500 B [kN]	-	11,5	16,6	22,6	29,5	-	-	
	Shear V_{Rd}: single anchor, no edge effects, without lever arm							
	Non-cracked concrete							
	B500 B [kN]	9,3	14,7	20,7	28,0	36,7	57,3	90,0
	Cracked concrete							
B500 B [kN]	-	14,7	20,7	28,0	36,7	-	-	

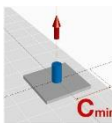
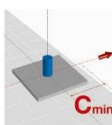
Design resistance: concrete C 20/25 - embedment depth = 12 d^{a)}

Anchor size	Ø8	Ø10	Ø12	Ø14	Ø16	Ø20	Ø25	
Embedment depth $h_{ef} = 12 d^{a)}$ [mm]	96	120	144	168	192	240	300	
Base material thickness $h = h_{min}$ [mm]	126	150	174	204	232	290	364	
Edge distance $c = c_{min}$ [mm]	40	50	60	70	80	100	125	
	Tensile N_{Rd}: single anchor, min. edge distance ($c = c_{min}$)							
	Non-cracked concrete							
	B500 B [kN]	7,7	12,0	17,2	23,5	30,6	46,7	65,2
	Cracked concrete							
B500 B [kN]	-	6,9	10,0	13,6	17,7	-	-	
	Shear V_{Rd}: single anchor, min. edge distance ($c = c_{min}$), without lever arm							
	Non-cracked concrete							
	B500 B [kN]	3,9	5,7	7,8	10,2	12,9	18,9	27,8
	Cracked concrete							
B500 B [kN]	-	4,0	5,5	7,2	9,1	-	-	

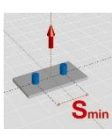
Design resistance: concrete C 20/25 - embedment depth = 12 d ^{a)}
(load values are valid for single anchor)

Anchor size	Ø8	Ø10	Ø12	Ø14	Ø16	Ø20	Ø25	
Embedment depth $h_{ef} = 12 d^{a)}$ [mm]	96	120	144	168	192	240	300	
Base material thickness $h = h_{min}$ [mm]	126	150	174	204	232	290	364	
Spacing $s = s_{min}$ [mm]	40	50	60	70	80	100	125	
	Tensile N_{Rd}: double anchor, no edge effects, min. spacing ($s = s_{min}$)							
	Non-cracked concrete							
	B500 B [kN]	8,9	13,8	19,6	26,4	34,1	52,1	79,4
	Cracked concrete							
B500 B [kN]	-	8,1	11,6	15,7	20,3	-	-	
	Shear V_{Rd}: double anchor, no edge effects, min. spacing ($s = s_{min}$), without lever arm							
	Non-cracked concrete							
	B500 B [kN]	9,3	14,7	20,7	28,0	36,7	57,3	90,0
	Cracked concrete							
B500 B [kN]	-	14,7	20,7	28,0	36,7	-	-	

a) d = element diameter

Hilti HIT-HY 70 mortar for masonry

Injection mortar system		Benefits
	Hilti HIT-HY 70 330 ml foil pack (also available as 500 ml and 1400 ml foil pack)	<ul style="list-style-type: none"> - chemical injection fastening for all type of base materials: - hollow and solid - clay bricks, sand-lime bricks, normal and light weight concrete blocks, aerated light weight concrete, natural stones - two-component hybrid mortar - rapid curing - versatile and convenient handling - flexible setting depth and fastening thickness - small edge distance and anchor spacing - mortar filling control with HIT-SC sleeves - suitable for overhead fastenings - in-service temperatures: short term: max.80°C long term: max 50°C
	Mixer	
	HIT-V rod	
	HAS, HAS-E rod	
	HIT-IC internal threaded sleeve	
	HIS-RN sleeve	
	HIT-SC composite sleeve	



Concrete

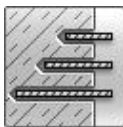

Variable embedment depth

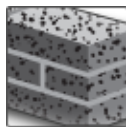

Solid brick

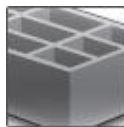

Hollow brick



Autoclaved aerated concrete



Fire resistance

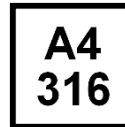

Corrosion resistance



High corrosion resistance



PROFIS Anchor design software

Approvals / certificates

Description	Authority / Laboratory	No. / date of issue
European Technical Approval	DIBt, Berlin	ETA-09/0265 / 2009-09-28
Allgemeine bauaufsichtliche Zulassung (national German approval)	DIBt, Berlin	Z-21.3-1830 / 2011-12-01
Fiche technique SOCOTEC ^{a)}	SOCOTEC, Paris	YX 0047 06.2012
Fire test report	MFPA, Leipzig	PB III/B-07-157 / 2012-03-03
Assessment report (fire)	warringtonfire	WF 327804/B / 2013-07-10

Basic loading data (for a single anchor)



All data in the table below applies to

- Load values valid for holes drilled with TE rotary hammers in hammering mode
- Correct anchor setting (see instruction for use, setting details)
- Steel quality of fastening elements: see data below
- Steel quality for screws for HIT-IG, HIT-IC and HIS-N: min. strength 5.8 / HIS-RN: A4-70
- Threaded rods of appropriate size (diameter and length) and a minimum steel quality of 5.6 can be used
- Base material temperature during installation and curing must be between -5°C through +40°C

(Exception: solid clay bricks (e.g. Mz12): +5°C till 40°C)

Recommended loads ^{a)} F_{rec} for brick breakout and pull out in [kN]

Solid masonry: HIT-HY 70 with HIT-V, HAS, HAS-E and HIT-IC

Anchor size			HIT-V, HAS, HAS-E				HIT-IC		
Base material	Setting depth [mm]		M6	M8	M10	M12	M8	M10	M12
Solid clay brick Mz12/2,0 DIN 105/ EN 771-1 $f_b^{b)} \geq 12 \text{ N/mm}^2$  Germany, Austria, Switzerland	80	N_{rec} [kN]	-	1,0	1,7	1,7	1,7	1,7	1,7
		V_{rec} [kN]	-	1,0	1,7	1,7	1,7	1,7	1,7
		N_{rec} [kN]	-	3,0 ^{c)}	3,0 ^{c)}	3,0 ^{c)}	3,0 ^{c)}	3,0 ^{c)}	3,0 ^{c)}
		V_{rec} [kN]	-	3,0 ^{c)}	3,0 ^{c)}	3,0 ^{c)}	3,0 ^{c)}	3,0 ^{c)}	3,0 ^{c)}
Solid sand-lime brick KS 12/2,0 DIN 106/ EN 771-2 $f_b^{b)} \geq 12 \text{ N/mm}^2$  Germany, Austria, Switzerland	80	N_{rec} [kN]	-	1,0	1,7	1,7	1,7	1,7	1,7
		V_{rec} [kN]	-	1,0	1,7	1,7	1,7	1,7	1,7
		N_{rec} [kN]	-	3,0 ^{d)}	3,0 ^{d)}	3,0 ^{d)}	3,0 ^{d)}	3,0 ^{d)}	3,0 ^{d)}
		V_{rec} [kN]	-	3,0 ^{d)}	3,0 ^{d)}	3,0 ^{d)}	3,0 ^{d)}	3,0 ^{d)}	3,0 ^{d)}

a) Recommended load values for German base materials are based on national regulations.

b) f_b = brick strength

c) Values only valid for Mz (DIN 105) with brick strength $\geq 29 \text{ N/mm}^2$, density $2,0 \text{ kg/dm}^3$, minimum brick size NF (24,0cm x 11,5cm x 7,1cm), not covered by national German approval Z-21.3-1830 / 2009-01-20

d) Values only valid for KS (DIN 106) with brick strength $\geq 23 \text{ N/mm}^2$, density $2,0 \text{ kg/dm}^3$, minimum brick size NF (24,0cm x 11,5cm x 7,1cm), not covered by national German approval Z-21.3-1830 / 2009-01-20

Recommended loads ^{a)} F_{rec} for brick breakout and pull out in [kN]
Solid masonry: HIT-HY 70 with HIT-V, HAS, HAS-E and HIT-IC

Anchor size			HIT-V, HAS, HAS-E				HIT-IC		
Base material	Setting depth [mm]		M6	M8	M10	M12	M8	M10	M12
Aerated concrete PPW 2-0,4 DIN 4165/ EN 771-4 $f_b^{b)} \geq 2 \text{ N/mm}^2$  Germany, Austria, Switzerland	80	N _{rec} [kN]	-	0,5	0,6	0,6	0,6	0,6	0,6
		V _{rec} [kN]	-	0,1	0,1	0,2	0,2	0,4	0,4
Lightweight concrete acc. TGL (haufwerks- poriger Leichtbeton), Germany	80	N _{rec} [kN]	-	1,0	1,0	1,5	1,5	1,5	1,5
		V _{rec} [kN]	-	1,0	1,0	1,5	1,5	1,5	1,5

a) Recommended load values for German base materials are based on national regulations.

b) f_b = brick strength

Basic loading data (for a single anchor)

All data in the table below applies to

- Load values valid for holes drilled with TE rotary hammers **in sensitive** hammering mode
- Correct anchor setting (see instruction for use, setting details)
- Steel quality of fastening elements: see data above;
- Steel quality for screws for HIT-IG: min. strength 5.8
- Threaded rods of appropriate size (diameter and length) and a minimum steel quality of 5.6 can be used

**Recommended loads ^{a)} F_{rec} for brick breakout and pull out in [kN]:
Hollow masonry: HIT-HY 70 with HIT-SC and HIT-V, HAS, HAS-E and HIT-IC**

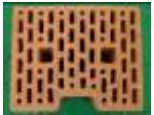
Anchor size			HIT-V, HAS, HAS-E				HIT-IC				
			M6	M8	M10	M12	M8	M10	M12		
Base material	Setting depth [mm]		HIT-SC 12x...	HIT-SC 16x...	HIT-SC 16x...	HIT-SC 18x...	HIT-SC 16x...	HIT-SC 18x...	HIT-SC 22x...	HIT-SC 22x...	
HizB 6 DIN 105/ EN 771-1 f _b ^{b)} ≥ 6 N/mm ²  Germany, Austria, Switzerland	50	N _{rec} [kN]	0,3	0,4	0,4	0,8	-	-	-	-	
		V _{rec} [kN]	0,3	0,4	0,4	0,4	-	-	-	-	
	80	N _{rec} [kN]	-	0,8	0,8	0,8	0,8	0,8	0,8	0,8	
		V _{rec} [kN]	-	0,8	0,8	0,8	0,8	0,8	0,8	0,8	
	100	N _{rec} [kN]	-	0,8	0,8	0,8	-	-	-	-	
		V _{rec} [kN]	-	0,8	0,8	0,8	-	-	-	-	
	130	N _{rec} [kN]	-	0,84	0,84	0,8	-	-	-	-	
		V _{rec} [kN]	-	0,8	0,8	0,8	-	-	-	-	
	160	N _{rec} [kN]	-	0,91	0,91	0,8	-	-	-	-	
		V _{rec} [kN]	-	0,8	0,8	0,8	-	-	-	-	
	Hiz 12 DIN 105/ EN 771-1 f _b ^{b)} ≥ 12 N/mm ²  Germany, Austria, Switzerland	50	N _{rec} [kN]	0,6	0,8	0,8	0,8	-	-	-	-
			V _{rec} [kN]	0,6	0,8	0,8	0,8	-	-	-	-
80		N _{rec} [kN]	-	1,0	1,0	1,0	1,0	1,0	1,0	1,0	
		V _{rec} [kN]	-	1,0	1,0	1,0	1,0	1,0	1,0	1,0	
100		N _{rec} [kN]	-	1,54	1,54	1,54	-	-	-	-	
		V _{rec} [kN]	-	1,4	1,4	1,4	-	-	-	-	
130		N _{rec} [kN]	-	1,68	1,68	1,54	-	-	-	-	
		V _{rec} [kN]	-	1,4	1,4	1,4	-	-	-	-	
160		N _{rec} [kN]	-	1,82	1,82	1,54	-	-	-	-	
		V _{rec} [kN]	-	1,4	1,4	1,4	-	-	-	-	

a) Recommended load values for German base materials are based on national regulations.

b) f_b = brick strength



Recommended loads ^{a)} F_{rec} for brick breakout and pull out in [kN]:
Hollow masonry: HIT-HY 70 with HIT-SC and HIT-V, HAS, HAS-E and HIT-IC

Anchor size			HIT-V, HAS, HAS-E				HIT-IC			
			M6	M8	M10	M12	M8	M10	M12	
Base material	Setting depth [mm]		HIT-SC 12x...	HIT-SC 16x...	HIT-SC 16x...	HIT-SC 18x...	HIT-SC 16x...	HIT-SC 18x...	HIT-SC 22x...	HIT-SC 22x...
			KSL 12 DIN 106/ EN 771-2 $f_b^{b)} \geq 12 \text{ N/mm}^2$  Germany, Austria, Switzerland	50	N_{rec} [kN]	0,5	0,7	0,7	0,7	-
V_{rec} [kN]	0,5	0,7			0,7	0,7	-	-	-	-
80	N_{rec} [kN]	-		1,4	1,4	1,4	1,4	1,4	1,0	1,0
	V_{rec} [kN]	-		1,4	1,4	1,4	1,4	1,4	1,0	1,0
100	N_{rec} [kN]	-		1,4	1,4	1,4	-	-	-	-
	V_{rec} [kN]	-		1,4	1,4	1,4	-	-	-	-
130	N_{rec} [kN]	-		1,44	1,44	1,4	-	-	-	-
	V_{rec} [kN]	-		1,4	1,4	1,4	-	-	-	-
160	N_{rec} [kN]	-		1,56	1,56	1,4	-	-	-	-
	V_{rec} [kN]	-		1,4	1,4	1,4	-	-	-	-

a) Recommended load values for German base materials are based on national regulations.

b) f_b = brick strength



**Recommended loads ^{a)} F_{rec} for brick breakout and pull out in [kN]:
Hollow masonry: HIT-HY 70 with HIT-SC and HIT-V, HAS, HAS-E and HIT-IC**

Anchor size			HIT-V, HAS, HAS-E				HIT-IC				
Anchor size			M6	M8	M10	M12	M8	M10	M12		
Base material	Setting depth [mm]		HIT-SC 12x...	HIT-SC 16x...	HIT-SC 16x...	HIT-SC 18x...	HIT-SC 16x...	HIT-SC 18x...	HIT-SC 22x...	HIT-SC 22x...	
Hbl 2 DIN 18 151/ EN 771-3 $f_b^{b)} \geq 2 \text{ N/mm}^2$  Germany, Austria, Switzerland	50	N _{rec} [kN]	0,3	0,5	0,5	0,5	-	-	-	-	
		V _{rec} [kN]	0,3	0,5	0,5	0,5	-	-	-	-	
	80	N _{rec} [kN]	-	0,5	0,5	0,5	0,5	0,5	0,5	0,5	
		V _{rec} [kN]	-	0,5	0,5	0,5	0,5	0,5	0,5	0,5	
	100	N _{rec} [kN]	-	0,7	0,7	0,7	-	-	-	-	
		V _{rec} [kN]	-	0,6	0,6	0,6	-	-	-	-	
	130	N _{rec} [kN]	-	0,72	0,72	0,7	-	-	-	-	
		V _{rec} [kN]	-	0,6	0,6	0,6	-	-	-	-	
	160	N _{rec} [kN]	-	0,78	0,78	0,7	-	-	-	-	
		V _{rec} [kN]	-	0,6	0,6	0,6	-	-	-	-	
	Hbl 4 DIN 18 151/ EN 771-3 $f_b^{b)} \geq 4 \text{ N/mm}^2$  Germany, Austria, Switzerland	50	N _{rec} [kN]	0,4	0,6	0,6	0,6	-	-	-	-
			V _{rec} [kN]	0,4	0,6	0,6	0,6	-	-	-	-
80		N _{rec} [kN]	-	0,8	0,8	0,8	0,8	0,8	0,8	0,8	
		V _{rec} [kN]	-	0,8	0,8	0,8	0,8	0,8	0,8	0,8	
Hbn 4 DIN 18 153/ EN 771-3 $f_b^{b)} \geq 4 \text{ N/mm}^2$  Germany, Austria, Switzerland	50	N _{rec} [kN]	0,4	0,6	0,6	0,6	-	-	-	-	
		V _{rec} [kN]	0,4	0,6	0,6	0,6	-	-	-	-	
	80	N _{rec} [kN]	-	0,8	0,8	0,8	0,8	0,8	0,8	0,8	
		V _{rec} [kN]	-	0,8	0,8	0,8	0,8	0,8	0,8	0,8	

a) Recommended load values for German base materials are based on national regulations.

b) f_b = brick strength

Recommended loads ^{a)} F_{rec} for brick breakout and pull out in [kN]:
Hollow masonry: HIT-HY 70 with HIT-SC and HIT-V, HAS, HAS-E and HIT-IC



Anchor size			HIT-V, HAS, HAS-E				HIT-IC				
			M6	M8	M10	M12	M8	M10	M12		
Base material	Setting depth [mm]		HIT-SC 12x...	HIT-SC 16x...	HIT-SC 16x...	HIT-SC 18x...	HIT-SC 16x...	HIT-SC 18x...	HIT-SC 22x...	HIT-SC 22x...	
Brique creuse C40 NF-P 13-301/ EN 771-1 $f_b^{b)} \geq 4 \text{ N/mm}^2$  France	80	N_{rec} [kN]	-	0,5	0,5	0,5	0,5	0,5	0,5	0,5	
		V_{rec} [kN]	-	1,0	1,0	1,0	1,0	1,0	1,0	1,0	
	100	N_{rec} [kN]	-	0,5	0,5	0,5	-	-	-	-	
		V_{rec} [kN]	-	1,0	1,0	1,0	-	-	-	-	
	130	N_{rec} [kN]	-	0,5	0,5	0,5	-	-	-	-	
		V_{rec} [kN]	-	1,0	1,0	1,0	-	-	-	-	
	160	N_{rec} [kN]	-	0,5	0,5	0,5	-	-	-	-	
		V_{rec} [kN]	-	1,0	1,0	1,0	-	-	-	-	
	Parpaing creux B40 NF-P 14-301/ EN 771-3 $f_b^{b)} \geq 4 \text{ N/mm}^2$  France	80	N_{rec} [kN]	-	0,7	0,7	0,7	0,7	0,7	0,7	0,7
			V_{rec} [kN]	-	1,5	1,5	1,5	1,5	1,5	1,5	1,5
		100	N_{rec} [kN]	-	0,7	0,7	0,7	-	-	-	-
			V_{rec} [kN]	-	1,5	1,5	1,5	-	-	-	-
130		N_{rec} [kN]	-	0,7	1,2	1,2	-	-	-	-	
		V_{rec} [kN]	-	1,5	1,7	1,7	-	-	-	-	
160		N_{rec} [kN]	-	0,7	1,2	1,2	-	-	-	-	
		V_{rec} [kN]	-	1,5	1,7	1,7	-	-	-	-	

a) Recommended load values for French base materials are based on national regulations.

b) f_b = brick strength

Recommended loads F_{rec} for brick breakout and pull out in [kN]: Hollow masonry: HIT-HY 70 with HIT-SC and HIT-V, HAS, HAS-E and HIT-IC

Values in brackets: mean ultimate loads $F_{u,m}$ [kN]:



Anchor size			HIT-V, HAS, HAS-E				HIT-IC			
Base material	Setting depth [mm]		M6	M8	M10	M12	M8	M10		M12
			HIT-SC 12x...	HIT-SC 16x...	HIT-SC 16x...	HIT-SC 18x...	HIT-SC 16x...	HIT-SC 18x...	HIT-SC 22x...	HIT-SC 22x...
Mattone Alveolater 50 EN 771-1 $f_b^{b)} \geq 16 \text{ N/mm}^2$  Italy	50	N_{rec} [kN]	0,9 (4,2)	1,1	1,1 (4,9)	1,25	-	-	-	-
		V_{rec} [kN]	1,2 (5,8)	1,2	1,2	1,2	-	-	-	-
	80	N_{rec} [kN]	1,1 (5,0)	1,5	1,5	1,7	1,5 (7,0)	1,7	1,7	1,7
		V_{rec} [kN]	1,2 (5,3)	1,2	1,2	1,2	1,2	1,2	2,0	2,0
	100	N_{rec} [kN]	-	1,5	1,5	1,7	-	-	-	-
		V_{rec} [kN]	-	1,2	1,2	1,2	-	-	-	-
	130	N_{rec} [kN]	-	2,3 (10,4)	2,3	2,8	-	-	-	-
		V_{rec} [kN]	-	1,2	1,2	1,2	-	-	-	-
	160	N_{rec} [kN]	-	2,3	2,3	2,8	-	-	-	-
		V_{rec} [kN]	-	1,2	1,2	1,2	-	-	-	-
Doppio uni EN 771-1 $f_b^{b)} \geq 27 \text{ N/mm}^2$  Italy	50	N_{rec} [kN]	0,65 (2,9)	0,65	0,65	0,65	-	-	-	-
		V_{rec} [kN]	1,3 (5,7)	1,3	1,3 (6,6)	1,3	-	-	-	-
	80	N_{rec} [kN]	1,0 (5,0)	1,0	1,0 (6,8)	1,0	1,0	1,0	1,0	1,0 (4,5)
		V_{rec} [kN]	1,3 (6,1)	1,9	1,9 (8,5)	1,9	1,9	1,9	2,0	2,0
	100	N_{rec} [kN]	-	1,0	1,0	1,0	-	-	-	-
		V_{rec} [kN]	-	1,9	1,9	1,9	-	-	-	-
	130	N_{rec} [kN]	-	2,0	2,0 (12,1)	2,0	-	-	-	-
		V_{rec} [kN]	-	1,9	1,9	1,9	-	-	-	-
	160	N_{rec} [kN]	-	2,0	2,0	2,0	-	-	-	-
		V_{rec} [kN]	-	1,9	1,9	1,9	-	-	-	-
Foratino 4 Fori EN 771-1 $f_b^{b)} \geq 7 \text{ N/mm}^2$  Italy	80	N_{rec} [kN]	0,6 (2,7)	0,7 (3,3)	0,7	1,0	0,7	1,0	1,0	1,0 (5,2)
		V_{rec} [kN]	0,9	0,9	0,9	0,9	0,9	0,9	1,0	1,0
	100	N_{rec} [kN]	-	0,7	0,7	1,0	-	-	-	-
		V_{rec} [kN]	-	0,9	0,9	0,9	-	-	-	-
	130	N_{rec} [kN]	-	1,5 (6,7)	1,5	1,9	-	-	-	-
		V_{rec} [kN]	-	0,9	0,9	0,9	-	-	-	-
	160	N_{rec} [kN]	-	1,5 (7,3)	1,5	1,5	-	-	-	-
		V_{rec} [kN]	-	0,9	0,9	1,0	-	-	-	-

a) Recommended load values with consideration of a global safety factor $\gamma_{global} = 3,0$: $F_{rec} = F_{RK} / \gamma_{global}$

b) f_b = brick strength

Recommended loads F_{rec} for brick breakout and pull out in [kN]: Hollow masonry: HIT-HY 70 with HIT-SC and HIT-V, HAS, HAS-E and HIT-IC

Values in brackets: mean ultimate loads $F_{u,m}$ [kN]:

Anchor size			HIT-V, HAS, HAS-E				HIT-IC			
Base material	Setting depth [mm]		M6	M8	M10	M12	M8	M10	M12	
			HIT-SC 12x...	HIT-SC 16x...	HIT-SC 16x...	HIT-SC 18x...	HIT-SC 16x...	HIT-SC 18x...	HIT-SC 22x...	HIT-SC 22x...
Mattone rosso EN 771-1 $f_b^{b)} \geq 26 \text{ N/mm}^2$  Italy	50	N_{rec} [kN]	0,35 (1,7)	0,45	0,45 (2,0)	0,45	-	-	-	-
		V_{rec} [kN]	-	-	-	-	-	-	-	-
	80	N_{rec} [kN]	0,5 (2,9)	0,5 (2,1)	0,5 (3,3)	0,6	0,5	0,6	0,6 (4,2)	0,6
		V_{rec} [kN]	-	-	-	-	-	-	-	-
Blocchi cem 2 Fori EN 771-3 $f_b^{b)} \geq 8 \text{ N/mm}^2$  Italy	50	N_{rec} [kN]	1,0 (5,8)	1,25 (6,6)	1,25	1,25				
		V_{rec} [kN]	1,5 (7,2)	1,5	1,5	1,5				
	80	N_{rec} [kN]	1,0 (4,6)	1,25 (6,8)	1,25	1,25	1,25	1,25	1,25 (5,6)	1,25
		V_{rec} [kN]	1,5 (7,1)	2,0	2,0	2,0	2,0	2,0	2,0	2,0

a) Recommended load values with consideration of a global safety factor $\gamma_{global} = 3,0$: $F_{rec} = F_{Rk} / \gamma_{global}$

b) f_b = brick strength

Recommended loads F_{rec} for brick breakout and pull out in [kN]

Solid masonry: HIT-HY 70 with HIT-V, HAS, HAS-E and HIT-IC

Anchor size			HIT-V, HAS, HAS-E or Rebar ^{c)}				
Base material	Setting depth [mm]		Rod M8 or Rebar $\varnothing 8^d$	Rod M10 or Rebar $\varnothing 10^d$	Rod M12 or Rebar $\varnothing 12^d$	Rod M14 or Rebar $\varnothing 14^d$	Rod M16 or Rebar $\varnothing 16^d$
			Volcanic rock (Tufo) EN 771-3 $f_b^{b)} \geq 4,3 \text{ N/mm}^2$  Italy	80	N_{rec} [kN]	0,9	-
V_{rec} [kN]	0,9	-			-	-	-
100	N_{rec} [kN]	-		1,2	-	-	-
	V_{rec} [kN]	-		1,2	-	-	-
120	N_{rec} [kN]	-		-	1,5	-	-
	V_{rec} [kN]	-		-	1,5	-	-
140	N_{rec} [kN]	-		-	-	1,8	-
	V_{rec} [kN]	-		-	-	1,8	-
160	N_{rec} [kN]	-		-	-	-	2,1
	V_{rec} [kN]	-		-	-	-	2,1

a) Recommended load values with consideration of a global safety factor $\gamma_{global} = 3,0$: $F_{rec} = F_{Rk} / \gamma_{global}$





b) f_b = brick strength

c) Minimum base material thickness h = setting depth + 50mm.

d) Drill bit diameters for rebars BSt 500S:

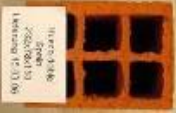
$\varnothing 8$: $d_0=12\text{mm}$; $\varnothing 10$: $d_0=14\text{mm}$; $\varnothing 12$: $d_0=16\text{mm}$; $\varnothing 14$: $d_0=18\text{mm}$; $\varnothing 16$: $d_0=20\text{mm}$;



Recommended loads F_{rec} for brick breakout and pull out in [kN]: Hollow masonry: HIT-HY 70 with HIT-SC and HIT-V, HAS, HAS-E and HIT-IC
Values in brackets: mean ultimate loads $F_{u,m}$ [kN]:

Anchor size			HIT-V, HAS, HAS-E				HIT-IC			
Base material	Setting depth [mm]		M6	M8	M10	M12	M8	M10		M12
			HIT-SC 12x...	HIT-SC 16x...	HIT-SC 16x...	HIT-SC 18x...	HIT-SC 16x...	HIT-SC 18x...	HIT-SC 22x...	HIT-SC 22x...
Hueco doble EN 771-1 $f_b^{b)} \geq 4 \text{ N/mm}^2$  Spain	50	N_{rec} [kN]	0,5 (2,6)	0,5 (2,0)	0,5 (2,4)	0,5	-	-	-	-
		V_{rec} [kN]	0,9 (4,2)	0,9	0,9	0,9	-	-	-	-
	80	N_{rec} [kN]	0,7 (3,1)	0,9 (3,8)	0,9 (4,0)	1,1	0,9 (4,0)	1,1	1,1 (6,3)	1,1
		V_{rec} [kN]	1,0 (4,8)	1,0 (4,5)	1,0	1,0	1,0	1,0	1,7	1,7
Termoarcilla EN 771-1 $f_b^{b)} \geq 22 \text{ N/mm}^2$  Spain	50	N_{rec} [kN]	0,5 (3,1)	0,7	0,7	0,7	-	-	-	-
		V_{rec} [kN]	1,2 (5,5)	1,2	1,2	1,2	-	-	-	-
	80	N_{rec} [kN]	0,5 (2,4)	1,1 (5,2)	1,1	1,3	1,1	1,3	1,3 (5,8)	1,3
		V_{rec} [kN]	1,2 (5,6)	1,2	1,2	1,2	1,2	1,2	2,0	2,0
Ladrillo cara vista EN 771-1 $f_b^{b)} \geq 42 \text{ N/mm}^2$  Spain	50	N_{rec} [kN]	0,8 (4,5)	0,8 (3,6)	0,8	0,8				
		V_{rec} [kN]	1,5 (6,9)	1,6 (8,6)	1,6	1,6				
	80	N_{rec} [kN]	0,8	1,9	1,9	2,3	1,9 (8,5)	2,3	2,3	2,3 (10,4)
		V_{rec} [kN]	1,5	2,0 (12,4)	2,0	2,0	2,0	2,0	2,0	2,0
Clinker mediterraneo EN 771-1 $f_b^{b)} \geq 78 \text{ N/mm}^2$  Spain	50	N_{rec} [kN]	0,7 (3,3)	0,7 (3,1)	0,7	0,7	-	-	-	-
		V_{rec} [kN]	1,5 (6,4)	1,6 (7,8)	1,6	1,6	-	-	-	-
	80	N_{rec} [kN]	0,7	1,8 (8,0)	1,8	2,1	1,8 (8,3)	2,1	2,1	2,1 (9,7)
		V_{rec} [kN]	1,4 (6,4)	2,0 (9,5)	2,0	2,0	2,0 (14,4)	2,0	2,0	2,0

a) Recommended load values with consideration of a global safety factor $\gamma_{global} = 3,0$: $F_{rec} = F_{RK} / \gamma_{global}$





b) f_b = brick strength

Recommended loads F_{rec} for brick breakout and pull out in [kN]:
Hollow masonry: HIT-HY 70 with HIT-SC and HIT-V, HAS, HAS-E and HIT-IC

Anchor size			HIT-V, HAS, HAS-E				HIT-IC			
Anchor size			M6	M8	M10	M12	M8	M10		M12
Base material	Setting depth [mm]		HIT-SC 12x...	HIT-SC 16x...	HIT-SC 16x...	HIT-SC 18x...	HIT-SC 16x...	HIT-SC 18x...	HIT-SC 22x...	HIT-SC 22x...
Concrete Block EN 771-3 $f_b^{b)} \geq 7,0 \text{ N/mm}^2$ L x H x B [mm] 440 x 215 x 215  (Shell thickness 48 mm) Great Britain	50	N_{rec} [kN]	0,3	0,8	1,1	2,0	-	-	-	-
		V_{rec} [kN]	1,0	1,6	2,0	2,0	-	-	-	-
	80	N_{rec} [kN]	0,3	0,8	1,1	2,0	-	-	-	-
		V_{rec} [kN]	1,0	1,6	2,0	2,0	-	-	-	-
Concrete Block EN 771-3 $f_b^{b)} \geq 7 \text{ N/mm}^2$ L x H x B [mm] 440 x 215 x 138  (Shell thickness 48 mm) Great Britain	50	N_{rec} [kN]	0,4	0,6	0,7	1,5	-	-	-	-
		V_{rec} [kN]	0,9	1,7	1,7	1,7	-	-	-	-
	80	N_{rec} [kN]	0,4	0,6	0,7	1,5	-	-	-	-
		V_{rec} [kN]	0,9	1,7	1,7	1,7	-	-	-	-
Concrete Block EN 771-3 $f_b^{b)} \geq 7 \text{ N/mm}^2$ L x H x B [mm] 440 x 215 x 112  (Shell thickness 48 mm) Great Britain	50	N_{rec} [kN]	0,5	0,8	0,9	0,9	-	-	-	-
		V_{rec} [kN]	1,1	1,3	1,3	1,3	-	-	-	-

- a) Recommended load values with consideration of a global safety factor $\gamma_{global} = 3,0$: $F_{rec} = F_{RK} / \gamma_{global}$
 b) f_b = brick strength

Recommended loads F_{rec} for brick breakout and pull out in [kN]: Hollow masonry: HIT-HY 70 with HIT-SC and HIT-V, HAS, HAS-E and HIT-IC

Anchor size			HIT-V, HAS, HAS-E				HIT-IC			
Anchor size			M6	M8	M10	M12	M8	M10	M12	
Base material	Setting depth [mm]		HIT-SC 12x...	HIT-SC 16x...	HIT-SC 16x...	HIT-SC 18x...	HIT-SC 16x...	HIT-SC 18x...	HIT-SC 22x...	HIT-SC 22x...
Dense Concrete EN 771-3 $f_b^{b)} \geq 14 \text{ N/mm}^2$ L x H x B [mm] 440 x 215 x 100  Great Britain	50	N_{rec} [kN]	1,5	2,5	2,5	2,5	-	-	-	-
		V_{rec} [kN]	1,3	2,5	2,5	2,5	-	-	-	-
Dense Concrete EN 771-3 $f_b^{b)} \geq 14 \text{ N/mm}^2$ L x H x B [mm] 440 x 215 x 140  Great Britain	50	N_{rec} [kN]	1,5	2,5	2,5	2,5				
		V_{rec} [kN]	1,3	2,5	2,5	2,5				
	80	N_{rec} [kN]	1,5	3,0	3,0	3,0	3,0	3,0	3,0	4,0
		V_{rec} [kN]	1,3	2,5	2,5	2,5	2,5	2,5	3,0	3,0
Thermalite/Celcon EN 771-3 $f_b^{b)} \geq 6 \text{ N/mm}^2$ L x H x B [mm] 440 x 100 x 215  Great Britain	50	N_{rec} [kN]	0,7	0,8	0,8	0,8	-	-	-	-
		V_{rec} [kN]	0,5	0,6	0,6	0,6	-	-	-	-
	80	N_{rec} [kN]	1,3	1,5	1,5	1,7	1,5	1,7	1,7	1,7
		V_{rec} [kN]	0,9	1,0	1,0	1,0	1,0	1,0	1,2	1,2
Nostell Red Multi EN 771-3 $f_b^{b)} \geq 70 \text{ N/mm}^2$ L x H x B [mm] 215 x 102 x 65  Great Britain	50	N_{rec} [kN]	1,0	2,0	2,0	2,0				
		V_{rec} [kN]	1,5	3,0	3,0	3,0				
	80	N_{rec} [kN]	1,0	3,0	3,0	3,0	3,0	3,5	3,5	3,5
		V_{rec} [kN]	1,5	3,0	3,0	3,0	3,0	3,0	3,0	3,0

a) Recommended load values with consideration of a global safety factor $\gamma_{global} = 3,0$: $F_{rec} = F_{Rk} / \gamma_{global}$



b) f_b = brick strength

Recommended loads F_{rec} for brick breakout and pull out in [kN]:
Hollow masonry: HIT-HY 70 with HIT-SC and HIT-V, HAS, HAS-E and HIT-IC

Anchor size			HIT-V, HAS, HAS-E				HIT-IC			
Anchor size			M6	M8	M10	M12	M8	M10	M12	
Base material	Setting depth [mm]		HIT-SC 12x...	HIT-SC 16x...	HIT-SC 16x...	HIT-SC 18x...	HIT-SC 16x...	HIT-SC 18x...	HIT-SC 22x...	HIT-SC 22x...
London yellow Multi Stock EN 771-3 $f_b^{b)} \geq 16 \text{ N/mm}^2$ L x H x B [mm] 215 x 100 x 65  Great Britain	50	N_{rec} [kN]	1,0	1,3	1,3	1,7	-	-	-	-
		V_{rec} [kN]	1,4	1,9	1,9	1,9	-	-	-	-
	80	N_{rec} [kN]	2,0	3,0	3,0	3,0	3,0	3,0	3,0	4,0
		V_{rec} [kN]	1,4	2,5	2,5	2,5	2,5	2,5	3,0	3,0

- a) Recommended load values with consideration of a global safety factor $\gamma_{global} = 3,0$: $F_{rec} = F_{Rk} / \gamma_{global}$
 b) f_b = brick strength

Recommended loads F_{rec} for brick breakout and/or pull out in [kN]:
Hollow masonry: HIT-HY 70 with HIT-SC and HIT-V, HAS, HAS-E and HIT-IC

Anchor size			HIT-V, HAS, HAS-E				HIT-IC		
Base material	Setting depth [mm]	Base material	M6	M8	M10	M12	M8	M10	M12
Dense Concrete EN 771-3 $f_b^{b)} \geq 14 \text{ N/mm}^2$ L x H x B [mm] 440 x 215 x 100  Great Britain	80	N_{rec} [kN]	-	2,5	2,5	2,5	-	-	-
		V_{rec} [kN]	-	2,5	2,5	3,0	-	-	-
Dense Concrete EN 771-3 $f_b^{b)} \geq 14 \text{ N/mm}^2$ L x H x B [mm] 440 x 215 x 140  Great Britain	80	N_{rec} [kN]	-	3,5 ^{c)}	4,0 ^{c)}	4,5 ^{c)}	-	-	-
		V_{rec} [kN]	-	2,5	2,5	3,0	-	-	-

- a) Recommended load values with consideration of a global safety factor $\gamma_{global} = 3,0$: $F_{rec} = F_{Rk} / \gamma_{global}$
 b) f_b brick strength
 c) The minimum value of brick break out and/or pull out given in the table and of pull out of one brick is decisive.

Recommended loads F_{rec} for brick breakout and pull out in [kN]:
Hollow masonry: HIT-HY 70 with HIT-SC and HIT-V, HAS, HAS-E and HIT-IC

Anchor size			HIT-V, HAS, HAS-E				HIT-IC			
Anchor size			M6	M8	M10	M12	M8	M10	M12	
Base material	Setting depth [mm]		HIT-SC 12x...	HIT-SC 16x...	HIT-SC 16x...	HIT-SC 18x...	HIT-SC 16x...	HIT-SC 18x...	HIT-SC 22x...	HIT-SC 22x...
Fire light brick Scoria Blend $f_b^{b)} \geq 16 \text{ N/mm}^2$ L x H x B [mm] 230 x 110 x 119  (Shell thickness 19 mm) Australia	50	N_{rec} [kN]	0,5	0,5	0,5	0,8	-	-	-	-
		V_{rec} [kN]	1,0	1,5	1,5	1,5	-	-	-	-
	80	N_{rec} [kN]	1,8	1,8	1,8	1,8	1,8	1,8	1,8	1,8
		V_{rec} [kN]	1,25	2,0	2,0	2,0	2,0	2,0	2,0	2,0
Hollow Block $f_b^{b)} \geq 15 \text{ N/mm}^2$ L x H x B [mm] 390 x 190 x 190  (Shell thickness 30 mm) Australia	50	N_{rec} [kN]	0,6	0,6	0,6	0,6	-	-	-	-
		V_{rec} [kN]	1,0	1,5	1,5	1,5	-	-	-	-
	80	N_{rec} [kN]	0,6	0,9	0,9	1,7	0,9	1,7	1,7	1,7
		V_{rec} [kN]	1,25	2,0	2,0	2,0	2,0	2,0	2,0	2,0
Clay common (Standard) $f_b^{b)} \geq 84 \text{ N/mm}^2$ L x H x B [mm] 230 x 110 x 76  (Shell thickness 20 mm) Australia	50	N_{rec} [kN]	1,5	1,5	1,5	1,5	-	-	-	-
		V_{rec} [kN]	2,0	2,0	2,0	2,0	-	-	-	-
	80	N_{rec} [kN]	2,0	3,0	3,0	3,0	3,0	4,0	4,0	4,0
		V_{rec} [kN]	2,0	2,0	2,0	2,0	2,0	2,0	2,0	2,0

a) Recommended load values with consideration of a global safety factor $\gamma_{global} = 3,0$: $F_{rec} = F_{Rk} / \gamma_{global}$

b) f_b = brick strength

Recommended loads ^{a)} F_{rec} for brick breakout and pull out in [kN]
Solid masonry: HIT-HY 70 with HIT-V, HAS, HAS-E and HIT-IC

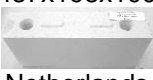
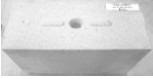
Anchor size			HIT-V, HAS, HAS-E				HIT-IC		
Base material	Setting depth [mm]		M6	M8	M10	M12	M8	M10	M12
Clay common (Dry pressed) $f_b^{b)} \geq 25 \text{ N/mm}^2$ L x H x B [mm] 230 x 110 x 76  Australia	80	N_{rec} [kN]	-	2,5	3,0	4,0	2,5	3,0	4,0
		V_{rec} [kN]	-	2,0	2,0	2,0	2,0	2,0	2,0
Calduran Solid sand-lime brick $f_b^{b)} \geq 22 \text{ N/mm}^2$ L x H x B [mm] 437x198x100  Netherlands	80	N_{rec} [kN]	-	-	2,5 ^{c)}	3,0 ^{c)}	3,0 ^{c)}	3,0 ^{c)}	4,0 ^{c)}
		V_{rec} [kN]	-	-	3,0	4,0	3,0	3,0	4,0
Calduran Solid sand-lime brick $f_b^{b)} \geq 22 \text{ N/mm}^2$ L x H x B [mm] 437x298x215  Netherlands	80	N_{rec} [kN]	-	-	2,5 ^{c)}	3,0 ^{c)}	3,0 ^{c)}	3,0 ^{c)}	4,0 ^{c)}
		V_{rec} [kN]	-	-	3,0	4,0	3,0	3,0	4,0

a) Recommended load values with consideration of a global safety factor $\gamma_{global} = 3,0$: $F_{rec} = F_{Rk} / \gamma_{global}$

b) f_b = brick strength



c) The minimum value of brick break out and/or pull out given in the table and of pull out of one brick is decisive.

Recommended loads F_{rec} for brick breakout and pull out in [kN]:
Hollow masonry: HIT-HY 70 with HIT-SC and HIT-V, HAS, HAS-E and HIT-IC

Anchor size			HIT-V, HAS, HAS-E				HIT-IC			
			M6	M8	M10	M12	M8	M10	M12	
Base material	Setting depth [mm]		HIT-SC 12x...	HIT-SC 16x...	HIT-SC 16x...	HIT-SC 18x...	HIT-SC 16x...	HIT-SC 18x...	HIT-SC 22x...	HIT-SC 22x...
Wienerberger Powerbrick $f_b^{b)} \geq 41 \text{ N/mm}^2$ L x H x B [mm] 285x135x135  Belgium	50	N_{rec} [kN]	1,0	1,25	1,25	1,25	-	-	-	-
		V_{rec} [kN]	1,5	2,0	2,0	2,0	-	-	-	-
	80	N_{rec} [kN]	1,5	1,75	1,75	2,0	1,75	2,0	2,0	2,0
		V_{rec} [kN]	1,5	3,0	3,0	3,0	3,0	3,0	4,0	4,0
Wienerberger Thermobrick $f_b^{b)} \geq 21 \text{ N/mm}^2$ L x H x B [mm] 285x135x138  Belgium	50	N_{rec} [kN]	0,5	0,75	0,75	1,0	-	-	-	-
		V_{rec} [kN]	1,0	1,25	1,25	1,25	-	-	-	-
	80	N_{rec} [kN]	1,5	1,75	1,75	1,75	1,75	1,75	1,75	1,75
		V_{rec} [kN]	1,5	2,0	2,0	2,0	2,0	2,0	2,5	2,5
Concrete hollow brick $f_b^{b)} \geq 6 \text{ N/mm}^2$ L x H x B [mm] 600x500x92  (Shell thickness 15 mm) Finland	50	N_{rec} [kN]	0,5	0,5	0,5	0,5	0,5	0,5	0,5	0,5
		V_{rec} [kN]	0,5	0,75	0,75	0,75	0,75	0,75	1,0	1,0
Leca typ 3 EN 771-3 $f_b \geq 3,0 \text{ N/mm}^2$  Sweden	80	N_{rec} [kN]	-	2,0	2,0	2,0	2,0	2,0	2,0	2,0
		V_{rec} [kN]	-	1,2	1,2	1,2	1,2	1,2	2,0	2,0

- a) Recommended load values with consideration of a global safety factor $\gamma_{global} = 3,0$: $F_{rec} = F_{Rk} / \gamma_{global}$
 b) f_b = brick strength

Recommended loads F_{rec} for brick breakout and pull out in [kN]:
Hollow masonry: HIT-HY 70 with HIT-SC and HIT-V, HAS, HAS-E and HIT-IC
Values in brackets: mean ultimate loads $F_{u,m}$ [kN]:

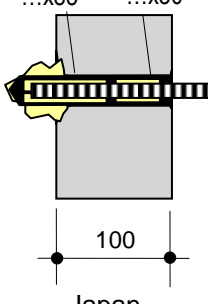
Anchor size			HIT-V, HAS, HAS-E				HIT-IC			
Base material	Setting depth [mm]		M6	M8	M10	M12	M8	M10		M12
			HIT-SC 12x...	HIT-SC 16x...	HIT-SC 16x...	HIT-SC 18x...	HIT-SC 16x...	HIT-SC 18x...	HIT-SC 22x...	HIT-SC 22x...
Concrete block $f_b^{b)} \geq 23 \text{ N/mm}^2$ L x H x B [mm] 390 x 190 x 120  (Shell thickness 25 mm) Japan	50	N_{rec} [kN]	1,25 (8,1)	1,5 (11,4)	1,5	2,0	-	-	-	-
		V_{rec} [kN]	1,25 (6,7)	1,5 (11,4)	1,5	1,5	-	-	-	-
	80	N_{rec} [kN]	1,25 (9,0)	1,5 (10,3)	1,5	2,0	1,5 (9,2)	2,0	2,0	2,0 (12,1)
		V_{rec} [kN]	1,25 (7,1)	1,5	1,5	1,5	1,5 (11,4)	1,5	2,0	2,0 (15,9)
Spancrete (Hollow Core Slab) $f_b^{b)} \geq 83 \text{ N/mm}^2$ L x H x B [mm] 1000 x 1000 x 125  (Shell thickness 27,5 mm) Japan	50	N_{rec} [kN]	1,25 (8,5)	2,0 (15,0)	2,0	2,5	2,5 (13,9)	2,5	2,5 (19,3)	-
		V_{rec} [kN]	1,25 (7,0)	2,5 (12,0)	2,5	2,5	2,5 (21,3)	2,5	3,0 (28,1)	-
Aerated concrete block $f_b^{b)} \geq 6 \text{ N/mm}^2$ L x H x B [mm] 1900 x 600 x 100 Special application: through fastening HIT-SC HIT-SC ...x85 ...x50  Japan	130	N_{rec} [kN]	1,25 (8,1)	1,75 (8,6)	1,75	2,0	-	-	-	-
		V_{rec} [kN]	0,75 (6,3)	1,00 (9,2)	1,00	1,00	-	-	-	-

- a) Recommended load values with consideration of a global safety factor $\gamma_{global} = 3,0$: $F_{rec} = F_{Rk} / \gamma_{global}$
 b) f_b = brick strength

Recommended loads ^{a)} F_{rec} for brick breakout and pull out in [kN]
Solid masonry: HIT-HY 70 with HIT-V, HAS, HAS-E and HIT-IC
Values in brackets: mean ultimate loads $F_{u,m}$ [kN]:

Anchor size			HIT-V, HAS, HAS-E				HIT-IC		
Base material	Setting depth [mm]		M6	M8	M10	M12	M8	M10	M12
Aerated concrete block $f_b^{b)} \geq 6 \text{ N/mm}^2$ L x H x B [mm] 1900 x 600 x 100  Japan	50	N_{rec} [kN]	-	-	-	0,75	-	-	0,75 (4,0)
		V_{rec} [kN]	-	-	-	1,0	-	-	1,0 (8,6)
	80	N_{rec} [kN]	-	-	1,5 (7,3)	1,75	-	1,75 (7,4)	1,75 (8,0)
		V_{rec} [kN]	-	-	0,75 (4,2)	1,0 (4,7)	-	1,0 (4,6)	1,0 (5,8)

a) Recommended load values with consideration of a global safety factor $\gamma_{global} = 3,0$: $F_{rec} = F_{Rk} / \gamma_{global}$

b) f_b brick strength

Design

Influence of joints:

If the joints of the masonry are not visible the recommended load N_{rec} has to be reduced with the factor $\alpha_j = 0.75$.

If the joints of the masonry are visible (e.g. unplastered wall) following has to be taken into account:

- The recommended load N_{rec} may be used only, if the wall is designed such that the joints are to be filled with mortar.
- If the wall is designed such that the joints are not to be filled with mortar then the recommended load N_{rec} may be used only, if the minimum edge distance c_{min} to the vertical joints is observed. If this minimum edge distance c_{min} can not be observed then the recommended load N_{rec} has to be reduced with the factor $\alpha_j = 0.75$.

The decisive resistance to tension loads is the lower value of N_{rec} (brick breakout, pull out) and $N_{max,pb}$ (pull out of one brick).

Pull out of one brick:

The allowable load of an anchor or a group of anchors in case of pull out of one brick, $N_{max,pb}$ [kN], is given in the following tables:

Clay bricks:

$N_{max,pb}$ [kN]		brick breadth b_{brick} [mm]					
		80	120	200	240	300	360
brick length l_{brick} [mm]	240	1,1	1,6	2,7	3,3	4,1	4,9
	300	1,4	2,1	3,4	4,1	5,1	6,2
	500	2,3	3,4	5,7	6,9	8,6	10,3

All other brick types:

$N_{max,pb}$ [kN]		brick breadth b_{brick} [mm]					
		80	120	200	240	300	360
brick length l_{brick} [mm]	240	0,8	1,2	2,1	2,5	3,1	3,7
	300	1,0	1,5	2,6	3,1	3,9	4,6
	500	1,7	2,6	4,3	5,1	6,4	7,7

$N_{max,pb}$ = resistance for pull out of one brick

l_{brick} = length of the brick

b_{brick} = breadth of the brick

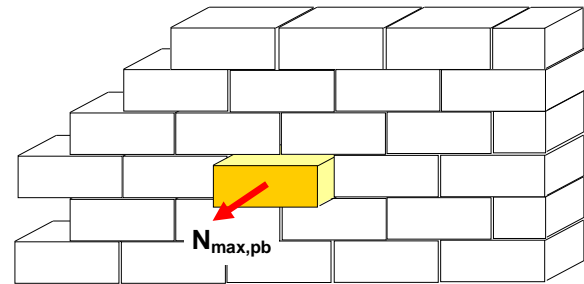
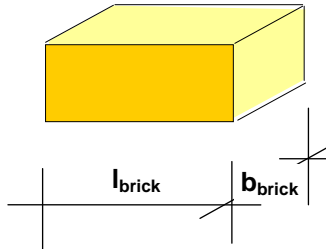

For all applications outside of the above mentioned base materials and / or setting conditions site tests have to be made for the determination of load values.
Due to the wide variety of natural stones site tests have to be made for determine of load values.

Materials

Material quality HAS / HIT-V

Part	Material
Threaded rod HAS-(E) / HIT-V	Strength class 5.8, $A_5 > 8\%$ ductile steel galvanized $\geq 5 \mu\text{m}$
Threaded rod HAS-(E)R / HIT-V	Stainless steel grade A4, $A_5 > 8\%$ ductile strength class 70, 1.4401; 1.4404; 1.4578; 1.4571; 1.4439; 1.4362
Washer ISO 7089	Steel galvanized, Stainless steel, 1.4401; 1.4404; 1.4578; 1.4571; 1.4439; 1.4362
Nut EN ISO 4032	Strength class 8, steel galvanized $\geq 5 \mu\text{m}$
	Strength class 70, stainless steel grade A4, 1.4401; 1.4404; 1.4578; 1.4571; 1.4439; 1.4362
	Strength class 70, high corrosion resistant steel, 1.4529; 1.4565

Material quality sleeves

Part	Material
HIT-IC sleeve	Carbon steel; galvanized to min. $5 \mu\text{m}$
HIT-SC sleeve	PA/PP

Setting

Installation equipment

Anchor size	M6	M8	M10	M12
Rotary hammer	TE2 – TE16			
Other tools	blow out pump, set of cleaning brushes, dispenser			

Setting instruction in solid base materials

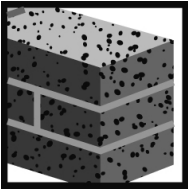

15	°F	°C	t _{gel}
	23	-5	10 min
	32	0	10 min
	41	5	10 min
	50	10	7 min
	68	20	4 min
	86	30	2 min
	104	40	1 min

16	°F	°C	t _{cure}
	23	-5	6 h
	32	0	4 h
	41	5	2.5 h
	50	10	1.5 h
	68	20	45 min
	86	30	30 min
	104	40	20 min

Base material temperature at time of installation:
Exception in solid clay brick:

Between -5°C and 40°C / 23°F and 104°F
Between +5°C and 40°C / 41°F and 104°F

Setting details: hole depth h_0 and effective anchorage depth in solid base materials

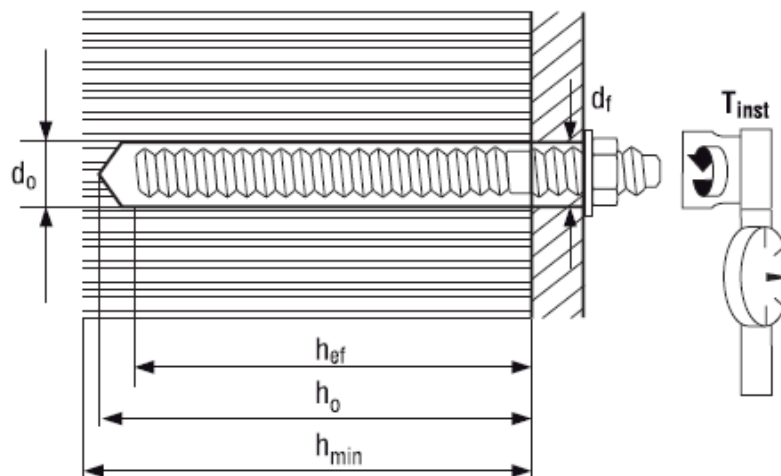
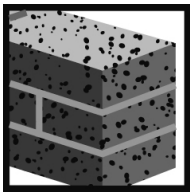

Setting details HIT-AC, HIT-V, HIT-V, HAS, HAS-E, HAS-R

Anchor size			HIT-V			HIT-V, HAS, HAS-E, HAS-R			
			M8	M10	M12	M8	M10	M12	M16
Nominal diameter of drill bit	d_0	[mm]	10	12	14	10	12	14	18
Effective anchorage depth	h_{ef}	[mm]	80	80	80	80	90	110	125
Hole depth	h_0	[mm]	85	85	85	85	95	115	130
Minimum base material thickness	h_{min}	[mm]	115	115	115	110	120	140	170
Diameter of clearance hole in the fixture	d_f	[mm]	9	12	14	9	12	14	18
Minimum spacing ^{a)}	s_{min}	[mm]	100	100	100	100	100	100	100
Minimum edge distance ^{a)}	c_{min}	[mm]	100	100	100	100	100	100	100
Torque moment	T_{inst}	[Nm]	5	8	10	5	8	10	10
Filling volume		[ml]	4	5	7	4	6	10	15

a) In case of **shear loads towards a free edge**: $c_{min} = 200$ mm

A distance from the edge of a broken brick of $c_{min} = 200$ mm is recommended, e.g. around window or door frames.

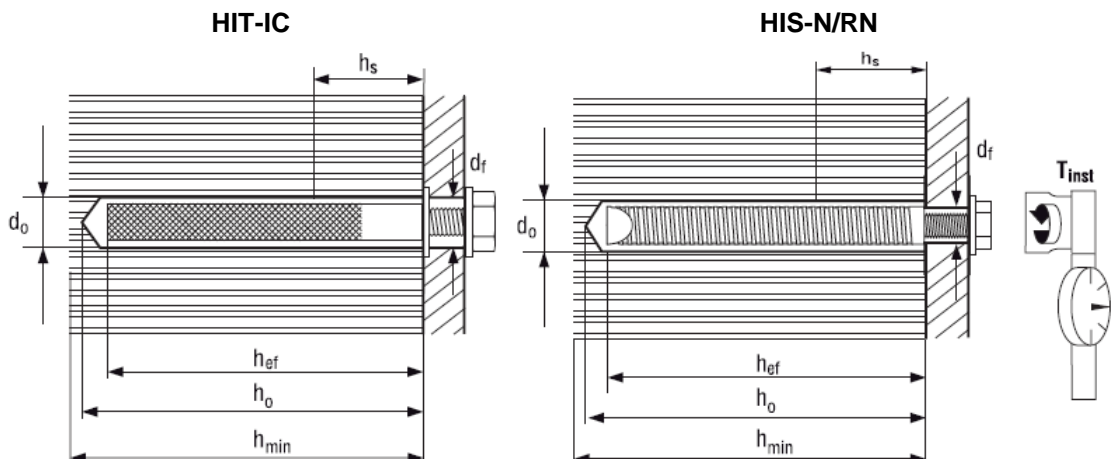
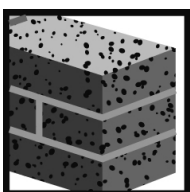

Setting details HIT-IC

Anchor size			HIT-IC			HIS-N/RN		
			M8	M10	M12	M8	M10	M12
Nominal diameter of drill bit	d_0	[mm]	14	16	18	14	18	22
Effective anchorage depth	h_{ef}	[mm]	80	80	80	90	110	125
Hole depth	h_0	[mm]	85	85	85	95	115	130
Minimum base material thickness	h_{min}	[mm]	115	115	115	120	150	170
Diameter of clearance hole in the fixture	d_f	[mm]	9	12	14	9	12	14
Length of bolt engagement	h_s	[mm]	min. 10 – max. 75			min. 8 max.20	min. 10 max.25	min 12 max.30
Minimum spacing ^{a)}	s_{min}	[mm]	100	100	100	100	100	100
Minimum edge distance ^{a)}	c_{min}	[mm]	100	100	100	100	100	100
Torque moment	T_{inst}	[Nm]	5	8	10	5	8	10
Filling volume		[ml]	6	6	6	6	10	16

a) In case of **shear loads towards a free edge**: $c_{min} = 20 \text{ cm}$

A distance from the edge of a broken brick of $c_{min} = 20 \text{ cm}$ is recommended, e.g. around window or door frames.

Setting instruction in hollow base material – using 330 ml foil pack

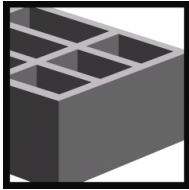

15	°F	°C	t _{gel}
	23	-5	10 min
	32	0	10 min
	41	5	10 min
	50	10	7 min
	68	20	4 min
	86	30	2 min
	104	40	1 min

16	°F	°C	t _{cure}
	23	-5	6 h
	32	0	4 h
	41	5	2.5 h
	50	10	1.5 h
	68	20	45 min
	86	30	30 min
	104	40	20 min

Setting details: hole depth h_0 and effective anchorage depth in hollow base materials HAS / HIT-V with HIT-SC

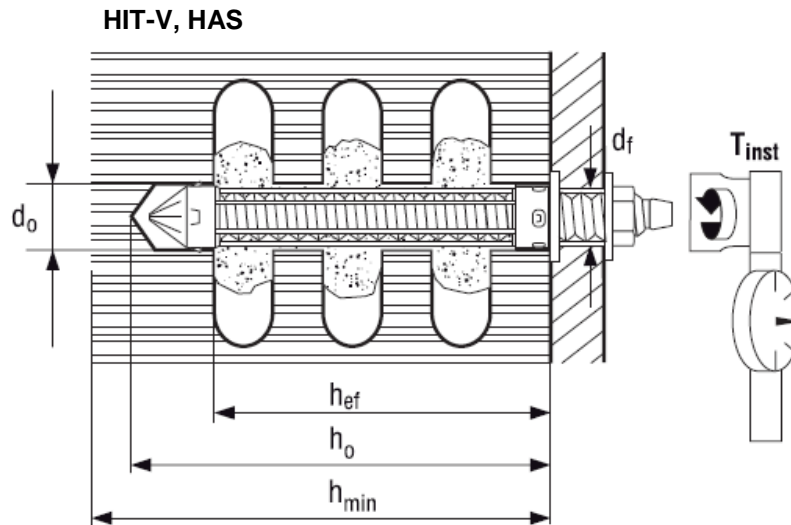
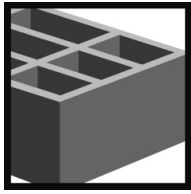

Setting details HIT-V / HAS with sieve sleeve

Anchor size			M6		M8		M10		M12			
Sieve sleeve HIT SC			12x50	12x85	16x50	16x85	16x50	16x85	18x50	18x85	22x50	22x85
Nominal diameter of drill bit	d_0	[mm]	12	12	16	16	16	16	18	18	22	22
Effective anchorage depth	h_{ef}	[mm]	50	80	50	80	50	80	50	80	50	80
Hole depth	h_0	[mm]	60	95	60	95	60	95	60	95	60	95
Minimum base material thickness	h_{min}	[mm]	80	115	80	115	80	115	80	115	80	115
Diameter of clearance hole in the fixture	d_f	[mm]	7	7	9	9	12	12	14	14	14	14
Minimum spacing ^{a)}	s_{min}	[mm]	100	100	100	100	100	100	100	100	100	100
Minimum edge distance ^{a)}	c_{min}	[mm]	100	100	100	100	100	100	100	100	100	100
Torque moment	T_{inst}	[Nm]	3	3	3	3	4	4	6	6	6	6
Filling volume		[ml]	12	24	18	30	18	30	18	36	30	55

Setting details: hole depth h_0 and effective anchorage depth in hollow base materials
HIT-IC with HIT-SC

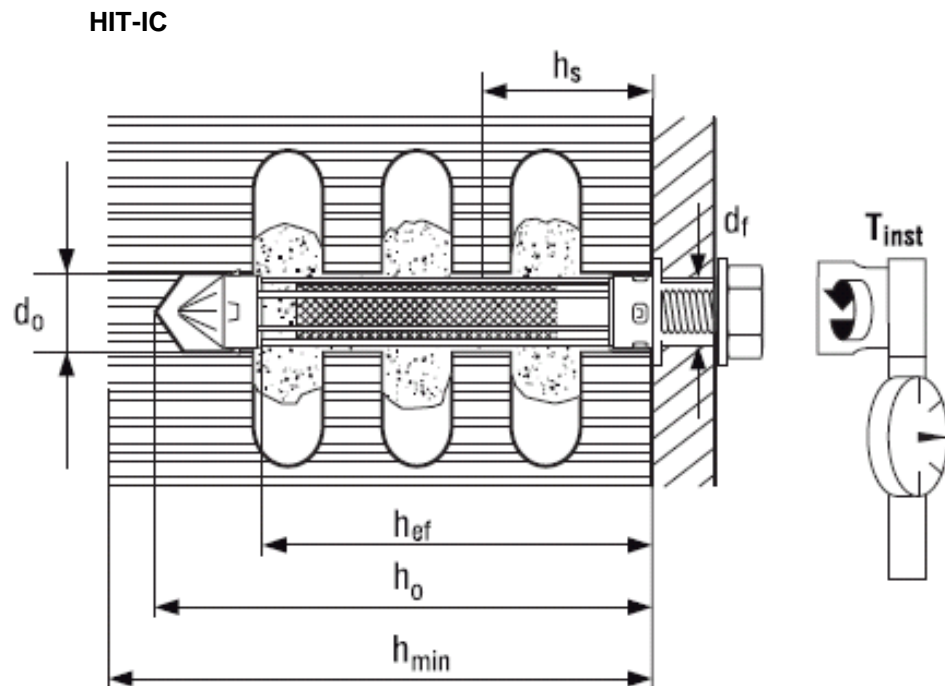
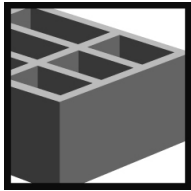

Setting details HIT-IC with sieve sleeve

Anchor size			HIT-IC		
			M8	M10	M12
Sieve sleeve HIT SC			16x85	18x85	22x85
Nominal diameter of drill bit	d_0	[mm]	16	18	22
Effective anchorage depth	h_{ef}	[mm]	80	80	80
Hole depth	h_0	[mm]	95	95	95
Minimum base material thickness	h_{min}	[mm]	115	115	115
Diameter of clearance hole in the fixture	d_f	[mm]	9	12	14
Length of bolt engagement	h_s	[mm]	min. 10 – max. 75		
Minimum spacing ^{a)}	s_{min}	[mm]	100	100	100
Minimum edge distance ^{a)}	c_{min}	[mm]	100	100	100
Torque moment	T_{inst}	[Nm]	3	4	6
Filling volume		[ml]	30	36	45

a) In case of **shear loads towards a free edge: $c_{min} = 20$ cm**

A distance from the edge of a broken brick of $c_{min} = 20$ cm is recommended, e.g. around window or door frames.

Hilti HIT-CT 1 mortar with HIT-V rod

Injection mortar system	Benefits
 <p>Hilti HIT-CT 1 330 ml foil pack (also available as 500 ml foil pack)</p> <p>Static mixer</p> <p>HIT-V(-F) rods HIT-V-R rods HIT-V-HCR rods</p>	<ul style="list-style-type: none"> - Clean-Tec technology: HIT-CT 1 mortar contains no hazardous labels and protects users and the environment in the event of contact with the mortar . - SAFEset technology: drilling and borehole cleaning in one step with Hilti hollow drill bit - suitable for non-cracked concrete C 20/25 to C 50/60 - suitable for dry and water saturated concrete - high loading capacity - rapid curing - in service temperature range up to 80°C short term/50°C long term - manual cleaning for anchor size M8 to M16 and embedment depth $8d \leq h_{ef} \leq 10d$ - compressed air cleaning for anchor size M8 to M25 and embedment depth $8d \leq h_{ef} \leq 12d$

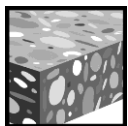

Concrete

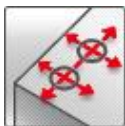

Small edge distance and spacing

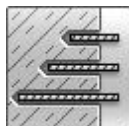

Variable embedment depth

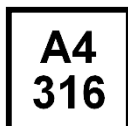

Corrosion resistance



High corrosion resistance



Hilti Clean technology

SAFEset

Hilti **SAFEset** technology with hollow drill bit



European Technical Approval



CE conformity



PROFIS Anchor design software

Approvals / certificates

Description	Authority / Laboratory	No. / date of issue
European technical approval ^{a)}	CSTB, Paris	ETA-11/0354 / 2012-08-27

a) All data given in this section according ETA-11/0354 issue 2012-08-27.

Basic loading data (for a single anchor)

All data in this section applies to

For details see Simplified design method

- Correct setting (See setting instruction)
- No edge distance and spacing influence
- Steel failure
- Base material thickness, as specified in the table
- One typical embedment depth, as specified in the table
- One anchor material, as specified in the tables
- Concrete C 20/25, $f_{ck,cube} = 25 \text{ N/mm}^2$
- Temperate range I
(min. base material temperature -40°C , max. long term/short term base material temperature: $+24^\circ\text{C}/40^\circ\text{C}$)
- Installation temperature range -5°C to $+40^\circ\text{C}$

Embedment depth ^{a)} and base material thickness for the basic loading data.

Mean ultimate resistance, characteristic resistance, design resistance, recommended loads.

Anchor size	M8	M10	M12	M16	M20	M24
Typical embedment depth h_{ef} [mm]	80	90	110	130	170	210
Base material thickness h [mm]	110	120	140	170	220	270

a) The allowed range of embedment depth is shown in the setting details. The corresponding load values can be calculated according to the simplified design method.

Mean ultimate resistance: non-cracked concrete C 20/25 , anchor HIT-V 5.8

Anchor size	M8	M10	M12	M16	M20	M24
Tensile $N_{Ru,m}$ HIT-V 5.8 [kN]	18,9	30,5	44,1	87,1	135,3	190,0
Shear $V_{Ru,m}$ HIT-V 5.8 [kN]	9,5	15,8	22,1	41,0	64,1	92,4

Characteristic resistance: non-cracked concrete C 20/25 , anchor HIT-V 5.8

Anchor size	M8	M10	M12	M16	M20	M24
Tensile N_{Rk} HIT-V 5.8 [kN]	18,0	29,0	42,0	65,3	101,5	142,5
Shear V_{Rk} HIT-V 5.8 [kN]	9,0	15,0	21,0	39,0	61,0	88,0

Design resistance: non-cracked concrete C 20/25 , anchor HIT-V 5.8

Anchor size	M8	M10	M12	M16	M20	M24
Tensile N_{Rd} HIT-V 5.8 [kN]	12,0	17,3	25,3	36,3	56,4	79,2
Shear V_{Rd} HIT-V 5.8 [kN]	7,2	12,0	16,8	31,2	48,8	70,4

Recommended loads ^{a)}: non-cracked concrete C 20/25 , anchor HIT-V 5.8

Anchor size	M8	M10	M12	M16	M20	M24
Tensile N_{rec} HIT-V 5.8 [kN]	8,6	12,3	18,1	25,9	40,3	56,5
Shear V_{rec} HIT-V 5.8 [kN]	5,1	8,6	12,0	22,3	34,9	50,3

a) With overall partial safety factor for action $\gamma = 1,4$. The partial safety factors for action depend on the type of loading and shall be taken from national regulations. According ETAG 001, annex C, the partial safety factor is $\gamma_G = 1,35$ for permanent actions and $\gamma_Q = 1,5$ for variable actions.

Service temperature range

Hilti HIT-CT 1 injection mortar may be applied in the temperature ranges given below. An elevated base material temperature may lead to a reduction of the design bond resistance.

Temperature range	Base material temperature	Maximum long term base material temperature	Maximum short term base material temperature
Temperature range I	-40 °C to +40 °C	+24 °C	+40 °C
Temperature range II	-40 °C to +80 °C	+50 °C	+80 °C

Max short term base material temperature

Short-term elevated base material temperatures are those that occur over brief intervals, e.g. as a result of diurnal cycling.

Max long term base material temperature

Long-term elevated base material temperatures are roughly constant over significant periods of time.

Materials

Mechanical properties of HIT-V

Anchor size			M8	M10	M12	M16	M20	M24
Nominal tensile strength f_{uk}	HIT-V(-F) 5.8	[N/mm ²]	500	500	500	500	500	500
	HIT-V(-F) 8.8	[N/mm ²]	800	800	800	800	800	800
	HIT-V -R	[N/mm ²]	700	700	700	700	700	700
	HIT-V -HCR	[N/mm ²]	800	800	800	800	800	700
Yield strength f_{yk}	HIT-V(-F) 5.8	[N/mm ²]	400	400	400	400	400	400
	HIT-V(-F) 8.8	[N/mm ²]	640	640	640	640	640	640
	HIT-V -R	[N/mm ²]	450	450	450	450	450	450
	HIT-V -HCR	[N/mm ²]	600	600	600	600	600	400
Stressed cross-section A_s	HIT-V	[mm ²]	36,6	58,0	84,3	157	245	353
Moment of resistance W	HIT-V	[mm ³]	31,2	62,3	109	277	541	935

Material quality

Part	Material
Threaded rod HIT-V(-F) 5.8	Strength class 5.8, A ₅ > 8% ductile steel galvanized ≥ 5 μm (-F) hot dipped galvanized ≥ 45 μm
Threaded rod HIT-V(-F) 8.8	Strength class 8.8, A ₅ > 8% ductile steel galvanized ≥ 5 μm (-F) hot dipped galvanized ≥ 45 μm (M8-M16 only)
Threaded rod HIT-V-R	Stainless steel grade A4, A ₅ > 8% ductile strength class 70 for ≤ M24 1.4401; 1.4404; 1.4578; 1.4571; 1.4439; 1.4362
Threaded rod HIT-V-HCR	High corrosion resistant steel, 1.4529; 1.4565 strength ≤ M20: R _m = 800 N/mm ² , R _{p0.2} = 640 N/mm ² , A ₅ > 8% ductile M24: R _m = 700 N/mm ² , R _{p0.2} = 400 N/mm ² , A ₅ > 8% ductile
Washer ISO 7089	Steel galvanized, hot dipped galvanized
	Stainless steel, 1.4401; 1.4404; 1.4578; 1.4571; 1.4439; 1.4362
	High corrosion resistant steel, 1.4529; 1.4565
Nut EN ISO 4032	Strength class 8 steel galvanized ≥ 5 μm hot dipped galvanized ≥ 45 μm
	Strength class 70, stainless steel grade A4, 1.4401; 1.4404; 1.4578; 1.4571; 1.4439; 1.4362
	Strength class 70, EN ISO 3506-2, high corrosion resistant steel, 1.4529; 1.4565

Anchor dimensions

Anchor size	M8	M10	M12	M16	M20	M24
Anchor rod HIT-V, HIT-V-F HIT-V-R, HIT-V-HCR	Anchor rods HIT-V (-F/ -R / -HCR) are available in variable length					

Setting instruction

Dry and water-saturated concrete, hammer drilling

Bore hole drilling

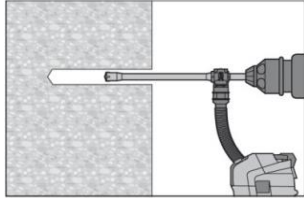

Drill hole to the required embedment depth with an appropriately sized Hilti TE-CD or TE-YD hollow drill bit with Hilti vacuum attachment. This drilling method properly cleans the borehole and removes dust while drilling. After drilling is complete, proceed to the "injection preparation" step in the instructions for use.

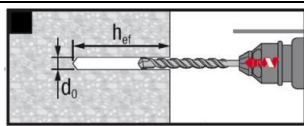

Drill hole to the required embedment depth with a hammer drill set in rotation-hammer mode using an appropriately sized carbide drill bit.

Bore hole cleaning

Just before setting an anchor, the bore hole must be free of dust and debris by one of two cleaning methods described below:

a) Compressed air cleaning (CAC)

For all bore hole diameters d_0 and all bore hole depth h_0

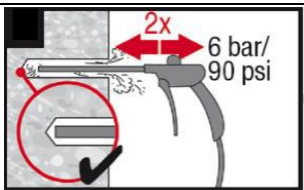

Blow 2 times from the back of the hole (if needed with nozzle extension) over the hole length with oil-free compressed air (min. 6 bar at 6 m³/h) until return air stream is free of noticeable dust.

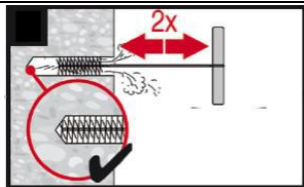

Brush 2 times with the specified brush size (brush $\varnothing \geq$ bore hole \varnothing , see Table 5) by inserting the steel brush Hilti HIT-RB to the back of the hole (if needed with extension) in a twisting motion and removing it. The brush must produce natural resistance as it enters the bore hole -- if not, the brush is too small and must be replaced with the proper brush diameter.

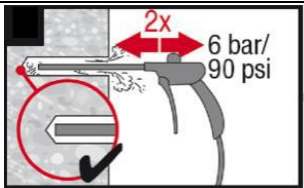

Blow again with compressed air 2 times until return air stream is free of noticeable dust.

b) Manual Cleaning (MC)

As an alternative to compressed air cleaning, a manual cleaning is permitted for hammer drilled boreholes for bore hole diameters $d_0 \leq 20\text{mm}$ and bore hole depth $h_0 \leq 10d_s$. The borehole must be free of dust, debris, water, ice, oil, grease and other contaminants prior to mortar injection.

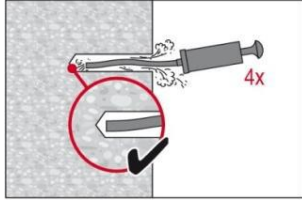

The Hilti manual pump may be used for blowing out bore holes up to diameters $d_0 \leq 20\text{ mm}$ and embedment depths up to $h_{ef} \leq 10d_s$. Blow out at least 4 times from the back of the bore hole until return air stream is free of noticeable dust.

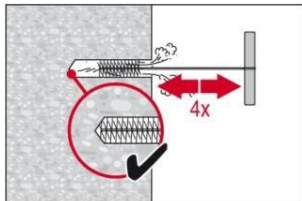

Brush 4 times with the specified brush size (brush $\varnothing \geq$ bore hole \varnothing , see Table 5) by inserting the steel brush Hilti HIT-RB to the back of the hole (if needed with extension) in a twisting motion and removing it. The brush must produce natural resistance as it enters the bore hole -- if not, the brush is too small and must be replaced with the proper brush diameter.

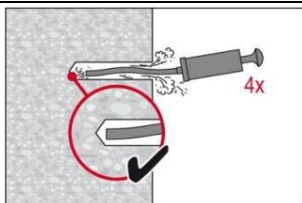

Blow out again with manual pump at least 4 times until return air stream is free of noticeable dust.

Injection preparation

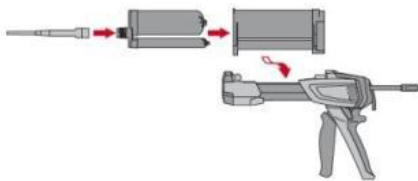

Observe the Instruction for Use of the dispenser.
Observe the Instruction for Use of the mortar.
Tightly attach Hilti HIT-RE-M mixing nozzle to foil pack manifold.
Insert foil pack into foil pack holder and swing holder into the dispenser.

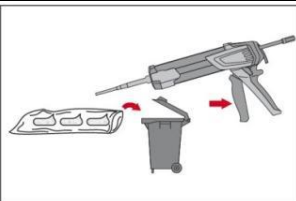

Discard initial adhesive. The foil pack opens automatically as dispensing is initiated. Depending on the size of the foil pack an initial amount of adhesive has to be discarded.

Discard quantities are
2 strokes for 330 ml foil pack
3 strokes for 500 ml foil pack

Inject adhesive from the back of the borehole without forming air voids

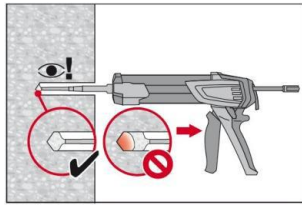

Injection method for borehole depth ≤ 250 mm:

Inject the mortar from the back of the hole towards the front and slowly withdraw the mixing nozzle step by step after each trigger pull. **Important!** Use extensions for deep holes > 250 mm. Fill holes approximately 2/3 full, or as required to ensure that the annular gap between the rebar and the concrete is completely filled with adhesive over the embedment length.

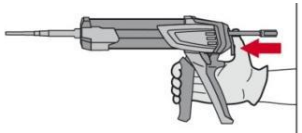

After injecting, depressurize the dispenser by pressing the release trigger (only for manual dispenser). This will prevent further mortar discharge from the mixing nozzle.

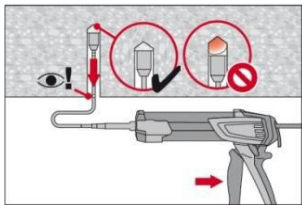

Piston plug injection for borehole depth > 250 mm or overhead applications:

Assemble mixing nozzle, extension(s) and appropriately sized piston plug. Insert piston plug to back of the hole. Begin injection allowing the pressure of the injected adhesive mortar to push the piston plug towards the front of the hole. After injecting, depressurize the dispenser by pressing the release trigger. This will prevent further mortar discharge from the mixing nozzle. The proper injection of mortar using a piston plug HIT-SZ prevents the creation of air voids. The piston plug must be insertable to the back of the borehole without resistance. During injection the piston plug will be pressed towards the front of the borehole slowly by mortar pressure. Attention! Pulling the injection or when changing the foil pack, the piston plug is rendered inactive and air voids may occur.

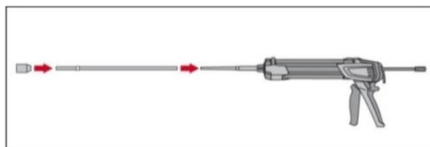

Dispenser types with related foil pack sizes:

HDM 330	Manual dispenser (330 ml)
HDM 500	Manual dispenser (330 / 500 ml)
HDE 500-A22	Electric dispenser (330 / 500 ml)

Setting the element

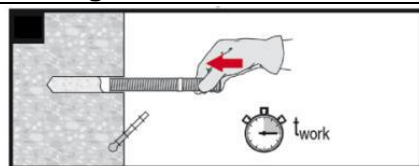

Before use, verify that the element is dry and free of oil and other contaminants. Mark and set element to the required embedment depth till working time t_{work} has elapsed. The working time t_{work} is given in the table below.

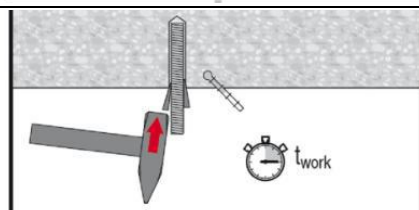

For overhead installation use piston plugs and fix embedded parts with e.g. wedges.

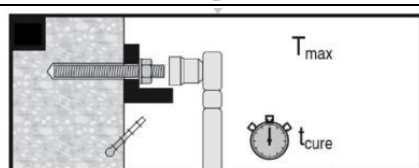

Loading the anchor: After required curing time t_{cure} (see Table below) the anchor can be loaded.

For detailed information on installation see instruction for use given with the package of the product.

Working time, Curing time

Temperature of the base material T_{BM}	Working time t_{gel}	Curing time $t_{cure}^{a)}$
$-5\text{ °C} \leq T_{BM} < 0\text{ °C}$	60 min	6 h
$0\text{ °C} \leq T_{BM} < 5\text{ °C}$	40 min	3 h
$5\text{ °C} \leq T_{BM} < 10\text{ °C}$	25 min	2 h
$10\text{ °C} \leq T_{BM} < 20\text{ °C}$	10 min	90 min
$20\text{ °C} \leq T_{BM} < 30\text{ °C}$	4 min	75 min
$30\text{ °C} \leq T_{BM} \leq 40\text{ °C}$	2 min	60 min

a) The curing time data are valid for dry anchorage base only. For water saturated anchorage bases the curing times must be doubled.

Setting

installation equipment

Anchor size	M8	M10	M12	M16	M20	M24
Rotary hammer	TE 2 – TE 16				TE 40 – TE 70	
Other tools	compressed air gun or blow out pump, set of cleaning brushes, dispenser					

Setting details

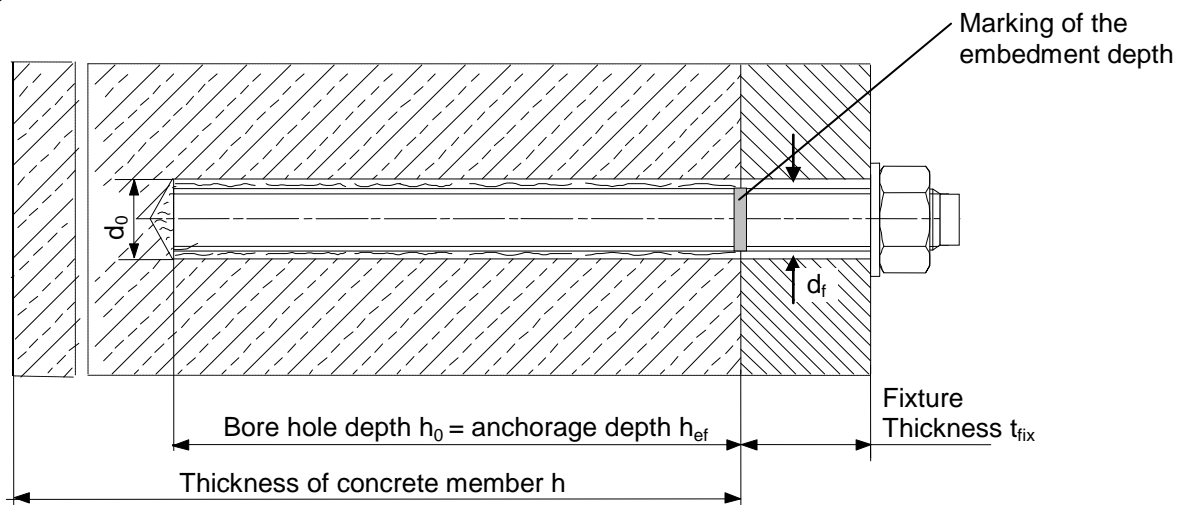

Setting details

Anchor size		M8	M10	M12	M16	M20	M24
Nominal diameter of drill bit	d_0 [mm]	10	12	14	18	22	28
Effective embedment and drill hole depth range ^{a)} for HIT-V	$h_{ef,min}$ [mm]	64	80	96	128	160	192
	$h_{ef,max}$ [mm]	96	120	144	192	240	288
Minimum base material thickness	h_{min} [mm]	$h_{ef} + 30 \text{ mm}$ $\geq 100 \text{ mm}$			$h_{ef} + 2 d_0$		
Diameter of clearance hole in the fixture	d_f [mm]	9	12	14	18	22	26
Torque moment	$T_{max}^{b)}$ [Nm]	10	20	40	80	150	200
Minimum spacing	s_{min} [mm]	40	50	60	80	100	120
Minimum edge distance	c_{min} [mm]	40	50	60	80	100	120
Critical spacing for splitting failure	$s_{cr,sp}$ [mm]	$2 c_{cr,sp}$					
Critical edge distance for splitting failure ^{c)}	$c_{cr,sp}$ [mm]	$1,0 \cdot h_{ef}$ for $h / h_{ef} \geq 2,0$					
		$4,6 h_{ef} - 1,8 h$ for $2,0 > h / h_{ef} > 1,3$:					
		$2,26 h_{ef}$ for $h / h_{ef} \leq 1,3$:					
Critical spacing for concrete cone failure	$s_{cr,N}$ [mm]	$2 c_{cr,N}$					
Critical edge distance for concrete cone failure ^{d)}	$c_{cr,N}$ [mm]	$1,5 h_{ef}$					

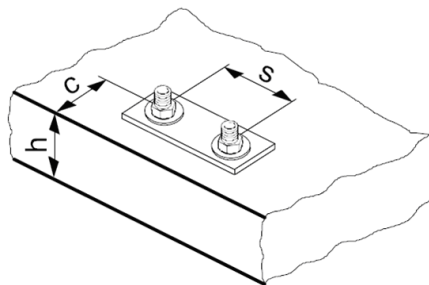

For spacing (or edge distance) smaller than critical spacing (or critical edge distance) the design loads have to be reduced.

- a) Embedment depth range: $h_{ef,min} \leq h_{ef} \leq h_{ef,max}$
- b) Maximum recommended torque moment to avoid splitting failure during installation with minimum spacing and/or edge distance.
- c) h : base material thickness ($h \geq h_{min}$), h_{ef} : embedment depth
- d) The critical edge distance for concrete cone failure depends on the embedment depth h_{ef} and the design bond resistance. The simplified formula given in this table is on the safe side.

Simplified design method

Simplified version of the design method according ETAG 001, TR 029. Design resistance according data given in ETA-08/0341, issue 2008-12-02.

- Influence of concrete strength
- Influence of edge distance
- Influence of spacing
- Valid for a group of two anchors. (The method may also be applied for anchor groups with more than two anchors or more than one edge distance. The influencing factors must then be considered for each edge distance and spacing. The calculated design loads are then on the safe side: They will be lower than the exact values according ETAG 001, TR 029. To avoid this, it is recommended to use the anchor design software PROFIS anchor)

The design method is based on the following simplification:

- No different loads are acting on individual anchors (no eccentricity)

The values are valid for one anchor.

For more complex fastening applications please use the anchor design software PROFIS Anchor.

Tension loading

The design tensile resistance is the lower value of

- Steel resistance: $N_{Rd,s}$
- Combined pull-out and concrete cone resistance: $N_{Rd,p} = N_{Rd,p}^0 \cdot f_{B,p} \cdot f_{1,N} \cdot f_{2,N} \cdot f_{3,N} \cdot f_{h,p} \cdot f_{re,N}$
- Concrete cone resistance: $N_{Rd,c} = N_{Rd,c}^0 \cdot f_B \cdot f_{1,N} \cdot f_{2,N} \cdot f_{3,N} \cdot f_{h,N} \cdot f_{re,N}$
- Concrete splitting resistance (only non-cracked concrete): $N_{Rd,sp} = N_{Rd,c}^0 \cdot f_B \cdot f_{1,sp} \cdot f_{2,sp} \cdot f_{3,sp} \cdot f_{h,N} \cdot f_{re,N}$

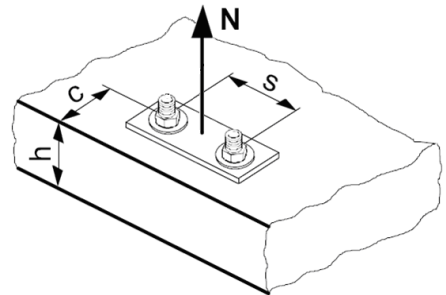

Basic design tensile resistance

Design steel resistance $N_{Rd,s}$

Anchor size		M8	M10	M12	M16	M20	M24
$N_{Rd,s}$	HIT-V(-F) 5.8 [kN]	12,0	19,3	28,0	52,7	82,0	118,0
	HIT-V(-F) 8.8 [kN]	19,3	30,7	44,7	84,0	130,7	188,0
	HIT-V-R [kN]	13,9	21,9	31,6	58,8	92,0	132,1
	HIT-V-HCR [kN]	19,3	30,7	44,7	84,0	130,7	117,6

Design combined pull-out and concrete cone resistance

$$N_{Rd,p} = N_{Rd,p}^0 \cdot f_{B,p} \cdot f_{1,N} \cdot f_{2,N} \cdot f_{3,N} \cdot f_{h,p} \cdot f_{re,N}$$

Anchor size		M8	M10	M12	M16	M20	M24
Typical embedment depth $h_{ef} = h_{ef,typ}$ [mm]		80	90	110	130	170	210
$N_{Rd,p}^0$ Temperature range I [kN]		13,4	17,3	25,3	36,3	56,4	79,2
$N_{Rd,p}^0$ Temperature range II [kN]		12,3	17,3	23,0	34,5	53,4	74,8

Design concrete cone resistance $N_{Rd,c} = N_{Rd,c}^0 \cdot f_B \cdot f_{1,N} \cdot f_{2,N} \cdot f_{3,N} \cdot f_{h,N} \cdot f_{re,N}$

Design splitting resistance $N_{Rd,sp} = N_{Rd,c}^0 \cdot f_B \cdot f_{1,sp} \cdot f_{2,sp} \cdot f_{3,sp} \cdot f_{h,N} \cdot f_{re,N}$

Anchor size		M8	M10	M12	M16	M20	M24
$N_{Rd,c}^0$ [kN]		20,1	24,0	32,4	41,6	62,2	85,4

Influencing factors

Influence of concrete strength on combined pull-out and concrete cone resistance

Concrete strength designation (ENV 206)	C 20/25	C 25/30	C 30/37	C 35/45	C 40/50	C 45/55	C 50/60
$f_{B,p} = (f_{ck,cube}/25N/mm^2)^{0,15}$ ^{a)}	1,00	1,03	1,06	1,09	1,11	1,13	1,14

a) $f_{ck,cube}$ = concrete compressive strength, measured on cubes with 150 mm side length

Influence of embedment depth on combined pull-out and concrete cone resistance

$f_{h,p} = h_{ef}/h_{ef,typ}$

Influence of concrete strength on concrete cone resistance

Concrete strength designation (ENV 206)	C 20/25	C 25/30	C 30/37	C 35/45	C 40/50	C 45/55	C 50/60
$f_B = (f_{ck,cube}/25N/mm^2)^{0,5}$ ^{a)}	1	1,1	1,22	1,34	1,41	1,48	1,55

a) $f_{ck,cube}$ = concrete compressive strength, measured on cubes with 150 mm side length

Influence of edge distance ^{a)}

$c/c_{cr,N}$	0,1	0,2	0,3	0,4	0,5	0,6	0,7	0,8	0,9	1
$c/c_{cr,sp}$										
$f_{1,N} = 0,7 + 0,3 \cdot c/c_{cr,N} \leq 1$	0,73	0,76	0,79	0,82	0,85	0,88	0,91	0,94	0,97	1
$f_{1,sp} = 0,7 + 0,3 \cdot c/c_{cr,sp} \leq 1$										
$f_{2,N} = 0,5 \cdot (1 + c/c_{cr,N}) \leq 1$	0,55	0,60	0,65	0,70	0,75	0,80	0,85	0,90	0,95	1
$f_{2,sp} = 0,5 \cdot (1 + c/c_{cr,sp}) \leq 1$										

a) The edge distance shall not be smaller than the minimum edge distance c_{min} . These influencing factors must be considered for every edge distance smaller than the critical edge distance.

Influence of anchor spacing ^{a)}

$s/s_{cr,N}$	0,1	0,2	0,3	0,4	0,5	0,6	0,7	0,8	0,9	1
$s/s_{cr,sp}$										
$f_{3,N} = 0,5 \cdot (1 + s/s_{cr,N}) \leq 1$	0,55	0,60	0,65	0,70	0,75	0,80	0,85	0,90	0,95	1
$f_{3,sp} = 0,5 \cdot (1 + s/s_{cr,sp}) \leq 1$										

a) The anchor spacing shall not be smaller than the minimum anchor spacing s_{min} . This influencing factor must be considered for every anchor spacing.

Influence of embedment depth on concrete cone resistance

$f_{h,N} = (h_{ef}/h_{ef,typ})^{1,5}$

Influence of reinforcement

h_{ef} [mm]	40	50	60	70	80	90	≥ 100
$f_{re,N} = 0,5 + h_{ef}/200mm \leq 1$	0,7 ^{a)}	0,75 ^{a)}	0,8 ^{a)}	0,85 ^{a)}	0,9 ^{a)}	0,95 ^{a)}	1

a) This factor applies only for dense reinforcement. If in the area of anchorage there is reinforcement with a spacing ≥ 150 mm (any diameter) or with a diameter ≤ 10 mm and a spacing ≥ 100 mm, then a factor $f_{re,N} = 1$ may be applied.

Shear loading

The design shear resistance is the lower value of

- Steel resistance: $V_{Rd,s}$
- Concrete pryout resistance: $V_{Rd,cp} = k \cdot \text{lower value of } N_{Rd,p} \text{ and } N_{Rd,c}$
- Concrete edge resistance: $V_{Rd,c} = V_{Rd,c}^0 \cdot f_B \cdot f_{\beta} \cdot f_h \cdot f_4 \cdot f_{hef} \cdot f_c$

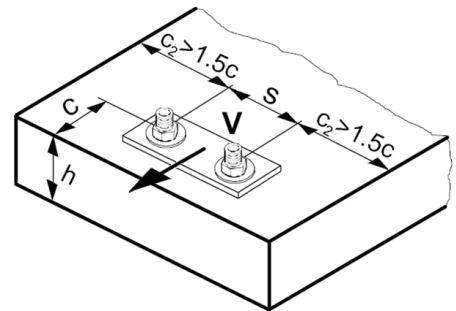

Basic design shear resistance

Design steel resistance $V_{Rd,s}$

Anchor size		M8	M10	M12	M16	M20	M24
$V_{Rd,s}$	HIT-V(-F) 5.8 [kN]	7,2	12,0	16,8	31,2	48,8	70,4
	HIT-V(-F) 8.8 [kN]	12,0	18,4	27,2	50,4	78,4	112,8
	HIT-V-R [kN]	8,3	12,8	19,2	35,3	55,1	79,5
	HIT-V-HCR [kN]	12,0	18,4	27,2	50,4	78,4	70,9

Design concrete pryout resistance $V_{Rd,cp} = \text{lower value}^a)$ of $k \cdot N_{Rd,p}$ and $k \cdot N_{Rd,c}$

$$k = 2 \text{ for } h_{ef} \geq 60 \text{ mm}$$

- a) $N_{Rd,p}$: Design combined pull-out and concrete cone resistance
 $N_{Rd,c}$: Design concrete cone resistance

Design concrete edge resistance $V_{Rd,c} = V_{Rd,c}^0 \cdot f_B \cdot f_{\beta} \cdot f_h \cdot f_4 \cdot f_{hef} \cdot f_c$

Anchor size		M8	M10	M12	M16	M20	M24
Non-cracked concrete							
$V_{Rd,c}^0$ [kN]		5,9	8,6	11,6	18,7	27,0	36,6

Influencing factors

Influence of concrete strength

Concrete strength designation (ENV 206)	C 20/25	C 25/30	C 30/37	C 35/45	C 40/50	C 45/55	C 50/60
$f_B = (f_{ck,cube}/25N/mm^2)^{1/2}$ a)	1	1,1	1,22	1,34	1,41	1,48	1,55

- a) $f_{ck,cube}$ = concrete compressive strength, measured on cubes with 150 mm side length

Influence of angle between load applied and the direction perpendicular to the free edge

Angle β	0°	10°	20°	30°	40°	50°	60°	70°	80°	≥ 90°
f_{β}	1	1,01	1,05	1,13	1,24	1,40	1,64	1,97	2,32	2,50

Influence of base material thickness

h/c	0,15	0,3	0,45	0,6	0,75	0,9	1,05	1,2	1,35	≥ 1,5
$f_h = \{h/(1,5 \cdot c)\}^{1/2} \leq 1$	0,32	0,45	0,55	0,63	0,71	0,77	0,84	0,89	0,95	1,00

Influence of anchor spacing and edge distance ^{a)} for concrete edge resistance: f_4

$$f_4 = (c/h_{ef})^{1,5} \cdot (1 + s / [3 \cdot c]) \cdot 0,5$$

c/h _{ef}	Single anchor	Group of two anchors s/h _{ef}														
		0,75	1,50	2,25	3,00	3,75	4,50	5,25	6,00	6,75	7,50	8,25	9,00	9,75	10,50	11,25
0,50	0,35	0,27	0,35	0,35	0,35	0,35	0,35	0,35	0,35	0,35	0,35	0,35	0,35	0,35	0,35	0,35
0,75	0,65	0,43	0,54	0,65	0,65	0,65	0,65	0,65	0,65	0,65	0,65	0,65	0,65	0,65	0,65	0,65
1,00	1,00	0,63	0,75	0,88	1,00	1,00	1,00	1,00	1,00	1,00	1,00	1,00	1,00	1,00	1,00	1,00
1,25	1,40	0,84	0,98	1,12	1,26	1,40	1,40	1,40	1,40	1,40	1,40	1,40	1,40	1,40	1,40	1,40
1,50	1,84	1,07	1,22	1,38	1,53	1,68	1,84	1,84	1,84	1,84	1,84	1,84	1,84	1,84	1,84	1,84
1,75	2,32	1,32	1,49	1,65	1,82	1,98	2,15	2,32	2,32	2,32	2,32	2,32	2,32	2,32	2,32	2,32
2,00	2,83	1,59	1,77	1,94	2,12	2,30	2,47	2,65	2,83	2,83	2,83	2,83	2,83	2,83	2,83	2,83
2,25	3,38	1,88	2,06	2,25	2,44	2,63	2,81	3,00	3,19	3,38	3,38	3,38	3,38	3,38	3,38	3,38
2,50	3,95	2,17	2,37	2,57	2,77	2,96	3,16	3,36	3,56	3,76	3,95	3,95	3,95	3,95	3,95	3,95
2,75	4,56	2,49	2,69	2,90	3,11	3,32	3,52	3,73	3,94	4,15	4,35	4,56	4,56	4,56	4,56	4,56
3,00	5,20	2,81	3,03	3,25	3,46	3,68	3,90	4,11	4,33	4,55	4,76	4,98	5,20	5,20	5,20	5,20
3,25	5,86	3,15	3,38	3,61	3,83	4,06	4,28	4,51	4,73	4,96	5,18	5,41	5,63	5,86	5,86	5,86
3,50	6,55	3,51	3,74	3,98	4,21	4,44	4,68	4,91	5,14	5,38	5,61	5,85	6,08	6,31	6,55	6,55
3,75	7,26	3,87	4,12	4,36	4,60	4,84	5,08	5,33	5,57	5,81	6,05	6,29	6,54	6,78	7,02	7,26
4,00	8,00	4,25	4,50	4,75	5,00	5,25	5,50	5,75	6,00	6,25	6,50	6,75	7,00	7,25	7,50	7,75
4,25	8,76	4,64	4,90	5,15	5,41	5,67	5,93	6,18	6,44	6,70	6,96	7,22	7,47	7,73	7,99	8,25
4,50	9,55	5,04	5,30	5,57	5,83	6,10	6,36	6,63	6,89	7,16	7,42	7,69	7,95	8,22	8,49	8,75
4,75	10,35	5,45	5,72	5,99	6,27	6,54	6,81	7,08	7,36	7,63	7,90	8,17	8,45	8,72	8,99	9,26
5,00	11,18	5,87	6,15	6,43	6,71	6,99	7,27	7,55	7,83	8,11	8,39	8,66	8,94	9,22	9,50	9,78
5,25	12,03	6,30	6,59	6,87	7,16	7,45	7,73	8,02	8,31	8,59	8,88	9,17	9,45	9,74	10,02	10,31
5,50	12,90	6,74	7,04	7,33	7,62	7,92	8,21	8,50	8,79	9,09	9,38	9,67	9,97	10,26	10,55	10,85

a) The anchor spacing and the edge distance shall not be smaller than the minimum anchor spacing s_{min} and the minimum edge distance c_{min} .

Influence of embedment depth

h_{ef}/d	4	4,5	5	6	7	8	9	10	11
$f_{hef} = 0,05 \cdot (h_{ef} / d)^{1,68}$	0,51	0,63	0,75	1,01	1,31	1,64	2,00	2,39	2,81
h_{ef}/d	12	13	14	15	16	17	18	19	20
$f_{hef} = 0,05 \cdot (h_{ef} / d)^{1,68}$	3,25	3,72	4,21	4,73	5,27	5,84	6,42	7,04	7,67

Influence of edge distance ^{a)}

c/d	4	6	8	10	15	20	30	40
$f_c = (d / c)^{0,19}$	0,77	0,71	0,67	0,65	0,60	0,57	0,52	0,50

a) The edge distance shall not be smaller than the minimum edge distance c_{min} .

Combined tension and shear loading

For combined tension and shear loading see section "Anchor Design".

Precalculated values – design resistance values

All data applies to:

- non-cracked concrete C 20/25 – $f_{ck,cube} = 25 \text{ N/mm}^2$
- temperature range I (see Service temperature range)
- minimum thickness of base material
- no effects of dense reinforcement

Design resistance: concrete C 20/25 – $f_{ck,cube} = 25 \text{ N/mm}^2$ - minimum embedment depth

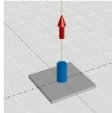
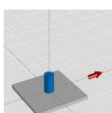
Anchor size	M8	M10	M12	M16	M20	M24
Embedment depth $h_{ef} = h_{ef,min}$ [mm]	64	80	96	128	160	192
Base material thickness $h = h_{min}$ [mm]	100	110	126	164	204	248
 Tensile N_{Rd}: single anchor, no edge effects						
HIT-V(-F) 5.8						
HIT-V(-F) 8.8						
HIT-V-R	[kN]	10,7	15,4	22,1	35,7	53,1
HIT-V-HCR						72,4
 Shear V_{Rd}: single anchor, no edge effects, without lever arm						
HIT-V(-F) 5.8	[kN]	7,2	12,0	16,8	31,2	48,8
HIT-V(-F) 8.8	[kN]	12,0	18,4	27,2	50,4	78,4
HIT-V-R	[kN]	8,3	12,8	19,2	35,3	55,1
HIT-V-HCR	[kN]	12,0	18,4	27,2	50,4	78,4

Design resistance: concrete C 20/25 – $f_{ck,cube} = 25 \text{ N/mm}^2$ - minimum embedment depth

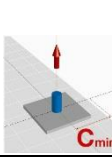
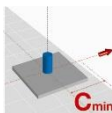
Anchor size	M8	M10	M12	M16	M20	M24
Embedment depth $h_{ef} = h_{ef,min}$ [mm]	64	80	96	128	160	192
Base material thickness $h = h_{min}$ [mm]	100	110	126	164	204	248
Edge distance $c = c_{min}$ [mm]	40	50	60	80	100	120
 Tensile N_{Rd}: single anchor, min. edge distance ($c = c_{min}$)						
HIT-V(-F) 5.8						
HIT-V(-F) 8.8	[kN]	6,3	9,0	12,9	21,3	31,9
HIT-V-R						43,6
HIT-V-HCR						
 Shear V_{Rd}: single anchor, min. edge distance ($c = c_{min}$), without lever arm						
HIT-V(-F) 5.8						
HIT-V(-F) 8.8	[kN]	3,6	5,2	7,1	11,6	16,9
HIT-V-R						23,0
HIT-V-HCR						

**Design resistance: concrete C 20/25 – $f_{ck,cube} = 25 \text{ N/mm}^2$ - minimum embedment depth
(load values are valid for single anchor)**

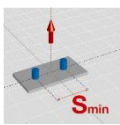
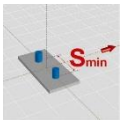
Anchor size		M8	M10	M12	M16	M20	M24	
Embedment depth $h_{ef} = h_{ef,min}$ [mm]		64	80	96	128	160	192	
Base material thickness $h = h_{min}$ [mm]		100	110	126	164	204	248	
Spacing $s = s_{min}$ [mm]		40	50	60	80	100	120	
	Tensile N_{Rd}: double anchor, no edge effects, min. spacing ($s = s_{min}$)							
	HIT-V(-F) 5.8							
	HIT-V(-F) 8.8	[kN]	7,0	10,0	14,0	22,6	33,1	44,8
	HIT-V-R HIT-V-HCR							
	Shear V_{Rd}: double anchor, no edge effects, min. spacing ($s = s_{min}$), without lever arm							
	HIT-V(-F) 5.8	[kN]	7,2	12,0	16,8	31,2	48,8	70,4
	HIT-V(-F) 8.8	[kN]	12,0	18,4	26,7	43,2	64,1	87,5
	HIT-V-R	[kN]	8,3	12,8	19,2	35,3	55,1	79,5
	HIT-V-HCR	[kN]	12,0	18,4	26,7	43,2	64,1	70,9

Design resistance: concrete C 20/25 – $f_{ck,cube} = 25 \text{ N/mm}^2$ - typical embedment depth

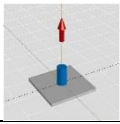
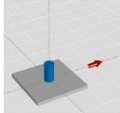
Anchor size		M8	M10	M12	M16	M20	M24	
Embedment depth $h_{ef} = h_{ef,typ}$ [mm]		80	90	110	130	170	210	
Base material thickness $h = h_{min}$ [mm]		110	120	140	166	214	266	
	Tensile N_{Rd}: single anchor, no edge effects							
	HIT-V(-F) 5.8	[kN]	12,0	17,3	25,3	36,3	56,4	79,2
	HIT-V(-F) 8.8							
	HIT-V-R HIT-V-HCR	[kN]	13,4	17,3	25,3	36,3	56,4	79,2
	Shear V_{Rd}: single anchor, no edge effects, without lever arm							
	HIT-V(-F) 5.8	[kN]	7,2	12,0	16,8	31,2	48,8	70,4
	HIT-V(-F) 8.8	[kN]	12,0	18,4	27,2	50,4	78,4	112,8
	HIT-V-R	[kN]	8,3	12,8	19,2	35,3	55,1	79,5
	HIT-V-HCR	[kN]	12,0	18,4	27,2	50,4	78,4	70,9

Design resistance: concrete C 20/25 – $f_{ck,cube} = 25 \text{ N/mm}^2$ - typical embedment depth

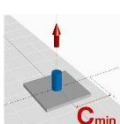
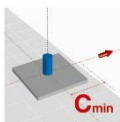
Anchor size		M8	M10	M12	M16	M20	M24	
Embedment depth $h_{ef} = h_{ef,typ}$ [mm]		80	90	110	130	170	210	
Base material thickness $h = h_{min}$ [mm]		110	120	140	166	214	266	
Edge distance $c = c_{min}$ [mm]		40	50	60	80	100	120	
	Tensile N_{Rd}: single anchor, min. edge distance ($c = c_{min}$)							
	HIT-V(-F) 5.8							
	HIT-V(-F) 8.8	[kN]	7,7	10,1	14,7	21,6	33,9	48,0
	HIT-V-R HIT-V-HCR							
	Shear V_{Rd}: single anchor, min. edge distance ($c = c_{min}$), without lever arm							
	HIT-V(-F) 5.8							
	HIT-V(-F) 8.8	[kN]	3,7	5,3	7,3	11,6	17,2	23,6
	HIT-V-R							
	HIT-V-HCR							

Design resistance: concrete C 20/25 – $f_{ck,cube} = 25 \text{ N/mm}^2$ - typical embedment depth (load values are valid for single anchor)

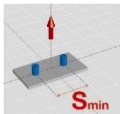
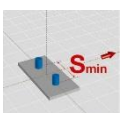
Anchor size		M8	M10	M12	M16	M20	M24	
Embedment depth $h_{ef} = h_{ef,typ}$ [mm]		80	90	110	130	170	210	
Base material thickness $h = h_{min}$ [mm]		110	120	140	166	214	266	
Spacing s [mm]		40	50	60	80	100	120	
	Tensile N_{Rd}: double anchor, no edge effects, min. spacing ($s = s_{min}$)							
	HIT-V(-F) 5.8 HIT-V(-F) 8.8 HIT-V-R HIT-V-HCR	[kN]	8,9	11,3	16,3	23,0	35,4	49,7
	Shear V_{Rd}: double anchor, no edge effects, min. spacing ($s = s_{min}$), without lever arm							
	HIT-V(-F) 5.8 HIT-V(-F) 8.8 HIT-V-R HIT-V-HCR	[kN]	7,2	12,0	16,8	31,2	48,8	70,4
		[kN]	12,0	18,4	27,2	43,7	67,4	94,2
		[kN]	8,3	12,8	19,2	35,3	55,1	79,5
		[kN]	12,0	18,4	27,2	43,7	67,4	70,9

Design resistance: concrete C 20/25 – $f_{ck,cube} = 25 \text{ N/mm}^2$ - embedment depth = $12 d^a$)

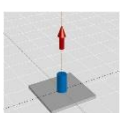
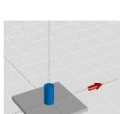
Anchor size		M8	M10	M12	M16	M20	M24	
Embedment depth $h_{ef} = 12 d^a$) [mm]		96	120	144	192	240	288	
Base material thickness $h = h_{min}$ [mm]		126	150	174	228	288	344	
	Tensile N_{Rd}: single anchor, no edge effects							
	HIT-V(-F) 5.8 HIT-V(-F) 8.8 HIT-V-R HIT-V-HCR	[kN]	12,0	19,3	28,0	52,7	79,6	108,6
		[kN]	16,1	23,0	33,2	53,6	79,6	108,6
		[kN]	13,9	21,9	31,6	53,6	79,6	108,6
		[kN]	16,1	23,0	33,2	53,6	79,6	108,6
	Shear V_{Rd}: single anchor, no edge effects, without lever arm							
	HIT-V(-F) 5.8 HIT-V(-F) 8.8 HIT-V-R HIT-V-HCR	[kN]	7,2	12,0	16,8	31,2	48,8	70,4
		[kN]	12,0	18,4	27,2	50,4	78,4	112,8
		[kN]	8,3	12,8	19,2	35,3	55,1	79,5
		[kN]	12,0	18,4	27,2	50,4	78,4	70,9

a) d = element diameter

Design resistance: concrete C 20/25 – $f_{ck,cube} = 25 \text{ N/mm}^2$ - embedment depth = $12 d^a$)

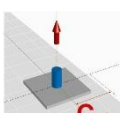
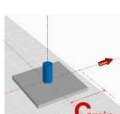
Anchor size		M8	M10	M12	M16	M20	M24	
Embedment depth $h_{ef} = 12 d^a$) [mm]		96	120	144	192	240	288	
Base material thickness $h = h_{min}$ [mm]		126	150	174	228	284	344	
Edge distance $c = c_{min}$ [mm]		40	50	60	80	100	120	
	Tensile N_{Rd}: single anchor, min. edge distance ($c = c_{min}$)							
	HIT-V(-F) 5.8 HIT-V(-F) 8.8 HIT-V-R HIT-V-HCR	[kN]	9,2	13,4	19,3	31,9	47,9	66,2
	Shear V_{Rd}: single anchor, min. edge distance ($c = c_{min}$), without lever arm							
	HIT-V(-F) 5.8 HIT-V(-F) 8.8 HIT-V-R HIT-V-HCR	[kN]	3,9	5,7	7,8	12,9	18,9	25,9

a) d = element diameter

Design resistance: concrete C 20/25 – $f_{ck,cube} = 25 \text{ N/mm}^2$ - embedment depth = $12 d^a$
(load values are valid for single anchor)

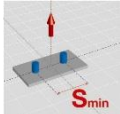
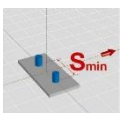
Anchor size		M8	M10	M12	M16	M20	M24	
Embedment depth $h_{ef} = 12 d^a$ [mm]		96	120	144	192	240	288	
Base material thickness $h = h_{min}$ [mm]		126	150	174	228	284	344	
Spacing $s = s_{min}$ [mm]		40	50	60	80	100	120	
	Tensile N_{Rd}: double anchor, no edge effects, min. spacing ($s = s_{min}$)							
	HIT-V(-F) 5.8							
	HIT-V(-F) 8.8							
	HIT-V-R	[kN]	10,8	15,5	22,0	35,4	52,1	70,9
	HIT-V-HCR							
	Shear V_{Rd}: double anchor, no edge effects, min. spacing ($s = s_{min}$), without lever arm							
	HIT-V(-F) 5.8	[kN]	7,2	12,0	16,8	31,2	48,8	70,4
	HIT-V(-F) 8.8	[kN]	12,0	18,4	27,2	50,4	78,4	112,8
	HIT-V-R	[kN]	8,3	12,8	19,2	35,3	55,1	79,5
	HIT-V-HCR	[kN]	12,0	18,4	27,2	50,4	78,4	70,9

a) d = element diameter

Precalculated values – recommended load values

All data applies to:

- non-cracked concrete C 20/25 – $f_{ck,cube} = 25 \text{ N/mm}^2$
- temperature range I (see Service temperature range)
- minimum thickness of base material
- no effects of dense reinforcement

Recommended loads: non-cracked concrete C 20/25 - minimum embedment depth

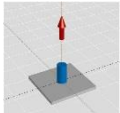
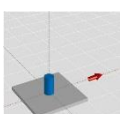
Anchor size		M8	M10	M12	M16	M20	M24	
Embedment depth $h_{ef} = h_{ef,min}$ [mm]		64	80	96	128	160	192	
Base material thickness $h = h_{min}$ [mm]		100	110	126	164	204	248	
	Tensile N_{rec}: single anchor, no edge effects							
	HIT-V(-F) 5.8							
	HIT-V(-F) 8.8							
	HIT-V-R	[kN]	7,6	11,0	15,8	25,5	37,9	51,7
	HIT-V-HCR							
	Shear V_{rec}: single anchor, no edge effects, without lever arm							
	HIT-V(-F) 5.8	[kN]	5,1	8,6	12,0	22,3	34,9	50,3
	HIT-V(-F) 8.8	[kN]	8,6	13,1	19,4	36,0	56,0	80,6
	HIT-V-R	[kN]	5,9	9,1	13,7	25,2	39,4	56,8
	HIT-V-HCR	[kN]	8,6	13,1	19,4	36,0	56,0	50,6

Recommended loads: non-cracked concrete C 20/25 - minimum embedment depth

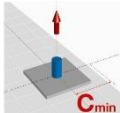
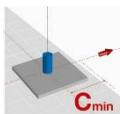
Anchor size		M8	M10	M12	M16	M20	M24	
Embedment depth $h_{ef} = h_{ef,min}$ [mm]		64	80	96	128	160	192	
Base material thickness $h = h_{min}$ [mm]		100	110	126	164	204	248	
Edge distance $c = c_{min}$ [mm]		40	50	60	80	100	120	
	Tensile N_{rec}: single anchor, min. edge distance ($c = c_{min}$)							
	HIT-V(-F) 5.8	[kN]	4,5	6,4	9,2	15,2	22,8	31,1
	HIT-V(-F) 8.8							
	HIT-V-R							
	HIT-V-HCR							
	Shear V_{rec}: single anchor, min. edge distance ($c = c_{min}$), without lever arm							
	HIT-V(-F) 5.8	[kN]	2,6	3,7	5,1	8,3	12,1	16,4
	HIT-V(-F) 8.8							
	HIT-V-R							
	HIT-V-HCR							

Recommended loads: non-cracked concrete C 20/25 - minimum embedment depth (load values are valid for single anchor)

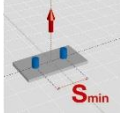
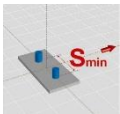
Anchor size		M8	M10	M12	M16	M20	M24	
Embedment depth $h_{ef} = h_{ef,min}$ [mm]		64	80	96	128	160	192	
Base material thickness $h = h_{min}$ [mm]		100	110	126	164	204	248	
Spacing $s = s_{min}$ [mm]		40	50	60	80	100	120	
	Tensile N_{rec}: double anchor, no edge effects, min. spacing ($s = s_{min}$)							
	HIT-V(-F) 5.8	[kN]	5,0	7,1	10,0	16,1	23,6	32,0
	HIT-V(-F) 8.8							
	HIT-V-R							
	HIT-V-HCR							
	Shear V_{rec}: double anchor, no edge effects, min. spacing ($s = s_{min}$), without lever arm							
	HIT-V(-F) 5.8	[kN]	5,1	8,6	12,0	22,3	34,9	50,3
	HIT-V(-F) 8.8	[kN]	8,6	13,1	19,1	30,9	45,8	62,5
	HIT-V-R	[kN]	5,9	9,1	13,7	25,2	39,4	56,8
	HIT-V-HCR	[kN]	8,6	13,1	19,1	30,9	45,8	50,6

For the recommended loads an overall partial safety factor for action $\gamma = 1,4$ is considered. The partial safety factors for action depend on the type of loading and shall be taken from national regulations. According ETAG 001, annex C, the partial safety factor is $\gamma_G = 1,35$ for permanent actions and $\gamma_Q = 1,5$ for variable actions.

Recommended loads: non-cracked concrete C 20/25 - typical embedment depth

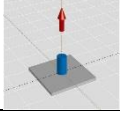
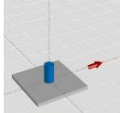
Anchor size		M8	M10	M12	M16	M20	M24	
Embedment depth $h_{ef} = h_{ef,typ}$ [mm]		80	90	110	130	170	210	
Base material thickness $h = h_{min}$ [mm]		110	120	140	166	214	266	
	Tensile N_{rec}: single anchor, no edge effects							
	HIT-V(-F) 5.8	[kN]	8,6	12,4	18,1	25,9	40,3	56,6
	HIT-V(-F) 8.8	[kN]	9,6	12,4	18,1	25,9	40,3	56,6
	HIT-V-R							
	HIT-V-HCR							
	Shear V_{rec}: single anchor, no edge effects, without lever arm							
	HIT-V(-F) 5.8	[kN]	5,1	8,6	12,0	22,3	34,9	50,3
	HIT-V(-F) 8.8	[kN]	8,6	13,1	19,4	36,0	56,0	80,6
	HIT-V-R	[kN]	5,9	9,1	13,7	25,2	39,4	56,8
	HIT-V-HCR	[kN]	8,6	13,1	19,4	36,0	56,0	50,6

Recommended loads: non-cracked concrete C 20/25 - typical embedment depth

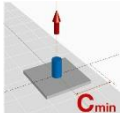
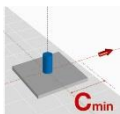
Anchor size		M8	M10	M12	M16	M20	M24	
Embedment depth $h_{ef} = h_{ef,typ}$ [mm]		80	90	110	130	170	210	
Base material thickness $h = h_{min}$ [mm]		110	120	140	166	214	266	
Edge distance $c = c_{min}$ [mm]		40	50	60	80	100	120	
	Tensile N_{rec}: single anchor, min. edge distance ($c = c_{min}$)							
	HIT-V(-F) 5.8							
	HIT-V(-F) 8.8	[kN]	5,5	7,2	10,5	15,4	24,2	34,3
	HIT-V-R							
	HIT-V-HCR							
	Shear V_{rec}: single anchor, min. edge distance ($c = c_{min}$), without lever arm							
	HIT-V(-F) 5.8							
	HIT-V(-F) 8.8	[kN]	2,6	3,8	5,2	8,3	12,3	16,9
	HIT-V-R							
	HIT-V-HCR							

**Recommended loads: non-cracked concrete C 20/25 - typical embedment depth
(load values are valid for single anchor)**

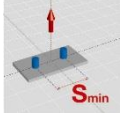
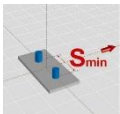
Anchor size		M8	M10	M12	M16	M20	M24	
Embedment depth $h_{ef} = h_{ef,typ}$ [mm]		80	90	110	130	170	210	
Base material thickness $h = h_{min}$ [mm]		110	120	140	166	214	266	
Spacing s [mm]		40	50	60	80	100	120	
	Tensile N_{rec}: double anchor, no edge effects, min. spacing ($s = s_{min}$)							
	HIT-V(-F) 5.8							
	HIT-V(-F) 8.8	[kN]	6,4	8,1	11,6	16,4	25,3	35,5
	HIT-V-R							
	HIT-V-HCR							
	Shear V_{rec}: double anchor, no edge effects, min. spacing ($s = s_{min}$), without lever arm							
	HIT-V(-F) 5.8	[kN]	5,1	8,6	12,0	22,3	34,9	50,3
	HIT-V(-F) 8.8	[kN]	8,6	13,1	19,4	31,2	48,1	67,3
	HIT-V-R	[kN]	5,9	9,1	13,7	25,2	39,4	56,8
	HIT-V-HCR	[kN]	8,6	13,1	19,4	31,2	48,1	50,6

For the recommended loads an overall partial safety factor for action $\gamma = 1,4$ is considered. The partial safety factors for action depend on the type of loading and shall be taken from national regulations. According ETAG 001, annex C, the partial safety factor is $\gamma_G = 1,35$ for permanent actions and $\gamma_Q = 1,5$ for variable actions.

Recommended loads: non-cracked concrete C 20/25 - embedment depth = 12 d^{a)}

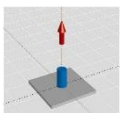
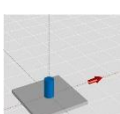
Anchor size		M8	M10	M12	M16	M20	M24	
Embedment depth $h_{ef} = 12 d^{a)}$ [mm]		96	120	144	192	240	288	
Base material thickness $h = h_{min}$ [mm]		126	150	174	228	284	344	
	Tensile N_{rec}: single anchor, no edge effects							
	HIT-V(-F) 5.8	[kN]	8,6	13,8	20,0	37,6	56,9	77,6
	HIT-V(-F) 8.8	[kN]	11,5	16,4	23,7	38,3	56,9	77,6
	HIT-V-R	[kN]	9,9	15,6	22,6	38,3	56,9	77,6
	HIT-V-HCR	[kN]	11,5	16,4	23,7	38,3	56,9	77,6
	Shear V_{rec}: single anchor, no edge effects, without lever arm							
	HIT-V(-F) 5.8	[kN]	5,1	8,6	12,0	22,3	34,9	50,3
	HIT-V(-F) 8.8	[kN]	8,6	13,1	19,4	36,0	56,0	80,6
	HIT-V-R	[kN]	5,9	9,1	13,7	25,2	39,4	56,8
	HIT-V-HCR	[kN]	8,6	13,1	19,4	36,0	56,0	50,6

a) d = element diameter

Recommended loads: non-cracked concrete C 20/25 - embedment depth = 12 d^{a)}

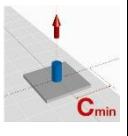
Anchor size	M8	M10	M12	M16	M20	M24	
Embedment depth $h_{ef} = 12 d^{a)}$ [mm]	96	120	144	192	240	288	
Base material thickness $h = h_{min}$ [mm]	126	150	174	228	284	344	
Edge distance $c = c_{min}$ [mm]	40	50	60	80	100	120	
 Tensile N_{rec}: single anchor, min. edge distance ($c = c_{min}$) HIT-V(-F) 5.8 HIT-V(-F) 8.8 [kN] HIT-V-R HIT-V-HCR	6,6	9,6	13,8	22,8	34,2	47,3	
	Shear V_{rec}: single anchor, min. edge distance ($c = c_{min}$), without lever arm						
	HIT-V(-F) 5.8	2,8	4,1	5,6	9,2	13,5	18,5
	HIT-V(-F) 8.8 [kN]						
	HIT-V-R HIT-V-HCR						

a) d = element diameter



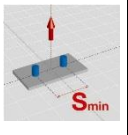

Recommended loads: non-cracked concrete C 20/25 - embedment depth = 12 d^{a)} (load values are valid for single anchor)

Anchor size	M8	M10	M12	M16	M20	M24	
Embedment depth $h_{ef} = 12 d^{a)}$ [mm]	96	120	144	192	240	288	
Base material thickness $h = h_{min}$ [mm]	126	150	174	228	284	344	
Spacing $s = s_{min}$ [mm]	40	50	60	80	100	120	
 Tensile N_{rec}: double anchor, no edge effects, min. spacing ($s = s_{min}$) HIT-V(-F) 5.8 HIT-V(-F) 8.8 [kN] HIT-V-R HIT-V-HCR	7,7	11,1	15,7	25,3	37,2	50,6	
	Shear V_{rec}: double anchor, no edge effects, min. spacing ($s = s_{min}$), without lever arm						
	HIT-V(-F) 5.8 [kN]	5,1	8,6	12,0	22,3	34,9	50,3
	HIT-V(-F) 8.8 [kN]	8,6	13,1	19,4	36,0	56,0	80,6
	HIT-V-R [kN]	5,9	9,1	13,7	25,2	39,4	56,8
HIT-V-HCR [kN]	8,6	13,1	19,4	36,0	56,0	80,6	

For the recommended loads an overall partial safety factor for action $\gamma = 1,4$ is considered. The partial safety factors for action depend on the type of loading and shall be taken from national regulations. According ETAG 001, annex C, the partial safety factor is $\gamma_G = 1,35$ for permanent actions and $\gamma_Q = 1,5$ for variable actions.

a) d = element diameter

Hilti HIT-ICE mortar with HIT-V / HAS rod

Injection mortar system	Benefits
 <p>Hilti HIT-ICE 296 ml cartridge</p>	<ul style="list-style-type: none"> - suitable for non-cracked concrete C 20/25 to C 50/60 - high loading capacity - suitable for dry and water saturated concrete - high corrosion resistant - odourless resin - low installation temperature (range -23 °C to +32 °C)
 <p>Statik mixer</p>	
 <p>HAS rod</p>	
 <p>HAS-E rod</p>	
 <p>HIT-V rod</p>	



Concrete

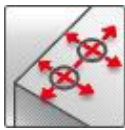

Small edge distance and spacing



Corrosion resistance



High corrosion resistance



PROFIS Anchor design software

Basic loading data (for a single anchor)

All data in this section applies to

- Correct setting (See setting instruction)
- No edge distance and spacing influence
- Steel failure
- Base material thickness, as specified in the table
- One typical embedment depth, as specified in the table
- One anchor material, as specified in the tables
- Concrete C 20/25, $f_{ck,cube} = 25 \text{ N/mm}^2$
- Installation temperature range -18°C to +32°C

For details see Simplified design method

Embedment depth ^{a)} and base material thickness for the basic loading data. Mean ultimate resistance, characteristic resistance, design resistance, recommended loads.

Anchor size	M8	M10	M12	M16	M20	M24
Embedment depth [mm]	80	90	110	125	170	210
Base material thickness [mm]	110	120	140	165	220	270

a) The allowed range of embedment depth is shown in the setting details. The corresponding load values can be calculated according to the simplified design method.

Mean ultimate resistance: concrete C 20/25 – $f_{ck,cube} = 25 \text{ N/mm}^2$, anchor HIT-V 5.8

			Hilti technical data					
Anchor size			M8	M10	M12	M16	M20	M24
Tensile $N_{Ru,m}$	HIT-V 5.8	[kN]	18,9	30,5	44,1	59,9	101,9	127,1
Shear $V_{Ru,m}$	HIT-V 5.8	[kN]	9,5	15,8	22,1	41,0	64,1	92,4

Characteristic resistance: concrete C 20/25 – $f_{ck,cube} = 25 \text{ N/mm}^2$, anchor HIT-V 5.8

			Hilti technical data					
Anchor size			M8	M10	M12	M16	M20	M24
Tensile N_{Rk}	HIT-V 5.8	[kN]	17,6	23,5	35,3	44,9	76,4	95,3
Shear V_{Rk}	HIT-V 5.8	[kN]	9,0	15,0	21,0	39,0	61,0	88,0

Design resistance: concrete C 20/25 – $f_{ck,cube} = 25 \text{ N/mm}^2$, anchor HIT-V 5.8

			Hilti technical data					
Anchor size			M8	M10	M12	M16	M20	M24
Tensile N_{Rd}	HIT-V 5.8	[kN]	8,4	11,2	16,8	21,4	36,4	45,4
Shear V_{Rd}	HIT-V 5.8	[kN]	7,2	12,0	16,8	31,2	48,8	70,4

Recommended loads ^{a)}: concrete C 20/25 – $f_{ck,cube} = 25 \text{ N/mm}^2$, anchor HIT-V 5.8

			Hilti technical data					
Anchor size			M8	M10	M12	M16	M20	M24
Tensile N_{rec}	HIT-V 5.8	[kN]	6,0	8,0	12,0	15,3	26,0	32,4
Shear V_{rec}	HIT-V 5.8	[kN]	5,1	8,6	12,0	22,3	34,9	50,3

a) With overall partial safety factor for action $\gamma = 1,4$. The partial safety factors for action depend on the type of loading and shall be taken from national regulations.

Service temperature range

Hilti HIT-ICE injection mortar may be applied in the temperature range given below. An elevated base material temperature may lead to a reduction of the design bond resistance.

Temperature range	Base material temperature	Maximum long term base material temperature	Maximum short term base material temperature
Temperature range I	-40 °C to +70 °C	+43 °C	+70 °C

Max short term base material temperature

Short-term elevated base material temperatures are those that occur over brief intervals, e.g. as a result of diurnal cycling.

Max long term base material temperature

Long-term elevated base material temperatures are roughly constant over significant periods of time.

Materials

Mechanical properties of HIT-V / HAS

Anchor size			Hilti technical data					
			M8	M10	M12	M16	M20	M24
Nominal tensile strength f_{uk}	HIT-V/HAS 5.8	[N/mm ²]	500	500	500	500	500	500
	HIT-V 8.8	[N/mm ²]	800	800	800	800	800	800
	HIT-V/HAS -R	[N/mm ²]	700	700	700	700	700	700
	HIT-V/HAS -HCR	[N/mm ²]	800	800	800	800	800	700
Yield strength f_{yk}	HIT-V/HAS 5.8	[N/mm ²]	400	400	400	400	400	400
	HIT-V 8.8	[N/mm ²]	640	640	640	640	640	640
	HIT-V/HAS -R	[N/mm ²]	450	450	450	450	450	450
	HIT-V/HAS -HCR	[N/mm ²]	600	600	600	600	600	400
Stressed cross-section A_s	HAS	[mm ²]	32,8	52,3	76,2	144	225	324
	HIT-V	[mm ²]	36,6	58,0	84,3	157	245	353
Moment of resistance W	HAS	[mm ³]	27,0	54,1	93,8	244	474	809
	HIT-V	[mm ³]	31,2	62,3	109	277	541	935

Material quality

Part	Material
Threaded rod HIT-V(F), HAS 5.8	Strength class 5.8, $A_5 > 8\%$ ductile steel galvanized $\geq 5 \mu\text{m}$, (F) hot dipped galvanized $\geq 45 \mu\text{m}$,
Threaded rod HIT-V(F) 8.8	Strength class 8.8, $A_5 > 8\%$ ductile steel galvanized $\geq 5 \mu\text{m}$, (F) hot dipped galvanized $\geq 45 \mu\text{m}$,
Threaded rod HIT-V-R, HAS-R	Stainless steel grade A4, $A_5 > 8\%$ ductile strength class 70, 1.4401; 1.4404; 1.4578; 1.4571; 1.4439; 1.4362
Threaded rod HIT-V-HCR, HAS-HCR	High corrosion resistant steel, 1.4529; 1.4565 strength \leq M20: $R_m = 800 \text{ N/mm}^2$, $R_{p0.2} = 640 \text{ N/mm}^2$, $A_5 > 8\%$ ductile M24: $R_m = 700 \text{ N/mm}^2$, $R_{p0.2} = 400 \text{ N/mm}^2$, $A_5 > 8\%$ ductile
Washer ISO 7089	Steel galvanized, hot dipped galvanized,
	Stainless steel, 1.4401; 1.4404; 1.4578; 1.4571; 1.4439; 1.4362
	High corrosion resistant steel, 1.4529; 1.4565
Nut EN ISO 4032	Strength class 8, steel galvanized $\geq 5 \mu\text{m}$, hot dipped galvanized $\geq 45 \mu\text{m}$,
	Strength class 70, stainless steel grade A4, 1.4401; 1.4404; 1.4578; 1.4571; 1.4439; 1.4362
	Strength class 70, high corrosion resistant steel, 1.4529; 1.4565

Anchor dimensions

Anchor size	M8	M10	M12	M16	M20	M24
Anchor rod HAS, HAS-E, HAS-R, HAS-ER HAS-HCR	M8x80	M10x90	M12x110	M16x125	M20x170	M24x210
Anchor embedment depth [mm]	80	90	110	125	170	210
Anchor rod HIT-V, HIT-V-R, HIT-V-HCR	Anchor rods HIT-V (-R / -HCR) are available in variable length					

Setting

installation equipment

Anchor size	M8	M10	M12	M16	M20	M24
Rotary hammer	TE 2 – TE 16				TE 40 – TE 50	
Other tools	compressed air gun or blow out pump, set of cleaning brushes, dispenser					

Setting instruction

Dry and water-saturated concrete, hammer drilling

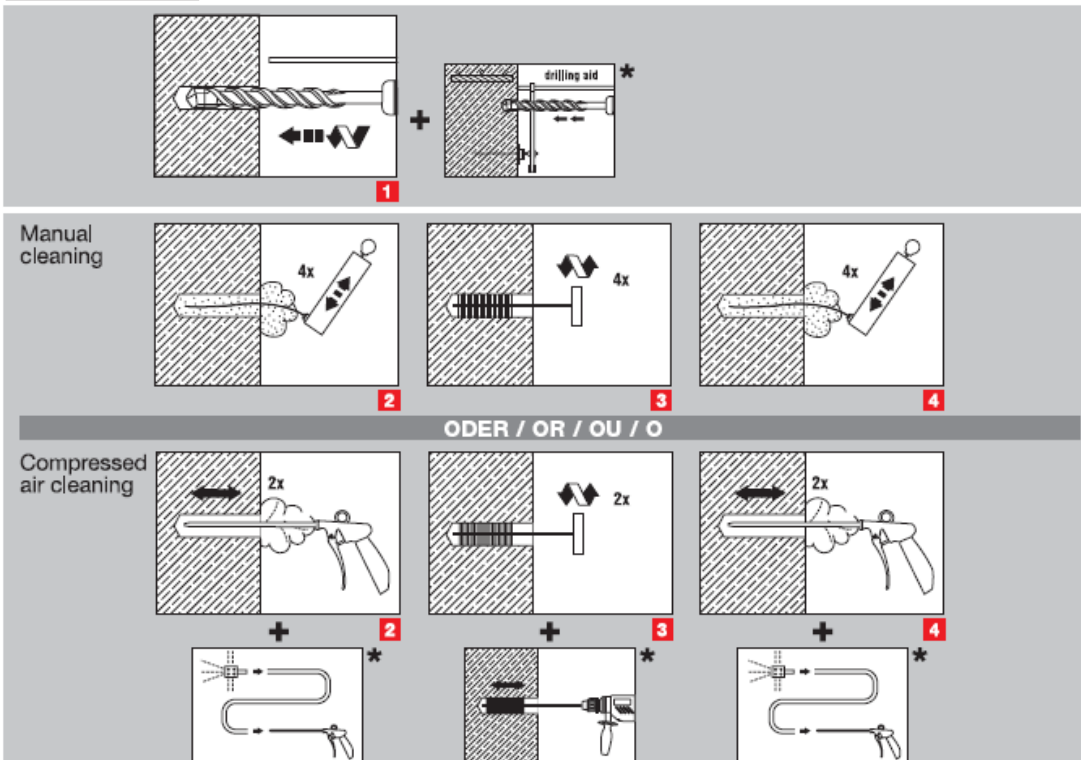
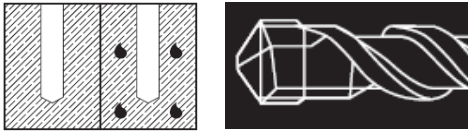

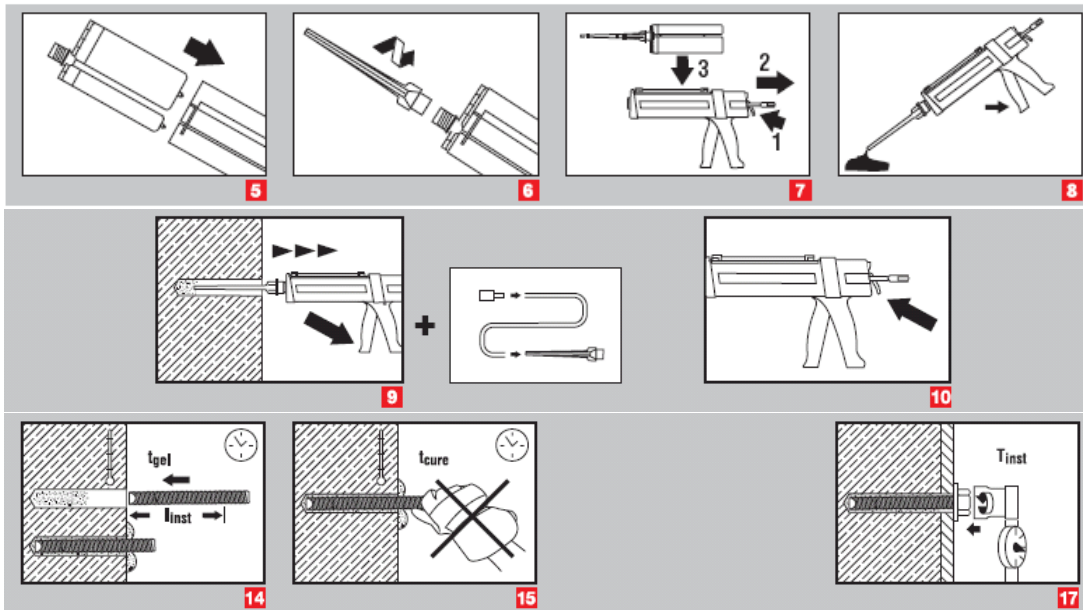

a) Note: Manual cleaning for element sizes $d \leq 16\text{mm}$ and embedment depth $h_{ef} \leq 10 d$ only!
Brush bore hole with required steel brush HIT-RB
For detailed information on installation see instruction for use given with the package of the product.

Curing time for general conditions

Temperature of the base material	Hilti technical data	
	Curing time before anchor can be fully loaded t_{cure}	Working time in which anchor can be inserted and adjusted t_{gel}
32 °C	35 min	1 min
21 °C	45 min	2,5 min
16 °C	1 h	5 min
4 °C	1 ½ h	15 min
- 7 °C	6 h	1 h
- 18 °C	24 h	1,5 h
- 23 °C	36 h	1,5 h

Setting details

			Hilti technical data					
Anchor size			M8	M10	M12	M16	M20	M24
Nominal diameter of drill bit	d_0	[mm]	10	12	14	18	24	28
Effective anchorage and drill hole depth	h_{ef}	[mm]	80	90	110	125	170	210
Minimum base material thickness ^{b)}	h_{min}	[mm]	$h_{ef} + 30 \text{ mm}$ $\geq 100 \text{ mm}$			$h_{ef} + 2 d_0$		
Diameter of clearance hole in the fixture	d_f	[mm]	9	12	14	18	22	26
Minimum spacing	s_{min}	[mm]	40	50	60	80	100	120
Minimum edge distance	c_{min}	[mm]	40	50	60	80	100	120
Critical spacing for splitting failure	$s_{cr,sp}$		$2 c_{cr,sp}$					
Critical edge distance for splitting failure ^{c)}	$c_{cr,sp}$	[mm]	$1,0 \cdot h_{ef}$ for $h / h_{ef} \geq 2,0$					
			$4,6 h_{ef} - 1,8 h$ for $2,0 > h / h_{ef} > 1,3$					
			$2,26 h_{ef}$ for $h / h_{ef} \leq 1,3$					
Critical spacing for concrete cone failure	$s_{cr,N}$		$2 c_{cr,N}$					
Critical edge distance for concrete cone failure ^{b)}	$c_{cr,N}$		$1.5 h_{ef}$					
Torque moment ^{c)}	T_{inst}	[Nm]	10	20	40	80	150	200

For spacing (edge distance) smaller than critical spacing (critical edge distance) the design loads have to be reduced.

- h : base material thickness ($h \geq h_{min}$)
- The critical edge distance for concrete cone failure depends on the embedment depth h_{ef} and the design bond resistance. The simplified formula given in this table is on the safe side.
- This is the maximum recommended torque moment to avoid splitting failure during installation for anchors with minimum spacing and/or edge distance.

Simplified design method

Simplified version of the design method according ETAG 001, TR 029. Design resistance according data given by Hilti.

- Influence of concrete strength
- Influence of edge distance
- Influence of spacing
- Valid for a group of two anchors. (The method may also be applied for anchor groups with more than two anchors or more than one edge distance. The influencing factors must then be considered for each edge distance and spacing. The calculated design loads are then on the save side: They will be lower than the exact values according ETAG 001, TR 029. To avoid this, it is recommended to use the anchor design software PROFIS anchor)

The design method is based on the following simplification:

- No different loads are acting on individual anchors (no eccentricity)

The values are valid for one anchor.

For more complex fastening applications please use the anchor design software PROFIS Anchor.

Tension loading

The design tensile resistance is the lower value of

- Steel resistance: $N_{Rd,s}$
- Combined pull-out and concrete cone resistance: $N_{Rd,p} = N_{Rd,p}^0 \cdot f_{B,p} \cdot f_{1,N} \cdot f_{2,N} \cdot f_{3,N} \cdot f_{h,p} \cdot f_{re,N}$
- Concrete cone resistance: $N_{Rd,c} = N_{Rd,c}^0 \cdot f_B \cdot f_{1,N} \cdot f_{2,N} \cdot f_{3,N} \cdot f_{h,N} \cdot f_{re,N}$
- Concrete splitting resistance (only non-cracked concrete): $N_{Rd,sp} = N_{Rd,c}^0 \cdot f_B \cdot f_{1,sp} \cdot f_{2,sp} \cdot f_{3,sp} \cdot f_{h,N} \cdot f_{re,N}$

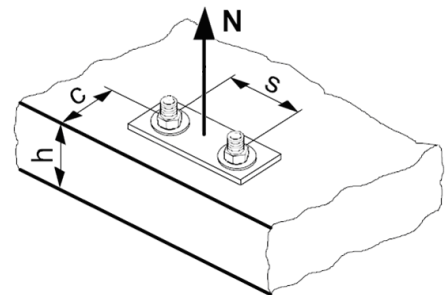

Basic design tensile resistance

Design steel resistance $N_{Rd,s}$

		Hilti technical data					
Anchor size		M8	M10	M12	M16	M20	M24
$N_{Rd,s}$	HAS 5.8 [kN]	11,1	17,6	25,4	48,1	74,8	106,8
	HIT-V 5.8 [kN]	12,0	19,3	28,0	52,7	82,0	118,0
	HIT-V 8.8 [kN]	19,3	30,7	44,7	84,0	130,7	188,0
	HAS (-E)-R [kN]	12,4	19,8	28,6	54,1	84,1	120,2
	HIT-V-R [kN]	13,9	21,9	31,6	58,8	92,0	132,1
	HAS (-E)-HCR [kN]	17,7	28,2	40,6	76,9	119,6	106,8
	HIT-V-HCR [kN]	19,3	30,7	44,7	84,0	130,7	117,6

Design combined pull-out and concrete cone resistance

$$N_{Rd,p} = N_{Rd,p}^0 \cdot f_{B,p} \cdot f_{1,N} \cdot f_{2,N} \cdot f_{3,N} \cdot f_{h,p} \cdot f_{re,N}$$

		Hilti technical data					
Anchor size		M8	M10	M12	M16	M20	M24
Typical embedment depth $h_{ef,typ}$ [mm]		80	90	110	125	170	210
$N_{Rd,p}^0$	Temperature range I [kN]	8,4	11,2	16,8	21,4	36,4	45,4

Design concrete cone resistance $N_{Rd,c} = N_{Rd,c}^0 \cdot f_B \cdot f_{1,N} \cdot f_{2,N} \cdot f_{3,N} \cdot f_{h,N} \cdot f_{re,N}$

Design splitting resistance $N_{Rd,sp} = N_{Rd,c}^0 \cdot f_B \cdot f_{1,sp} \cdot f_{2,sp} \cdot f_{3,sp} \cdot f_{h,N} \cdot f_{re,N}$

		Hilti technical data					
Anchor size		M8	M10	M12	M16	M20	M24
$N_{Rd,c}^0$	[kN]	17,2	20,5	27,7	33,6	53,3	73,2

Influencing factors

Influence of concrete strength on combined pull-out and concrete cone resistance

Concrete strength designation (ENV 206)	C 20/25	C 25/30	C 30/37	C 35/45	C 40/50	C 45/55	C 50/60
$f_{B,p} = (f_{ck,cube}/25N/mm^2)^{0,1}$ a)	1	1,02	1,04	1,06	1,07	1,08	1,09

a) $f_{ck,cube}$ = concrete compressive strength, measured on cubes with 150 mm side length

Influence of embedment depth on combined pull-out and concrete cone resistance

$f_{h,p} = 1$

Influence of concrete strength on concrete cone resistance

Concrete strength designation (ENV 206)	C 20/25	C 25/30	C 30/37	C 35/45	C 40/50	C 45/55	C 50/60
$f_B = (f_{ck,cube}/25N/mm^2)^{1/2}$ a)	1	1,1	1,22	1,34	1,41	1,48	1,55

a) $f_{ck,cube}$ = concrete compressive strength, measured on cubes with 150 mm side length

Influence of embedment depth on concrete cone resistance

$f_{h,N} = 1$

Influence of edge distance a)

$c/c_{cr,N}$	0,1	0,2	0,3	0,4	0,5	0,6	0,7	0,8	0,9	1
$c/c_{cr,sp}$										
$f_{1,N} = 0,7 + 0,3 \cdot c/c_{cr,N}$	0,73	0,76	0,79	0,82	0,85	0,88	0,91	0,94	0,97	1
$f_{1,sp} = 0,7 + 0,3 \cdot c/c_{cr,sp}$										
$f_{2,N} = 0,5 \cdot (1 + c/c_{cr,N})$	0,55	0,60	0,65	0,70	0,75	0,80	0,85	0,90	0,95	1
$f_{2,sp} = 0,5 \cdot (1 + c/c_{cr,sp})$										

a) The edge distance shall not be smaller than the minimum edge distance c_{min} given in the table with the setting details. These influencing factors must be considered for every edge distance smaller than the critical edge distance.

Influence of anchor spacing a)

$s/s_{cr,N}$	0,1	0,2	0,3	0,4	0,5	0,6	0,7	0,8	0,9	1
$s/s_{cr,sp}$										
$f_{3,N} = 0,5 \cdot (1 + s/s_{cr,N})$	0,55	0,60	0,65	0,70	0,75	0,80	0,85	0,90	0,95	1
$f_{3,sp} = 0,5 \cdot (1 + s/s_{cr,sp})$										

a) The anchor spacing shall not be smaller than the minimum anchor spacing s_{min} given in the table with the setting details. This influencing factor must be considered for every anchor spacing.

Influence of reinforcement

h_{ef} [mm]	80	90	≥ 100
$f_{re,N} = 0,5 + h_{ef}/200\text{mm} \leq 1$	0,9 ^{a)}	0,95 ^{a)}	1

a) This factor applies only for dense reinforcement. If in the area of anchorage there is reinforcement with a spacing ≥ 150 mm (any diameter) or with a diameter ≤ 10 mm and a spacing ≥ 100 mm, then a factor $f_{re,N} = 1$ may be applied.

Shear loading

The design shear resistance is the lower value of

- Steel resistance: $V_{Rd,s}$
- Concrete pryout resistance: $V_{Rd,cp} = k \cdot \text{lower value of } N_{Rd,p} \text{ and } N_{Rd,c}$
- Concrete edge resistance: $V_{Rd,c} = V_{Rd,c}^0 \cdot f_B \cdot f_{\beta} \cdot f_h \cdot f_4 \cdot f_{hef} \cdot f_c$

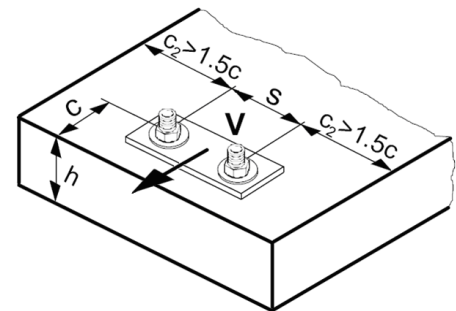

Basic design shear resistance

Design steel resistance $V_{Rd,s}$

Anchor size		Hilti technical data					
		M8	M10	M12	M16	M20	M24
$V_{Rd,s}$	HAS 5.8 [kN]	6,6	10,6	15,2	28,8	44,9	64,1
	HIT-V 5.8 [kN]	7,2	12,0	16,8	31,2	48,8	70,4
	HIT-V 8.8 [kN]	12,0	18,4	27,2	50,4	78,4	112,8
	HAS (-E)-R [kN]	7,5	11,9	17,1	32,4	50,5	72,1
	HIT-V-R [kN]	8,3	12,8	19,2	35,3	55,1	79,5
	HAS (-E)-HCR [kN]	10,6	16,9	24,4	46,1	71,8	64,1
	HIT-V-HCR [kN]	12,0	18,4	27,2	50,4	78,4	70,9

Design concrete pryout resistance $V_{Rd,cp} = \text{lower value}^a)$ of $k \cdot N_{Rd,p}$ and $k \cdot N_{Rd,c}$

$$k = 2$$

- a) $N_{Rd,p}$: Design combined pull-out and concrete cone resistance
 $N_{Rd,c}$: Design concrete cone resistance

Design concrete edge resistance $V_{Rd,c} = V_{Rd,c}^0 \cdot f_B \cdot f_{\beta} \cdot f_h \cdot f_4 \cdot f_{hef} \cdot f_c$

Anchor size		M8	M10	M12	M16	M20	M24
Non-cracked concrete							
$V_{Rd,c}^0$	[kN]	5,9	8,6	11,6	18,7	27,0	36,6

Influencing factors

Influence of concrete strength

Concrete strength designation (ENV 206)	C 20/25	C 25/30	C 30/37	C 35/45	C 40/50	C 45/55	C 50/60
$f_B = (f_{ck,cube}/25N/mm^2)^{1/2}$ a)	1	1,1	1,22	1,34	1,41	1,48	1,55

a) $f_{ck,cube}$ = concrete compressive strength, measured on cubes with 150 mm side length

Influence of angle between load applied and the direction perpendicular to the free edge

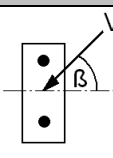
Angle β	0°	10°	20°	30°	40°	50°	60°	70°	80°	≥ 90°
$f_\beta = \sqrt{\frac{1}{(\cos \alpha_V)^2 + \left(\frac{\sin \alpha_V}{2,5}\right)^2}}$ 	1	1,01	1,05	1,13	1,24	1,40	1,64	1,97	2,32	2,50

Influence of base material thickness

h/c	0,15	0,3	0,45	0,6	0,75	0,9	1,05	1,2	1,35	≥ 1,5
$f_h = \{h/(1,5 \cdot c)\}^{1/2} \leq 1$	0,32	0,45	0,55	0,63	0,71	0,77	0,84	0,89	0,95	1,00

Influence of anchor spacing and edge distance ^{a)} for concrete edge resistance: f_4

$$f_4 = (c/h_{ef})^{1,5} \cdot (1 + s / [3 \cdot c]) \cdot 0,5$$

c/h _{ef}	Single anchor	Group of two anchors s/h _{ef}														
		0,75	1,50	2,25	3,00	3,75	4,50	5,25	6,00	6,75	7,50	8,25	9,00	9,75	10,50	11,25
0,50	0,35	0,27	0,35	0,35	0,35	0,35	0,35	0,35	0,35	0,35	0,35	0,35	0,35	0,35	0,35	0,35
0,75	0,65	0,43	0,54	0,65	0,65	0,65	0,65	0,65	0,65	0,65	0,65	0,65	0,65	0,65	0,65	0,65
1,00	1,00	0,63	0,75	0,88	1,00	1,00	1,00	1,00	1,00	1,00	1,00	1,00	1,00	1,00	1,00	1,00
1,25	1,40	0,84	0,98	1,12	1,26	1,40	1,40	1,40	1,40	1,40	1,40	1,40	1,40	1,40	1,40	1,40
1,50	1,84	1,07	1,22	1,38	1,53	1,68	1,84	1,84	1,84	1,84	1,84	1,84	1,84	1,84	1,84	1,84
1,75	2,32	1,32	1,49	1,65	1,82	1,98	2,15	2,32	2,32	2,32	2,32	2,32	2,32	2,32	2,32	2,32
2,00	2,83	1,59	1,77	1,94	2,12	2,30	2,47	2,65	2,83	2,83	2,83	2,83	2,83	2,83	2,83	2,83
2,25	3,38	1,88	2,06	2,25	2,44	2,63	2,81	3,00	3,19	3,38	3,38	3,38	3,38	3,38	3,38	3,38
2,50	3,95	2,17	2,37	2,57	2,77	2,96	3,16	3,36	3,56	3,76	3,95	3,95	3,95	3,95	3,95	3,95
2,75	4,56	2,49	2,69	2,90	3,11	3,32	3,52	3,73	3,94	4,15	4,35	4,56	4,56	4,56	4,56	4,56
3,00	5,20	2,81	3,03	3,25	3,46	3,68	3,90	4,11	4,33	4,55	4,76	4,98	5,20	5,20	5,20	5,20
3,25	5,86	3,15	3,38	3,61	3,83	4,06	4,28	4,51	4,73	4,96	5,18	5,41	5,63	5,86	5,86	5,86
3,50	6,55	3,51	3,74	3,98	4,21	4,44	4,68	4,91	5,14	5,38	5,61	5,85	6,08	6,31	6,55	6,55
3,75	7,26	3,87	4,12	4,36	4,60	4,84	5,08	5,33	5,57	5,81	6,05	6,29	6,54	6,78	7,02	7,26
4,00	8,00	4,25	4,50	4,75	5,00	5,25	5,50	5,75	6,00	6,25	6,50	6,75	7,00	7,25	7,50	7,75
4,25	8,76	4,64	4,90	5,15	5,41	5,67	5,93	6,18	6,44	6,70	6,96	7,22	7,47	7,73	7,99	8,25
4,50	9,55	5,04	5,30	5,57	5,83	6,10	6,36	6,63	6,89	7,16	7,42	7,69	7,95	8,22	8,49	8,75
4,75	10,35	5,45	5,72	5,99	6,27	6,54	6,81	7,08	7,36	7,63	7,90	8,17	8,45	8,72	8,99	9,26
5,00	11,18	5,87	6,15	6,43	6,71	6,99	7,27	7,55	7,83	8,11	8,39	8,66	8,94	9,22	9,50	9,78
5,25	12,03	6,30	6,59	6,87	7,16	7,45	7,73	8,02	8,31	8,59	8,88	9,17	9,45	9,74	10,02	10,31
5,50	12,90	6,74	7,04	7,33	7,62	7,92	8,21	8,50	8,79	9,09	9,38	9,67	9,97	10,26	10,55	10,85

a) The anchor spacing and the edge distance shall not be smaller than the minimum anchor spacing s_{min} and the minimum edge distance c_{min} .

Influence of embedment depth

Anchor size	M8	M10	M12	M16	M20	M24
$f_{hef} = 0,05 \cdot (h_{ef} / d)^{1,68}$	2,39	2	2,07	1,58	1,82	1,91

Influence of edge distance ^{a)}

c/d	4	6	8	10	15	20	30	40
$f_c = (d/c)^{0,19}$	0,77	0,71	0,67	0,65	0,60	0,57	0,52	0,50

a) The edge distance shall not be smaller than the minimum edge distance c_{min} .

Combined tension and shear loading

For combined tension and shear loading see section "Anchor Design".

Precalculated values

Recommended loads can be calculated by dividing the design resistance by an overall partial safety factor for action $\gamma = 1,4$. The partial safety factors for action depend on the type of loading and shall be taken from national regulations.

Design resistance: concrete C 20/25 – $f_{ck,cube} = 25 \text{ N/mm}^2$

		Hilti technical data						
Anchor size		M8	M10	M12	M16	M20	M24	
Embedment depth	$h_{ef,typ} = [\text{mm}]$	80	90	110	125	170	210	
Base material thickness	$h_{min} = [\text{mm}]$	110	120	140	161	218	266	
Tensile N_{Rd}: single anchor, no edge effects								
	HIT-V 5.8 HIT-V 8.8 HIT-V-R HIT-V-HCR	[kN]	8,4	11,2	16,8	21,4	36,4	45,4
Shear V_{Rd}: single anchor, no edge effects, without lever arm								
	HIT-V 5.8 HIT-V 8.8 HIT-V-R HIT-V-HCR	[kN]	7,2	12,0	16,8	31,2	48,8	70,4
		[kN]	12,0	18,4	27,2	50,4	78,4	112,8
		[kN]	8,3	12,8	19,2	35,3	55,1	79,5
		[kN]	12,0	18,4	27,2	50,4	78,4	70,9



Design resistance: concrete C 20/25 – $f_{ck,cube} = 25 \text{ N/mm}^2$

		Hilti technical data						
Anchor size		M8	M10	M12	M16	M20	M24	
Embedment depth	$h_{ef,typ} = [\text{mm}]$	80	90	110	125	170	210	
Base material thickness	$h_{min} = [\text{mm}]$	110	120	140	161	218	266	
Edge distance	$c = c_{min} = [\text{mm}]$	40	50	60	80	100	120	
Tensile N_{Rd}: single anchor, min. edge distance ($c = c_{min}$)								
	HIT-V 5.8 HIT-V 8.8 HIT-V-R HIT-V-HCR	[kN]	5,2	7,0	10,4	13,8	23,5	30,7
Shear V_{Rd}: single anchor, min. edge distance ($c = c_{min}$), without lever arm								
	HIT-V 5.8 HIT-V 8.8 HIT-V-R HIT-V-HCR	[kN]	3,7	5,3	7,3	11,5	17,2	23,6

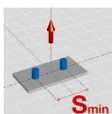
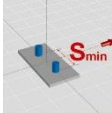
Design resistance: concrete C 20/25 – $f_{ck,cube} = 25 \text{ N/mm}^2$ (load values are valid for single anchor)

		Hilti technical data						
Anchor size		M8	M10	M12	M16	M20	M24	
Embedment depth	$h_{ef,typ} =$ [mm]	80	90	110	125	170	210	
Base material thickness	$h_{min} =$ [mm]	110	120	140	161	218	266	
Spacing	$s = s_{min} =$ [mm]	40	50	60	80	100	120	
Tensile N_{Rd}: double anchor, no edge effects, min. spacing ($s = s_{min}$)								
	HIT-V 5.8	[kN]	5,9	7,8	11,5	14,8	24,9	31,9
	HIT-V 8.8							
	HIT-V-R							
	HIT-V-HCR							
Shear V_{Rd}: double anchor, no edge effects, min. spacing ($s = s_{min}$), without lever arm								
	HIT-V 5.8	[kN]	7,2	12,0	16,8	31,2	48,8	70,4
	HIT-V 8.8	[kN]	12,0	18,4	27,2	36,4	61,0	75,7
	HIT-V-R	[kN]	8,3	12,8	19,2	35,3	55,1	75,7
	HIT-V-HCR	[kN]	12,0	18,4	27,2	36,4	61,0	70,9

Hilti HIT-ICE mortar with HIS-(R)N sleeve

Injection mortar system		Benefits
	Hilti HIT-ICE 296 ml cartridge	<ul style="list-style-type: none"> - suitable for non-cracked concrete C 20/25 to C 50/60 - high loading capacity - suitable for dry and water saturated concrete - odourless resin - low installation temperature (range -23 °C to +32 °C)
	Statik mixer	
	HIS-(R)N sleeve	



Concrete

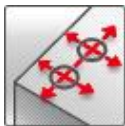

Small edge distance and spacing

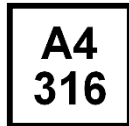

Corrosion resistance



PROFIS Anchor design software

Basic loading data (for a single anchor)

All data in this section applies to

- Correct setting (See setting instruction)
- No edge distance and spacing influence
- Steel failure
- Screw strength class 8.8
- Base material thickness, as specified in the table
- Embedment depth, as specified in the table
- One anchor material, as specified in the tables
- Concrete C 20/25, $f_{ck,cube} = 25 \text{ N/mm}^2$
- Installation temperature range -18°C to +32°C

For details see Simplified design method

Embedment depth and base material thickness for the basic loading data. Mean ultimate resistance, characteristic resistance, design resistance, recommended loads.

Anchor size	M8	M10	M12	M16	M20
Embedment depth [mm]	90	110	125	170	205
Base material thickness [mm]	120	150	170	230	270

Mean ultimate resistance ^{a)}: concrete C 20/25 – $f_{ck,cube} = 25 \text{ N/mm}^2$, anchor HIS-N

			Hilti technical data				
Anchor size			M8	M10	M12	M16	M20
Tensile $N_{Ru,m}$	HIS-N	[kN]	27,3	48,2	61,0	105,6	114,5
Shear $V_{Ru,m}$	HIS-N	[kN]	13,7	24,2	41,0	62,0	57,8

Characteristic resistance: concrete C 20/25 – $f_{ck,cube} = 25 \text{ N/mm}^2$, anchor HIS-N

			Hilti technical data				
Anchor size			M8	M10	M12	M16	M20
Tensile N_{Rk}	HIS-N	[kN]	24,2	36,1	45,8	79,2	94,7
Shear V_{Rk}	HIS-N	[kN]	13,0	23,0	39,0	59,0	55,0

Design resistance: concrete C 20/25 – $f_{ck,cube} = 25 \text{ N/mm}^2$, anchor HIS-N

			Hilti technical data				
Anchor size			M8	M10	M12	M16	M20
Tensile N_{Rd}	HIS-N	[kN]	11,5	17,2	21,8	37,7	45,1
Shear V_{Rd}	HIS-N	[kN]	10,4	18,4	26,0	39,3	36,7

Recommended loads ^{a)}: concrete C 20/25 – $f_{ck,cube} = 25 \text{ N/mm}^2$, anchor HIS-N

			Hilti technical data				
Anchor size			M8	M10	M12	M16	M20
Tensile N_{rec}	HIS-N	[kN]	8,2	12,3	15,6	26,9	32,2
Shear V_{rec}	HIS-N	[kN]	7,4	13,1	18,6	28,1	26,2

a) With overall partial safety factor for action $\gamma = 1,4$. The partial safety factors for action depend on the type of loading and shall be taken from national regulations.

Service temperature range

Hilti HIT-ICE injection mortar may be applied in the temperature ranges given below. An elevated base material temperature may lead to a reduction of the design bond resistance.

Temperature range	Base material temperature	Maximum long term base material temperature	Maximum short term base material temperature
Temperature range I	-40 °C to +70 °C	+43 °C	+70 °C

Max short term base material temperature

Short-term elevated base material temperatures are those that occur over brief intervals, e.g. as a result of diurnal cycling.

Max long term base material temperature

Long-term elevated base material temperatures are roughly constant over significant periods of time.

Materials

Mechanical properties of HIS-(R)N

Anchor size			Hilti technical data				
			M8	M10	M12	M16	M20
Nominal tensile strength f_{uk}	HIS-N	[N/mm ²]	490	490	460	460	460
	Screw 8.8	[N/mm ²]	800	800	800	800	800
	HIS-RN	[N/mm ²]	700	700	700	700	700
	Screw A4-70	[N/mm ²]	700	700	700	700	700
Yield strength f_{yk}	HIS-N	[N/mm ²]	410	410	375	375	375
	Screw 8.8	[N/mm ²]	640	640	640	640	640
	HIS-RN	[N/mm ²]	350	350	350	350	350
	Screw A4-70	[N/mm ²]	450	450	450	450	450
Stressed cross-section A_s	HIS-(R)N	[mm ²]	51,5	108,0	169,1	256,1	237,6
	Screw	[mm ²]	36,6	58	84,3	157	245
Moment of resistance W	HIS-(R)N	[mm ³]	145	430	840	1595	1543
	Screw	[mm ³]	31,2	62,3	109	277	541

Material quality

Part	Material
internally threaded sleeves ^{a)} HIS-N	C-steel 1.0718, steel galvanized $\geq 5\mu\text{m}$
internally threaded sleeves ^{b)} HIS-RN	stainless steel 1.4401 and 1.4571

a) related fastening screw: strength class 8.8, A5 > 8% Ductile steel galvanized $\geq 5\mu\text{m}$

b) related fastening screw: strength class 70, A5 > 8% Ductile stainless steel 1.4401; 1.4404; 1.4578; 1.4571; 1.4439; 1.4362

Anchor dimensions

Anchor size	M8	M10	M12	M16	M20
Internal sleeve HIS-(R)N	M8x90	M10x110	M12x125	M16x170	M20x205
Anchor embedment depth [mm]	90	110	125	170	205

Setting

installation equipment

Anchor size	M8	M10	M12	M16	M20
Rotary hammer	TE 2 – TE 16		TE 40 – TE 50		
Other tools	compressed air gun or blow out pump, set of cleaning brushes, dispenser				

Setting instruction

Dry and water-saturated concrete, hammer drilling

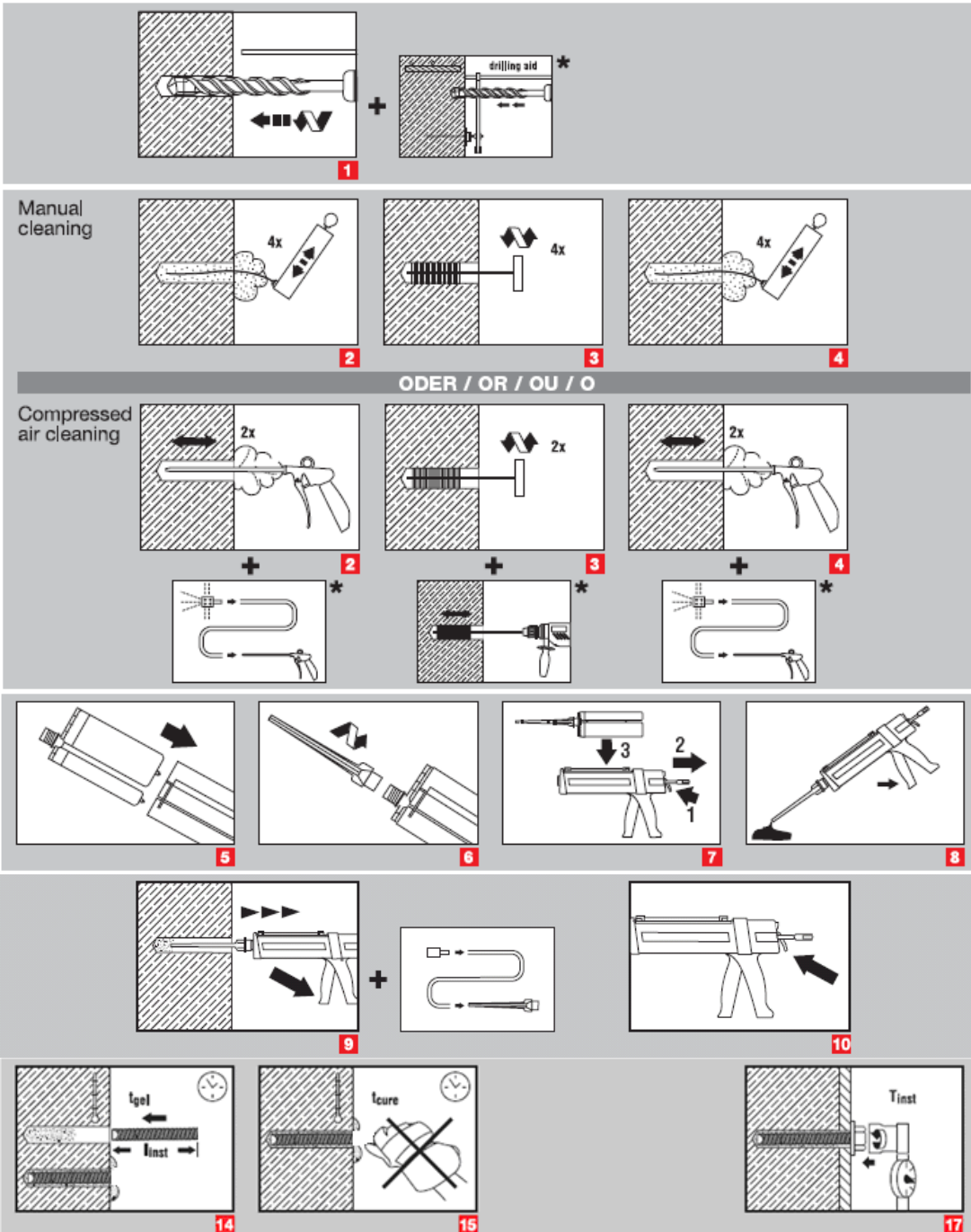
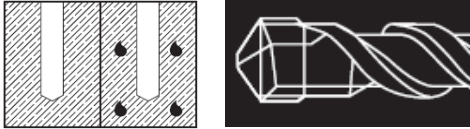

a)

a) Note: Manual cleaning for HIS-(R)N M8 and HIS-(R)N M10 only!

Brush bore hole with required steel brush HIT-RB

For detailed information on installation see instruction for use given with the package of the product.

Curing time for general conditions

Hilti technical data		
Temperature of the base material	Curing time before anchor can be fully loaded t_{cure}	Working time in which anchor can be inserted and adjusted t_{gel}
32 °C	35 min	1 min
21 °C	45 min	2,5 min
16 °C	1 h	5 min
4 °C	1 ½ h	15 min
- 7 °C	6 h	1 h
- 18 °C	24 h	1,5 h
- 23 °C	36 h	1,5 h

Setting details

			Hilti technical data				
Anchor size			M8	M10	M12	M16	M20
Nominal diameter of drill bit	d_0	[mm]	14	18	22	28	32
Diameter of element	d	[mm]	12,5	16,5	20,5	25,4	27,6
Effective anchorage and drill hole depth	h_{ef}	[mm]	90	110	125	170	205
Minimum base material thickness ^{a)}	h_{min}	[mm]	120	150	170	230	270
Diameter of clearance hole in the fixture	d_f	[mm]	9	12	14	18	22
Thread engagement length; min - max	h_s	[mm]	8-20	10-25	12-30	16-40	20-50
Minimum spacing	s_{min}	[mm]	40	45	55	65	90
Minimum edge distance	c_{min}	[mm]	40	45	55	65	90
Critical spacing for splitting failure	$s_{cr,sp}$		$2 c_{cr,sp}$				
Critical edge distance for splitting failure ^{a)}	$c_{cr,sp}$	[mm]	$1,0 \cdot h_{ef}$ for $h / h_{ef} \geq 2,0$				
			$4,6 h_{ef} - 1,8 h$ for $2,0 > h / h_{ef} > 1,3$				
			$2,26 h_{ef}$ for $h / h_{ef} \leq 1,3$				
Critical spacing for concrete cone failure	$s_{cr,N}$		$2 c_{cr,N}$				
Critical edge distance for concrete cone failure	$c_{cr,N}$	^{b)}	$1.5 h_{ef}$				
Torque moment ^{c)}	T_{inst}	[Nm]	10	20	40	80	150

For spacing (edge distance) smaller than critical spacing (critical edge distance) the design loads have to be reduced.

- a) h : base material thickness ($h \geq h_{min}$)
- b) The critical edge distance for concrete cone failure depends on the embedment depth h_{ef} and the design bond resistance. The simplified formula given in this table is on the safe side.
- c) This is the maximum recommended torque moment to avoid splitting failure during installation for anchors with minimum spacing and/or edge distance.

Simplified design method

Simplified version of the design method according ETAG 001, TR 029. Design resistance according data given by Hilti.

- Influence of concrete strength
- Influence of edge distance
- Influence of spacing
- Valid for a group of two anchors. (The method may also be applied for anchor groups with more than two anchors or more than one edge distance. The influencing factors must then be considered for each edge distance and spacing. The calculated design loads are then on the save side: They will be lower than the exact values according ETAG 001, TR 029. To avoid this, it is recommended to use the anchor design software PROFIS anchor)

The design method is based on the following simplification:

- No different loads are acting on individual anchors (no eccentricity)

The values are valid for one anchor.

For more complex fastening applications please use the anchor design software PROFIS Anchor.

Tension loading

The design tensile resistance is the lower value of

- Steel resistance: $N_{Rd,s}$
- Combined pull-out and concrete cone resistance:
 $N_{Rd,p} = N_{Rd,p}^0 \cdot f_{B,p} \cdot f_{1,N} \cdot f_{2,N} \cdot f_{3,N} \cdot f_{h,p} \cdot f_{re,N}$
- Concrete cone resistance: $N_{Rd,c} = N_{Rd,c}^0 \cdot f_B \cdot f_{1,N} \cdot f_{2,N} \cdot f_{3,N} \cdot f_{h,N} \cdot f_{re,N}$
- Concrete splitting resistance (only non-cracked concrete):
 $N_{Rd,sp} = N_{Rd,c}^0 \cdot f_B \cdot f_{1,sp} \cdot f_{2,sp} \cdot f_{3,sp} \cdot f_{h,N} \cdot f_{re,N}$

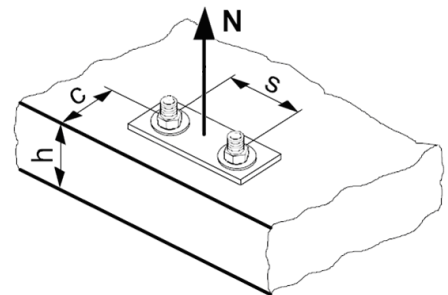

Basic design tensile resistance

Design steel resistance $N_{Rd,s}$

		Hilti technical data				
Anchor size		M8	M10	M12	M16	M20
$N_{Rd,s}$	HIS-N [kN]	17,4	30,7	44,7	80,3	74,1
	HIS-RN [kN]	13,9	21,9	31,6	58,8	69,2

Design combined pull-out and concrete cone resistance

$$N_{Rd,p} = N_{Rd,p}^0 \cdot f_{B,p} \cdot f_{1,N} \cdot f_{2,N} \cdot f_{3,N} \cdot f_{h,p} \cdot f_{re,N}$$

		Hilti technical data				
Anchor size		M8	M10	M12	M16	M20
Embedment depth h_{ef} [mm]		90	110	125	170	205
$N_{Rd,p}^0$	Temperature range I [kN]	11,5	17,2	21,8	37,7	45,1

Design concrete cone resistance $N_{Rd,c} = N_{Rd,c}^0 \cdot f_B \cdot f_{1,N} \cdot f_{2,N} \cdot f_{3,N} \cdot f_{h,N} \cdot f_{re,N}$

Design splitting resistance $N_{Rd,sp} = N_{Rd,c}^0 \cdot f_B \cdot f_{1,sp} \cdot f_{2,sp} \cdot f_{3,sp} \cdot f_{h,N} \cdot f_{re,N}$

		Hilti technical data				
Anchor size		M8	M10	M12	M16	M20
$N_{Rd,c}^0$	[kN]	20,5	27,7	33,6	53,3	70,6

Influencing factors

Influence of concrete strength on combined pull-out and concrete cone resistance

Concrete strength designation (ENV 206)	C 20/25	C 25/30	C 30/37	C 35/45	C 40/50	C 45/55	C 50/60
$f_{B,p} = (f_{ck,cube}/25N/mm^2)^{0,1}$ a)	1	1,02	1,04	1,06	1,07	1,08	1,09

a) $f_{ck,cube}$ = concrete compressive strength, measured on cubes with 150 mm side length

Influence of embedment depth on combined pull-out and concrete cone resistance

$f_{h,p} = 1$

Influence of concrete strength on concrete cone resistance

Concrete strength designation (ENV 206)	C 20/25	C 25/30	C 30/37	C 35/45	C 40/50	C 45/55	C 50/60
$f_B = (f_{ck,cube}/25N/mm^2)^{1/2}$ a)	1	1,1	1,22	1,34	1,41	1,48	1,55

a) $f_{ck,cube}$ = concrete compressive strength, measured on cubes with 150 mm side length

Influence of edge distance a)

$c/c_{cr,N}$	0,1	0,2	0,3	0,4	0,5	0,6	0,7	0,8	0,9	1
$c/c_{cr,sp}$										
$f_{1,N} = 0,7 + 0,3 \cdot c/c_{cr,N}$	0,73	0,76	0,79	0,82	0,85	0,88	0,91	0,94	0,97	1
$f_{1,sp} = 0,7 + 0,3 \cdot c/c_{cr,sp}$										
$f_{2,N} = 0,5 \cdot (1 + c/c_{cr,N})$	0,55	0,60	0,65	0,70	0,75	0,80	0,85	0,90	0,95	1
$f_{2,sp} = 0,5 \cdot (1 + c/c_{cr,sp})$										

a) The the edge distance shall not be smaller than the minimum edge distance c_{min} given in the table with the setting details. These influencing factors must be considered for every edge distance smaller than the critical edge distance.

Influence of anchor spacing a)

$s/s_{cr,N}$	0,1	0,2	0,3	0,4	0,5	0,6	0,7	0,8	0,9	1
$s/s_{cr,sp}$										
$f_{3,N} = 0,5 \cdot (1 + s/s_{cr,N})$	0,55	0,60	0,65	0,70	0,75	0,80	0,85	0,90	0,95	1
$f_{3,sp} = 0,5 \cdot (1 + s/s_{cr,sp})$										

a) The anchor spacing shall not be smaller than the minimum anchor spacing s_{min} given in the table with the setting details. This influencing factor must be considered for every anchor spacing.

Influence of embedment depth on concrete cone resistance

$f_{h,N} = 1$

Influence of reinforcement

h_{ef} [mm]	80	90	≥ 100
$f_{re,N} = 0.5 + h_{ef}/200\text{mm} \leq 1$	0.9 ^{a)}	0.95 ^{a)}	1

a) This factor applies only for dense reinforcement. If in the area of anchorage there is reinforcement with a spacing ≥ 150 mm (any diameter) or with a diameter ≤ 10 mm and a spacing ≥ 100 mm, then a factor $f_{re,N} = 1$ may be applied.

Shear loading

The design shear resistance is the lower value of

- Steel resistance: $V_{Rd,s}$
- Concrete pryout resistance: $V_{Rd,cp} = k \cdot \text{lower value of } N_{Rd,p} \text{ and } N_{Rd,c}$
- Concrete edge resistance: $V_{Rd,c} = V_{Rd,c}^0 \cdot f_B \cdot f_{\beta} \cdot f_h \cdot f_4 \cdot f_{hef} \cdot f_c$

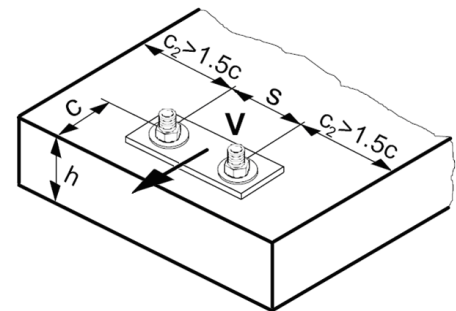

Basic design shear resistance

Design steel resistance $V_{Rd,s}$

Anchor size		Hilti technical data				
		M8	M10	M12	M16	M20
$V_{Rd,s}$	HIS-N [kN]	10,4	18,4	26,0	39,3	36,7
	HIS-RN [kN]	8,3	12,8	19,2	35,3	41,5

Design concrete pryout resistance $V_{Rd,cp} = \text{lower value } ^a) \text{ of } k \cdot N_{Rd,p} \text{ and } k \cdot N_{Rd,c}$

$$k = 1 \text{ for } h_{ef} < 60 \text{ mm}$$

$$k = 2 \text{ for } h_{ef} \geq 60 \text{ mm}$$

- a) $N_{Rd,p}$: Design combined pull-out and concrete cone resistance
 $N_{Rd,c}$: Design concrete cone resistance

Design concrete edge resistance $V_{Rd,c} = V_{Rd,c}^0 \cdot f_B \cdot f_{\beta} \cdot f_h \cdot f_4 \cdot f_{hef} \cdot f_c$

Anchor size	M8	M10	M12	M16	M20
Non-cracked concrete					
$V_{Rd,c}^0$ [kN]	12,4	19,6	28,2	40,2	46,2

Influencing factors

Influence of concrete strength

Concrete strength designation (ENV 206)	C 20/25	C 25/30	C 30/37	C 35/45	C 40/50	C 45/55	C 50/60
$f_B = (f_{ck,cube}/25\text{N/mm}^2)^{1/2 \text{ a)}$	1	1,1	1,22	1,34	1,41	1,48	1,55

- a) $f_{ck,cube}$ = concrete compressive strength, measured on cubes with 150 mm side length

Influence of angle between load applied and the direction perpendicular to the free edge

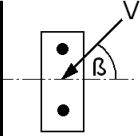
Angle β	0°	10°	20°	30°	40°	50°	60°	70°	80°	≥ 90°
$f_{\beta} = \frac{1}{\sqrt{(\cos \alpha_v)^2 + \left(\frac{\sin \alpha_v}{2,5}\right)^2}}$ 	1	1,01	1,05	1,13	1,24	1,40	1,64	1,97	2,32	2,50

Influence of base material thickness

h/c	0,15	0,3	0,45	0,6	0,75	0,9	1,05	1,2	1,35	≥ 1,5
$f_h = \{h/(1,5 \cdot c)\}^{1/2} \leq 1$	0,32	0,45	0,55	0,63	0,71	0,77	0,84	0,89	0,95	1,00

Influence of anchor spacing and edge distance ^{a)} for concrete edge resistance: f_4

$$f_4 = (c/h_{ef})^{1,5} \cdot (1 + s / [3 \cdot c]) \cdot 0,5$$

c/h _{ef}	Single anchor	Group of two anchors s/h _{ef}														
		0,75	1,50	2,25	3,00	3,75	4,50	5,25	6,00	6,75	7,50	8,25	9,00	9,75	10,50	11,25
0,50	0,35	0,27	0,35	0,35	0,35	0,35	0,35	0,35	0,35	0,35	0,35	0,35	0,35	0,35	0,35	0,35
0,75	0,65	0,43	0,54	0,65	0,65	0,65	0,65	0,65	0,65	0,65	0,65	0,65	0,65	0,65	0,65	0,65
1,00	1,00	0,63	0,75	0,88	1,00	1,00	1,00	1,00	1,00	1,00	1,00	1,00	1,00	1,00	1,00	1,00
1,25	1,40	0,84	0,98	1,12	1,26	1,40	1,40	1,40	1,40	1,40	1,40	1,40	1,40	1,40	1,40	1,40
1,50	1,84	1,07	1,22	1,38	1,53	1,68	1,84	1,84	1,84	1,84	1,84	1,84	1,84	1,84	1,84	1,84
1,75	2,32	1,32	1,49	1,65	1,82	1,98	2,15	2,32	2,32	2,32	2,32	2,32	2,32	2,32	2,32	2,32
2,00	2,83	1,59	1,77	1,94	2,12	2,30	2,47	2,65	2,83	2,83	2,83	2,83	2,83	2,83	2,83	2,83
2,25	3,38	1,88	2,06	2,25	2,44	2,63	2,81	3,00	3,19	3,38	3,38	3,38	3,38	3,38	3,38	3,38
2,50	3,95	2,17	2,37	2,57	2,77	2,96	3,16	3,36	3,56	3,76	3,95	3,95	3,95	3,95	3,95	3,95
2,75	4,56	2,49	2,69	2,90	3,11	3,32	3,52	3,73	3,94	4,15	4,35	4,56	4,56	4,56	4,56	4,56
3,00	5,20	2,81	3,03	3,25	3,46	3,68	3,90	4,11	4,33	4,55	4,76	4,98	5,20	5,20	5,20	5,20
3,25	5,86	3,15	3,38	3,61	3,83	4,06	4,28	4,51	4,73	4,96	5,18	5,41	5,63	5,86	5,86	5,86
3,50	6,55	3,51	3,74	3,98	4,21	4,44	4,68	4,91	5,14	5,38	5,61	5,85	6,08	6,31	6,55	6,55
3,75	7,26	3,87	4,12	4,36	4,60	4,84	5,08	5,33	5,57	5,81	6,05	6,29	6,54	6,78	7,02	7,26
4,00	8,00	4,25	4,50	4,75	5,00	5,25	5,50	5,75	6,00	6,25	6,50	6,75	7,00	7,25	7,50	7,75
4,25	8,76	4,64	4,90	5,15	5,41	5,67	5,93	6,18	6,44	6,70	6,96	7,22	7,47	7,73	7,99	8,25
4,50	9,55	5,04	5,30	5,57	5,83	6,10	6,36	6,63	6,89	7,16	7,42	7,69	7,95	8,22	8,49	8,75
4,75	10,35	5,45	5,72	5,99	6,27	6,54	6,81	7,08	7,36	7,63	7,90	8,17	8,45	8,72	8,99	9,26
5,00	11,18	5,87	6,15	6,43	6,71	6,99	7,27	7,55	7,83	8,11	8,39	8,66	8,94	9,22	9,50	9,78
5,25	12,03	6,30	6,59	6,87	7,16	7,45	7,73	8,02	8,31	8,59	8,88	9,17	9,45	9,74	10,02	10,31
5,50	12,90	6,74	7,04	7,33	7,62	7,92	8,21	8,50	8,79	9,09	9,38	9,67	9,97	10,26	10,55	10,85

a) The anchor spacing and the edge distance shall not be smaller than the minimum anchor spacing s_{min} and the minimum edge distance c_{min} .

Influence of embedment depth

Anchor size	M8	M10	M12	M16	M20
$f_{hef} =$	1,38	1,21	1,04	1,22	1,45

Influence of edge distance ^{a)}

c/d	4	6	8	10	15	20	30	40
$f_c = (d/c)^{0,19}$	0,77	0,71	0,67	0,65	0,60	0,57	0,52	0,50

a) The edge distance shall not be smaller than the minimum edge distance c_{min} .

Combined tension and shear loading

For combined tension and shear loading see section “Anchor Design”.

Precalculated values

Recommended loads can be calculated by dividing the design resistance by an overall partial safety factor for action $\gamma = 1,4$. The partial safety factors for action depend on the type of loading and shall be taken from national regulations.

Design resistance: concrete C 20/25 – $f_{ck,cube} = 25 \text{ N/mm}^2$

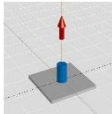
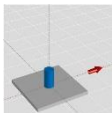
		Hilti technical data				
Anchor size		M8	M10	M12	M16	M20
Embedment depth	$h_{ef} = [\text{mm}]$	90	110	125	170	205
Base material thickness	$h_{min} = [\text{mm}]$	120	150	170	230	270
	Tensile N_{Rd}: single anchor, no edge effects					
	HIS-(R)N [kN]	11,5	17,2	21,8	37,7	45,1
	Shear V_{Rd}: single anchor, no edge effects, without lever arm					
	HIS-N [kN]	10,4	18,4	26,0	39,3	36,7
	HIS-RN [kN]	8,3	12,8	19,2	35,3	41,5

Design resistance: concrete C 20/25 – $f_{ck,cube} = 25 \text{ N/mm}^2$

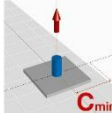
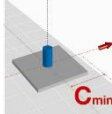
		Hilti technical data				
Anchor size		M8	M10	M12	M16	M20
Embedment depth	$h_{ef} = [\text{mm}]$	90	110	125	170	205
Base material thickness	$h_{min} = [\text{mm}]$	120	150	170	230	270
Edge distance	$c = c_{min} = [\text{mm}]$	40	45	55	65	90
	Tensile N_{Rd}: single anchor, min. edge distance ($c = c_{min}$)					
	HIS-(R)N [kN]	6,1	8,8	11,3	19,1	25,5
	Shear V_{Rd}: single anchor, min. edge distance ($c = c_{min}$), without lever arm					
	HIS-(R)N [kN]	4,2	5,5	7,6	10,8	17,2

**Design resistance: concrete C 20/25 – $f_{ck,cube} = 25 \text{ N/mm}^2$
(load values are valid for single anchor)**

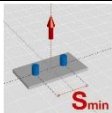
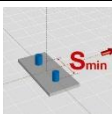
		Hilti technical data				
Anchor size		M8	M10	M12	M16	M20
Embedment depth	$h_{ef} = [\text{mm}]$	90	110	125	170	205
Base material thickness	$h_{min} = [\text{mm}]$	120	150	170	230	270
Spacing	$s = s_{min} = [\text{mm}]$	40	45	55	65	90
	Tensile N_{Rd}: double anchor, no edge effects, min. spacing ($s = s_{min}$)					
	HIS-(R)N [kN]	7,7	11,2	14,1	23,8	29,9
	Shear V_{Rd}: double anchor, no edge effects, min. spacing ($s = s_{min}$), without lever arm					
	HIS-N [kN]	10,4	18,4	26,0	39,3	36,7
	HIS-RN [kN]	8,3	12,8	19,2	35,3	41,5

Hilti HIT-ICE mortar with rebar (as anchor)

Injection mortar system	Benefits
 <p>Hilti HIT-ICE 296 ml cartridge</p>	<ul style="list-style-type: none"> - suitable for non-cracked concrete C 20/25 to C 50/60 - high loading capacity - suitable for dry and water saturated concrete - high corrosion resistant - odourless resin - low installation temperature (range -23 °C – 32 °C)
 <p>Statik mixer</p>	
 <p>rebar BSt 500 S</p>	



Concrete

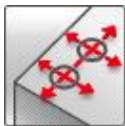

Small edge distance and spacing

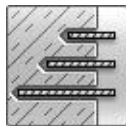

Variable embedment depth



PROFIS Anchor design software

Basic loading data (for a single anchor)

All data in this section applies to

- Correct setting (See setting instruction)
- No edge distance and spacing influence
- Steel failure
- Base material thickness, as specified in the table
- One typical embedment depth, as specified in the table
- One anchor material, as specified in the tables
- Concrete C 20/25, $f_{ck,cube} = 25 \text{ N/mm}^2$
- Installation temperature range -18°C to +32°C

For details see Simplified design method

Embedment depth ^{a)} and base material thickness for the basic loading data. Mean ultimate resistance, characteristic resistance, design resistance, recommended loads.

Anchor size	Hilti technical data						
	Ø8	Ø10	Ø12	Ø14	Ø16	Ø20	Ø25
Typical embedment depth [mm]	80	90	110	125	125	170	210
Base material thickness [mm]	110	120	145	165	165	220	275

a) The allowed range of embedment depth is shown in the setting details. The corresponding load values can be calculated according to the simplified design method.

Mean ultimate resistance: concrete C 20/25 – $f_{ck,cube} = 25 \text{ N/mm}^2$, anchor rebar BSt 500S

			Hilti technical data						
Anchor size			Ø8	Ø10	Ø12	Ø14	Ø16	Ø20	Ø25
Tensile $N_{Ru,m}$	BSt 500 S	[kN]	20,2	28,3	40,0	51,8	63,6	84,6	105,8
Shear $V_{Ru,m}$	BSt 500 S	[kN]	14,7	23,1	32,6	44,1	57,8	90,3	141,8

Characteristic resistance: concrete C 20/25 – $f_{ck,cube} = 25 \text{ N/mm}^2$, anchor rebar BSt 500 S

			Hilti technical data						
Anchor size			Ø8	Ø10	Ø12	Ø14	Ø16	Ø20	Ø25
Tensile N_{Rk}	BSt 500 S	[kN]	15,1	21,2	30,0	38,9	47,7	63,4	79,4
Shear V_{Rk}	BSt 500 S	[kN]	14,0	22,0	31,0	42,0	55,0	86,0	135,0

Design resistance: concrete C 20/25 – $f_{ck,cube} = 25 \text{ N/mm}^2$, anchor rebar BSt 500 S

			Hilti technical data						
Anchor size			Ø8	Ø10	Ø12	Ø14	Ø16	Ø20	Ø25
Tensile N_{Rd}	BSt 500 S	[kN]	7,2	10,1	14,3	18,5	22,7	30,2	37,8
Shear V_{Rd}	BSt 500 S	[kN]	9,3	14,7	20,7	28,0	36,7	57,3	90,0

Recommended loads ^{a)}: concrete C 20/25 – $f_{ck,cube} = 25 \text{ N/mm}^2$, anchor rebar BSt 500 S

			Hilti technical data						
Anchor size			Ø8	Ø10	Ø12	Ø14	Ø16	Ø20	Ø25
Tensile N_{rec}	BSt 500 S	[kN]	5,1	7,2	10,2	13,2	16,2	21,6	27,0
Shear V_{rec}	BSt 500 S	[kN]	6,7	10,5	14,8	20,0	26,2	41,0	64,3

a) With overall partial safety factor for action $\gamma = 1,4$. The partial safety factors for action depend on the type of loading and shall be taken from national regulations.

Service temperature range

Hilti HIT-ICE injection mortar may be applied in the temperature ranges given below. An elevated base material temperature may lead to a reduction of the design bond resistance.

Temperature range	Base material temperature	Maximum long term base material temperature	Maximum short term base material temperature
Temperature range I	-40 °C to +40 °C	+43 °C	+70 °C

Max short term base material temperature

Short-term elevated base material temperatures are those that occur over brief intervals, e.g. as a result of diurnal cycling.

Max long term base material temperature

Long-term elevated base material temperatures are roughly constant over significant periods of time.

Materials

Mechanical properties of rebar BSt 500S

Anchor size			Hilti technical data						
			Ø8	Ø10	Ø12	Ø14	Ø16	Ø20	Ø25
Nominal tensile strength f_{uk}	BSt 500 S	[N/mm ²]	550	550	550	550	550	550	550
Yield strength f_{yk}		[N/mm ²]	500	500	500	500	500	500	500
Stressed cross-section A_s	BSt 500 S	[mm ²]	50,3	78,5	113,1	153,9	201,1	314,2	490,9
Moment of resistance W	BSt 500 S	[mm ³]	50,3	98,2	169,6	269,4	402,1	785,4	1534

Material quality

Part	Material
rebar BSt 500 S	Geometry and mechanical properties according to DIN 488-2:1986 or E DIN 488-2:2006

Setting

installation equipment

Anchor size	Ø8	Ø10	Ø12	Ø14	Ø16	Ø20	Ø25
Rotary hammer	TE 2 – TE 16					TE 40 – TE 70	
Other tools	compressed air gun or blow out pump, set of cleaning brushes, dispenser						

Setting instruction

Dry and water-saturated concrete, hammer drilling



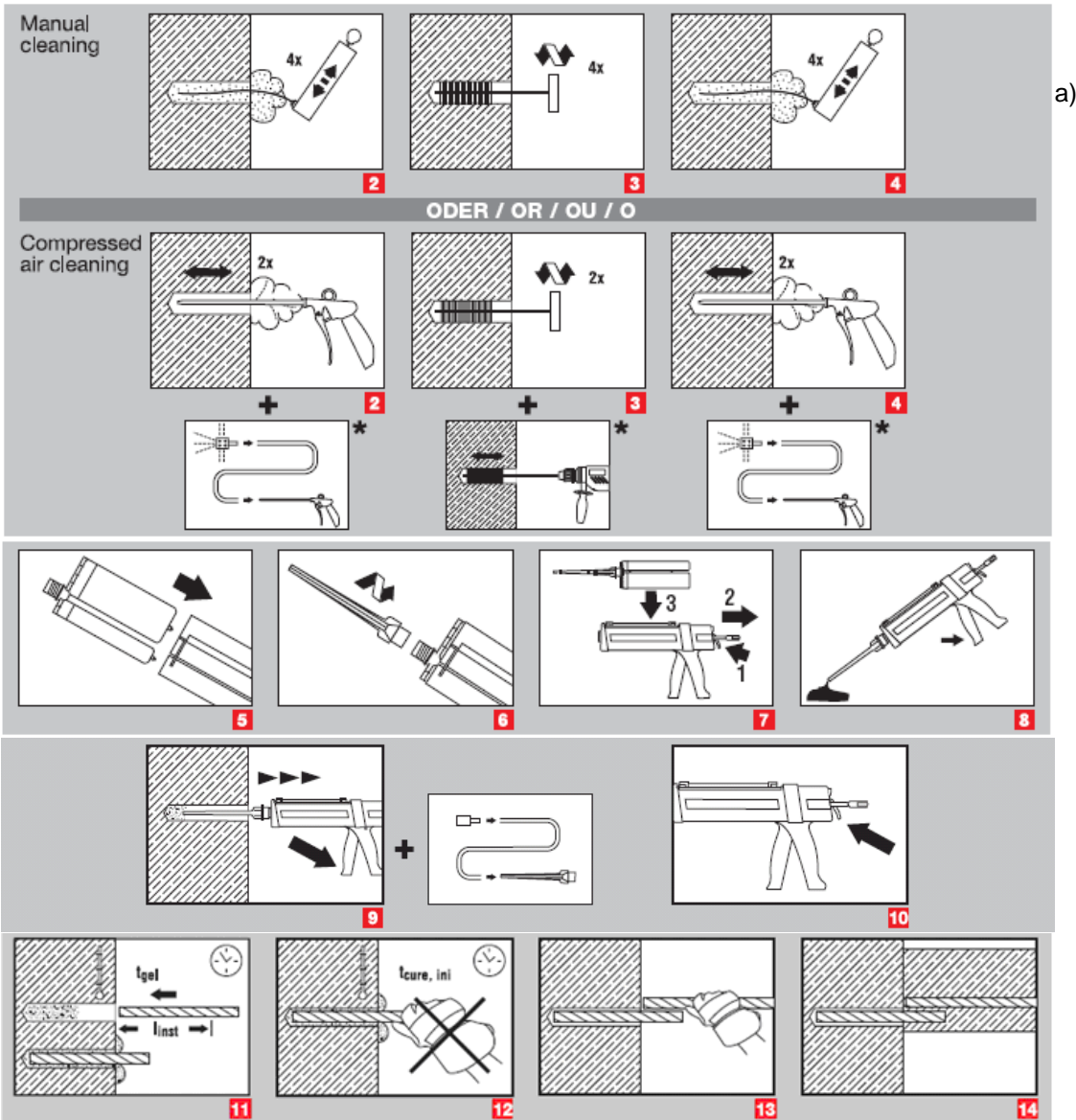

a)

a) Note: Manual cleaning for element sizes $d \leq 16\text{mm}$ and embedment depth $h_{ef} \leq 10 d$ only!

Brush bore hole with required steel brush HIT-RB

For detailed information on installation see instruction for use given with the package of the product.

Curing time for general conditions

Hilti technical data		
Temperature of the base material	Curing time before anchor can be fully loaded t_{cure}	Working time in which anchor can be inserted and adjusted t_{gel}
32 °C	35 min	1 min
21 °C	45 min	2,5 min
16 °C	1 h	5 min
4 °C	1 ½ h	15 min
- 7 °C	6 h	1 h
- 18 °C	24 h	1,5 h
- 23 °C	36 h	1,5 h

Setting details

Anchor size			Hilti technical data						
			Ø8	Ø10	Ø12	Ø14	Ø16	Ø20	Ø25
Nominal diameter of drill bit	d_0	[mm]	12	14	16	18	20	25	32
Effective anchorage and drill hole depth	h_{ef}	[mm]	80	90	110	125	125	170	210
Minimum base material thickness ^{a)}	h_{min}	[mm]	$h_{ef} + 30 \text{ mm}$ $\geq 100 \text{ mm}$		$h_{ef} + 2 d_0$				
Minimum spacing	s_{min}	[mm]	40	50	60	70	80	100	125
Minimum edge distance	c_{min}	[mm]	40	50	60	70	80	100	125
Critical spacing for splitting failure	$s_{cr,sp}$		$2 c_{cr,sp}$						
Critical edge distance for splitting failure ^{b)}	$c_{cr,sp}$	[mm]	$1,0 \cdot h_{ef}$ for $h / h_{ef} \geq 2,0$						
			$4,6 h_{ef} - 1,8 h$ for $2,0 > h / h_{ef} > 1,3$						
			$2,26 h_{ef}$ for $h / h_{ef} \leq 1,3$						
Critical spacing for concrete cone failure	$s_{cr,N}$		$2 c_{cr,N}$						
Critical edge distance for concrete cone failure ^{c)}	$c_{cr,N}$		$1.5 h_{ef}$						

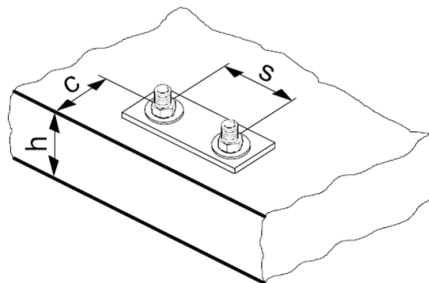

For spacing (edge distance) smaller than critical spacing (critical edge distance) the design loads have to be reduced.

- a) h : base material thickness ($h \geq h_{min}$)
- b) The critical edge distance for concrete cone failure depends on the embedment depth h_{ef} and the design bond resistance. The simplified formula given in this table is on the save side.

Simplified design method

Simplified version of the design method according ETAG 001, TR 029. Design resistance according data given by Hilti.

- Influence of concrete strength
- Influence of edge distance
- Influence of spacing
- Valid for a group of two anchors. (The method may also be applied for anchor groups with more than two anchors or more than one edge distance. The influencing factors must then be considered for each edge distance and spacing. The calculated design loads are then on the save side: They will be lower than the exact values according ETAG 001, TR 029. To avoid this, it is recommended to use the anchor design software PROFIS anchor)

The design method is based on the following simplification:

- No different loads are acting on individual anchors (no eccentricity)

The values are valid for one anchor.

For more complex fastening applications please use the anchor design software PROFIS Anchor.

Tension loading

The design tensile resistance is the lower value of

- Steel resistance: $N_{Rd,s}$
- Combined pull-out and concrete cone resistance: $N_{Rd,p} = N_{Rd,p}^0 \cdot f_{B,p} \cdot f_{1,N} \cdot f_{2,N} \cdot f_{3,N} \cdot f_{h,p} \cdot f_{re,N}$
- Concrete cone resistance: $N_{Rd,c} = N_{Rd,c}^0 \cdot f_B \cdot f_{1,N} \cdot f_{2,N} \cdot f_{3,N} \cdot f_{h,N} \cdot f_{re,N}$
- Concrete splitting resistance (only non-cracked concrete): $N_{Rd,sp} = N_{Rd,c}^0 \cdot f_B \cdot f_{1,sp} \cdot f_{2,sp} \cdot f_{3,sp} \cdot f_{h,N} \cdot f_{re,N}$

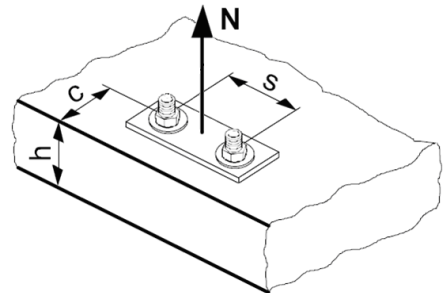

Basic design tensile resistance

Design steel resistance $N_{Rd,s}$

		Hilti technical data						
Anchor size		Ø8	Ø10	Ø12	Ø14	Ø16	Ø20	Ø25
$N_{Rd,s}$	BSt 500 S [kN]	20,0	30,7	44,3	60,7	79,3	123,6	192,9

Design combined pull-out and concrete cone resistance

$$N_{Rd,p} = N_{Rd,p}^0 \cdot f_{B,p} \cdot f_{1,N} \cdot f_{2,N} \cdot f_{3,N} \cdot f_{h,p} \cdot f_{re,N}$$

		Hilti technical data						
Anchor size		Ø8	Ø10	Ø12	Ø14	Ø16	Ø20	Ø25
Typical embedment depth $h_{ef,typ}$ [mm]		80	90	110	125	125	170	210
$N_{Rd,p}^0$	Temperature range I [kN]	7,2	10,1	14,3	18,5	22,7	30,2	37,8

$$\text{Design concrete cone resistance } N_{Rd,c} = N_{Rd,c}^0 \cdot f_B \cdot f_{1,N} \cdot f_{2,N} \cdot f_{3,N} \cdot f_{h,N} \cdot f_{re,N}$$

$$\text{Design splitting resistance } N_{Rd,sp} = N_{Rd,c}^0 \cdot f_B \cdot f_{1,sp} \cdot f_{2,sp} \cdot f_{3,sp} \cdot f_{h,N} \cdot f_{re,N}$$

		Hilti technical data						
Anchor size		Ø8	Ø10	Ø12	Ø14	Ø16	Ø20	Ø25
$N_{Rd,c}^0$	[kN]	17,2	20,5	27,7	33,6	33,6	53,3	73,2

Influencing factors

Influence of concrete strength on combined pull-out and concrete cone resistance

Concrete strength designation (ENV 206)	C 20/25	C 25/30	C 30/37	C 35/45	C 40/50	C 45/55	C 50/60
$f_{B,p} = (f_{ck,cube}/25N/mm^2)^{0,1}$ ^{a)}	1	1,02	1,04	1,06	1,07	1,08	1,09

a) $f_{ck,cube}$ = concrete compressive strength, measured on cubes with 150 mm side length

Influence of embedment depth on combined pull-out and concrete cone resistance

$f_{h,p} = 1$

Influence of concrete strength on concrete cone resistance

Concrete strength designation (ENV 206)	C 20/25	C 25/30	C 30/37	C 35/45	C 40/50	C 45/55	C 50/60
$f_B = (f_{ck,cube}/25N/mm^2)^{1/2}$ ^{a)}	1	1,1	1,22	1,34	1,41	1,48	1,55

a) $f_{ck,cube}$ = concrete compressive strength, measured on cubes with 150 mm side length

Influence of embedment depth on concrete cone resistance

$f_{h,N} = 1$

Influence of edge distance ^{a)}

$c/c_{cr,N}$	0,1	0,2	0,3	0,4	0,5	0,6	0,7	0,8	0,9	1
$c/c_{cr,sp}$										
$f_{1,N} = 0,7 + 0,3 \cdot c/c_{cr,N}$	0,73	0,76	0,79	0,82	0,85	0,88	0,91	0,94	0,97	1
$f_{1,sp} = 0,7 + 0,3 \cdot c/c_{cr,sp}$										
$f_{2,N} = 0,5 \cdot (1 + c/c_{cr,N})$	0,55	0,60	0,65	0,70	0,75	0,80	0,85	0,90	0,95	1
$f_{2,sp} = 0,5 \cdot (1 + c/c_{cr,sp})$										

a) The edge distance shall not be smaller than the minimum edge distance c_{min} given in the table with the setting details. These influencing factors must be considered for every edge distance smaller than the critical edge distance.

Influence of anchor spacing ^{a)}

$s/s_{cr,N}$	0,1	0,2	0,3	0,4	0,5	0,6	0,7	0,8	0,9	1
$s/s_{cr,sp}$										
$f_{3,N} = 0,5 \cdot (1 + s/s_{cr,N})$	0,55	0,60	0,65	0,70	0,75	0,80	0,85	0,90	0,95	1
$f_{3,sp} = 0,5 \cdot (1 + s/s_{cr,sp})$										

a) The anchor spacing shall not be smaller than the minimum anchor spacing s_{min} given in the table with the setting details. This influencing factor must be considered for every anchor spacing.

Influence of reinforcement

h_{ef} [mm]	80	90	≥ 100
$f_{re,N} = 0,5 + h_{ef}/200mm \leq 1$	0,9 ^{a)}	0,95 ^{a)}	1

a) This factor applies only for dense reinforcement. If in the area of anchorage there is reinforcement with a spacing ≥ 150 mm (any diameter) or with a diameter ≤ 10 mm and a spacing ≥ 100 mm, then a factor $f_{re,N} = 1$ may be applied.

Shear loading

The design shear resistance is the lower value of

- Steel resistance: $V_{Rd,s}$
- Concrete pryout resistance: $V_{Rd,cp} = k \cdot \text{lower value of } N_{Rd,p} \text{ and } N_{Rd,c}$
- Concrete edge resistance: $V_{Rd,c} = V_{Rd,c}^0 \cdot f_B \cdot f_{\beta} \cdot f_h \cdot f_4 \cdot f_{hef} \cdot f_c$

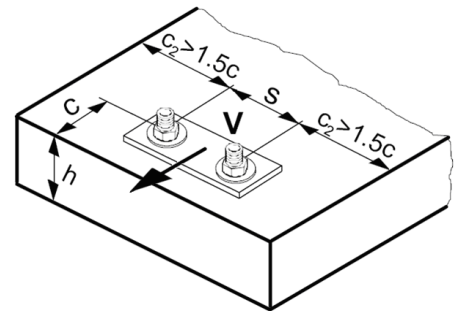

Basic design shear resistance

Design steel resistance $V_{Rd,s}$

Anchor size	Hilti technical data						
	Ø8	Ø10	Ø12	Ø14	Ø16	Ø20	Ø25
$V_{Rd,s}$ BSt 500 S [kN]	9,3	14,7	20,7	28,0	36,7	57,3	90,0

Design concrete pryout resistance $V_{Rd,cp} = \text{lower value}^a$ of $k \cdot N_{Rd,p}$ and $k \cdot N_{Rd,c}$

$$k = 2$$

- a) $N_{Rd,p}$: Design combined pull-out and concrete cone resistance
 $N_{Rd,c}$: Design concrete cone resistance

Design concrete edge resistance $V_{Rd,c} = V_{Rd,c}^0 \cdot f_B \cdot f_{\beta} \cdot f_h \cdot f_4 \cdot f_{hef} \cdot f_c$

Anchor size	Ø8	Ø10	Ø12	Ø14	Ø16	Ø20	Ø25
Non-cracked concrete							
$V_{Rd,c}^0$ [kN]	5,9	8,6	11,6	15,0	18,7	27,0	39,2

Influencing factors

Influence of concrete strength

Concrete strength designation (ENV 206)	C 20/25	C 25/30	C 30/37	C 35/45	C 40/50	C 45/55	C 50/60
$f_B = (f_{ck,cube}/25N/mm^2)^{1/2}$ a)	1	1,1	1,22	1,34	1,41	1,48	1,55

- a) $f_{ck,cube}$ = concrete compressive strength, measured on cubes with 150 mm side length

Influence of angle between load applied and the direction perpendicular to the free edge

Angle β	0°	10°	20°	30°	40°	50°	60°	70°	80°	≥ 90°
$f_{\beta} = \frac{1}{\sqrt{(\cos \alpha_v)^2 + \left(\frac{\sin \alpha_v}{2,5}\right)^2}}$	1	1,01	1,05	1,13	1,24	1,40	1,64	1,97	2,32	2,50

Influence of base material thickness

h/c	0,15	0,3	0,45	0,6	0,75	0,9	1,05	1,2	1,35	≥ 1,5
$f_h = \{h/(1,5 \cdot c)\}^{1/2} \leq 1$	0,32	0,45	0,55	0,63	0,71	0,77	0,84	0,89	0,95	1,00

Influence of anchor spacing and edge distance ^{a)} for concrete edge resistance: f_4

$$f_4 = (c/h_{ef})^{1,5} \cdot (1 + s / [3 \cdot c]) \cdot 0,5$$

c/h _{ef}	Single anchor	Group of two anchors s/h _{ef}														
		0,75	1,50	2,25	3,00	3,75	4,50	5,25	6,00	6,75	7,50	8,25	9,00	9,75	10,50	11,25
0,50	0,35	0,27	0,35	0,35	0,35	0,35	0,35	0,35	0,35	0,35	0,35	0,35	0,35	0,35	0,35	0,35
0,75	0,65	0,43	0,54	0,65	0,65	0,65	0,65	0,65	0,65	0,65	0,65	0,65	0,65	0,65	0,65	0,65
1,00	1,00	0,63	0,75	0,88	1,00	1,00	1,00	1,00	1,00	1,00	1,00	1,00	1,00	1,00	1,00	1,00
1,25	1,40	0,84	0,98	1,12	1,26	1,40	1,40	1,40	1,40	1,40	1,40	1,40	1,40	1,40	1,40	1,40
1,50	1,84	1,07	1,22	1,38	1,53	1,68	1,84	1,84	1,84	1,84	1,84	1,84	1,84	1,84	1,84	1,84
1,75	2,32	1,32	1,49	1,65	1,82	1,98	2,15	2,32	2,32	2,32	2,32	2,32	2,32	2,32	2,32	2,32
2,00	2,83	1,59	1,77	1,94	2,12	2,30	2,47	2,65	2,83	2,83	2,83	2,83	2,83	2,83	2,83	2,83
2,25	3,38	1,88	2,06	2,25	2,44	2,63	2,81	3,00	3,19	3,38	3,38	3,38	3,38	3,38	3,38	3,38
2,50	3,95	2,17	2,37	2,57	2,77	2,96	3,16	3,36	3,56	3,76	3,95	3,95	3,95	3,95	3,95	3,95
2,75	4,56	2,49	2,69	2,90	3,11	3,32	3,52	3,73	3,94	4,15	4,35	4,56	4,56	4,56	4,56	4,56
3,00	5,20	2,81	3,03	3,25	3,46	3,68	3,90	4,11	4,33	4,55	4,76	4,98	5,20	5,20	5,20	5,20
3,25	5,86	3,15	3,38	3,61	3,83	4,06	4,28	4,51	4,73	4,96	5,18	5,41	5,63	5,86	5,86	5,86
3,50	6,55	3,51	3,74	3,98	4,21	4,44	4,68	4,91	5,14	5,38	5,61	5,85	6,08	6,31	6,55	6,55
3,75	7,26	3,87	4,12	4,36	4,60	4,84	5,08	5,33	5,57	5,81	6,05	6,29	6,54	6,78	7,02	7,26
4,00	8,00	4,25	4,50	4,75	5,00	5,25	5,50	5,75	6,00	6,25	6,50	6,75	7,00	7,25	7,50	7,75
4,25	8,76	4,64	4,90	5,15	5,41	5,67	5,93	6,18	6,44	6,70	6,96	7,22	7,47	7,73	7,99	8,25
4,50	9,55	5,04	5,30	5,57	5,83	6,10	6,36	6,63	6,89	7,16	7,42	7,69	7,95	8,22	8,49	8,75
4,75	10,35	5,45	5,72	5,99	6,27	6,54	6,81	7,08	7,36	7,63	7,90	8,17	8,45	8,72	8,99	9,26
5,00	11,18	5,87	6,15	6,43	6,71	6,99	7,27	7,55	7,83	8,11	8,39	8,66	8,94	9,22	9,50	9,78
5,25	12,03	6,30	6,59	6,87	7,16	7,45	7,73	8,02	8,31	8,59	8,88	9,17	9,45	9,74	10,02	10,31
5,50	12,90	6,74	7,04	7,33	7,62	7,92	8,21	8,50	8,79	9,09	9,38	9,67	9,97	10,26	10,55	10,85

a) The anchor spacing and the edge distance shall not be smaller than the minimum anchor spacing s_{min} and the minimum edge distance c_{min} .

Influence of embedment depth

Anchor size	Ø8	Ø10	Ø12	Ø14	Ø16	Ø20	Ø25
$f_{hef} = 0,05 \cdot (h_{ef} / d)^{1,68}$	2,39	2,00	2,07	1,98	1,58	1,82	1,79

Influence of edge distance ^{a)}

c/d	4	6	8	10	15	20	30	40
$f_c = (d / c)^{0,19}$	0,77	0,71	0,67	0,65	0,60	0,57	0,52	0,50

a) The edge distance shall not be smaller than the minimum edge distance c_{min} .

Combined tension and shear loading

For combined tension and shear loading see section "Anchor Design".

Precalculated values

Recommended loads can be calculated by dividing the design resistance by an overall partial safety factor for action $\gamma = 1,4$. The partial safety factors for action depend on the type of loading and shall be taken from national regulations.

Design resistance: concrete C 20/25 – $f_{ck,cube} = 25 \text{ N/mm}^2$

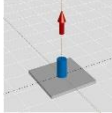
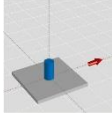
		Hilti technical data						
Anchor size		Ø8	Ø10	Ø12	Ø14	Ø16	Ø20	Ø25
Embedment depth $h_{ef,typ} =$ [mm]		80	90	110	125	125	170	210
Base material thickness $h_{min} =$ [mm]		110	120	142	161	165	220	274
	Tensile N_{Rd}: single anchor, no edge effects							
BSt 500 S	[kN]	7,2	10,1	14,3	18,5	22,7	30,2	37,8
	Shear V_{Rd}: single anchor, no edge effects, without lever arm							
BSt 500 S	[kN]	9,3	14,7	20,7	28,0	36,7	57,3	90,0

Design resistance: concrete C 20/25 – $f_{ck,cube} = 25 \text{ N/mm}^2$

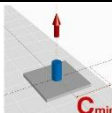
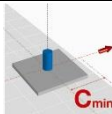
		Hilti technical data						
Anchor size		Ø8	Ø10	Ø12	Ø14	Ø16	Ø20	Ø25
Embedment depth $h_{ef,typ} =$ [mm]		80	90	110	125	125	170	210
Base material thickness $h_{min} =$ [mm]		110	120	142	161	165	220	274
Edge distance $c = c_{min} =$ [mm]		40	50	60	70	80	100	125
	Tensile N_{Rd}: single anchor, min. edge distance ($c = c_{min}$)							
BSt 500 S	[kN]	4,6	6,4	9,2	12,0	14,4	20,5	27,2
	Shear V_{Rd}: single anchor, min. edge distance ($c = c_{min}$), without lever arm							
BSt 500 S	[kN]	3,7	5,3	7,3	9,5	11,5	17,2	25,0

Design resistance: concrete C 20/25 – $f_{ck,cube} = 25 \text{ N/mm}^2$
(load values are valid for single anchor)

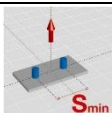
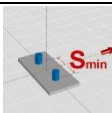
		Hilti technical data						
Anchor size		Ø8	Ø10	Ø12	Ø14	Ø16	Ø20	Ø25
Embedment depth $h_{ef,typ} =$ [mm]		80	90	110	125	125	170	210
Base material thickness $h_{min} =$ [mm]		110	120	142	161	165	220	274
Spacing $s = s_{min} =$ [mm]		40	50	60	70	80	100	125
	Tensile N_{Rd}: double anchor, no edge effects, min. spacing ($s = s_{min}$)							
BSt 500 S	[kN]	5,2	7,2	10,1	13,0	15,5	21,5	27,6
	Shear V_{Rd}: double anchor, no edge effects, min. spacing ($s = s_{min}$), without lever arm							
BSt 500 S	[kN]	9,3	14,7	20,7	28,0	36,7	50,6	63,4

Post-installed rebar connections

Basics, design and installation

Injection mortar systems for post-installed rebars

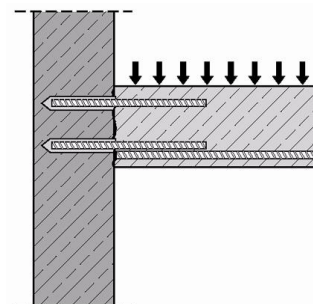

Basics, design and installation of post installed rebars

Content

1	Basics of post installed rebar connections	855
1.1	Definition of rebar.....	855
1.2	Advantages of post-installed rebar connections.....	855
1.3	Application examples.....	856
1.4	Anchorage and Splice.....	858
1.5	Bond of Cast-in Ribbed Bars	859
1.6	Specifics of Post-Installed Reinforcing Bars	860
2	Design of Post-Installed Reinforcement	861
2.1	Loads on Reinforcing Bars	861
2.2	Approval Based ETA/EC2 Design Method	862
2.2.1	Application Range	862
2.2.2	Design of Development and Overlap Length with Eurocode 2	863
2.2.3	Design Examples	864
	General information for design example	866
2.3	HIT-Rebar Design Method.....	867
2.3.1	Splitting Design	868
2.3.2	Strut and Tie Model for Frame Nodes	870
2.3.3	Design Examples	873
2.4	Load Case Fire	878
2.5	Fatigue of bonded-in reinforcement for joints	879
2.6	Seismic design of structural post-installed rebar	881
2.7	Corrosion behaviour.....	882
3	Design Programme PROFIS Rebar	883
4	References	886
5	Installation of Post-Installed Reinforcement	887
5.1	Joint to be roughened	887
5.2	Drilling	887
5.2.1	Standard Drilling.....	887
5.3	Hole cleaning	888
5.4	Injection and bar installation	888
5.5	Installation instruction	889
5.6	Mortar consumption estimation for post-installed rebars.....	889

1 Basics of post installed rebar connections

1.1 Definition of rebar

Reinforcement anchorages or splices that are fixed into already cured concrete by Hilti HIT injection adhesives in drilled holes are called “Post-installed rebar connections” as opposed to normal, so called “cast-in” reinforcement. Many connections of rebars installed for good detailing practice will not require specific design considerations. But post-installed rebars which become part of the structural system have to be designed as carefully as the entire structure. While European Technical Approvals prove that in basic load situations, post-installed rebars behave like cast-in bars, a number of differences needs to be considered in special design situations such as fire or load cases where hooks or bends would be required for cast-in anchorages. The following chapters are intended to give the necessary information to safely design and specify post-installed reinforcement connections.

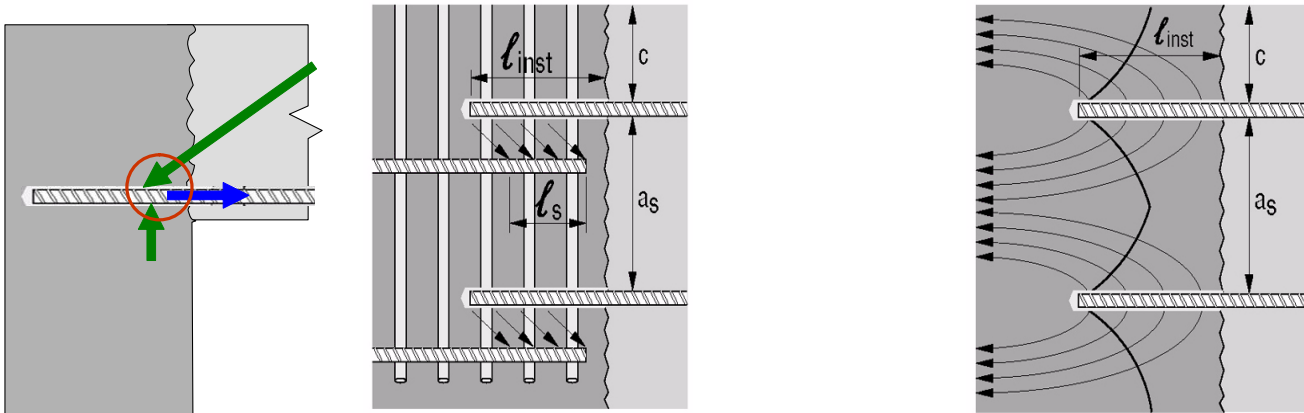

structural rebar situations: “anchorage node in equilibrium” and “splice”

anchor situation

This section of the Fastening Technology Manual deals with reinforcement connections designed according to structural reinforced concrete design principles. The task of structural rebars is to take tensile loads and since concrete failure is always brittle, reinforced concrete design assumes that concrete has no tensile strength. Therefore structural rebars can end / be anchored in only two situations:

- the bar is not needed anymore (the anchorage is a node in equilibrium without tensile stress in concrete)
- another bar takes over the tensile load (overlap splice)

Situations where the concrete needs to take up tensile load from the anchorage or where rebars are designed to carry shear loads should be considered as “rebar used as anchors” and designed according to anchor design principles as given e.g. in the guidelines of EOTA [3]

Unlike in anchor applications, reinforcement design is normally done for yielding of the steel in order to obtain ductile behaviour of the structure with a good serviceability. The deformations are rather small in correlation to the loads and the crack width limitation is around $w_k \sim 0.3\text{mm}$. This is an important factor when considering resistance to the environment, mainly corrosion of the reinforcement.

In case of correct design and installation the structure can be assumed as monolithic which allows us to look at the situation as if the concrete was poured in one. Due to the allowed high loads the required embedment depth can be up to $80d$ (diameter of rebar).

1.2 Advantages of post-installed rebar connections

With the use of the Hilti HIT injection systems it is possible to connect new reinforcement to existing structures with maximum confidence and flexibility.

- design flexibility
- reliable like cast in
- horizontal, vertical and overhead
- form work simplification
- defined load characteristics
- simple, high confidence application

1.3 Application examples

Post installed rebar connections are used in a wide range of applications, which vary from new construction projects, to structure upgrades and infrastructure requalifications.

Post-installed rebar connections in new construction projects

Diaphragm walls



Slab connections



Misplaced bars



Vertical/horizontal connections



Post-installed rebar connections in structure upgrades

Wall strengthening



New slab constructions



Joint strengthening



Cantilevers/balconies



Post-installed rebar connections in infrastructure requalifications
Slab widening



Structural upgrade



Slab strengthening



Sidewalk upgrade



1.4 Anchorage and Splice

Development Length

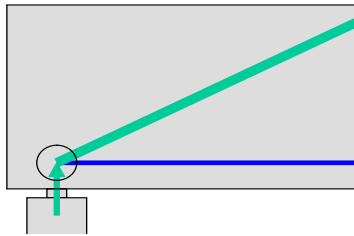

simple support

Reinforced concrete is often designed using strut and tie models. The forces are represented by trusses and the nodes of these trusses have to be in equilibrium like in the figure to the left: the concrete compression force (green line), the support force (green arrow) and the steel tensile force (blue). The model assumes that the reinforcing bar can provide its tensile force on the right side of the node while there is no steel stress at all on the left side, i.e. the bar is not needed any more on the left side of the node. Physically this is not possible, the strut and tie model is an idealization. The steel stress has to be developed on the left side of the node. This is operated by bond between steel and concrete. For the bar to be able to develop stress it needs to be extended on the left side of the node. This extension is called “development length” or “anchorage length”. The space on the

left side of the node shown in the figure above is not enough to allow a sufficient development of steel stress by bond. Possible approaches to solve this problem are shown in the figure below: either an extension of the concrete section over the support or a reduction of the development length with appropriate methods. Typical solutions are hooks, heads, welded transverse reinforcement or external anchorage.

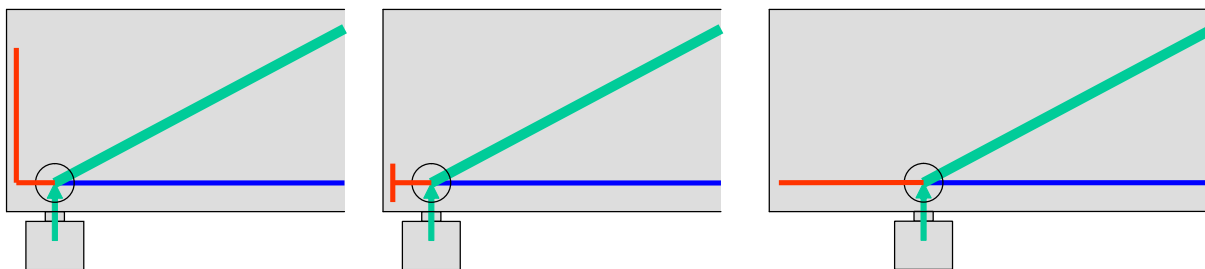

Typical solutions for anchoring of the reinforcement

Overlap Splices



In case that the equilibrium of a node cannot be established without using the tensile capacity of the concrete, the tensile force of a (ending) bar must be transmitted to other reinforcement bars. A common example is starter bars for columns or walls. Due to practical reasons foundations are often built with rebars much shorter than the final column height, sticking out of the concrete. The column reinforcement will later be spliced with these. The resulting tension load in the column reinforcement due to bending on the column will be transferred into the starter bars through an overlap splice.

Overlap splices

Forces are transmitted from one bar to another by lapping the bars. The detailing of laps between bars shall be such that:

- the transmission of the forces from one bar to the next is assured
- spalling of the concrete in the neighbourhood of the joints does not occur
- large cracks which affect the performance of the structure do not develop

1.5 Bond of Cast-in Ribbed Bars

General Behaviour

For ribbed bars, the load transfer in concrete is governed by the bearing of the ribs against the concrete. The reacting force within the concrete is assumed to be a compressive strut with an angle of 45°.

For higher bond stress values, the concentrated bearing forces in front of the ribs cause the formation of cone-shaped cracks starting at the crest of the ribs. The resulting concrete keys between the ribs transfer the bearing forces into the surrounding concrete, but the wedging action of the ribs remains limited. In this stage the displacement of the bar with respect to the concrete (slip) consists of bending of the keys and crushing of the concrete in front of the ribs.

The bearing forces, which are inclined with respect to the bar axis, can be decomposed into directions parallel and perpendicular to the bar axis. The sum of the parallel components equals the bond force, whereas the radial components induce circumferential tensile stresses in the surrounding concrete, which may result in longitudinal radial (splitting / spalling) cracks. Two failure modes can be considered:

Bond Failure

Bond failure is caused by pull-out of the bar if the confinement (concrete cover, transverse reinforcement) is sufficient to prevent splitting of the concrete cover. In that case the concrete keys are sheared off and a sliding plane around the bar is created. Thus, the force transfer mechanism changes from rib bearing to friction. The shear resistance of the keys can be considered as a criterion for this transition. It is attended by a considerable reduction of the bond stress. Under continued loading, the sliding surface is smoothed due to wear and compaction, which will result in a further decrease of the bond stress, similar to the case of plain bars.

Splitting failure:

Bond splitting failure is decisive if the radial cracks propagate through the entire cover. In that case the maximum bond stress follows from the maximum concrete confinement, which is reached when the radial cracks have penetrated the cover for about 70%. Further crack propagation results in a decrease of the confining stresses. At reaching the outer surface these stresses are strongly reduced, which results in a sudden drop of the bond stress.

Influence of spacing and cover on splitting and spalling of concrete

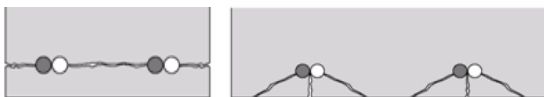

In most cases the reinforcement bars are placed close to the surface of the concrete member to achieve good crack distribution and economical bending capacity. For splices at wide spacing (normally in slabs, left part of figure left), the bearing capacity of the concrete depends only on the thickness of the concrete cover. At narrow spacing (normally in beams, right part of figure above) the bearing capacity depends on the spacing and on the thickness of the cover. In the design codes the reduction of bearing capacity of the cover is taken into account by means of multiplying factors for the splice length.

Load Transfer in Overlap Splices

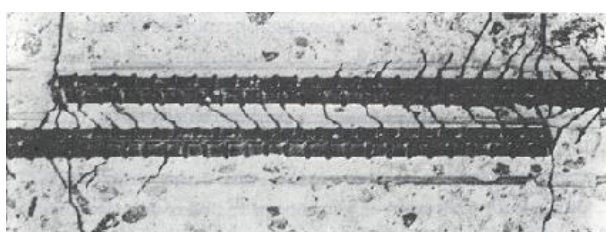

Load transfer at lap splices

The load transfer between bars is performed by means of compressive struts in the concrete, see figure left. A 45° truss model is assumed. The resulting perpendicular forces act as splitting forces. The splitting forces are normally taken up by the transverse reinforcement. Small splitting forces are attributed to the tensile capacity of the concrete. The amount of the transverse or tie reinforcement necessary is specified in the design codes.

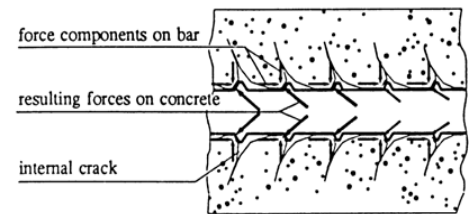

Load transfer from ribbed bars into

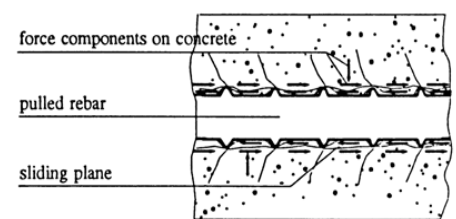

Bond failure of ribbed bars

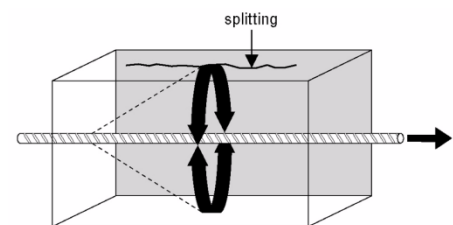

Splitting

1.6 Specifics of Post-Installed Reinforcing Bars

General Behaviour

The load transfer for post-installed bars is similar to cast in bars if the stiffness of the overall load transfer mechanism is similar to the cast-in system. The efficiency depends on the strength of the adhesive mortar against the concentrated load near the ribs and on the capacity of load transfer at the interface of the drilled hole.

In many cases the bond values of post-installed bars are higher compared to cast in bars due to better performance of the adhesive mortar. But for small edge distance and/or narrow spacing, splitting or spalling forces become decisive due to the low tensile capacity of the concrete.

Post-Installed Reinforcement Approvals

There are European Technical Approvals for post-installed rebar connections. Systems getting such approvals have to be assessed according to the EOTA technical guideline TR023 [2] (available in the EOTA website). Requirements for a positive assessment are an installation system providing high installation quality for deep holes and an adhesive fulfilling the test requirements of the guideline TR023. Obtaining the approval is basically the proof that the post-installed rebars work at least as well as cast-in rebars (with respect to bond strength and displacement); consequently, the design of the rebar anchorage is performed according to structural concrete design codes, in the case of Europe this is Eurocode 2 [1].

High Quality Adhesives Required

Assessment criteria

EOTA TR023 [2] specifies a number of tests in order to qualify products for post-installed rebar applications. These are the performance areas checked by the tests:

1. bond strength in different strengths of concrete
2. substandard hole cleaning
3. Wet concrete
4. Sustained load and temperature influence
5. Freeze-thaw conditions
6. Installation directions
7. Maximum embedment depth
8. Avoidance of air bubbles during injection
9. Durability (corrosion, chemical attack)

Approvals with or without exceptions

If an adhesive fulfills all assessment criteria of EOTA TR023, rebar connections carried out with this adhesive can be designed with the bond strength and minimum anchorage length according to Eurocode 2 [1] as outlined in section 2.2 of this document.

Adhesives which do not fully comply with all assessment criteria can still obtain an “approval with exceptions”.

- If the bond strength obtained in tests does not fulfil the specified requirements, then bond strengths lower than those given by Eurocode 2 shall be applied. These values are given in the respective ETA.
- If it cannot be shown that the bond strength of rebars post-installed with a selected product and cast-in rebars in cracked concrete ($w=0.3\text{mm}$) is similar, then the minimum anchorage length $\ell_{b,min}$ and the minimum overlap length $\ell_{o,min}$ shall be increased by a factor 1.5.

2 Design of Post-Installed Reinforcement

There are two design methods which are supported by Hilti:

1. Based on the approval (ETA) for the mortar system qualified according to EOTA TR023 [2] which allows to use the accepted structural code Eurocode 2 EN 1992-1-1:2011 [1], chapters 8.4: "anchorage of longitudinal reinforcement" and 8.7 "Laps and mechanical couplers" taking into account some adhesive specific parameters. This method is called

"ETA/EC2 Design Method"

paragraph 2.2 gives an overview of the design approach and design examples, technical data from the rebar approvals can be found in section 6.

2. For applications which are not covered by "ETA/EC2 Design Method", the design approach of Eurocode 2 has been extended on the basis of extensive internal as well as external research [6 - 8] as well as assessments [9]. This method is called

"Hit Rebar Design Method"

which offers an extended range of applications (please see section 2.3 for an overview of the design approach as well as design examples).

2.1 Loads on Reinforcing Bars

Strut and Tie Model

Strut-and-tie models are used to calculate the load path in reinforced concrete members. Where a non-linear strain distribution exists (e.g. supports) strut-and-tie models may be used {Clause 6.5.1(1), EC2: EN 1992-1-1:2011}.

Strut-and-tie models consist of struts representing compressive stress fields, of ties representing the reinforcement and of the connecting nodes. The forces in the elements of a strut-and-tie model should be determined by maintaining the equilibrium with the applied loads in ultimate limit state. The ties of a strut-and-tie model should coincide in position and direction with the corresponding reinforcement {Clause 5.6.4, EC2: EN 1992-1-1:2011 Analysis with strut and tie models}.

In modern concrete design codes the strut angle θ can be selected within certain limits, roughly between 30° and 60° . Many modern concrete design codes show a figure similar to the following:

The equilibrium equations in horizontal direction gives the force in the reinforcement:

$$F_{sl} = \frac{M_y}{z} + \frac{N_x}{2} + \frac{V_z \cdot \cot \theta}{2}$$

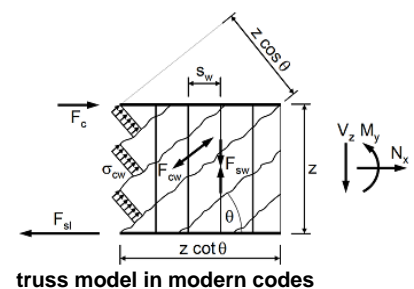
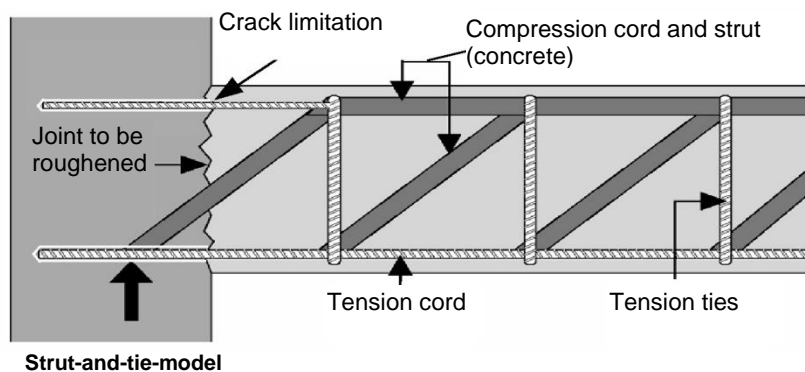

2.2 Approval Based ETA/EC2 Design Method

2.2.1 Application Range

The principle that rebars are anchored “where they are not needed any more” (anchorage) or where the force is taken over by another bar (splice) and the fact that only straight rebars can be post-installed lead to the application range shown by the figures taken from EOTA TR023 [2]:

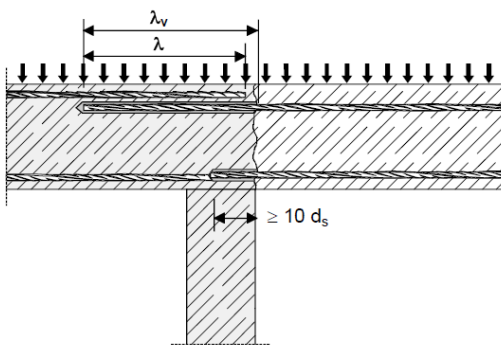

Figure 1.1: Overlap joint for rebar connections of slabs and beams

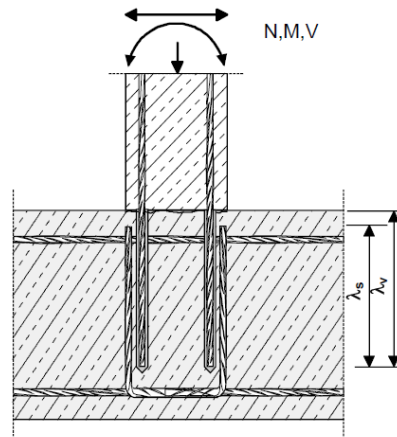

Figure 1.2: Overlap joint at a foundation of a column or wall where the rebars are stressed in tension

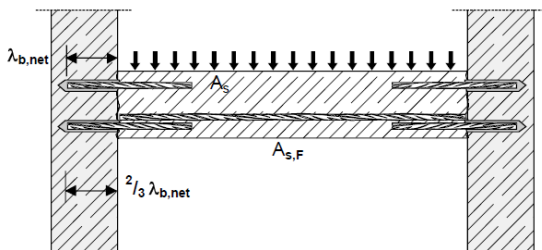

Figure 1.3: End anchoring of slabs or beams, designed as simply supported

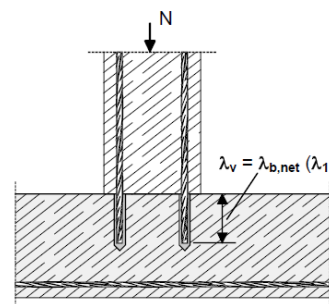

Figure 1.4: Rebar connection for components stressed primarily in compression. The rebars are stressed in compression

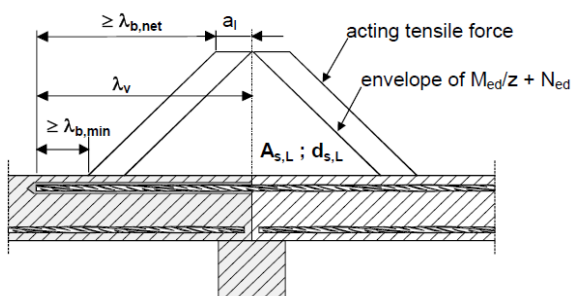

Figure 1.5: Anchoring of reinforcement to cover the line of acting tensile force

Note to Figure 1.1 to 1.5:

In the Figures no transverse reinforcement is plotted, the transverse reinforcement as required by EC 2 shall be present.

The shear transfer between old and new concrete shall be designed according to EC 2.

Application range according to EOTA TR023

All other applications lead to tensile stress in the concrete. Therefore, the principle “works like cast-in” would not be true any more. Such cases must be considered with specific models exceeding the approval based approach to post-installed rebar connections.

2.2.2 Design of Development and Overlap Length with Eurocode 2

The following reflect the design relevant sections from EOTA TR023, chapter 4 “Assumptions under which the fitness of use is to be assessed” and from the specific European Technical Approvals:

Design method for post-installed rebar connections

- The post-installed rebar connections assessed according to this Technical Report shall be designed as straight cast-in-place rebars according to EC2 using the values of the design bond resistance f_{bd} for deformed bars as given in the relevant approval.
- Overlap joint for rebars: For calculation of the effective embedment depth of overlap joints the concrete cover at end-face of the post-installed rebar c_1 shall be considered:

$$l_v \geq l_0 + c_1$$

with: l_0 = required lap length

c_1 = concrete cover at end-face of bonded-in rebar

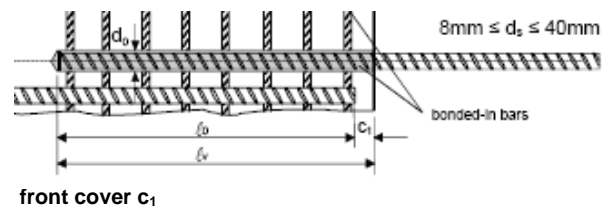

- The definition of the bond region in EC2 is valid also for post-installed rebars.
- The conditions in EC2 concerning detailing (e.g. concrete cover in respect to bond and corrosion resistance, bar spacing, transverse reinforcement) shall be complied with.
- The transfer of shear forces between new and old concrete shall be designed according to EC2 [1].

Additional provisions

- To prevent damage of the concrete during drilling the following requirements have to be met:

- Minimum concrete cover:

$$c_{min} = 30 + 0,06 l_v \geq 2d_s \text{ (mm) for hammer drilled holes}$$

$$c_{min} = 50 + 0,08 l_v \geq 2d_s \text{ (mm) for compressed air drilled holes}$$

The factors 0,06 and 0,08 should take into account the possible deviations during the drilling process. This value might be smaller if special drilling aid devices are used.

Furthermore the minimum concrete cover given in clause 4.4.1.2, EC2: EN 1992-1-1: 2004 shall be observed.

- Minimum clear spacing between two post-installed bars $a = 40 \text{ mm} \geq 4d_s$

- To account for potentially different behaviour of post-installed and cast-in-place rebars in cracked concrete,
 - in general, the minimum lengths $l_{b,min}$ and $l_{o,min}$ given in the EC 2 for anchorages and overlap splices shall be increased by a factor of 1.5. This increase may be neglected under certain conditions. The relevant approval states under which conditions the factor can be neglected for a specific adhesive.

Preparation of the joints

- The surface of the joint between new and existing concrete should be prepared (roughing, keying) according to the envisaged intended use according to EC2.
- In case of a connection being made between new and existing concrete where the surface layer of the existing concrete is carbonated, the layer should be removed in the area of the new reinforcing bar (with a diameter $d_s+60\text{mm}$) prior to the installation of the new bar.

Transverse reinforcement

The requirements of transverse reinforcement in the area of the post-installed rebar connection shall comply with clause 8.7.4, EC2: EN 1992-1-1:2011.

2.2.3 Design Examples

a) End support of slab, simply supported

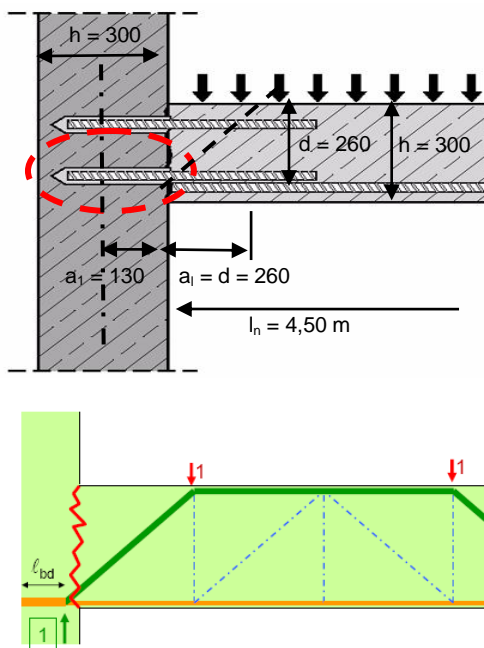

slab: $l_n = 4,50\text{m}$, $Q_k = 20\text{ kN/m}^2$, $h = 300\text{ mm}$, $d = 260\text{ mm}$

wall: $h = 300\text{ mm}$

Concrete strength class: C20/25, dry concrete

Reinforcement: $f_{yk} = 500\text{ N/mm}^2$, $\gamma_s = 1.15$

Loads: $G_k = 25\text{ kN/m}^3 \cdot h = 7.5\text{ kN/m}^2$;
 $S_d = (1.50 \cdot Q_d + 1.35 \cdot G_k) = 40.1\text{ kN/m}^2$

Structural analysis (design forces):

$$M_{Ed} = S_d \cdot l_n^2 / 8 = 102\text{ kNm/m}$$

$$V_{Ed} = S_d \cdot l_n / 2 = 90.3\text{ kN/m}$$

Bottom reinforcement required at mid span:

$$A_{s,rqd,m} = (M_{sd} \cdot \gamma_s) / (0.9 \cdot d \cdot f_{yk}) = 998\text{ mm}^2/\text{m}$$

reinforcement provided at mid span: $\varnothing 16$, $s = 200\text{ mm}$

$$A_{s,prov,m} = 1005\text{ mm}^2/\text{m}$$

Bottom reinforcement at support:

Tension force to be anchored: $F_E = |V_{Ed}| \cdot a_1 / (0.9d) = 100\text{ kN/m}$ {Clause 9.2.1.4(2), EC2: EN 1992-1-1:2004}

Steel area required: $A_{s,rqd} = F_E \cdot \gamma_s / f_{yk} = 231\text{ mm}^2/\text{m}$

Minimum reinforcement to be anchored at support:

$A_{s,min} = k_c \cdot k \cdot f_{ct,eff} \cdot A_s / \sigma_s = 0,4 \cdot 1 \cdot 2,2 \cdot 150 \cdot 1000 / 500 = 264\text{ mm}^2/\text{m}$ {Clause 7.3.2(2), EC2: EN 1992-1-1:2011}

$A_{s,min} = 0,50 \cdot 988 = 499\text{ mm}^2/\text{m}$ {Clause 9.3.1.2(1), EC2: EN 1992-1-1:2011}

$A_{s,min} = 0,25 \cdot 1010 = 251\text{ mm}^2/\text{m}$ {Clause 9.2.1.4(1), EC2: EN 1992-1-1:2011}

Decisive is $499\text{ mm}^2/\text{m} \Rightarrow$ reinforcement provided: $\varnothing 12$, $s = 200\text{ mm} \Rightarrow A_{s,prov} = 565\text{ mm}^2/\text{m}$;

Installation by wet diamond core drilling: Hilti HIT-RE 500 is suitable adhesive (see Tech data, sect. 2.2.3)

Basic anchorage length {EC2: EN 1992-1-1:2004, section 8.4.3}:

$$l_{b,rqd} = (d_s / 4) \times (\sigma_{sd} / f_{bd})$$

with: $d_s =$ diameter of the rebar = 12 mm

$\sigma_{sd} =$ calculated design stress of the rebar = $(A_{s,rqd} / A_{s,prov}) \cdot (f_{yk} / \gamma_s) = (231 / 565) \cdot (500 / 1,15) = 177\text{ N/mm}^2$

$f_{bd} =$ design value of bond strength according to corresponding ETA (= 2,3 N/mm²)

$$l_{b,rqd} = (12 / 4) \times (177 / 2.3) = 231\text{ mm}$$

Design anchorage length {EC2: EN 1992-1-1:2011, section 8.4.4}:

$$l_{bd} = \alpha_1 \alpha_2 \alpha_3 \alpha_4 \alpha_5 l_{b,rqd} \geq l_{b,min}$$

with: $l_{b,rqd}$ as above

$\alpha_1 = 1,0$ for straight bars

$\alpha_2 = 1 - 0,15(c_d - \varnothing) / \varnothing$ ($0,7 \leq \alpha_2 \leq 1,0$)

α_2 is for the effect of concrete cover, in this case half the clear spacing: $c_d = (200 - 12) / 2 = 94\text{ mm}$

$\alpha_2 = 0,7$

Straight bars, $c_d = \min(a/2, c_1, c)$

$\alpha_3 = 1,0$ because of no transverse reinforcement

$\alpha_4 = 1,0$ because of no welded transverse reinforcement

$\alpha_5 = 1,0$ influence of transverse pressure is neglected in this example

$$\ell_{bd} = 0,7 \cdot 231 = 162 \text{ mm}$$

minimum anchorage length {Clause 8.4.4(1), EC2: EN 1992-1-1:2011}:

$$\ell_{b,min} = \max \{0,3\ell_{b,rqd}; 10\phi; 100\text{mm}\} = 120 \text{ mm}$$

ℓ_{bd} controls \rightarrow drill hole length $l_{ef} = 162 \text{ mm}$

Top reinforcement at support:

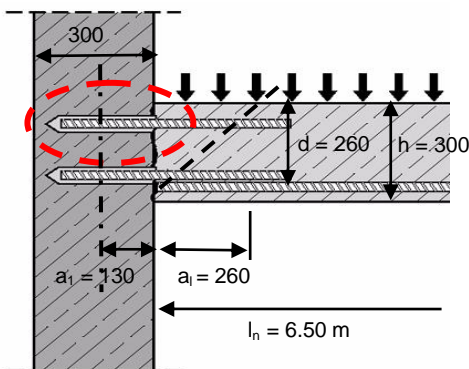

Minimum reinforcement:

- 25% of bottom steel required at mid-span
{Clause 9.3.1.2(2), EC2: EN 1992-1-1:2004}
 $A_{s,req} = 0,25 \cdot 988 = 247 \text{ mm}^2/\text{m}$
- requirement for crack limitation :
{Clause 7.3.2(2), EC2: EN 1992-1-1:2004}
 $A_{s,min} = 0,4 \cdot 1 \cdot 2,2 \cdot 150 \cdot 1000 / 435 = 303 \text{ mm}^2/\text{m}$

Decisive is $303 \text{ mm}^2/\text{m}$

\Rightarrow reinforcement provided: $\phi 10$, $s = 200 \text{ mm}$; $A_{s,prov} = 393 \text{ mm}^2/\text{m}$

Design stress in bar: $\sigma_{sd} = f_{yd} \cdot A_{s,min} / A_{s,prov} = 335 \text{ N/mm}^2$

$$\ell_{b,rqd} = (d_s / 4) \times (\sigma_{sd} / f_{bd}) = (10 / 4) \times (335 / 2.3) = 364 \text{ mm}$$

$$\ell_{bd} = \alpha_1 \alpha_2 \alpha_3 \alpha_4 \alpha_5 \ell_{b,rqd} = 0,7 \cdot 364 = 255 \text{ mm}$$

$$\ell_{b,min} = \max \{0,3\ell_{b,rqd}; 10\phi; 100\text{mm}\} = 120 \text{ mm}$$

Therefore, drill hole length $l_{ef} = 255 \text{ mm}$

If wet diamond core drilling is used {Clause 8.4.4(1), EC2: EN 1992-1-1:2011}:

$$\ell_{b,min} = \max \{0,3\ell_{b,rqd}; 10\phi; 100\text{mm}\} \cdot 1.5 = 180 \text{ mm} \quad (\text{as wet diamond core drilling is used, the minimum values according do EC2 have to be multiplied by 1.5, see tech data})$$

\rightarrow in this case the minimum length will control, drill hole length for the lower layer will be $l_{ef,diamond,lower} = 180 \text{ mm}$ and will remain for the upper layer $l_{ef,diamond,upper} = 255 \text{ mm}$.

b) splice on support

General information for design example

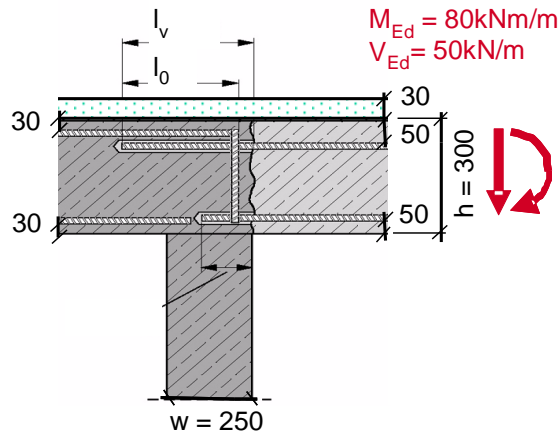

- Bending moment: $M_{Ed}=80$ kNm/m; shear: $V_{Ed} = 50$ kN/m
- slab: cover cast-in bars $c_c = 30$ mm (top, bottom); cover new bars: $c_n = 50$ mm $h = 300$ mm;
- top reinforcement (new and existing): $\phi 16$, $s = 200$ mm; $A_{s,prov} = 1005$ mm²/m; cover to face $c_1 = 30$ mm
- bottom reinforcement: $\phi 10$, $s=200$ mm; $A_{s,prov}=393$ mm²/m
- Concrete strength class: C25/30
- Properties of reinforcement: $f_{yk} = 500$ N/mm²
- Fire resistance: R60 (1 hour),
Light weight plaster for fire protection: $t_p=30$ mm;
maximum steel stress in fire $\sigma_{Rd,fi} = 322$ N/mm²
- Hilti HIT-RE 500

Cast-in reinforcement top

$$l_{0,ci} = \alpha_1 \alpha_2 \alpha_3 \alpha_5 \alpha_6 l_{b,rqd,ci} \geq l_{0,min}$$

$\eta_1 = (d - \phi/2 > 250\text{mm})$	0.7	poor bond condition
$Z_{ci} =$	239 mm	(from static calculation)
$A_{s,req} = (M_{Ed}/z) \cdot (\gamma_s/f_{yk}) = (80/0.239) \cdot (1.15/0.5) =$	770 mm ² /m	
$\sigma_{sd} = (A_{s,rqd} / A_{s,prov}) \cdot (f_{yk}/\gamma_s) = (770 / 1005) \cdot (500 / 1.15) =$	333 N/mm ²	
$f_{bd} = 2.25 \cdot \eta_1 \cdot 0.7 \cdot 0.3 \cdot f_{ck}^{2/3} / \gamma_c = 2.25 \cdot 0.7 \cdot 0.7 \cdot 0.3 \cdot 25^{2/3} / 1.5 =$	1.89 N/mm ²	(ETA 08/0105)

$$l_{b,rqd,pi} = (\phi / 4) \cdot (\sigma_{sd} / f_{bd}) = (16 / 4) \cdot (333 / 1.89) = 705 \text{ mm}$$

$\alpha_1 =$	0.7	hooked end of cast-in bars
$\alpha_2 = (1 - 0.15(c_d - \phi) / \phi \geq 0.7) = 1 - 0.15(30 - 16) / 16 =$	0.87	
$\alpha_3 =$	1.0	no transverse reinforcement
$\alpha_5 =$	1.0	no transverse pressure
$\alpha_6 =$	1.5	splice factor

$$l_{0,min} = \max\{0.3 \cdot 1.5 \cdot 705; 15 \cdot 16; 200\} = 317 \text{ mm}$$

$$l_{0,ci} = 0.70 \cdot 0.87 \cdot 1.5 \cdot 705 = 643 \text{ mm}$$

Post-installed reinforcement top

The required design lap length l_0 shall be determined in accordance with EC2: EN 1992-1-1:2004, section 8.7.3:

$$l_{0,pi} = \alpha_1 \alpha_2 \alpha_3 \alpha_5 \alpha_6 l_{b,rqd,pi} \geq l_{0,min}$$

$d = h - c_n - \phi/2 = 300 - 50 - 16/2 =$	242 mm	
$\eta_1 = (d - \phi/2 < 250\text{mm})$	1.0	good bond condition
$Z =$	228 mm	(from static calculation)
$A_{s,req} = (M_{Ed}/z) \cdot (\gamma_s/f_{yk}) = (80/0.228) \cdot (1.15/0.5) =$	807 mm ² /m	
$\sigma_{sd} = (A_{s,rqd} / A_{s,prov}) \cdot (f_{yk}/\gamma_s) = (807 / 1005) \cdot (500 / 1.15) =$	349 N/mm ²	
$f_{bd} = \text{design value of bond strength according to 2.2.3} =$	2.7 N/mm ²	(ETA 08/0105)

$$l_{b,rqd,pi} = (\phi / 4) \cdot (\sigma_{sd} / f_{bd}) = (16 / 4) \cdot (349 / 2.7) = 516 \text{ mm}$$

$\alpha_1 =$	1.0	for straight bars
--------------	-----	-------------------

$\alpha_2 = (1 - 0.15(c_d - \phi)/\phi \geq 0.7) = 1 - 0.15(50 - 16)/16 =$	0.7	
$\alpha_3 =$	1.0	no transverse reinforcement
$\alpha_5 =$	1.0	no transverse pressure
$\alpha_6 =$	1.5	splice factor
$l_{0,min} = \max\{0.3 \cdot 1.5 \cdot 515; 15 \cdot 16; 200\} =$	240 mm	
$l_{0,pi} = 0.7 \cdot 1.5 \cdot 530 =$	542 mm	

Fire resistance post-installed reinforcement top:

$\gamma_L =$	1.4	assumed safety factor loads
$\sigma_{sd,fi} = \sigma_{sd}/\gamma_L = 358/1.4 =$	249 N/mm ²	$< \sigma_{Rd,fi} \rightarrow ok$
$c_{fi} = c_n + t_p = 30 + 50 =$	80 mm	cover effective against fire
$f_{bd,fi} = (\text{sect. 2.4.1, table fire parallel})$	1.4 N/mm ²	(DIBt Z-21.8-1790)
$l_{0,pi,fi} = (\phi/4) \cdot (\sigma_{sd,fi}/f_{bd,fi}) = (16/4) \cdot (249/1.4) =$	711 mm	

Embedment depth for post-installed rebars top:

$e = [(s/2)^2 + (c_n - c_c)^2]^{0.5} - \phi = [100^2 + (50 - 30)^2]^{0.5} - 16 =$	86 mm	clear spacing between spliced bars
$\Delta l_0 = e - 4\phi = 86 - 4 \cdot 16 =$	22 mm	
$l_0 = \max(l_{0,pi}; l_{0,pi,fi}; l_{0,ci}; l_{0,min}) + \Delta l_0 = 711 + 22 =$	733 mm	
$c_f =$	30 mm	
$w/2 =$	125 mm	
$l_v = l_0 + \max(w/2; c_f) = 733 + 125 =$	858 mm	

Embedment depth for post-installed rebars bottom:

Concrete in compression, no force on bars → anchorage with minimum embedment length.

$f_{min} =$	1.0 mm	(ETA 08/0105)
$l_{b,min} = f_{min} \cdot \max(10\phi; 100\text{mm}) = 1.0 \cdot \max(10 \cdot 10; 100) =$	100 mm	
$w/2 =$	125 mm	
$l_v = l_{b,min} + w/2 = 100 + 125 =$	225 mm	

2.3 HIT-Rebar Design Method

While the EC2/ETA design method is of direct and simple use, it has two main drawbacks

- The connection of simply supported slabs to walls is only possible if the wall is thick enough to accommodate the anchorage length. As reductions of the anchorage length with hooks or welded transverse reinforcement cannot be made with post-installed reinforcement, it often occurs that the wall is too small. However, if the confinement of the concrete is large enough, it is actually possible to use the full

bond strength of the adhesive rather than the bond strength given by Eurocode 2 [1]. The so-called “splitting design” allows to design for the full strength of the adhesive [5, 9].

- According to traditional reinforced concrete principles, moment resisting frame node connections required bent connection bars. In this logic, they can therefore not be made with straight post-installed rebar connections. The frame node model is a proposed strut and tie model to design moment resisting frame node connections with straight connection bars [6, 7].

2.3.1 Splitting Design

The factor α_2 of Eurocode 2 [1] gives an explicit consideration for splitting and spalling as a function of concrete cover and bar spacing. European Technical Approvals recommend the same procedure for post-installed rebar connections:

$$l_{bd, spl} = \frac{\phi}{4} \cdot \frac{\sigma_{sd}}{f_{bd}} \cdot \alpha_2$$

f_{bd} according to technical data (ETA's for post – installed anchors)

$$\alpha_2 = 1 - 0.15 \cdot \frac{c_d - \phi}{\phi}$$

$$c_d = \min(c_x; c_y; s/2)$$
(1)

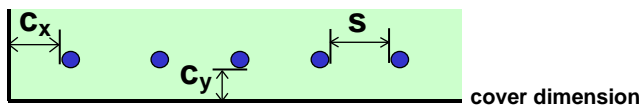

This function is adapted and extended for post-installed reinforcement for the HIT-Rebar design concept: Eurocode 2 limits the α_2 value to $\alpha_2 \geq 0.7$. This can be interpreted as follows: as long as α_2 exceeds 0.7, spalling of the concrete cover or splitting between bars will be the controlling mode of failure. If α_2 is less than 0.7, corresponding to cover dimensions of $c_d/\phi > 3$, the cover is large enough so that splitting cannot occur any more and pullout will control. Assuming an infinitely strong adhesive, there would be no such lower limit on α_2 and the bond stress, at which splitting occurs can be expressed as:

$$f_{bd, spl1} = \frac{f_{bd}}{1 - 0.15 \cdot \frac{c_d - \phi}{\phi}}$$

For cover dimensions exceeding the range of Eurocode 2, i.e. for $c_d/\phi > 3$ (bonded-in bars only), an adapted factor α_2' is used to create a linear extension of the bond strength function:

$$\alpha_2' = \frac{1}{\frac{1}{0.7} + \delta \cdot \frac{c_d - 3 \cdot \phi}{\phi}}$$

$$f_{bd, spl2} = \frac{f_{bd}}{\max[\alpha_2'; 0.25]}$$

where δ is a factor defining the growth of the linear function for $f_{bd, spl, 2}$; it is calibrated on the basis of tests. In order to avoid unreasonably low values of α_2' , its value is limited to $\alpha_2' \geq 0.25$

Below is a typical design bond stress f_{bd} curve as a function of the minimum edge distance/spacing distance, c_d is shown for a concrete class C20/25 and for a rebar with a diameter of not more than 32mm. In this figure the equivalent design bond stresses according to EC 2 and resulting from the above described definition of α_2 and α_2' are plotted. The design bond strength is defined by an inclined line and it increases with larger values of c_d . The diagram also shows the characteristic value of the bond strength ($f_{bd} \cdot \gamma_c$ where $\gamma_c = 1.5$).

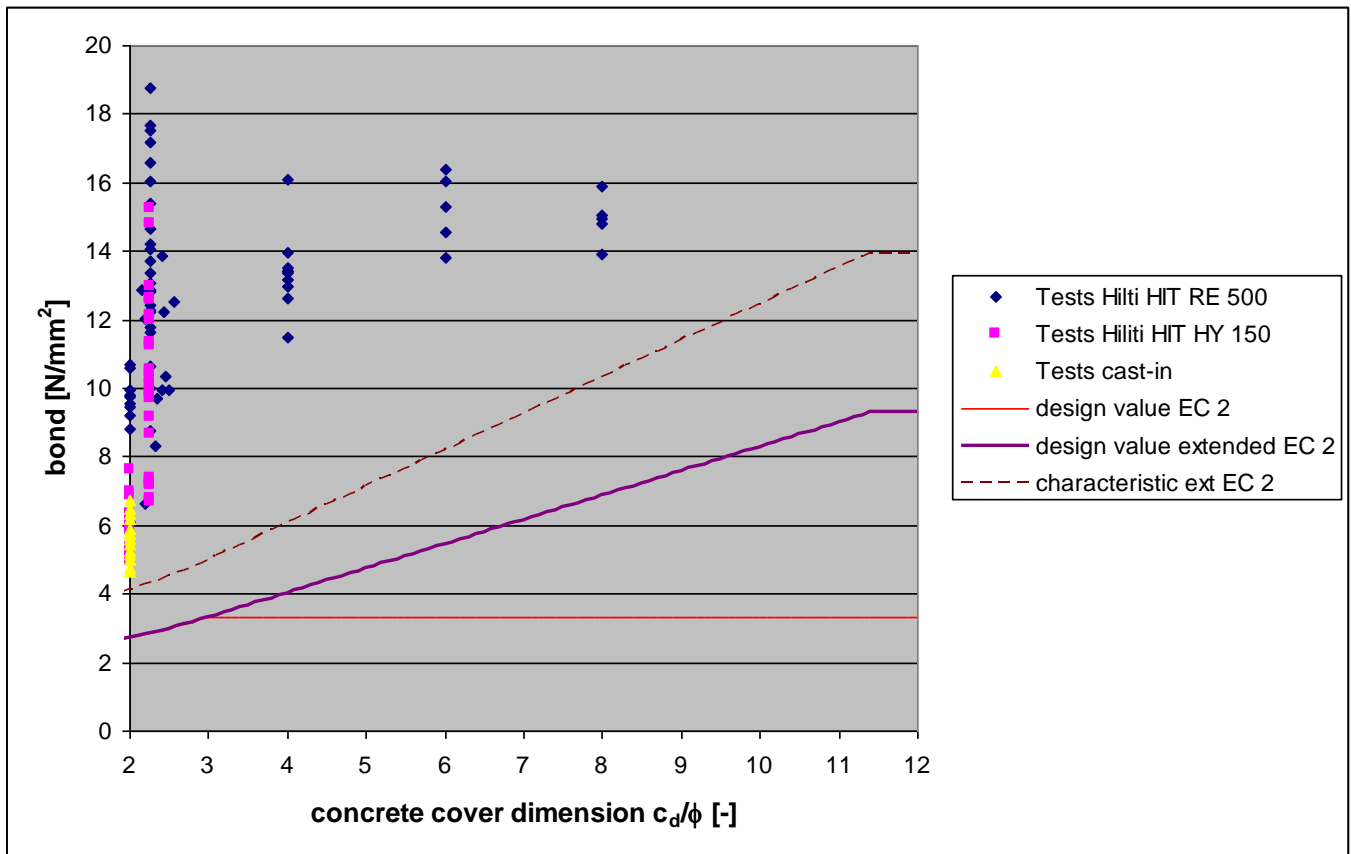

The increase in the design bond stress is limited by the maximum pull-out bond stress, which is a value given by the standards in the case of a cast-in reinforcement. For post-installed reinforcement, the maximum design bond stress is a function of the bonding agent and not necessarily equals that of cast-in bars; it will be taken from the relevant anchor approval. Thus, the limitation for bond failure in the code has been replaced by the specific design bond stress of the bonding agent for the specific application conditions and the splitting function has been adapted according to the tests.

2.3.2 Strut and Tie Model for Frame Nodes

If frame nodes (or moment resisting connections in general) are designed with cast-in reinforcement, they usually require bent bars according to the standard reinforced concrete design rules. Anchoring the reinforcement of moment resisting connections with straight bars would, at least at first sight, result in concrete that is under tension, and therefore in a possible concrete cone failure. As this failure mode is brittle, such an anchorage is not allowed by the standard concrete design rules. In cooperation with the Technical University of Munich, Hilti performed a research programme in order to provide a strut-and-tie model for frame nodes with straight connection bars [6, 7]. The main differences to the standard cast-in solution are that the compression strut is anchored in the bonding area of the straight bar rather than in the bend of the bar and that, therefore, first the inner lever arm inside the node is reduced and second, splitting forces in the transition zone between D- and B-region must be considered.

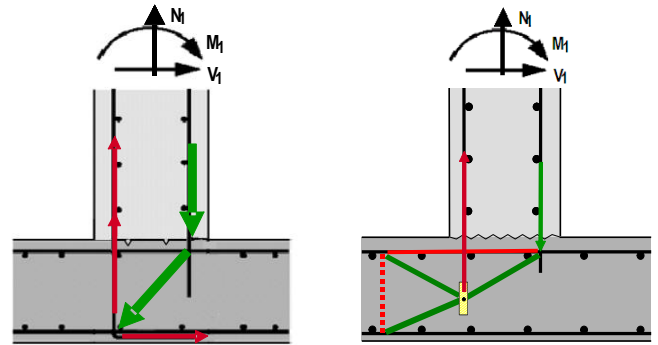

Global Equilibrium of the Node

In order to check the struts and ties inside the node, the reactions $N_2, V_2, M_2, N_3, V_3, M_3$ at the other ends of the node need to be defined. Normally, they result from the structural analysis outside the node region and will be determined by the designer in charge.

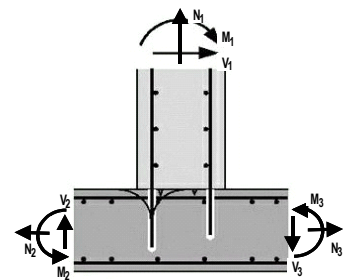

Global equilibrium of the node

Tension in connecting bars

The loading of the wall in the figures results in a tensile force in the reinforcement on the left hand side and in a compression force on the right hand side. Initial tests and computer simulations led to the consideration that the straight bar has a tendency to push a concrete cone against the interface with the wall. Thus the compressive stress in the interface is not concentrated on the outside of the wall, but distributed over a large part of the interface, which leads to a reduced lever arm in the wall section. The recommended reduction factor is 0.85 for opening moments and 1.0 for closing moments.

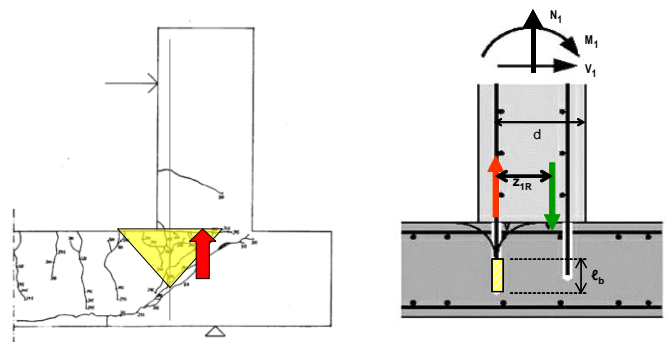

Anchorage length

While the equilibrium inside of frame nodes with cast-in hooked bars can be modeled with the compression strut continuing from the vertical compression force and anchored in the bend at the level of the lower reinforcement, straight bars are anchored by bond stresses at a level above the lower reinforcement.

As bending cracks are expected to occur along the bar from the top of the base concrete, the anchorage zone is developing from the lower end of the bar and its length ℓ_b is that required to develop the steel stress calculated from the section forces M_1, N_1 and V_1 .

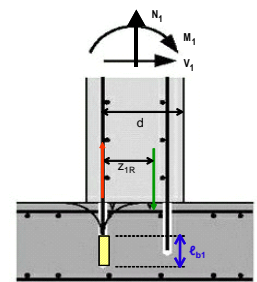

$$\ell_b = \frac{\sigma_{sd} \cdot \phi}{4 \cdot f_{bd}}$$

with σ_{sd} design steel stress in the connection bars [MPa]
 ϕ diameter of the vertical bar [mm]
 f_{bd} design bond strength of cast-in bar to concrete or of the adhesive mortar [MPa]

Installation length

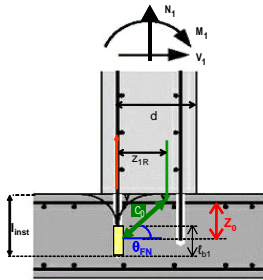

The strut-and-tie model requires that the angle θ between the inclined compression strut C_0 and the horizontal direction is 30° to 60° . For low drill hole lengths the resulting strut angle will be less than 30° . In such situations the design will not work as tests have shown. Also in order to remain as close as possible to the original solution with the bent bar, it is recommended to drill the holes as deep as possible in order to achieve a large strut angle θ_{FN} .

Note that PROFIS Rebar will preferably propose the installation length such that the strut angle θ_{FN} is 60° . In cases where the existing section is too thin for this, it will propose the maximum possible embedment depth which is defined for bonded anchors in ETAG 001,

part 5, section 2.2.2 as

$$\ell_{inst,max} = h_{member} - \max(2 \cdot d_0; 30\text{mm})$$

with $\ell_{inst,max}$ maximum possible installation length [mm]
 h_{member} thickness of the existing concrete member [mm]
 d_0 diameter of the drilled hole [mm]

Tension in Existing Reinforcement

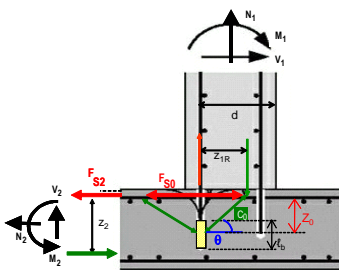

For a drilled hole depth ℓ_{inst} and a concrete cover of the upper reinforcement to the center of the bars of c_s , the lever arm inside z_0 the node is:

$$z_0 = \ell_{inst} - \frac{\ell_b}{2} - c_s$$

The lever arm inside the node z_0 is smaller than the lever arm of the slab z_2 . The tension in the upper slab reinforcement in the node region, F_{s0} , is higher than the tension calculated for the slab with z_2 ; the tensile resistance of the existing upper reinforcement $A_{s0,prov}$ must therefore be checked separately as follows:

$$F_{s2} = M_2/z_2 + N_2/2 \quad (\text{tension in existing reinforcement outside node area})$$

$$H_{s2} = \left(M_1 + (V_2 + V_3) \cdot \frac{z_1}{2} \right) \cdot \left(\frac{1}{z_0} - \frac{1}{z_2} \right) + V_1 \cdot \left(\frac{z_1}{z_0} - 1 \right) \quad (\text{additional tension in node due to reduced lever arm})$$

$$F_{s0} = F_{s2} + H_{s2} \quad (\text{steel tension in node area})$$

$$A_{s0,rqd} = F_{s0}/(f_{yk}/\gamma_s) \quad (\text{steel area required in existing part for forces from new part})$$

If $A_{s0,prov} \geq A_{s0,rqd}$ the reinforcement of the existing part is sufficient, provided that the forces from the new part are the only load on the section. This is the analysis obtainable from PROFIS Rebar.

As mentioned further above, a more sophisticated check needs to be made if there are also other loads in the system. Basically it would mean replacing F_{s2} as evaluated by under "global equilibrium" above by that evaluated in the complete static design.

The shallower the embedment of the post-installed vertical bar is, the more the moment resistance of the slab in the node region is reduced compared to a node with hooked bar. For this reason, it is also recommended to provide deep embedment of the connecting bars rather than trying to optimize mortar consumption by trying to recommend the shortest possible embedment depth.

Concrete Compressive Strut

The strut-and-tie model assumes that the compression strut C_0 is anchored at the center of the anchorage zone and that its thickness corresponds to the length of the anchorage zone ℓ_b .

$$F_{c0} = \frac{M_1 + (V_2 + V_3) \cdot z_1 / 2}{z_0} \quad (\text{horizontal component of concrete strut force})$$

$$D_0 = F_{c0} / \cos \theta_{FN} \quad (\text{concrete force in direction of strut})$$

$$\sigma_{Rd,max} = v' \cdot k_2 \cdot \alpha_{cc} \cdot f_{ck} / \gamma_c \quad (\text{reduced concrete strength in tension-compression node according to ENV1992-1-1, 4.5.4(4b). Standard parameters: } v'=1-f_{ck}/250; k_2=0.85; \alpha_{cc}=1.0; \gamma_c=1.5, \text{ subject to variations in National Application Documents})$$

$$D_{0,R} = \sigma_{Rd,max} \cdot \ell_b \cdot w \cdot \cos \theta_{FN} \quad (\text{resistance of concrete in strut direction, } w=\text{width of section})$$

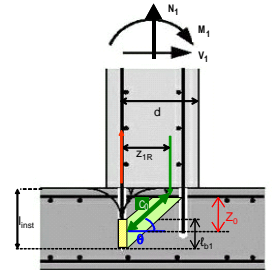

If $D_{0R} \geq D_0$ the concrete strut can take up the loads introduced from the new section.

Splitting of Concrete in Transition Area

On the left hand side of the anchorage zone, the compression force is continuing through additional struts to the tension and compression zones of the B-region of the slab where the equilibrium of the horizontal forces is given. The vertical components of these struts are taken up by tensile stresses in the concrete. Normally there is no vertical reinforcement in the slab to take up the tension force. The loads and thermal solicitations of a slab do not lead to horizontal cracking; therefore it is possible to attribute the tension force to the tensile capacity of the concrete. On the safe side, the maximum splitting stress has been taken as that caused by a concentrated load C_0 on the center of the anchorage zone. It has been shown that the occurring splitting stress $\max \sigma_{sp}$ can be calculated as

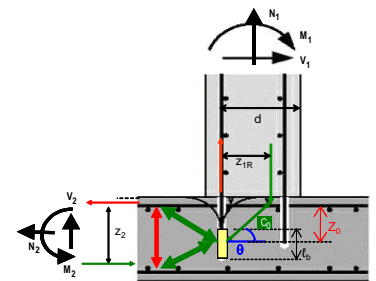

$$\max \sigma_{sp} = \left(M_1 + \frac{(V_2 + V_3) \cdot z_1}{2} \right) \cdot \left(1 - \frac{z_0}{z_2} \right) \cdot \left(1 - \frac{\ell_b}{2 \cdot z_2} \right) \cdot \left(\frac{2.42}{b \cdot z_2^2} \right) \leq f_{ct}$$

with: M_1, V_2, V_3 : external forces on node according to figure 5
 z_2 : inner lever arm of slab section outside node region
 b : width of the wall section
 $f_{ctd} = \alpha_{ct} \cdot 0.7 \cdot 0.3 \cdot f_{ck}^{2/3} / \gamma_c$: tensile strength of concrete (Standard value in EC2: $\alpha_{ct}=1.0$, subject to variations in National Application Documents)

If the calculated maximum splitting stress is smaller than the tensile strength of the concrete f_{ct} , then the base plate can take up the splitting forces without any additional shear reinforcement.

2.3.3 Design Examples

a) End support of slab, simply supported

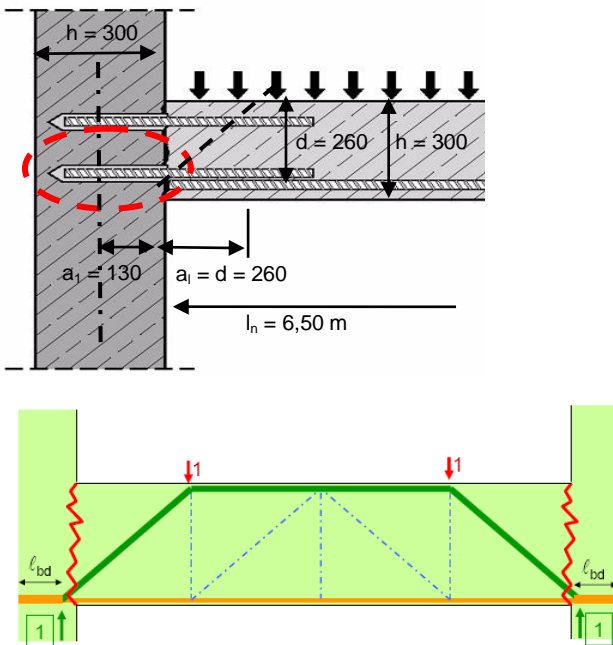

slab: $l_n = 4,50\text{m}$, $Q_k = 20\text{ kN/m}^2$, $h = 300\text{ mm}$, $d = 260\text{ mm}$

wall: $h = 300\text{ mm}$

Concrete strength class: C20/25, dry concrete

Reinforcement: $f_{yk} = 500\text{ N/mm}^2$, $\gamma_s = 1.15$

Loads: $G_k = 25\text{ kN/m}^3 \cdot h = 7.5\text{ kN/m}^2$;
 $S_d = (1.50 \cdot Q_d + 1.35 \cdot G_k) = 40.1\text{ kN/m}^2$

Structural analysis (design forces):

$$M_{Ed} = S_d \cdot l_n^2 / 8 = 102\text{ kNm/m}$$

$$V_{Ed} = S_d \cdot l_n / 2 = 90.3\text{ kN/m}$$

Bottom reinforcement required at mid span:

$$A_{s,rqd,m} = (M_{sd} \cdot \gamma_s) / (0.9 \cdot d \cdot f_{yk}) = 998\text{ mm}^2/\text{m}$$

reinforcement provided at mid span: $\varnothing 16$, $s = 200\text{ mm}$

$$A_{s,prov,m} = 1005\text{ mm}^2/\text{m}$$

Bottom reinforcement at support:

Tension force to be anchored: $F_{Ed} = |V_{Ed}| \cdot a_1 / (0.9d) = 100\text{ kN/m}$ (Clause 9.2.1.4(2), EC2: EN 1992-1-1:2004)

Steel area required: $A_{s,rqd} = F_{Ed} \cdot \gamma_s / f_{yk} = 231\text{ mm}^2/\text{m}$

Minimum reinforcement to be anchored at support:

$A_{s,min} = k_c \cdot k \cdot f_{ct,eff} \cdot A_s / \sigma_s = 0,4 \cdot 1 \cdot 2,2 \cdot 150 \cdot 1000 / 500 = 264\text{ mm}^2/\text{m}$ (Clause 7.3.2(2), EC2: EN 1992-1-1:2011)

$A_{s,min} = 0,5 \cdot A_{s,rqd,m} = 0,50 \cdot 988 = 499\text{ mm}^2/\text{m}$ (Clause 9.3.1.2(1), EC2: EN 1992-1-1:2011)

$A_{s,min} = 0,25 \cdot A_{s,prov,m} = 0,25 \cdot 1010 = 251\text{ mm}^2/\text{m}$ (Clause 9.2.1.4(1), EC2: EN 1992-1-1:2011)

Decisive is $499\text{ mm}^2/\text{m} \Rightarrow$ reinforcement provided: $\varnothing 12$, $s = 200\text{ mm} \Rightarrow A_{s,prov} = 565\text{ mm}^2/\text{m}$;

Installation by hammer drilling; Hilti HIT-RE 500

Minimum anchorage length

$\sigma_{sd} = (A_{s,rqd} / A_{s,prov}) \cdot (f_{yk} / \gamma_s) = (23 / 565) \cdot (500 / 1,15) = 177\text{ N/mm}^2$

$f_{bd,EC2} = 2,3\text{ N/mm}^2$ (EC 2 for minimum length. see tech. data, sect. 6)

$l_{b,rqd} = (\phi / 4) \times (\sigma_{sd} / f_{bd}) = (12 / 4) \times (177 / 2.3) = 231\text{ mm}$

$l_{b,min} = \max \{0.3 l_{b,rqd}; 10\phi; 100\text{mm}\} = 120\text{ mm}$ (Clause 8.4.4(1), EC2: EN 1992-1-1:2011)

Development length:

Cover dimension: $c_d = (s - \phi) / 2 = 94\text{ mm}$

Confinement $c_d / \phi = 94 / 12 = 7.8$

Splitting bond strength for $c_d/\phi > 3$:

$$\alpha_2' = \frac{1}{\frac{1}{0.7} + \delta \cdot \frac{c_d - 3\phi}{\phi}} = \frac{1}{\frac{1}{0.7} + 0.306 \cdot \frac{94 - 3 \cdot 12}{12}} = 0.344$$

$$f_{bd,spl,2} = \frac{f_{bd,EC2}}{\max(\alpha_2'; 0.25)} = \frac{2.3}{0.344} = 6.7 \text{ N/mm}^2$$

Pullout bond strength: $f_{bd,p} = 8.6 \text{ N/mm}^2$ (see tech. data, sect. 6)

Applicable design bond strength: $f_{bd} = \min(f_{bd,spl}; f_{bd,p}) = 6.7 \text{ N/mm}^2$

Design development length: $\ell_{bd} = (\phi/4) \cdot (\sigma_{sd}/f_{bd}) = 80 \text{ mm}$

Minimum length controls \rightarrow drill hole length $\ell_{ef} = 120 \text{ mm}$

Top reinforcement at support:

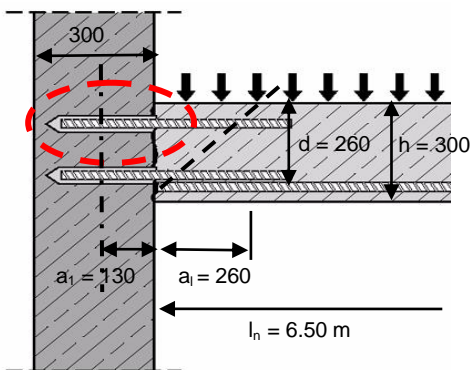

Minimum reinforcement:

- a) 25% of bottom steel required at mid-span
{Clause 9.3.1.2(2), EC2: EN 1992-1-1:2004}
 $A_{s,req} = 0,25 \cdot 988 = 247 \text{ mm}^2/\text{m}$
- b) requirement for crack limitation :
{Clause 7.3.2(2), EC2: EN 1992-1-1:2004}
 $A_{s,min} = 0,4 \cdot 1 \cdot 2,2 \cdot 150 \cdot 1000 / 435 = 303 \text{ mm}^2/\text{m}$

Decisive is 303 mm²/m

\Rightarrow reinforcement provided: $\varnothing 10, s = 200 \text{ mm}; A_{s,prov} = 393 \text{ mm}^2/\text{m}$

Design stress in bar: $\sigma_{sd} = f_{yd} \cdot A_{s,min} / A_{s,prov} = 335 \text{ N/mm}^2$

Minimum anchorage length

$\sigma_{sd} = (A_{s,rqd} / A_{s,prov}) \cdot (f_{yk}/\gamma_s) = (23 / 565) \cdot (500/1,15) = 335 \text{ N/mm}^2$

$f_{bd,EC2} = 2,3 \text{ N/mm}^2$ (EC 2 for minimum length. see tech. data, sect. 6)

$\ell_{b,rqd} = (\phi / 4) \times (\sigma_{sd} / f_{bd}) = (10 / 4) \times (335 / 2.3) = 364 \text{ mm}$

$\ell_{b,min} = \max \{0.3\ell_{b,rqd}; 10\phi; 100\text{mm}\} = 110 \text{ mm}$ (Clause 8.4.4(1), EC2: EN 1992-1-1:2011)

Development length:

Cover dimension: $c_d = (s - \phi)/2 = 95 \text{ mm}$

Confinement $c_d/\phi = 95/10 = 9.5$

Splitting bond strength for $c_d/\phi > 3$:

$$\alpha_2' = \frac{1}{\frac{1}{0.7} + \delta \cdot \frac{c_d - 3\phi}{\phi}} = \frac{1}{\frac{1}{0.7} + 0.306 \cdot \frac{95 - 3 \cdot 10}{10}} = 0.293$$

$$f_{bd,spl,2} = \frac{f_{bd,EC2}}{\max(\alpha_2'; 0.25)} = \frac{2.3}{0.293} = 7.9 \text{ N/mm}^2$$

Pullout bond strength: $f_{bd,p} = 8.6 \text{ N/mm}^2$ (see tech. data, sect. 6)

Applicable design bond strength: $f_{bd} = \min(f_{bd,spl}; f_{bd,p}) = 7.9 \text{ N/mm}^2$

Design development length: $\ell_{bd} = (\phi/4) \cdot (\sigma_{sd}/f_{bd}) = 97 \text{ mm}$

Minimum length controls → drill hole length $l_{ef} = 110 \text{ mm}$

Therefore, drill hole length $l_{ef} = 110 \text{ mm}$

If wet diamond core drilling is used:

$l_{b,min} = \max \{0,3l_{b,reqd}; 10\phi; 100\text{mm}\} \cdot 1.5 = 180 \text{ mm}$ (as wet diamond core drilling is used, the minimum values according do EC2 have to be multiplied by 1.5, see tech data)

-> in this case the minimum length will control, drill hole length $l_{ef} = 180 \text{ mm}$ for upper and lower layers

b) Wall bending connection

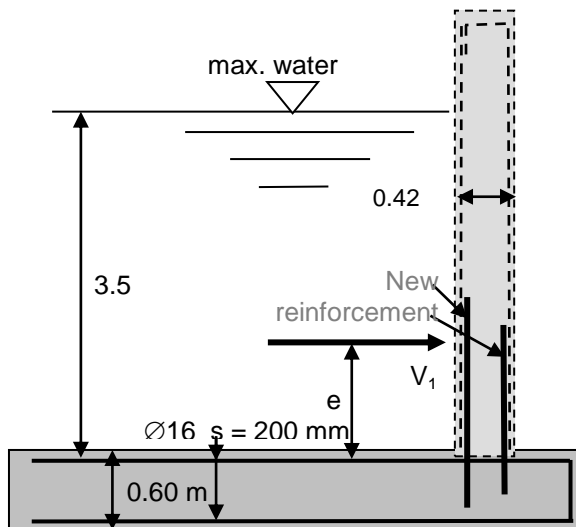

Note: transverse reinforcement not

Geometry:

$h_1 = 420 \text{ mm}; h_2 = h_3 = 600 \text{ mm};$
 $d_1 = 380 \text{ mm}; d_2 = d_3 = 560 \text{ mm};$
 $z_1 = 360 \text{ mm}; z_2 = z_3 = 520 \text{ mm}$
 $A_{s0} = A_{s2} = A_{s3} = 1005 \text{ mm}^2/\text{m} (\text{Ø}16 \text{ s} = 200 \text{ mm})$
 $c_s = h_2 - d_2 = 40 \text{ mm}$

Material:

Concrete: C20/25 (new and existing parts), $\gamma_s = 1.5$
 Steel grade: 500 N/mm², $\gamma_s = 1.15$
 Safety factor for variable load: $\gamma_Q = 1.5$
 HIT-RE 500-SD (temperature range I)

Acting loads:

$$V_{1d} = \gamma_Q \cdot p \cdot h^2 / 2 = 1.4 \cdot 10 \cdot 3.5^2 / 2 = 92 \text{ kN/m}$$

$$e = h / 3 = 3.5 / 3 = 1.17 \text{ m}$$

$$M_{1d} = V_{1d} \cdot e = 92 \cdot 1.17 = 107 \text{ kNm/m}$$

Force in post-installed reinforcement

$$z_{1r} = 0.85 \cdot z_1 = 0.85 \cdot 360 = 306 \text{ mm} \quad (\text{opening moment} \rightarrow \text{reduced inner lever arm})$$

$$F_{s1d} = M_{1d} / z_{1r} = 107 / 0.306 = 350 \text{ kN/m}$$

$$A_{s1,rqd} = F_{s1d} / (f_{yk} / \gamma_{Ms}) = 350 \cdot 1000 / (500 / 1.15) = 805 \text{ mm}^2/\text{m}$$

Select $\phi 12 \text{ mm}$, spacing $s_1 = 125 \text{ mm} \rightarrow A_{s1,prov} = 905 \text{ mm}^2$

\rightarrow drilled hole diameter: $d_0 = 16 \text{ mm}$

Stress in bar: $\sigma_{sd} = F_{s1d} / A_{s1,prov} = 386 \text{ N/mm}^2$

anchorage length

$$f_{bd,EC2} = 2.3 \text{ N/mm}^2 \quad (\text{EC 2 for minimum length})$$

$$\ell_{b,rqd,EC2} = (\phi/4) \cdot (\sigma_{sd} / f_{bd,EC2}) = 504 \text{ mm}$$

$$\ell_{b,min} = \max \{0,3\ell_{b,rqd,EC2}; 10\phi; 100 \text{ mm}\} = 151 \text{ mm}$$

$$f_{bd,b} = 8.3 \text{ N/mm}^2 \quad (\text{see tech. data, sect. 6})$$

$$c_d = s_1/2 - \phi/2 = 56.5 \text{ mm} > 3\phi = 0.512$$

$$\alpha_2' = \frac{1}{\max \left[\frac{1}{0.7 + \delta \cdot \frac{c_d - 3\phi}{\phi}}; 0.25 \right]} = 4.5 \text{ N/mm}^2$$

$$f_{bd,spl2} = \frac{f_{bd}}{\max[\alpha_2'; 0.25]} = 4.5 \text{ N/mm}^2$$

$$f_{bd} = \min\{f_{bd,b}; f_{bd,spl}\} = 4.5 \text{ N/mm}^2$$

$$\ell_{b1} = \max\{(\phi/4) \cdot (\sigma_{sd} / f_{bd}); \ell_{b,min}\} = 258 \text{ mm}$$

Drilled hole length

$$l_{inst,max} = h_2 - \max\{2d_0; 30\text{mm}\} = 568 \text{ mm} \quad (\text{maximum possible hole length})$$

$$l_{inst,60} = c_s + z_{1R} \cdot \tan 60^\circ + l_{b1} / 2 = 672 \text{ mm} \quad (\text{hole length corresponding to } \theta=60^\circ)$$

$$l_{inst,60} > l_{inst,max} \rightarrow \text{select hole length } l_{inst} = l_{inst,max} = 568 \text{ mm}$$

$$\text{Strut angle with } l_{inst,max}: \tan \theta = (l_{inst,max} - c_s - l_{b1}/2) / z_{1R} \rightarrow \theta_{FN} = 53^\circ$$

check: $\theta > 30^\circ \rightarrow \text{ok}$

Reaction in Foundation:

$$-M_{2d} = M_{1d} + V_{1d} \cdot z_2 / 2 = 107 + 0.25 \cdot 92 = 131 \text{ kNm/m}$$

$$N_{2d} = -V_{1d} = -92 \text{ kN/m}$$

$$M_{s3} = 0; V_{2d} = V_{3d} = 0; N_1 = N_3 = 0$$

Check of foundation reinforcement

$$F_{s2d} = M_{2d} / z_2 + N_{2d} / 2 = 298 \text{ kNm/m} \quad (\text{tension outside node area})$$

$$z_0 = l_{inst} - c_s - l_{b1} / 2 = 568 - 40 - 258/2 = 399 \text{ mm} \quad (\text{lever arm in node area})$$

$$H_{s2d} = M_{1d} \cdot (1/z_0 - 1/z_2) + V_{1d} \cdot (z_1/z_0 - 1) = 53 \text{ kNm/m} \quad (\text{additional force in node area})$$

$$F_{s2d,node} = F_{s2d} + H_{s2d} = 351 \text{ kNm/m} \quad (\text{tension in node area})$$

$$A_{s2,rqd} = F_{s2d,node} / (f_{yk} / \gamma_{Ms}) = 351 \cdot 1000 / (500 / 1.15) = 808 \text{ mm}^2/\text{m}$$

$$A_{s2} > A_{s2,rqd} \rightarrow \text{ok} \quad (A_{s2} \text{ is given})$$

Check concrete compressive strut

$$F_{c0d} = M_{1d} / z_0 = 268 \text{ kN/m}$$

$$D_{0d} = F_{c0d} / \cos \theta_{FN} = 441 \text{ kN/m}$$

$$\alpha_{ct} = 1.0 \quad (\text{EC2: EN 1992-1-1:2004, 3.1.6(1)})$$

$$v' = 1 - f_{ck} / 250 = 0.92 \quad (\text{EC2: EN 1992-1-1:2004, 6.5.2(2)})$$

$$k_2 = 0.85 \quad (\text{EC2: EN 1992-1-1:2004, 6.5.4(4b)})$$

$$D_{0Rd} = \alpha_{ct} \cdot v' \cdot k_2 \cdot f_{ck} / \gamma_c \cdot l_{b1} \cdot \cos \theta_{FN} = 1639 \text{ kN/m}$$

$$D_{0Rd} > D_{0d} \rightarrow \text{ok}$$

Check concrete splitting in plane of foundation

$$\alpha_{ct} = 1.0 \quad (\text{EC2: EN 1992-1-1:2004, 3.1.6(2)})$$

$$f_{ctk,0.05} = \alpha_{ct} \cdot 0.7 \cdot 0.3 \cdot f_{ck}^{2/3} / \gamma_c = 1.03 \text{ N/mm}^2 \quad (\text{table 3.1, EC2: EN 1992-1-1:2004})$$

$$M_{sp,d} = F_{c0d} \cdot z_0 \cdot (1 - z_0/z_2) \cdot (1 - l_{b1}/(2z_2)) = 1.87 \cdot 10^7 \text{ Nmm/m}$$

$$W_{sp} = 1000\text{mm} \cdot z_2^2 / 2.41 = 1.12 \cdot 10^8 \text{ mm}^3/\text{m}$$

$$\max \sigma_{sp} = M_{sp,d} / W_{sp} = 0.17 \text{ N/mm}^2$$

$$f_{ctk,0.05} > \max \sigma_{sp} \rightarrow \text{ok}$$

2.4 Load Case Fire

The bond strength in slabs under fire has been evaluated in tests and is certified by reports of the Technical University of Brunswick, Germany. The conformity with the German standards is confirmed in DIBt German national approvals, the one with British Standard BS8110:1997 in the Warrington Fire Report. French cticm Approvals also give data for beams. These documents are downloadable from the Intranet for the different adhesive mortars.

There are two types of design tables corresponding to the basic fire situations “parallel” and “anchorage”.

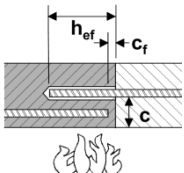

In the fire situation “parallel” the only parameter is the clear distance from the fire exposed concrete surface to the perimeter of the bar (“clear concrete cover c”). From this parameter, one can directly read the bond strength of the adhesive for specific fire durations.

In fire design, it influences like is sufficient to anchorage load under fire

$\tau_{Rd,fi}$

Clear concrete cover c [mm]	Max. bond stress, τ_c [N/			
	F30	F60	F90	F120
10	0	0	0	0
20	0,494	0	0	0
30	0,665	0	0	0
40	0,897	0,481	0	0
50	1,200	0,623	0	0
60	1,630	0,806	0,513	0
70	2,197	1,043	0,655	0,487
80	2,962	1,351	0,835	0,614
90	3,992	1,748	1,065	0,775
100	5,382	2,263	1,358	0,977
110	7,255	2,930	1,733	1,233
120	9,780	3,792	2,210	1,556
130		4,909	2,818	1,963
140	11,00	6,355	3,594	2,477
150		8,226	4,584	3,125

is not necessary to re-calculate bond condition or alpha factors. It prove that the calculated splice or length is sufficient to transmit the with the given fire bond strength

$$F_{fire} = f_{bd,fi} \cdot \phi \cdot \pi \cdot h_{ef}$$

Fire design

table for situation „parallel“

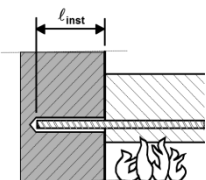

In the fire situation “anchorage” the tables directly show the fire resistance as a force [kN] for given diameters, embedment depths and fire durations.

The tables mention a maximum steel force in fire. It is important to know that this value is derived for a specific assumed value of $f_{yk,fi}$ (see sect. 2.1.2) and will be different for other values of $f_{yk,fi}$. In the published tables

Bar \varnothing [mm]	Drill hole \varnothing [mm]	Max. $F_{s,T}$ [kN]	l_{inst} [mm]	F30 [kN]	F60 [kN]	F90 [kN]		
8	12	16,2	80	2,18	0,73	0,24		
			120	8,21	2,90	1,44		
			170	16,2	9,95	5,99		
			210		16,2	13,01		
			230			16,2		
			250					
10	14	25,3	100	5,87	1,95	0,84		
			150	16,86	8,06	4,45		
			190	25,3	16,83	11,86		
			230		25,3	20,66		
			260			25,3		
			280					
			320					
			120			12,32	4,35	2,16
			180			28,15	17,56	11,59

$f_{yk,fi}=322N/mm^2$ was normally assumed; if this value was given as e.g. $f_{yk,fi}=200N/mm^2$ the maximum force for bar diameter 8mm in the table below would be Max. $F'_{s,T}=10.1kN$. This would then imply that in the columns on the right side, all values would be cut off at 10.1kN, i.e. the values 16.2 or 13.01 would not appear any more.) That means that there is no such thing as a given maximum force in fire.

Intermediate values between those given in the fire design tables may be interpolated linearly. Extrapolating is not permitted.

$$R_{fire} = \phi \cdot \pi \cdot \sum_{i=1}^n \tau_{crit,fi} \cdot l_i$$

Fire design table for situation „anchorage“

2.5 Fatigue of bonded-in reinforcement for joints

General notes

For load bearing elements which are subjected to considerable cyclic stress the bonded-in connections should be designed for fatigue. In that case evidence for fatigue of reinforcing steel bars, concrete and bond should be provided separately.

For simple cases it is reasonable to use simplified methods on the safe side.

The partial safety factors for loads are specified in the code for reinforced concrete.

The partial safety factors for material are specified in Table 4.3.

Table 4.3: Partial safety factors for materials subjected to cyclic loading

Evidence for	concrete	bond	reinforcing bars (steel)
Partial safety factor	1.5	1.8	1.15

Fatigue of reinforcing bars (steel)

The resistance for fatigue of reinforcing bars (steel) is specified in the actual code for reinforced concrete. The behaviour of the steel of reinforcing bars bonded-in by means of HIT-Rebar is at least as good as cast-in place reinforcement.

Fatigue of bond and concrete (simplified approach)

As a simple and conservative approach on the safe side evidence for fatigue is proven if the following equation is valid:

$$F_{Sd,fat} \leq N_{Rd} \cdot f_{fat}$$

where:

$F_{Sd,fat}$ Design value of the anchorage force for the ruling loading model for fatigue.

N_{Rd} Design resistance for static load of the anchorage (bond and concrete).

f_{fat} Reduction factor for fatigue for bond and concrete: $f_{fat} = 0.5$

If max/min of cycles is known, reduction factors are shown in Figure 4.13.

Diagram for a simplified approach with $2 \cdot 10^6$ cycles (Weyrauch diagram)

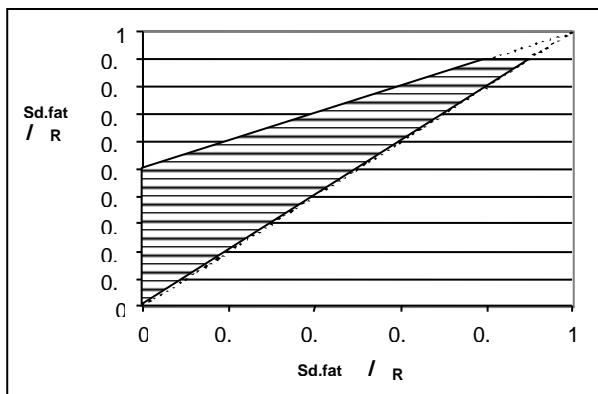
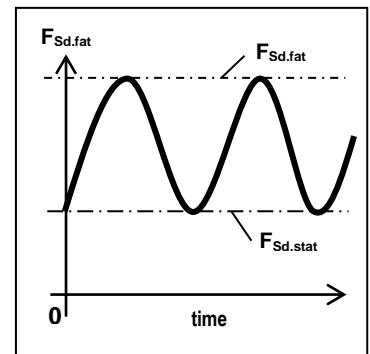

Reduction factors for fatigue for bond and concrete

If the simplified method is not satisfying, additional information using the "Woehler" - lines is available.

Ask Hilti Technical Service for the Hilti Guideline: TWU-TPF 06a/02 HIT-Rebar: Fatigue.

Design Approach

Steel resistance:

The steel resistance under fatigue load is calculated from the part of the load which is permanent, the allowable stress variation and the steel yield strength. The safety factors are the same as those used for static design (taken from ENV 1992-2-2:1996, sect. 4.3.7.2).

$\Delta\sigma_{s,max}$ = ... maximum allowable stress variation, usually given by codes, e.g. ENV 1992-2-2:1996,

sect. 4.3.7.5: $\Delta\sigma_{s,max} = 70N/mm^2$

P percentage of the load which is permanent: $0 \leq P \leq 100$

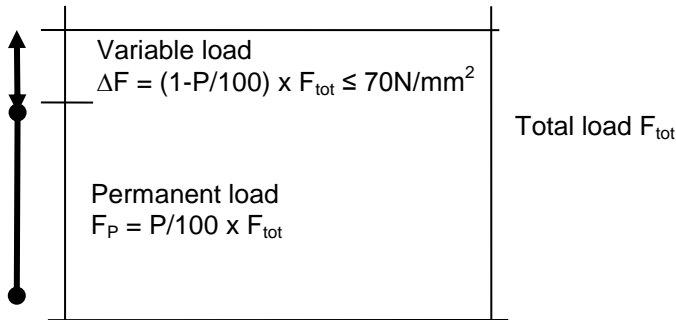

The reduction factor on steel resistance due to dynamic loading is then:

$$f_{red,s,dyn} = \frac{\min(f_{yk}; \frac{70}{1-P/100})}{f_{yk}}$$

And the steel strength taken into account for fatigue loading is

$$\sigma_{s,max,dyn} = f_{red,s,dyn} \cdot f_{yk}$$

Concrete Resistance

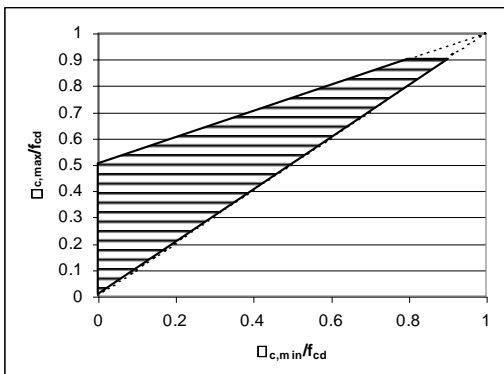

The concrete resistance calculated for static loading is reduced by a reduction factor for fatigue loads, $f_{red,c,dyn}$, which is applied to all types of concrete failure, i.e. splitting, shear in uncracked and shear in cracked concrete. This factor is calculated from the Weyrauch diagram of Eurocode 2 (ENV 1992-2-2:1996, section 4.3.7.4):

$$f_{red,c,dyn} = 0.5 + 0.45 \cdot \frac{P}{100} \leq 0.9$$

For $P=100$ (only permanent loads), $f_{red,c,dyn}$ is, of course 1.0, but as soon as $P < 100$, $f_{red,c,dyn} \leq 0.9$.

Bond Resistance

The bond resistance calculated for static loading is reduced by a reduction factor for fatigue loads, $f_{red,b,dyn}$. This factor is calculated from the Weyrauch diagram based on in-house testing and literature reviews [8]. It has to be chosen between two formulas depending on the situation.

a) in general: $f_{red,b,dyn} = 0.63 + 0.37 \cdot \frac{P}{100} \leq 0.9$

b) HIT-RE 500 in diamond drilled, water saturated hole: $f_{red,b,dyn} = 0.53 + 0.47 \cdot \frac{P}{100} \leq 0.9$

For $P=100$ (only permanent loads), $f_{red,c,dyn}$ is, of course 1.0, but as soon as $P<100$, $f_{red,c,dyn} \leq 0.9$.

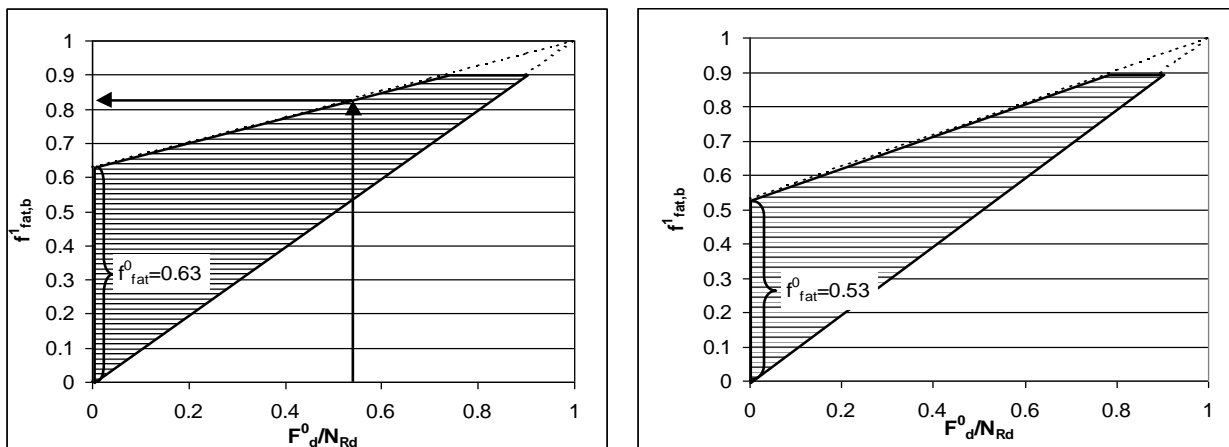

2.6 Seismic design of structural post-installed rebar

An increasing population density, the concentration of valuable assets in urban centers and society's dependence on a functioning infrastructure demand a better understanding of the risks posed by earthquakes. In several areas around the globe, these risks have been reduced through appropriate building codes and state of the art construction practices. The development of pre-qualification methods to evaluate building products for seismic conditions additionally contributes to safer buildings for generations to come.

Approval DTA 3/10-649 [10] delivered by CSTB, a member of EOTA, recognizes Hilti HIT-RE 500-SD injectable mortar as a product qualified for structural rebar applications in seismic zones. This national approval requires that qualified products have an ETA approval for rebar, an ETA approval for anchorage in cracked concrete, as well as an ICC-ES pre-qualification for seismic conditions.

The design procedure is fully details in the approval and, in addition to detailing rules of EC2/rebar ETA, consider the following detailing rules of EN1998-1:2004 (Eurocode 8) [11]:

- max $f_{yk} = 500 \text{ N/mm}^2$
- restricted concrete strengths range: C20/25 to C45/55
- only ductile reinforcement (class C)
- no combination of post-installed and e.g. bent connection bars to ensure displacement compatibility
- columns under tension in critical (dissipation) zones: increase l_{bd} and l_0 , respectively, by 50%
- specific bond strength $f_{bd,seism}$ presented in the following table

By applying engineering judgment, engineers can use this French application document when designing seismic structural post-installed rebar connections. This mentioned practice is presently the only available and fully operational code based procedure in Europe and can as such be considered state-of-the-art.

2.7 Corrosion behaviour

The Swiss Association for Protection against Corrosion (SGK) was given the assignment of evaluating the corrosion behaviour of fastenings post-installed in concrete using the Hilti HIT-HY 200 and Hilti HIT-RE 500 injection systems.

Corrosion tests were carried out. The behaviour of the two systems had to be evaluated in relation to their use in field practice and compared with the behaviour of cast-in reinforcement. The SGK can look back on extensive experience in this field, especially on expertise in the field of repair and maintenance work.

The result can be summarized as follows:

Hilti HIT-HY 200

- The Hilti HIT-HY 200 systems in combination with reinforcing bars can be considered resistant to corrosion when they are used in sound, alkaline concrete. The alkalinity of the adhesive mortar safeguards the initial passivation of the steel. Owing to the porosity of the adhesive mortar, an exchange takes place with the alkaline pore solution of the concrete.
- If rebars are bonded-in into chloride-free concrete using this system, in the event of later chloride exposure, the rates of corrosion are about half those of rebars that are cast-in.
- In concrete containing chlorides, the corrosion behaviour of the system corresponds to that of cast-in rebars. Consequently, the use of unprotected steel in concrete exposed to chlorides in the past or possibly in the future is not recommended because corrosion must be expected after only short exposure times.

Hilti HIT-RE 500 + Hilti HIT-RE 500-SD

- If the Hilti HIT-RE 500 system is used in corrosive surroundings, a sufficiently thick coat of adhesive significantly increases the time before corrosion starts to attack the bonded-in steel.
- The HIT-RE 500 system may be described as resistant to corrosion, even in concrete that is carbonated and contains chlorides, if a coat thickness of at least 1 mm can be ensured. In this case, the unprotected steel in the concrete joint and in the new concrete is critical.
- If the coat thickness is not ensured, the HIT-RE 500 system may be used only in sound concrete. A rebar may then also be in contact with the wall of the drilled hole. At these points, the steel behaves as though it has a thin coating of epoxy resin.
- In none of the cases investigated did previously rusted steel (without chlorides) show signs of an attack by corrosion, even in concrete containing chlorides.
- Neither during this study an acceleration of corrosion was found at defective points in the adhesive nor was there any reference to this in literature. Even if a macro-element forms, the high resistance to it spreading inhibits a locally increased rate of corrosion.
- Information in reference data corresponds with the results of this study.

3 Design Programme PROFIS Rebar

The PROFIS Rebar™ design programme allows rapid and safe design of post-installed reinforcement connections.

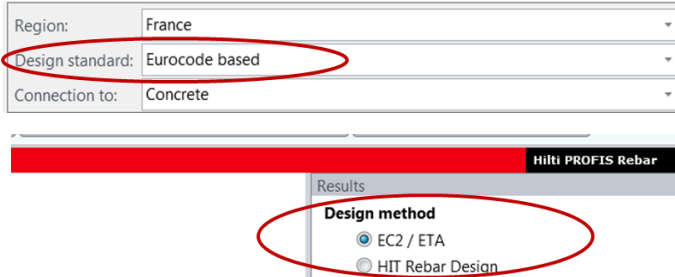

When a new project is opened, the user selects between the design methods “Eurocode based” and “ACI based” design methods. After this, the necessary data concerning existing structure, new rebars and loads have to be defined.

The results pane to the right of the drawing lets the user switch between the methods “EC2 / ETA” (see section 2.2) and “HIT rebar design” (see section 2.3).

In the left hand ribbon of the screen, the user can then select the adhesive mortar to be used and either the bar size or the spacing for top and bottom layers. Based on the input data, the program calculates the section forces in steel and concrete as well as the position of the neutral axis. (Elastic-plastic behaviour of the steel is assumed, strain hardening is not taken into account.)

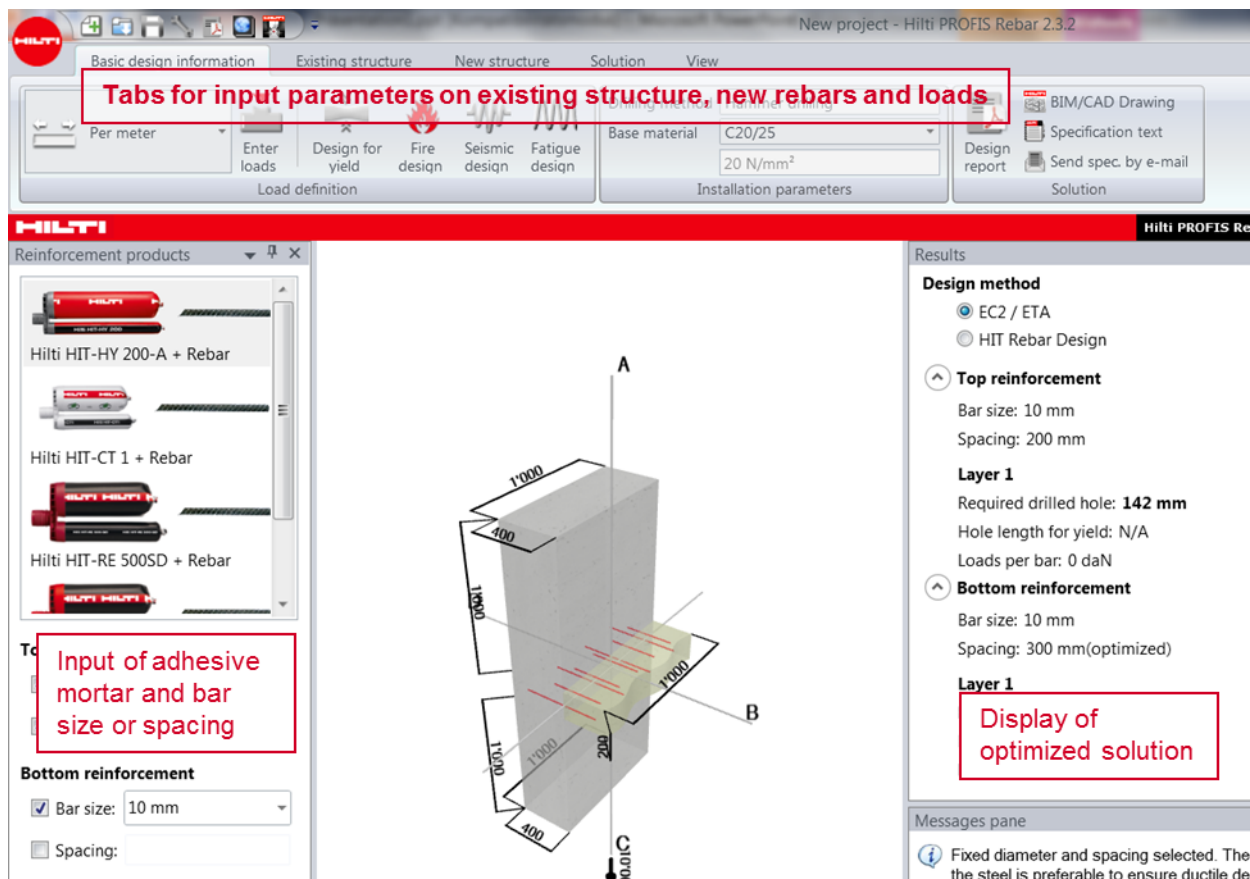

In the right hand ribbon the optimized solution, i.e. the one which uses the least possible cross section of connecting steel is indicated immediately.

Under the “calculation” tab, the user can get all possible solutions and select the appropriate one from a table.

Under the “solution tab” it is possible to print a design report, to download installation instructions or approvals, to access the Hilti online technical library or to send a specification by e-mail

The applications are shown in the following table. For each case the table shows if there is a solution and if yes, which cast-in reinforcement must be defined in order to obtain a solution:

	New and existing members parallel	New and existing members perpendicular		
	<p>design method:</p>	<p>design method:</p>		
Load	EC2 / ETA	Hit Rebar	EC2 / ETA	Hit Rebar
compression and/or shear 	With high compression requiring compressive reinforcement, existing reinforcement to be spliced is needed		definition of cast-in reinforcement not required	
bending moment, shear and/or compression 	Overlap splice: Parallel cast-in reinforcement to be defined		<i>No solution, concrete in tension</i> → PROFIS Anchor	Frame node: Perpendicular cast-in reinforcement to be defined
tension with or without bending moment and/or shear 	Overlap splice: Parallel cast-in reinforcement to be defined		<i>No solution, concrete in tension</i> → PROFIS Anchor	

Assumptions made by PROFIS Rebar in frame node design

Note that PROFIS Rebar is making simplified assumptions: it considers only the reactions to N_1 , V_1 , M_1 and it attributes them to the side of the base slab which is defined longer. If both sides of the base slab have the same length, the reaction is distributed to both sides equally:

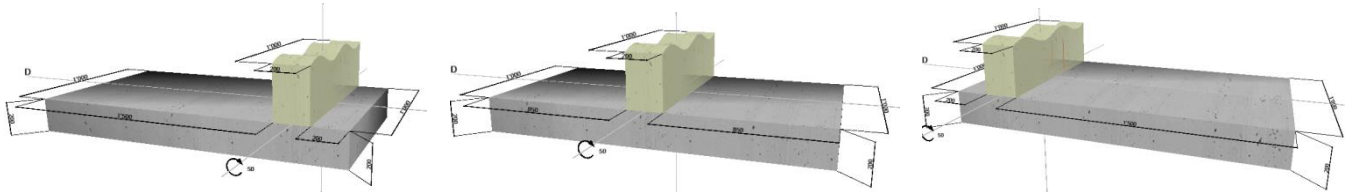

$$M_2 = -M_1 + V_1 \cdot \frac{z_2}{2} + N_1 \cdot \frac{z_1}{2}$$

$$M_3 = 0$$

$$V_2 = N_1; \quad V_3 = 0$$

$$N_2 = V_1; \quad N_3 = 0$$

$$M_2 = 0$$

$$M_3 = -M_1 + V_1 \cdot \frac{z_2}{2} + N_1 \cdot \frac{z_1}{2}$$

$$V_2 = 0; \quad V_3 = N_1$$

$$N_2 = 0; \quad N_3 = V_1$$

$$M_2 = 0.5 \cdot \left(-M_1 + V_1 \cdot \frac{z_2}{2} + N_1 \cdot \frac{z_1}{2} \right)$$

$$M_3 = 0.5 \cdot \left(-M_1 + V_1 \cdot \frac{z_2}{2} + N_1 \cdot \frac{z_1}{2} \right)$$

$$V_2 = V_3 = N_1 / 2;$$

$$N_2 = N_3 = V_1 / 2$$

Global equilibrium of the node as assumed in PROFIS Rebar

It is important to realize that the checks made by PROFIS Rebar are ONLY for the efforts introduced by the loading of the new concrete part. If the existing part is already loaded by other efforts, the total loading needs to be considered separately by the designer.

In analogy to the global equilibrium of the node, PROFIS Rebar makes the distinction between opening and closing moment on the basis of the length of the existing perpendicular parts on each side of the new part. The case where both perpendicular members have the same length is considered as opening moment since this yields results on the safe side.

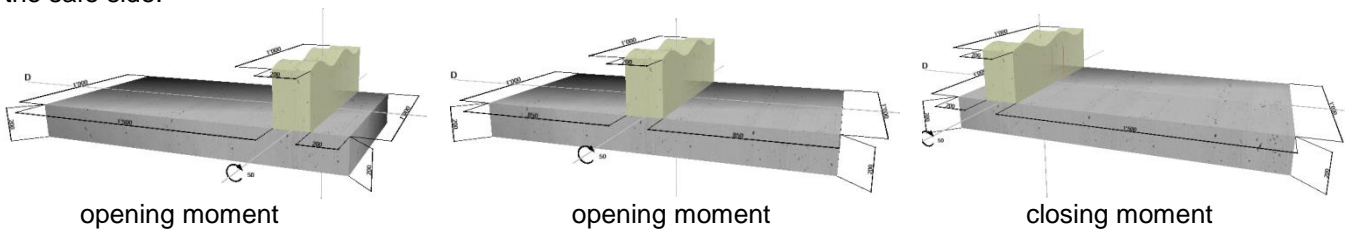
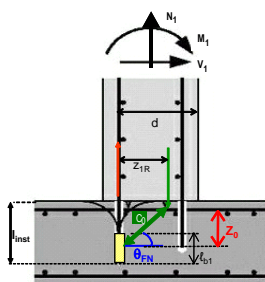

Figure 6: opening and closing moments assumed in PROFIS Rebar

Embedment depth:



- PROFIS Rebar will check the maximum possible setting depth according to ETAG 001, part 5: $h_{ef,max} = h_{member} - \max(2d_0; 30mm)$
- If $h_{ef,max}$ results in a strut angle $\theta_{FN} > 60^\circ$, the drill hole length will be selected such that $\theta_{FN} = 60^\circ$
- If $h_{ef,max}$ results in a strut angle $30^\circ \leq \theta_{FN} \leq 60^\circ$, the drill hole length will be $h_{ef,max}$
- If $h_{ef,max}$ results in a strut angle $\theta_{FN} < 30^\circ$, the strut angle is too small and the model provides no solution.

4 References

- [1] EN 1992-1-1:2011 Part 1-1: General rules and rules for buildings (Eurocode 2); January 2011
- [2] EOTA: Technical Report TR 023, Assessment of post- installed rebar connections, Edition Nov. 2006
- [3] EOTA: Technical Report TR 029, Design of Anchors, Edition Sept. 2010
- [4] EOTA: ETAG 001, part 5. bonded anchors. Brussels, 2008.
- [5] Kunz, J., Muenger F.: Splitting and Bond Failure of Post-Installed Rebar Splices and Anchorings. Bond in Concrete. fib, Budapest, 20 to 22 November 2002
- [6] Hamad, B.S., Al-Hammoud, R., Kunz, J.: Evaluation of Bond Strength of Bonded-In or Post-Installed Reinforcement. ACI Structural Journal, V. 103, No. 2, March – April 2006.
- [7] Kupfer, H., Münger, F., Kunz, J., Jähring, A.: Nachträglich verankerte gerade Bewehrungsstäbe bei Rahmenknoten. Bauingenieur: Sonderdruck, Springer Verlag,
- [8] HIT-Rebar – Design of bonded-in reinforcement using Hilti HIT-HY 150 or Hilti HIT-RE 500 for predominantly cyclic (fatigue) loading. Hilti Corporate Research, TWU-TPF-06a/02-d, Schaan 2002
- [9] Randl, N: Expertise zu Sonderfällen der Bemessung nachträglich eingemörtelter Bewehrungsstäbe; Teile A, B, C. University of Applied Science of Carinthia. Spittal (Austria), 2011.
- [10] CSTB: Document Technique d'Application 3/10-649 Relevant de l'Agrément Technique Europeen ATE 09/0295. Marne la Vallée (France), June 2010.

Eurocode 8: Auslegung von Bauwerken gegen Erdbeben – Teil 1: Grundlagen, Erdbebeneinwirkungen und Regeln für Hochbauten; Deutsche Fassung EN 1998-1:2004. April 2006

5 Installation of Post-Installed Reinforcement

5.1 Joint to be roughened

The model of inclined compressive struts is used to transfer the shear forces through the construction joint at the interface between concrete cast at different times. Therefore a rough interface is required to provide sufficient cohesion in the construction joint {Clause 6.2.5(2), EC2: EN 1992-1-1:2004}. Rough means a surface with at least 3 mm roughness ($R_t > 3 \text{ mm}$), achieved by raking, exposing the aggregate or other methods giving an equivalent behaviour.

5.2 Drilling

5.2.1 Standard Drilling

Injection anchor systems are used to fix reinforcement bars into concrete. Fast cure products are generally used with rebar diameters up to 25mm and moderate hole depths of up to about 1.5m, depending on the ambient temperature. Slow cure systems can be used with larger bar diameters and deep holes: The deepest rebar fixing to our knowledge so far was 12m. As rebar embedment lengths are usually much longer than with standard anchor applications, there are a number of additional system components helping to provide high quality of installation:

Drilling aid: Rebars are usually situated close to the concrete surface. If a long drill hole is not parallel to the surface, the inner lever arm of the structure will decrease along the hole if the deviation is away from the surface and even worse, the hole may penetrate the concrete surface or result in insufficient cover if the deviation is towards the surface. According to the rebar approvals, the deviations to be taken into account are 0.08 times the hole length (4.6°) for compressed air drilling, 0.06 times the hole length (3.4°) with hammer drilling and 0.02 times the hole length (1.1°) if a drilling aid is used (optical help or drilling rig, see fig. 11).



Figure 2.9: drilling aids

Depending on the required minimum concrete cover in every section of the post-installed rebar, the minimum “edge distance” at the start of the drilled hole is then:

$$c_{\min} = 50 + 0,08 l_v \geq 2\phi \text{ [mm]} \text{ for compressed air drilled holes}$$

$$c_{\min} = 30 + 0,06 l_v \geq 2\phi \text{ [mm]} \text{ for hammer drilled holes}$$

$$c_{\min} = 30 + 0,02 l_v \geq 2\phi \text{ [mm]} \text{ if a drilling aid is used}$$

5.3 Hole cleaning

The holes should be blown out using compressed, oil free air. Extension tubes and air nozzles directing the air to the hole walls should be used, if holes are deeper than 250mm.



Deeper holes than 250mm should as well be brushed by machine brushing using steel brushes and brush extensions:



Screw the round steel brush HIT-RB to the end of the brush extension(s) HIT-RBS, so that the overall length of the brush is sufficient to reach the base of the borehole. Attach the other end of the extension to the TE-C/TE-Y chuck.

The rebar approvals (ETA) give detailed information on the cleaning procedure for each product.

The following figure underlines the importance of adequate hole cleaning: For drilled holes cleaned according to the instruction, the post-installed bar (blue line) shows higher stiffness and higher resistance than the equivalent cast-in bar. With substandard cleaning (red line), however, stiffness and resistance are clearly below those of the cast-in bar.

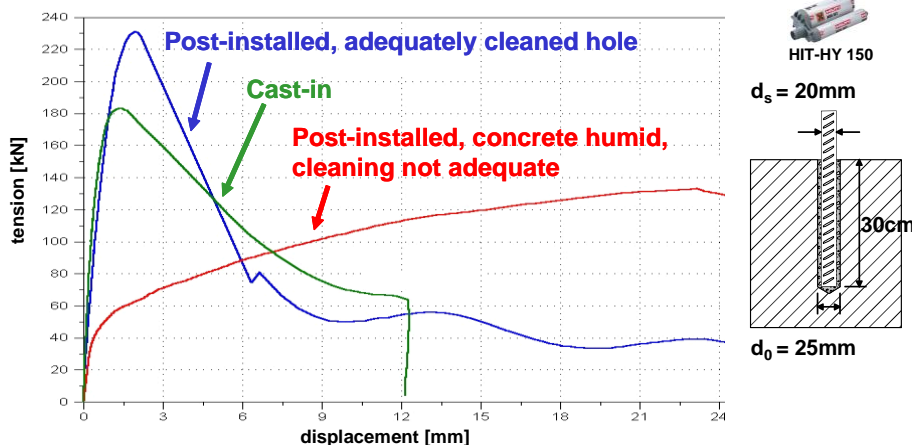

5.4 Injection and bar installation

It is important that air bubbles are avoided during the injection of the adhesive: when the bar is installed later, the air will be compressed and may eject part of the adhesive from the hole when the pressure exceeds the resistance of the liquid adhesive, thus endangering the installer. Moreover, the presence of air may prevent proper curing of the adhesive.

In order to reach the bottom of the drilled holes, mixer extensions shall be used. The holes should be filled with HIT to about 2/3. Marking the extension tubes at 1/3 of the hole length from the tip will help to dispense the correct amount of adhesive. Piston plugs ensure filling of the holes without air bubbles.

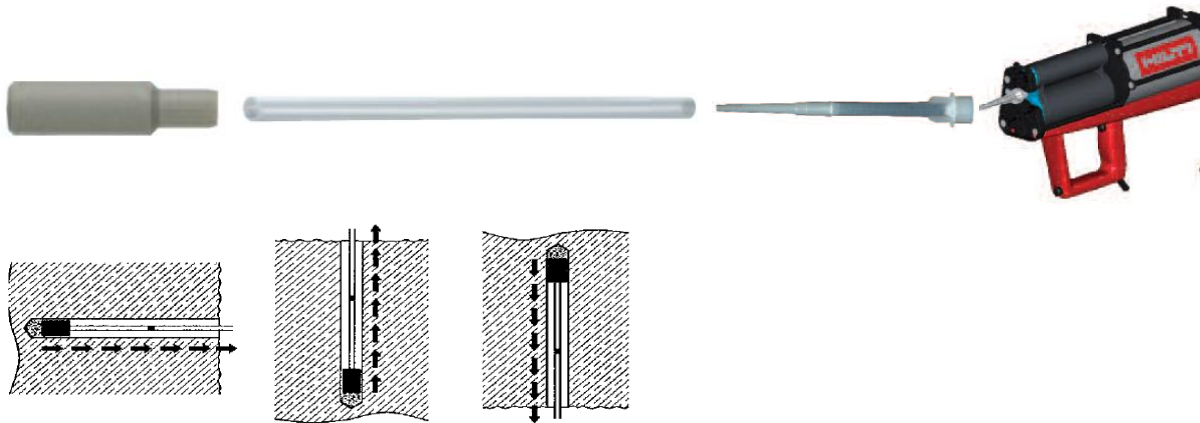

After injecting the HIT, the rebars should be inserted into the hole with a slight rotating movement. When rebars are installed overhead, dripping cups OHC can be used to prevent excess HIT from falling downward in an uncontrolled manner.



5.5 Installation instruction

For correct installation and the linked products, please refer to the detailed "Hilti HIT Installation guide for fastenings in concrete", Hilti Corp., Schaan W3362 1007 as well as to the product specific rebar approvals.

5.6 Mortar consumption estimation for post-installed rebars

Hilti supplies a perfectly matched, quick and easy system for making reliable post-installed rebar connections. When embedment depth and rebar diameter are known, just calculate the number of Hilti HIT cartridges needed.

In the following table please find the quantity of mortar required for one fastening point, in ml. In this estimation, we consider 80% of the mortar is used for fastening, the rest being used for the first pull outs and waste.

The greyed area should not be used since it is not in accordance with the design codes requiring a depth of at least 10 drilling diameters.

Mortar consumption estimation for post-installed rebars (in ml)

Rebar \varnothing d_s [mm]	8	10	12	14	16	18	20	22	24
Drill bit \varnothing d_0 [mm]	12	14	16	18	20	22	25	28	32
Hole depth [mm]									
100	8,0	9,6	11,2	12,8	14,3	15,9	22,2	29,3	43,4
120	9,6	11,5	13,4	15,3	17,2	19,1	26,6	35,2	52,1
140	11,2	13,4	15,6	17,8	20,1	22,3	31,0	41,1	60,8
160	12,8	15,3	17,9	20,4	22,9	25,5	35,4	46,9	69,5
180	14,4	17,2	20,1	22,9	25,8	28,6	39,9	52,8	78,2
200	16,0	19,2	22,3	25,5	28,7	31,8	44,3	58,7	86,9
240	19,2	23,0	26,8	30,6	34,4	38,2	53,2	70,4	104,2
260	20,8	24,9	29,0	33,1	37,3	41,4	57,6	76,3	112,9
280	22,4	26,8	31,3	35,7	40,1	44,6	62,0	82,1	121,6
300	24,0	28,7	33,5	38,2	43,0	47,7	66,5	88,0	130,3
320	25,6	30,7	35,7	40,8	45,9	50,9	70,9	93,9	139,0
340	27,2	32,6	38,0	43,3	48,7	54,1	75,3	99,7	147,7
360	28,8	34,5	40,2	45,9	51,6	57,3	79,8	105,6	156,4
380	30,4	36,4	42,4	48,4	54,5	60,5	84,2	111,5	165,1
400	32,0	38,3	44,7	51,0	57,3	63,7	88,6	117,3	173,7
450	36,0	43,1	50,2	57,4	64,5	71,6	99,7	132,0	195,5
500	40,0	47,9	55,8	63,7	71,7	79,6	110,8	146,7	217,2
550	44,0	52,7	61,4	70,1	78,8	87,5	121,8	161,3	238,9
600	48,0	57,5	67,0	76,5	86,0	95,5	132,9	176,0	260,6
650	52,0	62,3	72,6	82,9	93,1	103,4	144,0	190,7	282,3
700	56,0	67,1	78,1	89,2	100,3	111,4	155,1	205,3	304,0
750	60,0	71,9	83,7	95,6	107,5	119,4	166,1	220,0	325,8
800	64,0	76,6	89,3	102,0	114,6	127,3	177,2	234,7	347,5
850	68,0	81,4	94,9	108,3	121,8	135,3	188,3	249,3	369,2
900	72,0	86,2	100,5	114,7	129,0	143,2	199,4	264,0	390,9
950	76,0	91,0	106,1	121,1	136,1	151,2	210,4	278,7	412,6
1000	80,0	95,8	111,6	127,5	143,3	159,1	221,5	293,3	434,3
1200	96,0	115,0	134,0	153,0	172,0	191,0	265,8	352,0	521,2
1400	111,9	134,1	156,3	178,4	200,6	222,8	310,1	410,7	608,1
1600	127,9	153,3	178,6	203,9	229,3	254,6	354,4	469,3	694,9
1800	143,9	172,4	200,9	229,4	257,9	286,4	398,7	528,0	781,8
2000	159,9	191,6	223,3	254,9	286,6	318,3	443,0	586,7	868,7
2500	199,9	239,5	279,1	318,7	358,2	397,8	553,8	733,3	1085,8
3000	239,9	287,4	334,9	382,4	429,9	477,4	664,6	880,0	1303,0
3200	255,9	306,5	357,2	407,9	458,5	509,2	708,9	938,7	1389,9

25	26	28	30	32	34	36	40	Rebar \varnothing d_s [mm]
32	35	35	37	40	45	45	55	Drill bit \varnothing d_0 [mm]
								Hole depth [mm]
38,8	53,1	42,9	45,6	55,8	83,6	70,4	136,4	100
46,6	63,7	51,5	54,7	67,0	100,3	84,5	163,7	120
54,3	74,3	60,0	63,8	78,1	117,0	98,6	190,9	140
62,1	84,9	68,6	73,0	89,3	133,8	112,7	218,2	160
69,9	95,5	77,2	82,1	100,4	150,5	126,7	245,5	180
77,6	106,1	85,8	91,2	111,6	167,2	140,8	272,8	200
93,2	127,4	102,9	109,4	133,9	200,6	169,0	327,3	240
100,9	138,0	111,5	118,6	145,1	217,4	183,1	354,6	260
108,7	148,6	120,1	127,7	156,2	234,1	197,1	381,9	280
116,5	159,2	128,7	136,8	167,4	250,8	211,2	409,1	300
124,2	169,8	137,2	145,9	178,6	267,5	225,3	436,4	320
132,0	180,4	145,8	155,0	189,7	284,3	239,4	463,7	340
139,7	191,0	154,4	164,2	200,9	301,0	253,5	491,0	360
147,5	201,7	163,0	173,3	212,0	317,7	267,6	518,3	380
155,3	212,3	171,6	182,4	223,2	334,4	281,6	545,5	400
174,7	238,8	193,0	205,2	251,1	376,2	316,8	613,7	450
194,1	265,3	214,4	228,0	279,0	418,0	352,0	681,9	500
213,5	291,9	235,9	250,8	306,9	459,8	387,2	750,1	550
232,9	318,4	257,3	273,6	334,8	501,6	422,4	818,3	600
252,3	344,9	278,8	296,4	362,7	543,4	457,6	886,5	650
271,7	371,5	300,2	319,2	390,6	585,2	492,9	954,7	700
291,1	398,0	321,7	342,0	418,5	627,0	528,1	1022,9	750
310,5	424,5	343,1	364,8	446,4	668,8	563,3	1091,0	800
329,9	451,1	364,5	387,6	474,3	710,6	598,5	1159,2	850
349,3	477,6	386,0	410,4	502,2	752,4	633,7	1227,4	900
368,7	504,1	407,4	433,2	530,1	794,2	668,9	1295,6	950
388,2	530,7	428,9	456,0	558,0	836,0	704,1	1363,8	1000
465,8	636,8	514,6	547,2	669,6	1003,2	844,9	1636,6	1200
543,4	742,9	600,4	638,4	781,2	1170,4	985,7	1909,3	1400
621,0	849,0	686,2	729,6	892,8	1337,6	1126,5	2182,1	1600
698,7	955,2	772,0	820,8	1004,4	1504,8	1267,3	2454,9	1800
776,3	1061,3	857,7	912,0	1116,0	1672,0	1408,1	2727,6	2000
970,4	1326,6	1072,2	1140,0	1395,0	2090,0	1760,2	3409,5	2500
1164,5	1592,0	1286,6	1368,0	1674,0	2508,1	2112,2	4091,4	3000
1242,1	1698,1	1372,4	1459,2	1785,6	2675,3	2253,0	4364,2	3200

Hilti HIT-RE 500-SD mortar with rebar (as post-installed connection)

Injection mortar system	Benefits
 <p data-bbox="810 524 1002 752">Hilti HIT-RE 500-SD 330 ml foil pack (also available as 500 ml and 1400 ml foil pack)</p> <p data-bbox="810 853 954 880">Statik mixer</p> <p data-bbox="810 972 884 999">Rebar</p>	<ul style="list-style-type: none"> - SAFEset technology: drilling and borehole cleaning in one step with Hilti hollow drill bit - suitable for concrete C 12/15 to C 50/60 - high loading capacity - suitable for dry and water saturated concrete - for rebar diameters up to 40 mm - non corrosive to rebar elements - long working time at elevated temperatures - odourless epoxy - suitable for embedment length till 3200 mm

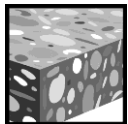

Concrete



Fire
resistance



Diamond
drilled
holes



European
Technical
Approval



Corossion
tested



PROFIS
Rebar design
software



Hilti **SAFEset**
technology with
hollow drill bit

Service temperature range

Temperature range: -40°C to +80°C (max. long term temperature +50°C, max. short term temperature +80°C).

Approvals / certificates

Description	Authority / Laboratory	No. / date of issue
European technical approval	DIBt, Berlin	ETA-09/0295 / 2013-05-09
Application document	CSTB, Marne la Vallée	DTA-3/10-649 / 2010-06-17
European technical approval	DIBt, Berlin	ETA-07/0260 / 2013-06-26
Assessment	MFPA Leipzig GmbH	GS 3.2/09-122 / 2010-05-26

^{a)} All data given in this section according to the approvals mentioned above, ETA-09/0295 issue 2013-05-09 and ETA-07/0260 issue 2013-06-26.

Materials

Reinforcement bars according to EC2 Annex C Table C.1 and C.2N.

Properties of reinforcement

Product form		Bars and de-coiled rods	
Class		B	C
Characteristic yield strength f_{yk} or $f_{0,2k}$ (MPa)		400 to 600	
Minimum value of $k = (f_t/f_y)_k$		$\geq 1,08$	$\geq 1,15$ < 1,35
Characteristic strain at maximum force, ϵ_{uk} (%)		$\geq 5,0$	$\geq 7,5$
Bendability		Bend / Rebend test	
Maximum deviation from nominal mass (individual bar) (%)	Nominal bar size (mm) ≤ 8	$\pm 6,0$	
	> 8	$\pm 4,5$	
Bond: Minimum relative rib area, $f_{R,min}$	Nominal bar size (mm) 8 to 12	0,040	
	> 12	0,056	

Setting details

For detailed information on installation see instruction for use given with the package of the product.

Curing time for general conditions



Data according ETA-09/0295, issue 2013-05-09			
Temperature of the base material	Working time in which rebar can be inserted and adjusted t_{gel}	Initial curing time $t_{cure,ini}$	Curing time before rebar can be fully loaded t_{cure}
$5\text{ °C} \leq T_{BM} < 10\text{ °C}$	2 h	18 h	72 h
$10\text{ °C} \leq T_{BM} < 15\text{ °C}$	90 min	12 h	48 h
$15\text{ °C} \leq T_{BM} < 20\text{ °C}$	30 min	9 h	24 h
$20\text{ °C} \leq T_{BM} < 25\text{ °C}$	20 min	6 h	12 h
$25\text{ °C} \leq T_{BM} < 30\text{ °C}$	20 min	5 h	12 h
$30\text{ °C} \leq T_{BM} < 40\text{ °C}$	12 min	4 h	8 h
$T_{BM} = 40\text{ °C}$	12 min	4 h	4 h

For dry concrete curing times may be reduced according to the following table. For installation temperatures below +5 °C all load values have to be reduced according to the load reduction factors given below.

Curing time for dry concrete

Additional Hilti technical data				
Temperature of the base material	Working time in which rebar can be inserted and adjusted t_{gel}	Initial curing time $t_{cure,ini}$	Reduced curing time before rebar can be fully loaded t_{cure}	Load reduction factor
$T_{BM} = -5\text{ °C}$	4 h	36 h	72 h	0,6
$T_{BM} = 0\text{ °C}$	3 h	25 h	50 h	0,7
$T_{BM} = 5\text{ °C}$	2 ½ h	18 h	36 h	1
$T_{BM} = 10\text{ °C}$	2 h	12 h	24 h	1
$T_{BM} = 15\text{ °C}$	1 ½ h	9 h	18 h	1
$T_{BM} = 20\text{ °C}$	30 min	6 h	12 h	1
$T_{BM} = 30\text{ °C}$	20 min	4 h	8 h	1
$T_{BM} = 40\text{ °C}$	12 min	2 h	4 h	1

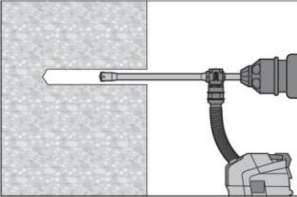
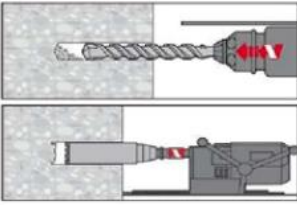
Setting instruction

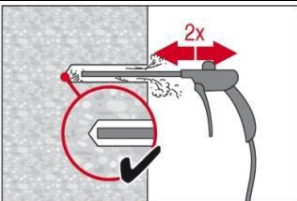
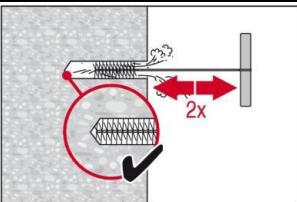
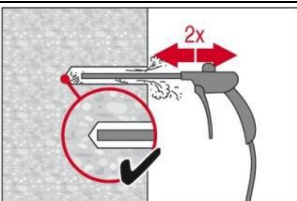
<p>Safety Regulations:</p> 	<p>Review the Material Safety Data Sheet (MSDS) before use for proper and safe handling! Wear well-fitting protective goggles and protective gloves when working with Hilti HIT-RE 500-SD. Important: Observe the installation instruction of the manufacturer provided with each foil pack.</p>
<p>1. Drill hole</p>	<p>Note: Before drilling, remove carbonized concrete; clean contact areas (see Annex B1) In case of aborted drill hole the drill hole shall be filled with mortar.</p>
	<p>Drill hole to the required embedment depth with an appropriately sized Hilti TE-CD or TE-YD hollow drill bit with Hilti vacuum attachment. This drilling system removes the dust and cleans the bore hole during drilling when used in accordance with the user's manual. After drilling is complete, proceed to the "injection preparation" step in the instructions for use.</p>
	<p>Drill the hole to the required embedment depth using a hammer-drill with carbid drill bit set in rotation hammer mode, a compressed air drill or a diamond core machine.</p> <p>Hammer drill (HD) Compressed air drill (CA) Diamond core wet (DD) and dry (PCC)</p> 
<p>3. Bore hole cleaning</p>	<p>(Not needed with Hilti TE-CD and Hilti TE-YD drill bit) The borehole must be free of dust, debris, water, ice, oil, grease and other contaminants prior to mortar injection.</p> <p>Just before setting an anchor, the bore hole must be free of dust and debris by one of two cleaning methods described below</p>
<p>Compressed air cleaning (CAC)</p>	
	<p>Blowing 2 times from the back of the hole with oil-free compressed air (min. 6 bar at 100 litres per minute (LPM)) until return air stream is free of noticeable dust. Bore hole diameter ≥ 32 mm the compressor must supply a minimum air flow of 140 m³/hour. If required use additional accessories and extensions for air nozzle and brush to reach back of hole.</p>
	<p>Brushing 2 times with the specified brush HIT-RB size (brush $\varnothing \geq$ borehole \varnothing) by inserting the round steel brush to the back of the hole in a twisting motion. The brush shall produce natural resistance as it enters the anchor hole. If this is not the case, please use a new brush or a brush with a larger diameter.</p>
	<p>Blowing 2 times again with compressed air until return air stream is free of noticeable dust. If required use additional accessories and extensions for air nozzle and brush to reach back of hole.</p>



Deep boreholes – Blowing

For boreholes deeper than 250mm (for $\varnothing=8\text{mm} - 12\text{mm}$) or deeper than $20 \varnothing$ (for $\varnothing>12\text{mm}$) use the appropriate air nozzle Hilti HIT-DL

Safety tip: Do not inhale concrete dust.

The application of the dust collector Hilti HIT-DRS is recommended.

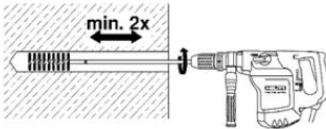

Deep boreholes – Brushing

For boreholes deeper than 250 mm (for $\varnothing=8\text{mm} - 12\text{mm}$) or deeper than $20 \varnothing$ (for $\varnothing>12\text{mm}$) use machine brushing and brush extensions HIT-RBS.

Screw the round steel brush HIT-RB in one end of the brush extension(s) HIT-RBS, so that the overall length of the brush is sufficient to reach the base of the borehole. Attach the other end of the extension to the TE-C/TE-Y chuck.

Safety tip:

- Start machine brushing operational slowly.
- Start brushing operation once brush is inserted in borehole.

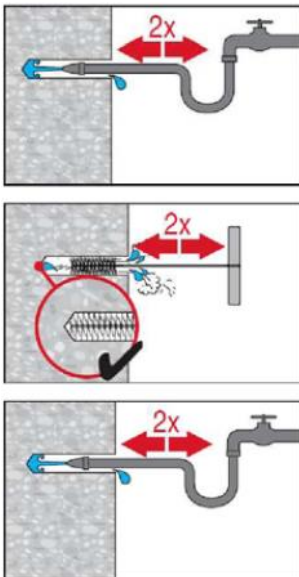

In addition for wet diamond coring (DD):

For wet diamond coring please observe the following steps in addition **prior to** compressed air cleaning:

Remove all core fragments from the anchor hole. Flush the anchor hole with clear running water until water runs clear. Brush the anchor hole again 2 times with the appropriate sized brush over the entire depth of the anchor hole. Repeat the flushing process until water runs out of the anchor hole.

Manual Cleaning (MC) Manual cleaning is permitted for hammer drilled boreholes up to hole diameters $d_0 \leq 20\text{mm}$ and depths l_v resp. $l_{e,ges.} \leq 160\text{mm}$.

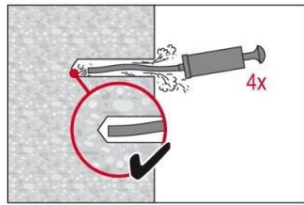

Blowing

4 strokes with Hilti blow-out pump from the back of the hole until return air stream is free of noticeable dust.

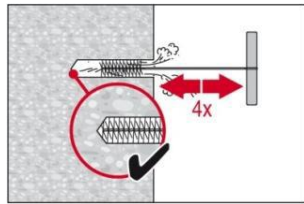

Brushing

4 times with the specified brush HIT_RB size (brush $\varnothing \geq$ borehole \varnothing) by inserting the round steel wire brush to the back of the hole with a twisting motion. The brush shall produce natural resistance as it enters the anchor hole. If this is not the case, please use a new brush or a brush with a larger diameter.

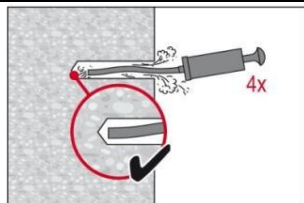

Blowing

4 strokes with Hilti blow-out pump from the back of the hole until return air stream is free of noticeable dust.



Manual Cleaning (MC)

Hilti hand pump recommended for blowing out bore hole with diameters $d < 20\text{mm}$ and bore hole depth $h_0 < 160\text{mm}$

3.Rebar preparation and foil pack preparation

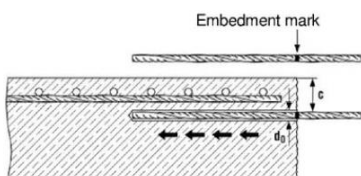

Before use, make sure the rebar is dry and free of oil or other residue.

Mark the embedment depth on the rebar. (e.g. with tape), l_v

Insert rebar in borehole, to verify hole and setting depth l_v resp. $l_{e,ges}$

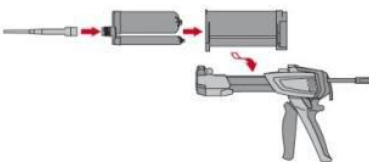

- Observe the Instruction for Use of the dispenser and the mortar.
- Tightly attach Hilti HIT-RE-M mixing nozzle to foil pack manifold.
- Insert foil pack into foil pack holder and swing holder into the dispenser.

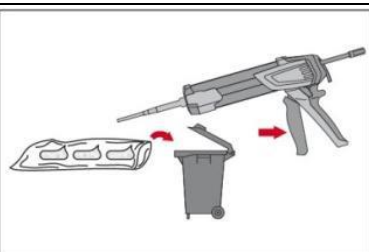

Discard initial mortar. The foil pack opens automatically as dispensing is initiated. Depending on the size of the foil pack an initial amount of adhesive has to be discarded.

After changing a mixing nozzle, the first few trigger pulls must be discarded as described above. For each new foil pack a new mixing nozzle must be used.

Discard quantities are

- 3 strokes for 330 ml foil pack,
- 4 strokes for 500 ml foil pack,
- 65 ml for 1400 ml foil pack,

4.Inject mortar into borehole Forming air pockets be avoided

4.1 Injection method for borehole depth ≤ 250 mm

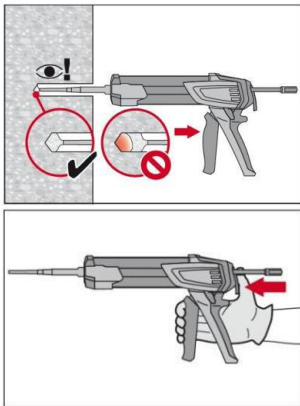

Inject the mortar from the back of the hole towards the front and slowly withdraw the mixing nozzle step by step after each trigger pull.

Fill holes approximately 2/3 full, or as required to ensure that the annular gap between the rebar and the concrete is completely filled with adhesive over the embedment length.

After injecting, depressurize the dispenser by pressing the release trigger. This will prevent further mortar discharge from the mixing nozzle.

4.2 Injection method for borehole depth > 250 mm or overhead application

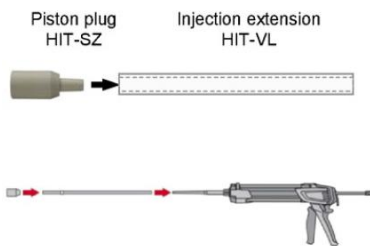

Assemble mixing nozzle HIT-RE-M, extension(s) and piston plug HIT-SZ.

For combinations of several injection extensions use coupler HIT-VL K. A substitution of the injection extension for a plastic hose or a combination of both is permitted.

The combination of HIT-SZ piston plug with HIT-VL 16 pipe and then HIT-VL 16 tube support proper injection.

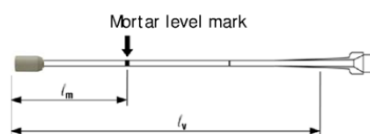

Mark the required mortar level l_m and embedment depth l_b resp.

$l_{e,ges}$ with tape or marker on the injection extension.

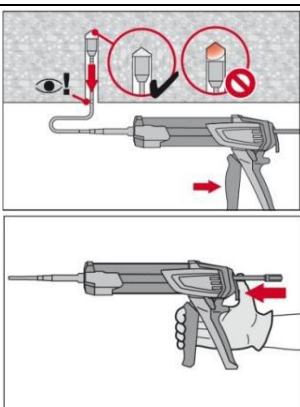

Insert piston plug to back of the hole. Begin injection allowing the pressure of the injected adhesive mortar to push the piston plug towards the front of the hole.

Fill holes approximately 2/3 full, or as required to ensure that the annular gap between the rebar and the concrete is completely filled with adhesive over the embedment length.

Injection until the mortar level mark l_m becomes visible.

After injecting, depressurize the dispenser by pressing the release trigger. This will prevent further mortar discharge from the mixing nozzle.

5. Insert rebar

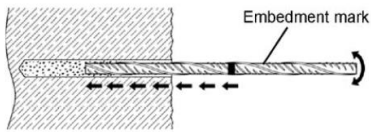

For easy installation insert the rebar slowly twisted into the borehole until the embedment mark is at the concrete surface level.

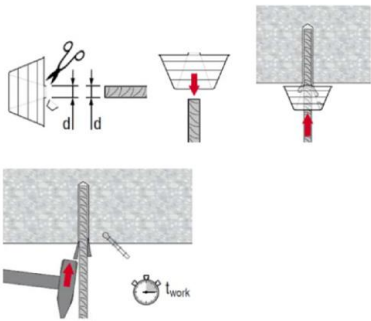

Overhead application:

During insertion of the rebar, mortar might flow out of the borehole. For collection of the flowing mortar, HIT-OHC may be used.

Support the rebar and secure it from falling till mortar started to harden, e.g. using wedges HIT-OHW.

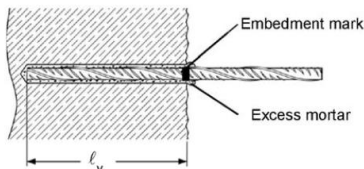

After installing the rebar the annular gap must be completely filled with mortar.

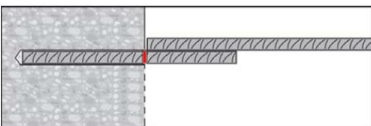

After installing the rebar the annular gap must be completely filled with mortar.

Proper installation can be verified when:

Desired anchoring embedment is reached l_v : embedment mark at concrete surface.

Excess mortar flows out of the borehole after the rebar has been fully inserted until the embedment mark.

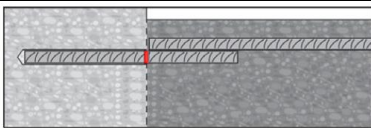

Full load may be applied only after the curing time " t_{cure} " has elapsed.

Fitness for use

Some creep tests have been conducted in accordance with ETAG guideline 001 part 5 and TR 023 in the following conditions : in dry environment at 50 °C during 90 days.

These tests show an excellent behaviour of the post-installed connection made with HIT-RE 500-SD: low displacements with long term stability, failure load after exposure above reference load.

Resistance to chemical substances

Categories	Chemical substances	Resistant	Non resistant
Alkaline products	Drilling dust slurry pH = 12,6	+	
	Potassium hydroxide solution (10%) pH = 14	+	
Acids	Acetic acid (10%)		+
	Nitric acid (10%)		+
	Hydrochloric acid (10%)		+
	Sulfuric acid (10%)		+
Solvents	Benzyl alcohol		+
	Ethanol		+
	Ethyl acetate		+
	Methyl ethyl keton (MEK)		+
	Trichlor ethylene		+
	Xylol (mixture)	+	
Products from job site	Concrete plasticizer	+	
	Diesel	+	
	Engine oil	+	
	Petrol	+	
	Oil for form work	+	
Environnement	Sslt water	+	
	De-mineralised water	+	
	Sulphurous atmosphere (80 cycles)	+	

Electrical Conductivity

HIT-RE 500-SD in the hardened state **is not conductive electrically**. Its electric resistivity is $66 \cdot 10^{12} \Omega \cdot m$ (DIN IEC 93 – 12.93). It is adapted well to realize electrically insulating anchorings (ex: railway applications, subway).

Drilling diameters

Rebar (mm)	Drill bit diameters d_0 [mm]			
	Hammer drill (HD) Hollow Drill Bit (HDB)	Compressed air drill (CA)	Diamond coring	
			Wet (DD)	Dry (PCC)
8	12 (10 ^{a)})	-	12 (10 ^{a)})	-
10	14 (12 ^{a)})	-	14 (12 ^{a)})	-
12	16 (14 ^{a)})	17	16 (14 ^{a)})	-
14	18	17	18	-
16	20	20	20	-
18	22	22	22	-
20	25	26	25	-
22	28	28	28	-
24	32	32	32	35
25	32	32	32	35
26	35	35	35	35
28	35	35	35	35
30	37	35	37	35
32	40	40	40	47
34	45	42	42	47
36	45	45	47	47
40	55	57	52	52

a) Max. installation length $l = 250$ mm.

Basic design data for rebar design according to rebar ETA

Bond strength in N/mm² according to ETA 09/0295 for good bond conditions for hammer drilling, compressed air drilling, dry diamond core drilling

Rebar (mm)	Concrete class								
	C12/15	C16/20	C20/25	C25/30	C30/37	C35/45	C40/50	C45/55	C50/60
8 - 32	1,6	2,0	2,3	2,7	3,0	3,4	3,7	4,0	4,3
34	1,6	2,0	2,3	2,6	2,9	3,3	3,6	3,9	4,2
36	1,5	1,9	2,2	2,6	2,9	3,3	3,6	3,8	4,1
40	1,5	1,8	2,1	2,5	2,8	3,1	3,4	3,7	4,0

Bond strength in N/mm² according to ETA 09/0295 for good bond conditions for wet diamond core drilling

Rebar (mm)	Concrete class								
	C12/15	C16/20	C20/25	C25/30	C30/37	C35/45	C40/50	C45/55	C50/60
8 - 25	1,6	2,0	2,3	2,7	3,0	3,4	3,7	4,0	4,3
26 - 32	1,6	2,0	2,3	2,7	2,7	2,7	2,7	2,7	2,7
34	1,6	2,0	2,3	2,6	2,6	2,6	2,6	2,6	2,6
36	1,5	1,9	2,2	2,6	2,6	2,6	2,6	2,6	2,6
40	1,5	1,8	2,1	2,5	2,5	2,5	2,5	2,5	2,5

Pullout design bond strength for Hit Rebar design

Design bond strength in N/mm² according to ETA 07/0260 (values in table are design values, $f_{bd,po} = \tau_{Rk}/\gamma_{Mp}$)

Hammer or compressed air drilling.
Water saturated, water filled or submerged hole.
Uncracked concrete C20/25.

temperature range	Bar diameter															
	Data according to ETA 04/0027												Hilti tech data			
	8	10	12	14	16	20	22	24	25	26	28	30	32	36	40	
I: 40°C/24°C	7,1			6,7			6,2						5,2	4,8		
II: 58°C/35°C	5,7				5,2				4,8				4,3	3,8		
III: 70°C/43°C	3,3					3,1					2,9				2,4	

Increasing factor in non-cracked concrete: $f_{B,p} = (f_{cck}/25)^{0,1}$ (f_{cck} : characteristic compressive strength on cube)

Additional Hilti Technical Data:

If the concrete is dry (not in contact with water before/during installation and curing), the pullout design bond strength may be increased by 20%.

If the hole was produced by wet diamond coring, the pullout design bond strength has to be reduced by 30%.

Reduction factor for splitting with large concrete cover: $\delta = 0,306$ (Hilti additional data)

Fire Resistance

according to MFPA Leipzig, report **GS 3.2/09-122**

a) fire situation “anchorage”

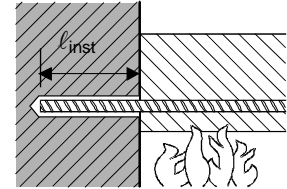

Maximum force in rebar in conjunction with HIT-RE 500 SD as a function of embedment depth for the fire resistance classes F30 to F240 (yield strength $f_{yk} = 500 \text{ N/mm}^2$) according EC2^{a)}.

Bar \varnothing [mm]	Drill hole \varnothing [mm]	Max. $F_{s,T}$ [kN]	l_{inst} [mm]	Fire resistance of bar in [kN]					
				R30	R60	R90	R120	R180	R240
8	10	16,19	65	1,38	0,57	0,19	0,05	0	0
			80	2,35	1,02	0,47	0,26	0	0
			95	3,87	1,68	0,88	0,55	0,12	0
			115	7,30	3,07	1,71	1,14	0,44	0,18
			150	16,19	8,15	4,59	3,14	1,41	0,8
			180		16,19	9,99	6,75	2,94	1,7
			205			16,19	12,38	5,08	2,86
			220				16,19	6,95	3,82
			265					16,19	8,57
			305					16,19	
10	12	25,29	80	2,94	1,27	0,59	0,33	0	0
			100	5,68	2,45	1,31	0,85	0,24	0
			120	10,66	4,44	2,48	1,68	0,68	0,31
			140	17,57	7,76	4,38	2,99	1,33	0,73
			165	25,29	15,06	8,5	5,79	2,58	1,5
			195		25,29	17,63	12,18	5,12	2,93
			220			25,29	20,66	8,69	4,78
			235				25,29	11,8	6,30
			280					25,29	13,86
			320				25,29		
12	16	36,42	95	5,80	2,52	1,32	0,83	0,18	0
			120	12,79	5,33	2,97	2,01	0,82	0,37
			145	23,16	10,68	6,02	4,12	1,84	1,03
			180	36,42	24,29	14,99	10,12	4,41	2,55
			210		36,42	27,38	20,65	8,47	4,74
			235			36,42	31,01	14,16	7,56
			250				36,42	19,13	9,89
			295					36,42	21,43
			335				36,42		
14	18	49,58	110	10,92	4,65	2,55	1,70	0,61	0,20
			140	24,60	10,87	6,13	4,19	1,86	1,03
			170	39,12	23,50	13,55	9,20	4,07	2,37
			195	49,58	35,6	24,69	17,05	7,17	4,10
			225		49,58	39,20	31,34	13,48	7,34
			250			49,58	43,44	22,32	11,54
			265				49,58	29,49	15,00
			310					49,58	31,98
			350				49,58		

Bar \varnothing [mm]	Drill hole \varnothing [mm]	Max. $F_{s,T}$ [kN]	l_{inst} [mm]	Fire resistance of bar in [kN]					
				R30	R60	R90	R120	R180	R240
16	20	64,75	130	22,59	9,42	5,30	3,61	1,56	0,80
			160	39,17	21,33	11,95	8,15	3,65	2,11
			190	55,76	37,92	24,45	17,25	7,35	4,22
			210	64,75	48,98	36,51	27,53	11,29	6,32
			240		64,75	53,10	44,12	20,88	11,04
			265			64,75	57,94	33,7	17,14
			280				64,75	42,0	22,17
			325					64,75	44,84
			365						64,75
20	25	101,18	160	48,97	26,67	14,93	10,18	4,56	2,64
			200	76,61	54,31	38,73	27,5	11,42	6,48
			240	101,18	81,96	66,37	55,15	26,10	13,8
			270		101,18	87,11	75,88	45,58	23,36
			295			101,18	93,16	62,86	35,72
			310				101,18	73,23	45,69
			355					101,18	76,79
			395						101,18
25	30	158,09	200	95,77	67,89	48,41	34,37	14,27	8,10
			250	138,96	111,09	91,60	77,51	39,86	20,61
			275	158,09	132,69	113,2	99,17	61,30	31,81
			305		158,09	139,12	125,09	87,22	52,79
			330			158,09	146,69	108,82	74,39
			345				158,09	121,77	87,34
			390					158,09	126,22
			430						158,09
32	40	259,02	255	183,40	147,72	122,78	104,82	56,35	28,80
			275	205,52	169,84	144,90	126,94	78,46	40,71
			325	259,02	225,13	200,19	182,23	133,75	89,68
			368		259,02	238,89	220,93	172,46	128,39
			380			259,02	243,05	194,58	150,51
			395				259,02	211,16	167,09
			440					259,02	216,86
			480						259,02
36	42 - 46	327,82	290	249,87	209,73	181,67	161,46	106,93	59,10
			325	293,41	253,27	225,21	205,01	150,47	100,89
			355	327,82	290,59	262,54	242,33	187,80	138,22
			385		327,82	299,86	279,65	225,12	175,54
			410			327,82	310,75	256,22	206,64
			425				327,82	274,88	225,30
			470					327,82	281,28
			510						327,82
40	47	404,71	320	319,10	274,50	243,33	220,87	160,28	105,19
			355	367,48	322,88	291,71	269,25	208,66	153,57
			385	404,71	364,35	333,18	310,72	250,13	195,04
			415		404,71	374,64	352,19	291,60	236,51
			440			404,71	386,75	326,16	271,07
			455				404,71	346,89	291,80
			500					404,71	354,01
			540						404,71

b) bar connection parallel to slab or wall surface exposed to fire

Max. bond stress, τ_T , depending on actual clear concrete cover for classifying the fire resistance.

It must be verified that the actual force in the bar during a fire, $F_{s,T}$, can be taken up by the bar connection of the selected length, l_{inst} . Note: Cold design for ULS is mandatory.

$$F_{s,T} \leq (l_{inst} - c_f) \cdot \phi \cdot \pi \cdot \tau_T \quad \text{where: } (l_{inst} - c_f) \geq l_s;$$

l_s = lap length

ϕ = nominal diameter of bar

$l_{inst} - c_f$ = selected overlap joint length; this must be at least l_s ,
but may not be assumed to be more than 80ϕ

τ_T = bond stress when exposed to fire

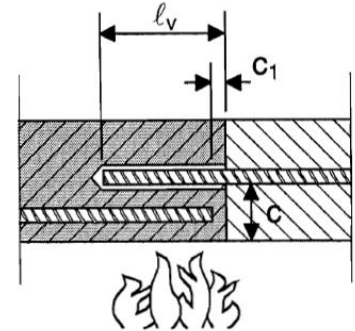

Critical temperature-dependent bond stress, τ_c , concerning “overlap joint” for Hilti HIT-RE 500-SD injection adhesive in relation to fire resistance class and required minimum concrete coverage c.

Clear concrete cover c [mm]	Max. bond stress, τ_c [N/mm ²]					
	R30	R60	R90	R120	R180	R240
10	0	0	0	0	0	0
20	0,49					
30	0,66					
40	0,89					
50	1,21					
60	1,63	0,80	0,51	0,49	0,45	0
70	2,19	1,04	0,65			
80	2,96	1,35	0,83	0,61	0,55	
90	3,99	1,75	1,06	0,77		
100	5,38	2,26	1,36	0,97	0,67	
110	7,25	2,93	1,73	1,23	0,81	0,55
120	9,78	3,79	2,21	1,55	0,98	0,64
130	11,00	4,91	2,81	1,96	1,18	0,76
140		6,35	3,59	2,47	1,43	0,89
150		8,22	4,58	3,12	1,73	1,04
160		10,65	5,84	3,94	2,10	1,23
170		11,00	7,45	4,97	2,54	1,44
180			9,51	6,27	3,07	1,69
190			11,00	7,91	3,71	1,99
200				9,99	4,49	2,34
210			11,00	11,00	11,00	5,44
220		6,58				3,22
230	7,96	3,79				
240	9,64	4,45				
250	11,00	5,23				
260		6,14				
270		7,21				
280		8,47				
290		9,95				
300	11,00	11,00				
310		11,00				

Basic design data for seismic rebar design

Bond strength $f_{bd,seism}$ in N/mm² according to DTA-3/10-649 for good bond conditions for hammer drilling, compressed air drilling, dry diamond core drilling

Rebar (mm)	Concrete class					
	C20/25	C25/30	C30/37	C35/45	C40/50	C45/55
8	2,3	2,7	3,0	3,4	3,7	4,0
10	2,3	2,7	3,0	3,4	3,7	4,0
12	2,3	2,7	3,0	3,4	3,7	3,7
14	2,3	2,7	3,0	3,4	3,7	3,7
16	2,3	2,7	3,0	3,4	3,7	3,7
18	2,3	2,7	3,0	3,4	3,7	3,7
20	2,3	2,7	3,0	3,4	3,7	3,7
22	2,3	2,7	3,0	3,0	3,4	3,4
24	2,3	2,7	3,0	3,0	3,4	3,4
25	2,3	2,7	3,0	3,0	3,4	3,4
26	2,3	2,7	3,0	3,0	3,0	3,0
28	2,3	2,7	3,0	3,0	3,0	3,0
30	2,3	2,7	3,0	3,0	3,0	3,0
32	2,3	2,7	3,0	3,0	3,0	3,0
34	2,3	2,6	2,9	2,7	2,7	2,7
36	2,2	2,6	2,9	2,7	2,7	2,7
40	2,1	2,5	2,7	2,7	2,7	2,7

Minimum anchorage length



The multiplication factor for minimum anchorage length shall be considered as 1,0 for all drilling methods.

Minimum anchorage and lap lengths for C20/25; maximum hole lengths (ETA 09/0295)

Rebar		Hammer drilling, Compressed air drilling, Dry diamond coring drilling		Wet diamond coring drilling		l_{max} [mm]
Diameter d_s [mm]	$f_{y,k}$ [N/mm ²]	$l_{b,min}^*$ [mm]	$l_{o,min}^*$ [mm]	$l_{b,min}^*$ [mm]	$l_{o,min}^*$ [mm]	
8	500	113	200	170	300	1000
10	500	142	200	213	300	1000
12	500	170	200	255	300	1200
14	500	198	210	298	315	1400
16	500	227	240	340	360	1600
18	500	255	270	383	405	1800
20	500	284	300	425	450	2000
22	500	312	330	468	495	2200
24	500	340	360	510	540	2400
25	500	354	375	532	563	2500
26	500	369	390	553	585	2600
28	500	397	420	595	630	2800
30	500	425	450	638	675	3000
32	500	454	480	681	720	3200
34	500	492	510	738	765	3200
36	500	532	540	797	810	3200
40	500	616	621	925	932	3200

$l_{b,min}$ (8.6) and $l_{o,min}$ (8.11) are calculated for good bond conditions with maximum utilisation of rebar yield strength
 $f_{yk} = 500 \text{ N/mm}^2$ and $\alpha_6 = 1,0$

Hilti HIT-RE 500 mortar with rebar (as post-installed connection)

Injection mortar system	Benefits
 <p>Hilti HIT-RE 500 330 ml foil pack (also available as 500 ml and 1400 ml foil pack)</p>	<ul style="list-style-type: none"> - SAFEset technology: drilling and borehole cleaning in one step with Hilti hollow drill bit - suitable for non-cracked concrete C 20/25 to C 50/60 - high loading capacity - suitable for dry and water saturated concrete - under water application - large diameter applications - high corrosion resistant - long working time at elevated temperatures - odourless epoxy
 <p>Static mixer</p>	
 <p>Rebar</p>	

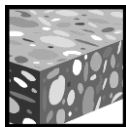

Concrete



Fire
resistance



Diamond
drilled
holes



European
Technical
Approval



DIBt approval



Drinking
water
approved



Corrosion
tested



PROFIS
Rebar design
software



Hilti **SAFEset**
technology with
hollow drill bit

Service temperature range

Temperature range: -40°C to +80°C (max. long term temperature +50°C, max. short term temperature +80°C).

Approvals / certificates

Description	Authority / Laboratory	No. / date of issue
European technical approval	DIBt, Berlin	ETA-08/0105 / 2014-04-30
European technical approval	DIBt, Berlin	ETA-04/0027 / 2013-06-26
DIBt approval	DIBt, Berlin	Z-21.8-1790 / 2009-03-16
Fire test report	IBMB Braunschweig	3357/0550-5 / 2002-07-30
Assessment report (fire)	Warringtonfire	WF 327804/B / 2013-07-10

a) All data given in this section according to the approvals mentioned above, ETA-08/0105 issue on 2014-04-30 and ETA-04/0027 issue on 2013-06-26.

Materials

Reinforcement bars according to EC2 Annex C Table C.1 and C.2N.

Properties of reinforcement

Product form		Bars and de-coiled rods	
Class		B	C
Characteristic yield strength f_{yk} or $f_{0,2k}$ (MPa)		400 to 600	
Minimum value of $k = (f_t/f_y)_k$		$\geq 1,08$	$\geq 1,15$ < 1,35
Characteristic strain at maximum force, ϵ_{uk} (%)		$\geq 5,0$	$\geq 7,5$
Bendability		Bend / Rebend test	
Maximum deviation from nominal mass (individual bar) (%)	Nominal bar size (mm) ≤ 8	$\pm 6,0$	
	> 8	$\pm 4,5$	
Bond: Minimum relative rib area, $f_{R,min}$	Nominal bar size (mm) 8 to 12	0,040	
	> 12	0,056	

Setting details

For detailed information on installation see instruction for use given with the package of the product.

Curing time for general conditions



Data according ETA-08/0105, issue 2014-04-30			
Temperature of the base material	Working time in which rebar can be inserted and adjusted t_{gel}	Initial curing time $t_{cure,ini}$	Curing time before rebar can be fully loaded t_{cure}
$5\text{ °C} \leq T_{BM} < 10\text{ °C}$	2 h	18 h	72 h
$10\text{ °C} \leq T_{BM} < 15\text{ °C}$	90 min	12 h	48 h
$15\text{ °C} \leq T_{BM} < 20\text{ °C}$	30 min	9 h	24 h
$20\text{ °C} \leq T_{BM} < 25\text{ °C}$	20 min	6 h	12 h
$25\text{ °C} \leq T_{BM} < 30\text{ °C}$	20 min	5 h	12 h
$30\text{ °C} \leq T_{BM} < 40\text{ °C}$	12 min	4 h	8 h
$T_{BM} = 40\text{ °C}$	12 min	4 h	4 h

For dry concrete curing times may be reduced according to the following table. For installation temperatures below +5 °C all load values have to be reduced according to the load reduction factors given below.

Curing time for dry concrete

Additional Hilti technical data				
Temperature of the base material	Working time in which rebar can be inserted and adjusted t_{gel}	Initial curing time $t_{cure,ini}$	Reduced curing time before rebar can be fully loaded t_{cure}	Load reduction factor
$T_{BM} = -5\text{ °C}$	4 h	36 h	72 h	0,6
$T_{BM} = 0\text{ °C}$	3 h	25 h	50 h	0,7
$T_{BM} = 5\text{ °C}$	2 ½ h	18 h	36 h	1
$T_{BM} = 10\text{ °C}$	2 h	12 h	24 h	1
$T_{BM} = 15\text{ °C}$	1 ½ h	9 h	18 h	1
$T_{BM} = 20\text{ °C}$	30 min	6 h	12 h	1
$T_{BM} = 30\text{ °C}$	20 min	4 h	8 h	1
$T_{BM} = 40\text{ °C}$	12 min	2 h	4 h	1

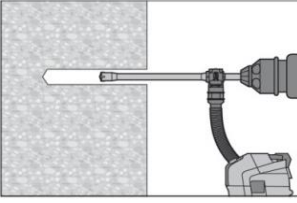
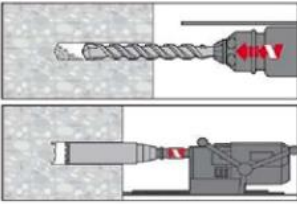
Setting instruction

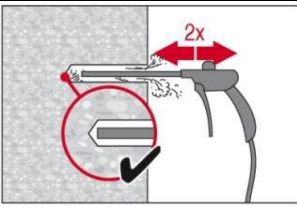
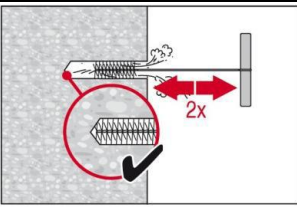
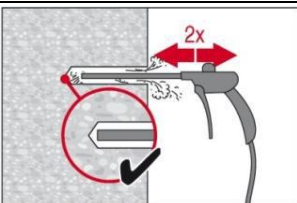
<p>Safety Regulations:</p> 	<p>Review the Material Safety Data Sheet (MSDS) before use for proper and safe handling! Wear well-fitting protective goggles and protective gloves when working with Hilti HIT-RE 500. Important: Observe the installation instruction of the manufacturer provided with each foil pack.</p>
<p>1. Drill hole</p>	<p>Note: Before drilling, remove carbonized concrete; clean contact areas (see Annex B1) In case of aborted drill hole the drill hole shall be filled with mortar.</p>
	<p>Drill hole to the required embedment depth with an appropriately sized Hilti TE-CD or TE-YD hollow drill bit with Hilti vacuum attachment. This drilling system removes the dust and cleans the bore hole during drilling when used in accordance with the user's manual. After drilling is complete, proceed to the "injection preparation" step in the instructions for use.</p>
	<p>Drill the hole to the required embedment depth using a hammer-drill with carbid drill bit set in rotation hammer mode, a compressed air drill or a diamond core machine.</p> <p>Hammer drill (HD) Compressed air drill (CA) Diamond core wet (DD) and dry (PCC)</p> 
<p>4. Bore hole cleaning</p>	<p>(Not needed with Hilti TE-CD and Hilti TE-YD drill bit) The borehole must be free of dust, debris, water, ice, oil, grease and other contaminants prior to mortar injection.</p> <p>Just before setting an anchor, the bore hole must be free of dust and debris by one of two cleaning methods described below</p>
<p>Compressed air cleaning (CAC)</p>	
	<p>Blowing 2 times from the back of the hole with oil-free compressed air (min. 6 bar at 100 litres per minute (LPM)) until return air stream is free of noticeable dust. Bore hole diameter ≥ 32 mm the compressor must supply a minimum air flow of 140 m³/hour. If required use additional accessories and extensions for air nozzle and brush to reach back of hole.</p>
	<p>Brushing 2 times with the specified brush HIT-RB size (brush $\varnothing \geq$ borehole \varnothing) by inserting the round steel brush to the back of the hole in a twisting motion. The brush shall produce natural resistance as it enters the anchor hole. If this is not the case, please use a new brush or a brush with a larger diameter.</p>
	<p>Blowing 2 times again with compressed air until return air stream is free of noticeable dust. If required use additional accessories and extensions for air nozzle and brush to reach back of hole.</p>



Deep boreholes – Blowing

For boreholes deeper than 250mm (for $\varnothing=8\text{mm} - 12\text{mm}$) or deeper than $20 \varnothing$ (for $\varnothing>12\text{mm}$) use the appropriate air nozzle Hilti HIT-DL

Safety tip: Do not inhale concrete dust.

The application of the dust collector Hilti HIT-DRS is recommended.

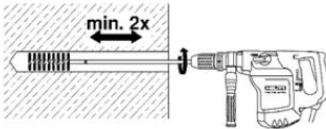

Deep boreholes – Brushing

For boreholes deeper than 250 mm (for $\varnothing=8\text{mm} - 12\text{mm}$) or deeper than $20 \varnothing$ (for $\varnothing>12\text{mm}$) use machine brushing and brush extensions HIT-RBS.

Screw the round steel brush HIT-RB in one end of the brush extension(s) HIT-RBS, so that the overall length of the brush is sufficient to reach the base of the borehole. Attach the other end of the extension to the TE-C/TE-Y chuck.

Safety tip:

- Start machine brushing operational slowly.
- Start brushing operation once brush is inserted in borehole.

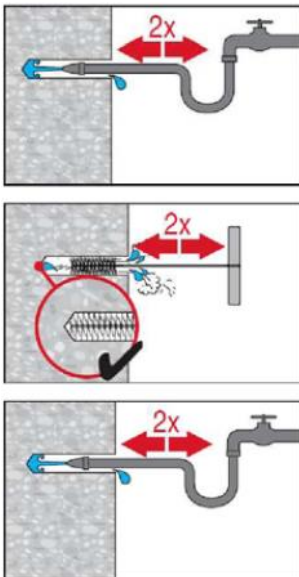

In addition for wet diamond coring (DD):

For wet diamond coring please observe the following steps in addition **prior to** compressed air cleaning:

Remove all core fragments from the anchor hole. Flush the anchor hole with clear running water until water runs clear. Brush the anchor hole again 2 times with the appropriate sized brush over the entire depth of the anchor hole. Repeat the flushing process until water runs out of the anchor hole.

Manual Cleaning (MC) Manual cleaning is permitted for hammer drilled boreholes up to hole diameters $d_0 \leq 20\text{mm}$ and depths l_v resp. $l_{e,ges.} \leq 160\text{mm}$.

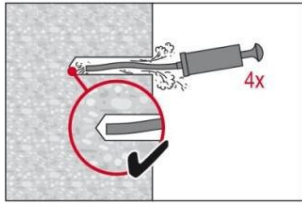

Blowing
4 strokes with Hilti blow-out pump from the back of the hole until return air stream is free of noticeable dust.

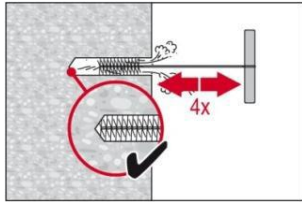

Brushing
4 times with the specified brush HIT_RB size (brush $\varnothing \geq$ borehole \varnothing) by inserting the round steel wire brush to the back of the hole with a twisting motion. The brush shall produce natural resistance as it enters the anchor hole. If this is not the case, please use a new brush or a brush with a larger diameter.

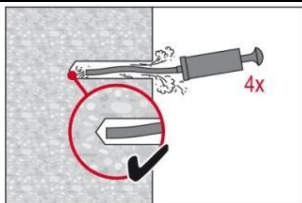

Blowing
4 strokes with Hilti blow-out pump from the back of the hole until return air stream is free of noticeable dust.



Manual Cleaning (MC)

Hilti hand pump recommended for blowing out bore hole with diameters $d < 20\text{mm}$ and bore hole depth $h_0 < 160\text{mm}$

3.Rebar preparation and foil pack preparation

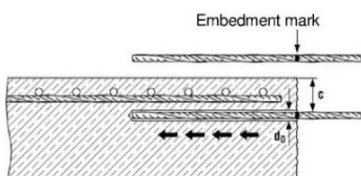

Before use, make sure the rebar is dry and free of oil or other residue.

Mark the embedment depth on the rebar. (e.g. with tape), l_v

Insert rebar in borehole, to verify hole and setting depth l_v resp. $l_{e,ges}$

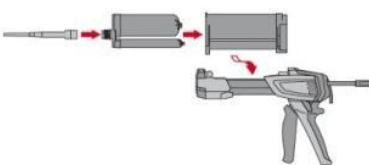

- Observe the Instruction for Use of the dispenser and the mortar.
- Tightly attach Hilti HIT-RE-M mixing nozzle to foil pack manifold.
- Insert foil pack into foil pack holder and swing holder into the dispenser.

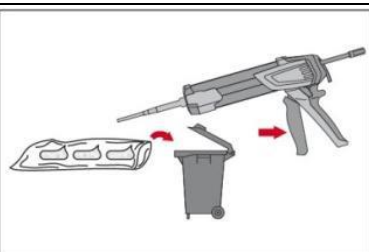

Discard initial mortar. The foil pack opens automatically as dispensing is initiated. Depending on the size of the foil pack an initial amount of adhesive has to be discarded.
After changing a mixing nozzle, the first few trigger pulls must be discarded as described above. For each new foil pack a new mixing nozzle must be used.

Discard quantities are

- 3 strokes for 330 ml foil pack,
- 4 strokes for 500 ml foil pack,
- 65 ml for 1400 ml foil pack,

4.Inject mortar into borehole Forming air pockets be avoided

4.1 Injection method for borehole depth ≤ 250 mm

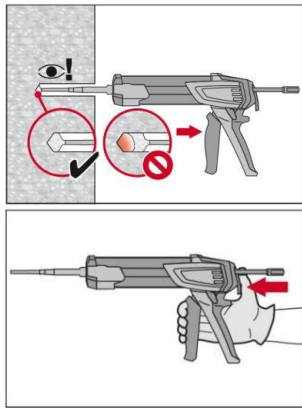

Inject the mortar from the back of the hole towards the front and slowly withdraw the mixing nozzle step by step after each trigger pull.

Fill holes approximately 2/3 full, or as required to ensure that the annular gap between the rebar and the concrete is completely filled with adhesive over the embedment length.

After injecting, depressurize the dispenser by pressing the release trigger. This will prevent further mortar discharge from the mixing nozzle.

4.2 Injection method for borehole depth > 250 mm or overhead application

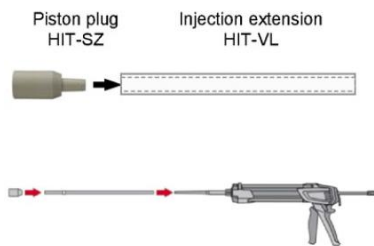

Assemble mixing nozzle HIT-RE-M, extension(s) and piston plug HIT-SZ.

For combinations of several injection extensions use coupler HIT-VL K. A substitution of the injection extension for a plastic hose or a combination of both is permitted.

The combination of HIT-SZ piston plug with HIT-VL 16 pipe and then HIT-VL 16 tube support proper injection.

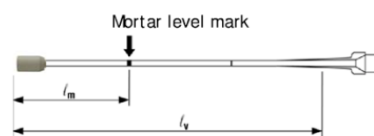

Mark the required mortar level l_m and embedment depth l_b resp.

$l_{e,ges}$ with tape or marker on the injection extension.

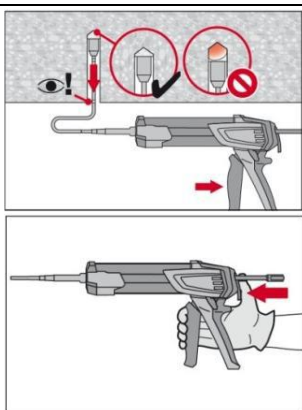

Insert piston plug to back of the hole. Begin injection allowing the pressure of the injected adhesive mortar to push the piston plug towards the front of the hole.

Fill holes approximately 2/3 full, or as required to ensure that the annular gap between the rebar and the concrete is completely filled with adhesive over the embedment length.

Injection until the mortar level mark l_m becomes visible.

After injecting, depressurize the dispenser by pressing the release trigger. This will prevent further mortar discharge from the mixing nozzle.

5. Insert rebar

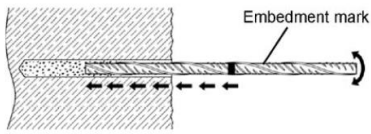

For easy installation insert the rebar slowly twisted into the borehole until the embedment mark is at the concrete surface level.

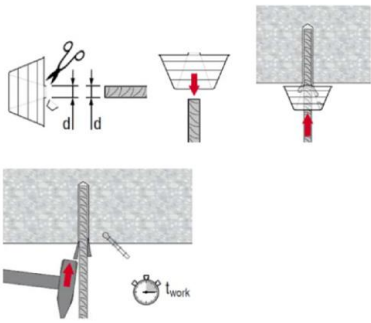

Overhead application:

During insertion of the rebar, mortar might flow out of the borehole. For collection of the flowing mortar, HIT-OHC may be used.

Support the rebar and secure it from falling till mortar started to harden, e.g. using wedges HIT-OHW.

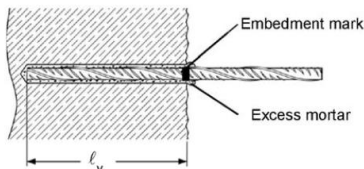

After installing the rebar the annular gap must be completely filled with mortar.

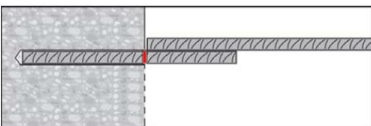

After installing the rebar the annular gap must be completely filled with mortar.

Proper installation can be verified when:

Desired anchoring embedment is reached l_v : embedment mark at concrete surface.

Excess mortar flows out of the borehole after the rebar has been fully inserted until the embedment mark.

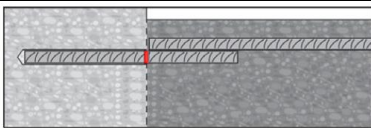

Full load may be applied only after the curing time " t_{cure} " has elapsed.

Fitness for use

Some creep tests have been conducted in accordance with ETAG guideline 001 part 5 and TR 023 in the following conditions : in dry environment at 50 °C during 90 days.

These tests show an excellent behaviour of the post-installed connection made with HIT-RE 500: low displacements with long term stability, failure load after exposure above reference load.

Resistance to chemical substances

Categories	Chemical substances	resistant	Non resistant
Alkaline products	Drilling dust slurry pH = 12,6	+	
	Potassium hydroxide solution (10%) pH = 14	+	
Acids	Acetic acid (10%)		+
	Nitric acid (10%)		+
	Hydrochloric acid (10%)		+
	Sulfuric acid (10%)		+
Solvents	Benzyl alcohol		+
	Ethanol		+
	Ethyl acetate		+
	Methyl ethyl keton (MEK)		+
	Trichlor ethylene		+
	Xylol (mixture)	+	
Products from job site	Concrete plasticizer	+	
	Diesel	+	
	Engine oil	+	
	Petrol	+	
	Oil for form work	+	
Environnement	Sslt water	+	
	De-mineralised water	+	
	Sulphurous atmosphere (80 cycles)	+	

Electrical Conductivity

HIT-RE 500 in the hardened state **does not conduct electrically**. Its electric resistivity is $66 \cdot 10^{12} \Omega \cdot m$ (DIN IEC 93 – 12.93). It is adapted well to realize electrically insulating anchorings (ex: railway applications, subway).

Drilling diameters

Rebar (mm)	Drill bit diameters d_0 [mm]			
	Hammer drill (HD) Hollow Drill Bit (HDB)	Compressed air drill (CA)	Diamond coring	
			Wet (DD)	Dry (PCC)
8	12 (10 ^{a)})	-	12 (10 ^{a)})	-
10	14 (12 ^{a)})	-	14 (12 ^{a)})	-
12	16 (14 ^{a)})	17	16 (14 ^{a)})	-
14	18	17	18	-
16	20	20	20	-
18	22	22	22	-
20	25	26	25	-
22	28	28	28	-
24	32	32	32	35
25	32	32	32	35
26	35	35	35	35
28	35	35	35	35
30	37	35	37	35
32	40	40	40	47
34	45	42	42	47
36	45	45	47	47
40	55	57	52	52

a) Max. installation length $l = 250$ mm.

Basic design data for rebar design according to rebar ETA

Bond strength in N/mm² according to ETA 08/0105 for good bond conditions for hammer drilling, compressed air drilling, dry diamond core drilling

Rebar (mm)	Concrete class								
	C12/15	C16/20	C20/25	C25/30	C30/37	C35/45	C40/50	C45/55	C50/60
8 - 32	1,6	2,0	2,3	2,7	3,0	3,4	3,7	4,0	4,3
34	1,6	2,0	2,3	2,6	2,9	3,3	3,6	3,9	4,2
36	1,5	1,9	2,2	2,6	2,9	3,3	3,6	3,8	4,1
40	1,5	1,8	2,1	2,5	2,8	3,1	3,4	3,7	4,0

Bond strength in N/mm² according to ETA 08/0105 for good bond conditions for wet diamond core drilling

Rebar (mm)	Concrete class								
	C12/15	C16/20	C20/25	C25/30	C30/37	C35/45	C40/50	C45/55	C50/60
8 - 25	1,6	2,0	2,3	2,7	3,0	3,4	3,7	4,0	4,3
26 - 32	1,6	2,0	2,3	2,7	2,7	2,7	2,7	2,7	2,7
34	1,6	2,0	2,3	2,6	2,6	2,6	2,6	2,6	2,6
36	1,5	1,9	2,2	2,6	2,6	2,6	2,6	2,6	2,6
40	1,5	1,8	2,1	2,5	2,5	2,5	2,5	2,5	2,5

Pullout design bond strength for Hit Rebar design

Design bond strength in N/mm² according to ETA 04/0027 (values in table are design values, $f_{bd,po} = \tau_{Rk}/\gamma_{Mp}$)

Hammer or compressed air drilling.
Water saturated, water filled or submerged hole.
Uncracked concrete C20/25.

temperature range	Bar diameter													
	Data according to ETA 04/0027												Hilti tech data	
	8	10	12	14	16	20	22	24	25	26	28	30	32	36
I: 40°C/24°C	7,1			6,7			6,2						5,2	4,8
II: 58°C/35°C	5,7				5,2				4,8				4,3	3,8
III: 70°C/43°C	3,3				3,1				2,9				2,4	

Increasing factor in non-cracked concrete: $f_{B,p} = (f_{cck}/25)^{0,1}$ (f_{cck} : characteristic compressive strength on cube)

Additional Hilti Technical Data:

If the concrete is dry (not in contact with water before/during installation and curing), the pullout design bond strength may be increased by 20%.

If the hole was produced by wet diamond coring, the pullout design bond strength has to be reduced by 30%.

Reduction factor for splitting with large concrete cover: $\delta = 0,306$ (Hilti additional data)

Fire Resistance according to DIBt Z-21.8-1790

a) fire situation “anchorage”

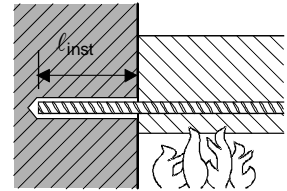

Maximum force in rebar in conjunction with HIT-RE 500 as a function of embedment depth for the fire resistance classes F30 to F180 (yield strength $f_{yk} = 500 \text{ N/mm}^2$) according EC2^{a)}.

Bar \varnothing	Drill hole \varnothing	Max. $F_{s,T}$	l_{inst}	Fire resistance of bar in [kN]				
				R30	R60	R90	R120	R180
[mm]	[mm]	[kN]	[mm]					
8	10	16,19	80	2,4	1,0	0,5	0,3	0
			95	3,9	1,7	0,3	0,6	0,1
			115	7,3	3,1	1,7	1,1	0,4
			150	16,2	8,2	4,6	3,1	1,4
			180		16,2	10,0	6,7	2,9
			205			16,2	12,4	5,1
			220				16,2	7,0
			265				16,2	
10	12	25,29	100	5,7	2,5	1,3	0,8	0,2
			120	10,7	4,4	2,5	1,7	0,7
			140	17,6	7,8	4,4	3,0	1,3
			165	25,3	15,1	8,5	5,8	2,6
			195		25,3	17,6	12,2	5,1
			220			25,3	20,7	8,7
			235				25,3	11,8
			280				25,3	
12	16	36,42	120	12,8	5,3	3,0	2,0	0,8
			150	25,2	12,2	6,9	4,7	2,1
			180	36,4	24,3	15,0	10,1	4,4
			210		36,2	27,4	20,6	8,5
			235			36,4	31,0	14,2
			250				36,4	19,1
			295				36,4	
14	18	49,58	140	24,6	10,9	6,1	4,2	1,9
			170	39,1	23,5	13,5	9,2	4,1
			195	49,6	35,6	24,7	17,1	7,2
			225		49,6	39,2	31,3	13,5
			250			49,6	43,4	22,3
			265				49,6	29,5
			310				49,6	
16	20	64,75	160	39,2	21,3	11,9	8,1	3,6
			190	55,8	37,9	25,5	17,3	7,3
			210	64,8	49,0	36,5	27,5	11,3
			240		64,8	53,1	44,1	20,9
			265			64,8	57,9	33,7
			280				64,8	42,0
			325				64,8	

Bar \varnothing	Drill hole \varnothing	Max. $F_{s,T}$	l_{inst}					
			[mm]	R30	R60	R90	R120	R180
20	25	101,18	200	76,6	54,3	38,7	27,5	11,4
			240	101,2	82,0	66,4	55,1	26,1
			270		101,2	87,1	75,9	45,6
			295			101,2	93,2	62,9
			310				101,2	73,2
			355					101,2
25	30	158,09	250	139,0	111,1	91,6	77,6	39,9
			275	158,1	132,7	113,2	99,2	61,3
			305		158,1	139,1	125,1	87,2
			330			158,1	146,7	108,8
			345				158,1	121,8
			390					158,1
28	35	198,3	280	184,7	153,4	131,6	115,9	73,5
			295	198,3	168,0	146,1	130,4	88,0
			330		198,3	180,0	164,3	121,9
			350			198,3	183,6	141,2
			370				198,3	160,6
			410					198,3
32	40	259,02	320	255,3	219,6	194,7	176,7	128,2
			325	259,0	225,1	200,2	182,2	133,8
			360		259,0	238,9	220,9	172,5
			380			259,0	243,1	194,6
			395				259,0	211,2
			440					259,0
40	47	404,71	400	404,7	385,1	353,9	331,5	270,9
			415		404,7	374,6	352,2	291,6
			440			404,7	386,8	326,2
			455				404,7	346,9
			500					404,7

^{a)} For tables according the standards to DIN 1045-1988, NF-ENV 1991-2-2(EC2), Österreichische Norm B 4700-2000, British-, Singapore- and Australian Standards see Warringtonfire report WF 166402 or/and IBMB Braunschweig report No 3357/0550-5.

b) fire situation parallel

Max. bond stress, τ_T , depending on actual clear concrete cover for classifying the fire resistance.

It must be verified that the actual force in the bar during a fire, $F_{s,T}$, can be taken up by the bar connection of the selected length, l_{inst} . Note: Cold design for ULS is mandatory.

$$F_{s,T} \leq (l_{inst} - c_f) \cdot \phi \cdot \pi \cdot \tau_T \quad \text{where: } (l_{inst} - c_f) \geq l_s;$$

l_s = lap length

ϕ = nominal diameter of bar

$l_{inst} - c_f$ = selected overlap joint length; this must be at least l_s ,
but may not be assumed to be more than 80ϕ

τ_T = bond stress when exposed to fire

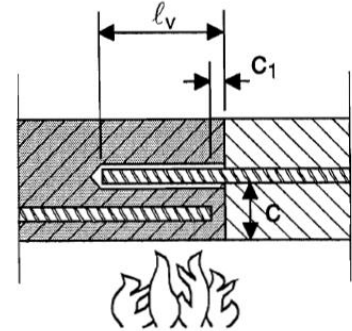

Critical temperature-dependent bond stress, τ_c , concerning “overlap joint” for Hilti HIT-RE 500 injection adhesive in relation to fire resistance class and required minimum concrete coverage c.

Clear concrete cover c [mm]	Max. bond stress, τ_c [N/mm ²]								
	R30	R60	R90	R120	R180				
30	0,7	0	0	0	0				
35	0,8	0,4							
40	0,9	0,5							
45	1,0	0,5							
50	1,2	0,6							
55	1,4	0,7	0,5						
60	1,6	0,8	0,5						
65	1,9	0,9	0,6	0,4					
70	2,2	1,0	0,7	0,5					
75		1,2	0,7	0,5					
80		1,4	0,8	0,6					
85		1,5	0,9	0,7					
90		1,7	1,1	0,8	0,5				
95		2,0	1,2	0,9	0,5				
100		2,2	2,2	1,4	1,0	0,6			
105				1,6	1,1	0,6			
110				1,7	1,2	0,7			
115				2,0	1,4	0,7			
120	2,2			2,2	2,2	1,6	0,8		
125						1,7	0,9		
130						2,0	1,0		
135						2,2	2,2	2,2	1,1
140									1,2
145									1,3
150		1,4							
155		1,6							
160		1,7							
165		1,9							
170	2,1								
175	2,2								

Minimum anchorage length



According to ETA-08/0105, issue 2014-04-30, the minimum anchorage length shall be increased by factor 1,5 for wet diamond core drilling. For all the other given drilling methods the factor is 1,0.

Minimum anchorage and lap lengths for C20/25; maximum hole lengths (ETA 08/0105)

Rebar		Hammer drilling, Compressed air drilling, Dry diamond coring drilling		Wet diamond coring drilling		l_{max} [mm]
Diameter d_s [mm]	$f_{y,k}$ [N/mm ²]	$l_{b,min}^*$ [mm]	$l_{o,min}^*$ [mm]	$l_{b,min}^*$ [mm]	$l_{o,min}^*$ [mm]	
8	500	113	200	170	300	1000
10	500	142	200	213	300	1000
12	500	170	200	255	300	1200
14	500	198	210	298	315	1400
16	500	227	240	340	360	1600
18	500	255	270	383	405	1800
20	500	284	300	425	450	2000
22	500	312	330	468	495	2200
24	500	340	360	510	540	2400
25	500	354	375	532	563	2500
26	500	369	390	553	585	2600
28	500	397	420	595	630	2800
30	500	425	450	638	675	3000
32	500	454	480	681	720	3200
34	500	492	510	738	765	3200
36	500	532	540	797	810	3200
40	500	616	621	925	932	3200

* $l_{b,min}$ (8.6) and $l_{o,min}$ (8.11) are calculated for good bond conditions with maximum utilisation of rebar yield strength $f_{yk} = 500 \text{ N/mm}^2$ and $\alpha_6 = 1,0$

Hilti HIT-HY 200 mortar with rebar (as post-installed connection)

Injection mortar system	Benefits
 <p>Hilti HIT-HY 200-R 330 ml foil pack (also available as 500 ml foil pack)</p> <p>Hilti HIT-HY 200-A 330 ml foil pack (also available as 500 ml foil pack)</p>  <p>Static mixer</p>  <p>Rebar</p>	<ul style="list-style-type: none"> - SAFEset technology: drilling and borehole cleaning in one step with Hilti hollow drill bit - HY 200-R version is formulated for best handling and cure time specifically for rebar applications - Suitable for concrete C 12/15 to C 50/60 - Suitable for dry and water saturated concrete - For rebar diameters up to 32 mm - Non corrosive to rebar elements - Good load capacity at elevated temperatures - Suitable for embedment length up to 1000 mm - Suitable for applications down to -10 °C - Two mortar (A and R) versions available with different curing times and same performance

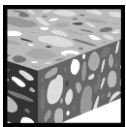

Concrete



Fire resistance



European Technical Approval



Corrosion tested



PROFIS Rebar design software



Hilti **SAFEset** technology with hollow drill bit

Service temperature range

Temperature range: -40°C to +80°C (max. long term temperature +50°C, max. short term temperature +80°C).

Approvals / certificates

Description	Authority / Laboratory	No. / date of issue
European technical approval ^{a)}	DIBt, Berlin	ETA-12/0083 / 2013-06-05 (HIT-HY 200-R) ETA-11/0492 / 2013-06-05 (HIT-HY 200-A)
Fire test report	CSTB, Paris	26033756

a) All data given in this section according ETA-12/0083, issued 2013-06-05 and ETA-11/0492, issued 2013-06-05.

Materials

Reinforcement bars according to EC2 Annex C Table C.1 and C.2N.

Properties of reinforcement

Product form		Bars and de-coiled rods	
Class		B	C
Characteristic yield strength f_{yk} or $f_{0,2k}$ (MPa)		400 to 600	
Minimum value of $k = (f_t/f_y)_k$		$\geq 1,08$	$\geq 1,15$ < 1,35
Characteristic strain at maximum force, ϵ_{uk} (%)		$\geq 5,0$	$\geq 7,5$
Bendability		Bend / Rebend test	
Maximum deviation from nominal mass (individual bar) (%)	Nominal bar size (mm)		
	≤ 8	$\pm 6,0$	
	> 8	$\pm 4,5$	
Bond: Minimum relative rib area, $f_{R,min}$	Nominal bar size (mm)		
	8 to 12	0,040	
	> 12	0,056	

Setting details

For detailed information on installation see instruction for use given with the package of the product.

Working time, curing time^{a)}

Temperature of the base material	HIT-HY 200-R	
	Working time in which anchor can be inserted and adjusted t_{work}	Curing time before anchor can be fully loaded t_{cure}
-10 °C to -5 °C	3 hour	20 hour
-4 °C to 0 °C	2 hour	7 hour
1 °C to 5 °C	1 hour	3 hour
6 °C to 10 °C	40 min	2 hour
11 °C to 20 °C	15 min	1 hour
21 °C to 30 °C	9 min	1 hour
31 °C to 40 °C	6 min	1 hour

Temperature of the base material	HIT-HY 200-A	
	Working time in which anchor can be inserted and adjusted t_{work}	Curing time before anchor can be fully loaded t_{cure}
-10 °C to -5 °C	1,5 hour	7 hour
-4 °C to 0 °C	50 min	4 hour
1 °C to 5 °C	25 min	2 hour
6 °C to 10 °C	15 min	1 hour
11 °C to 20 °C	7 min	30 min
21 °C to 30 °C	4 min	30 min
31 °C to 40 °C	3 min	30 min

Setting instruction

a) Dry and water-saturated concrete, hammer drilling

Bore hole drilling

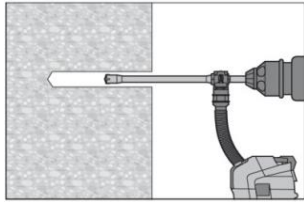

Drill hole to the required embedment depth with an appropriately sized Hilti TE-CD or TE-YD hollow drill bit with Hilti vacuum attachment. This drilling method properly cleans the borehole and removes dust while drilling. After drilling is complete, proceed to the "injection preparation" step in the instructions for use.

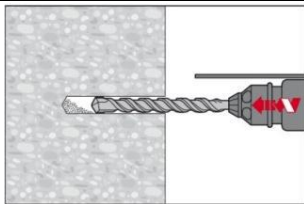

Drill hole to the required embedment depth using a hammer-drill with carbide drill bit set in rotation hammer mode, a Hilti hollow drill bit or a compressed air drill.

Bore hole cleaning Just before setting an anchor, the bore hole must be free of dust and debris by one of two cleaning methods described below

b) Compressed air cleaning (CAC)

For all bore hole diameters d_0 and all bore hole depth h_0

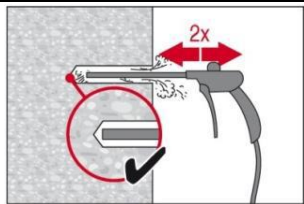

Blowing 2 times from the back of the hole with oil-free compressed air (min. 6 bar at 100 litres per minute (LPM)) until return air stream is free of noticeable dust. Bore hole diameter ≥ 32 mm the compressor must supply a minimum air flow of 140 m³/hour. If required use additional accessories and extensions for air nozzle and brush to reach back of hole.

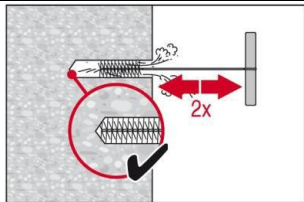

Brushing 2 times with the specified brush size (brush $\varnothing \geq$ borehole \varnothing) by inserting the round steel brush to the back of the hole in a twisting motion. The brush shall produce natural resistance as it enters the anchor hole. If this is not the case, please use a new brush or a brush with a larger diameter.

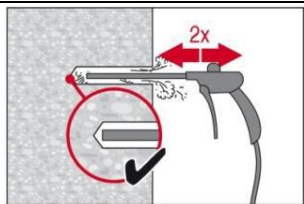

Blowing 2 times again with compressed air until return air stream is free of noticeable dust.

a) Manual Cleaning (MC)

As an alternative to compressed air cleaning, a manual cleaning is permitted for hammer drilled boreholes up to hole diameters $d_0 \leq 20\text{mm}$ and depths l_v resp. $l_{e,ges.} \leq 160\text{mm}$ or $10 * d$. The borehole must be free of dust, debris, water, ice, oil, grease and other contaminants prior to mortar injection.

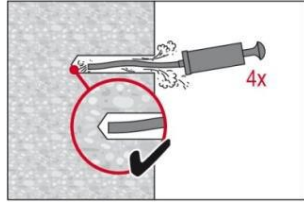

4 strokes with Hilti blow-out pump from the back of the hole until return air stream is free of noticeable dust.

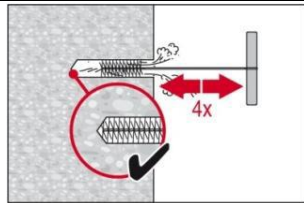

4 times with the specified brush size (brush $\varnothing \geq$ borehole \varnothing) by inserting the round steel wire brush to the back of the hole with a twisting motion

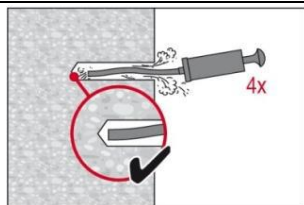

4 strokes with Hilti blow-out pump from the back of the hole until return air stream is free of noticeable dust.

Injection preparation

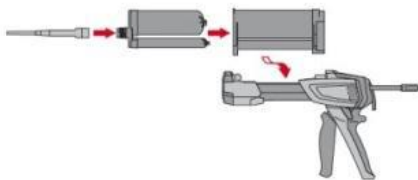

Observe the Instruction for Use of the dispenser.
Observe the Instruction for Use of the mortar.
Tightly attach Hilti HIT-RE-M mixing nozzle to foil pack manifold.
Insert foil pack into foil pack holder and swing holder into the dispenser.

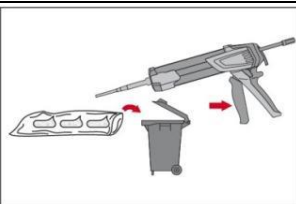

Discard initial adhesive. The foil pack opens automatically as dispensing is initiated. Depending on the size of the foil pack an initial amount of adhesive has to be discarded.

Discard quantities are

- 2 strokes for 330 ml foil pack,
- 3 strokes for 500 ml foil pack,
- 4 strokes for 500 ml foil pack $\leq 5^\circ\text{C}$.

Inject adhesive from the back of the borehole without forming air voids

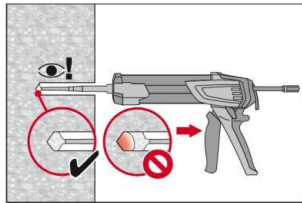

Injection method for borehole depth ≤ 250 mm:

Inject the mortar from the back of the hole towards the front and slowly withdraw the mixing nozzle step by step after each trigger pull. **Important! Use extensions for deep holes (> 250 mm).** Fill holes approximately 2/3 full, or as required to ensure that the annular gap between the rebar and the concrete is completely filled with adhesive over the embedment length.

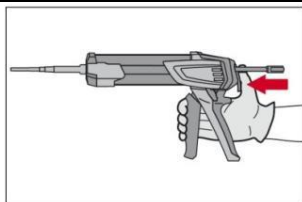

After injecting, depressurize the dispenser by pressing the release trigger (only for manual dispenser). This will prevent further mortar discharge from the mixing nozzle.

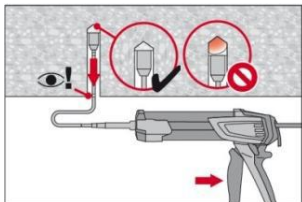

Piston plug injection for borehole depth > 250 mm or overhead applications:

Assemble mixing nozzle, extension(s) and appropriately sized piston plug. Insert piston plug to back of the hole. Begin injection allowing the pressure of the injected adhesive mortar to push the piston plug towards the front of the hole. After injecting, depressurize the dispenser by pressing the release trigger. This will prevent further mortar discharge from the mixing nozzle.

The proper injection of mortar using a piston plug HIT-SZ prevents the creation of air voids. The piston plug must be insertable to the back of the borehole without resistance. During injection the piston plug will be pressed towards the front of the borehole slowly by mortar pressure. Attention! Pulling the injection or when changing the foil pack, the piston plug is rendered inactive and air voids may occur.

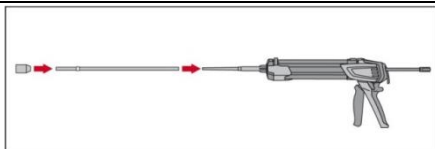

- HDM 330** Manual dispenser (330 ml)
- HDM 500** Manual dispenser (330 / 500 ml)
- HDE 500-A22** Electric dispenser (330 / 500 ml)

Setting the element

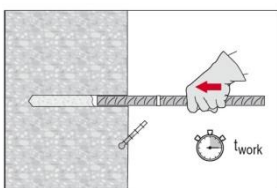

Before use, verify that the element is dry and free of oil and other contaminants.

Mark and set element to the required embedment depth until working time t_{work} has elapsed.

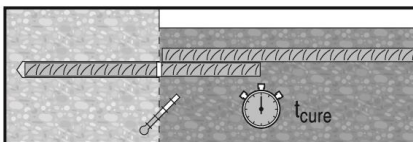

After installing the rebar the annular gap must be completely filled with mortar.

Proper installation can be verified when:

Desired anchoring embedment is reached l_v :

Embedment mark at concrete surface.

Excess mortar flows out of the borehole after the rebar has been fully inserted until the embedment mark.

Overhead application: Support the rebar and secure it from falling till mortar started to harden.

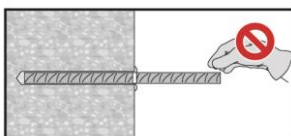

Observe the working time " t_{work} ", which varies according to temperature of base material. Minor adjustments to the rebar position may be performed during the working time. After t_{cure} preparation work may continue.

For detailed information on installation see instruction for use given with the package of the product.

Resistance to chemical substances

Chemical	Resistance	Chemical	Resistance
Air	+	Gasoline	+
Acetic acid 10%	+	Glycole	o
Acetone	o	Hydrogen peroxide 10%	o
Ammonia 5%	+	Lactic acid 10%	+
Benzyl alcohol	-	Machinery oil	+
Chloric acid 10%	o	Methylethylketon	o
Chlorinated lime 10%	+	Nitric acid 10%	o
Citric acid 10%	+	Phosphoric acid 10%	+
Concrete plasticizer	+	Potassium Hydroxide pH 13,2	+
De-icing salt (Calcium chloride)	+	Sea water	+
Demineralized water	+	Sewage sludge	+
Diesel fuel	+	Sodium carbonate 10%	+
Drilling dust suspension pH 13,2	+	Sodium hypochlorite 2%	+
Ethanol 96%	-	Sulfuric acid 10%	+
Ethylacetate	-	Sulfuric acid 30%	+
Formic acid 10%	+	Toluene	o
Formwork oil	+	Xylene	o

- + resistant
- o resistant in short term (max. 48h) contact
- not resistant

Electrical Conductivity

HIT-HY 200 in the hardened state **is not conductive electrically**. Its electric resistivity is $15,5 \cdot 10^9 \Omega \cdot \text{cm}$ (DIN IEC 93 – 12.93). It is adapted well to realize electrically insulating anchorings (ex: railway applications, subway).

Drilling diameters

Rebar (mm)	Drill bit diameters d_0 [mm]	
	Hammer drill (HD)	Compressed air drill (CA)
8	12 (10 ^{a)})	-
10	14 (12 ^{a)})	-
12	16 (14 ^{a)})	17
14	18	17
16	20	20
18	22	22
20	25	26
22	28	28
24	32	32
25	32	32
26	35	35
28	35	35
30	37	35
32	40	40

a) Max. installation length $l = 250$ mm.

Basic design data for rebar design according to ETA

Bond strength

Bond strength in N/mm^2 according to ETA for good bond conditions

Rebar (mm)	Concrete class								
	C12/15	C16/20	C20/25	C25/30	C30/37	C35/45	C40/50	C45/55	C50/60
8 - 32	1,6	2,0	2,3	2,7	3,0	3,4	3,7	4,0	4,3

Minimum anchorage length

Minimum and maximum embedment depths and lap lengths for C20/25 according to ETA

Rebar		$l_{b,min}^*$ [mm]	$l_{o,min}^*$ [mm]	Concrete temp. $\geq -10^\circ\text{C}$	Concrete temp. $\geq 0^\circ\text{C}$
Diameter d_s [mm]	$f_{y,k}$ [N/mm ²]			l_{max} [mm]	l_{max} [mm]
8	500	113	200	700	1000
10	500	142	200	700	1000
12	500	170	200	700	1000
14	500	198	210	700	1000
16	500	227	240	700	1000
18	500	255	270	700	1000
20	500	284	300	700	1000
22	500	312	330	700	1000
24	500	340	360	700	1000
25	500	354	375	700	1000
26	500	369	390	700	1000
28	500	397	420	700	1000
30	500	425	450	700	1000
32	500	454	480	700	1000

* $l_{b,min}$ (8.6) and $l_{o,min}$ (8.11) are calculated for good bond conditions with maximum utilisation of rebar yield strength $f_{yk} = 500 \text{ N/mm}^2$ and $\alpha_6 = 1,0$

Hilti HIT-HY 110 mortar with rebar (as post-installed connection)

Injection mortar system		Benefits
	Hilti HIT-HY 110 500 ml foil pack (also available as 330 ml foil pack)	<ul style="list-style-type: none"> - suitable for concrete C 12/15 to C 50/60 - suitable for dry and water saturated concrete - for rebar diameters up to 25 mm - non corrosive to rebar elements - good loading capacity and fast cure - suitable for applications down to -5 °C - Suitable for embedment depth up to 1500 mm depending on the rebar diameter
	Static mixer	
	rebar	



Concrete



European
Technical
Approval



CE
conformity

Approvals / certificates

Description	Authority / Laboratory	No. / date of issue
European Technical Assessment ^{a)}	DIBt, Berlin	ETA-13/1037 / 2014-05-26

a) All data given in this section according ETA-13/1037 issue 2014-05-26.

Materials

Designation	Reinforcement bars
Rebar EN 1992-1-1:2004/AC:2010, Annex C	Bars and de-coiled rods Class B or C with f_{yk} section EN 1992-1-1/NA:2013 $f_{uk} = f_{tk} = k \cdot f_{yk}$

Setting details

Working time, Curing time

Temperature of the base material T_{BM}	Working time $t_{work}^{a)}$	Curing time t_{cure}
-5 °C to -1 °C	90 min	9 h
0 °C to 4 °C	45 min	4,5 h
5 °C to 9 °C	20 min	2 h
10 °C to 19 °C	6 min	90 min
20 °C to 29 °C	4 min	50 min
30 °C to 40 °C ^{b)}	2 min	40 min

a) The temperature of the foil pack must be between +5 °C and +25 °C during injection.

b) Foil pack temperature must be between +15 °C to +20 °C

Installation equipment

Rebar (mm)	8	10	12	14	16	18	20	22	24	25
Rotary hammer	TE 2 – TE 40					TE 40 – TE 70				
Other tools	compressed air gun or blow out pump, set of cleaning brushes, dispenser									

Drilling diameters

Rebar (mm)	Drill bit diameters d_0 [mm]	
	Hammer drill (HD)	Compressed air drill (CA)
8	12 (10) ^{a)}	-
10	14 (12) ^{a)}	-
12	16 (14) ^{a)}	17
14	18	17
16	20	20
18	22	22
20	25	26
22	28	28
24	32	32
25	32	32

a) Values in brackets valid for maximum drilling depth of 250 mm

Dispensers and corresponding maximum embedment depth $l_{v,max}$

Rebar (mm)	Dispenser			
	HDM 330, HDM 500	HDE 500		
$\emptyset d_s$ [mm]	$l_{v,max}$ [mm]	$l_{v,max}$ [mm]		
8	700	1000		
10		1150		
12			1300	
14				1500
16				
18	500			
20				
22				
24				
25				

Setting instruction

Dry and water-saturated concrete, hammer drilling

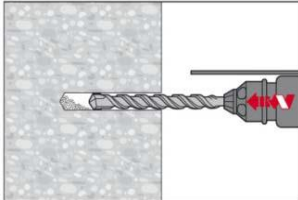
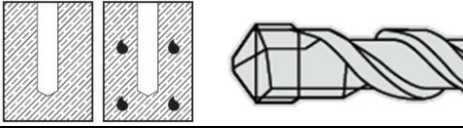

Drill hole

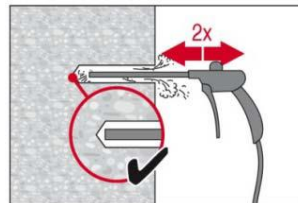
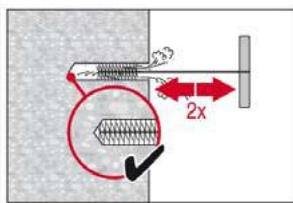
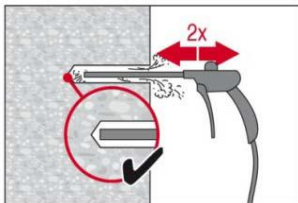

Compressed air
cleaning

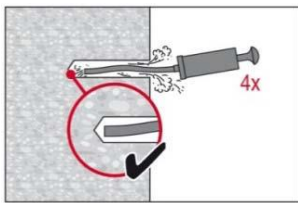
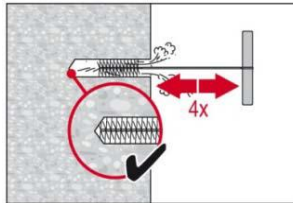
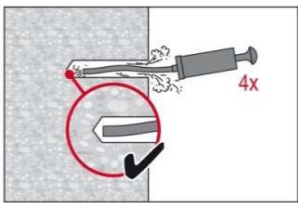

Manual cleaning for
diameters $d_0 \leq 18$ mm
and bore hole depth
 $h_0 \leq 160$ mm.

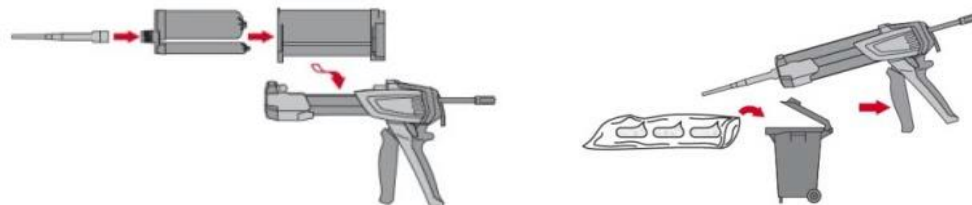

Injection system
preparation

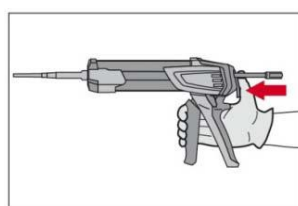
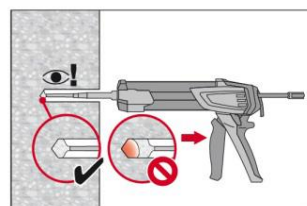

Injection method for
borehole depth
 ≤ 250 mm

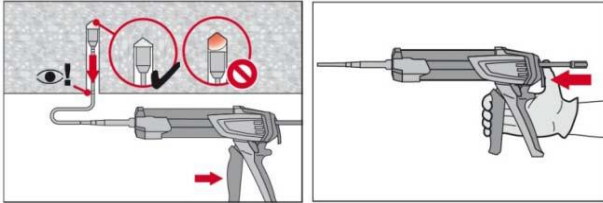

Injection method
for borehole depth
> 250 mm or overhead
applications

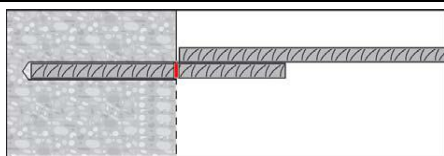
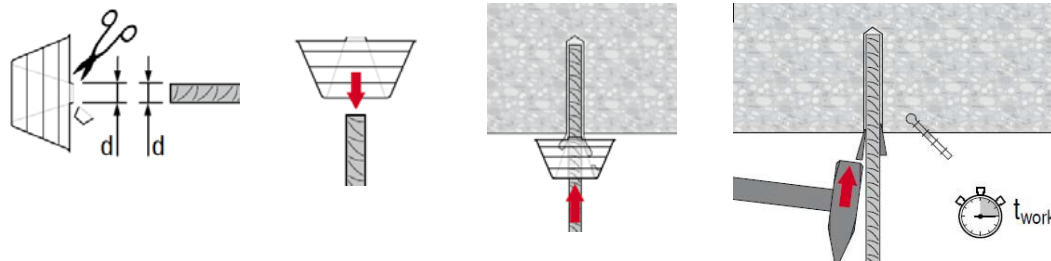

Observe the working
time "t_{work}"

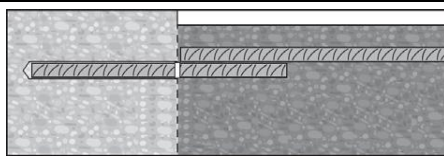

Full load may be
applied only after the
curing time "t_{cure}"

For detailed information on installation see instruction for use given with the package of the product.

Basic design data for rebar design

Bond strength in N/mm² for good bond conditions for all drilling methods

Rebar (mm)	Concrete class								
	C12/15	C16/20	C20/25	C25/30	C30/37	C35/45	C40/50	C45/55	C50/60
8 - 25	1,6	2,0	2,3	2,7	3,0	3,0	3,0	3,4	3,7

Minimum anchorage length

The minimum anchorage length $\ell_{b,min}$ and the minimum lap length $\ell_{0,min}$ according to EN 1992-1-1:2004+AC:2010 ($\ell_{b,min}$ acc. to Eq. 8.6 and Eq. 8.7 and $\ell_{0,min}$ acc. to Eq. 8.11) shall be multiplied by a factor according to Table below.

Concrete class	Drilling method	Factor
C12/15 to C25/30	Hammer drilling (HD) and compressed air drilling (CA)	1,0
C30/37		1,1
C35/45 to C40/50		1,2
C45/55 to C50/60		1,3

Service temperature range

Hilti HIT-HY 110 injection mortar may be applied in the temperature ranges given below. An elevated base material temperature may lead to a reduction of the design bond resistance.

	Base material temperature	Maximum long term base material temperature	Maximum short term base material temperature
Temperature range	-40 °C to +80 °C	+50 °C	+80 °C

Max short term base material temperature

Short-term elevated base material temperatures are those that occur over brief intervals, e.g. as a result of diurnal cycling.

Max long term base material temperature

Long-term elevated base material temperatures are roughly constant over significant periods of time.

Fitness for use

Creep behaviour

Creep tests have been conducted in accordance with national standards in different conditions:

- in wet environment at 23 °C during 90 days
- in dry environment at 43 °C during 90 days.

These tests show an excellent behaviour of the post-installed connection made with HIT-HY 110: low displacements with long term stabilisation, failure load after exposure above reference load.

Precalculated values

Example of pre-calculated values

Rebar yield strength $f_{yk} = 500 \text{ N/mm}^2$, concrete C25/30, good bond conditions

Rebar [mm]	Anchorage length l_{bd} [mm]	Design value N_{Rd} [kN]	Mortar volume [ml]	Anchorage length l_{bd} [mm]	Design value N_{Rd} [kN]	Mortar volume [ml]
$\alpha_1 = \alpha_2 = \alpha_3 = \alpha_4 = \alpha_5 = 1,0$				$\alpha_2 \text{ or } \alpha_5 = 0,7$ $\alpha_1 = \alpha_3 = \alpha_4 = 1,0$		
8	100	6,8	7,5	100	9,7	8
	170	11,5	13	140	13,6	11
	250	17,0	19	180	17,4	14
	322	21,9	24	225	21,8	17
10	121	10,3	11	121	14,7	11
	220	18,7	20	170	20,6	15
	310	26,3	28	230	27,9	21
	403	34,2	36	282	34,2	26
12	145	14,8	15	145	21,1	15
	260	26,5	27	210	30,5	22
	370	37,7	39	270	39,3	29
	483	49,2	51	338	49,1	36
14	169	20,1	20	169	28,7	20
	300	35,6	36	240	40,7	29
	430	51,1	52	320	54,3	39
	564	67,0	68	395	67,0	48
16	193	26,2	26	193	37,4	26
	340	46,1	46	280	54,3	38
	490	66,5	67	370	71,7	50
	644	87,4	87	451	87,4	61
18	218	33,3	33	218	47,5	33
	310	47,3	47	310	67,6	47
	410	62,6	62	410	89,4	62
	500	76,3	75	500	109,1	75
20	242	41,1	51	242	58,6	51
	330	56,0	70	330	80,0	70
	410	69,6	87	410	99,4	87
	500	84,8	106	500	121,2	106
22	266	49,6	75	266	70,9	75
	340	63,4	96	340	90,6	96
	420	78,4	119	420	112,0	119
	500	93,3	141	500	133,3	141
24	290	59,0	122	290	84,3	122
	360	73,3	152	360	104,7	152
	430	87,5	182	430	125,1	182
	500	101,8	211	500	145,4	211
25	302	64,0	114	302	91,5	114
	370	78,5	139	370	112,1	139
	430	91,2	162	430	130,3	162
	500	106,0	188	500	151,5	188

* Values corresponding to the minimum anchorage length. The maximum permissible load is valid for "good bond conditions" as described in EN 1992-1-1. For all other conditions multiply by the value by 0,7. The volume of mortar correspond to the formula " $1,2 \cdot (d_0^2 - d_s^2) \cdot \pi \cdot l_b / 4$ " for hammer drilling

Example of pre-calculated values for “overlap joints”

Rebar yield strength $f_{yk} = 500 \text{ N/mm}^2$, concrete C25/30, good bond conditions

Rebar [mm]	Anchorage length l_{bd} [mm]	Design value N_{Rd} [kN]	Mortar volume [ml]	Anchorage length l_{bd} [mm]	Design value N_{Rd} [kN]	Mortar volume [ml]
$\alpha_1 = \alpha_2 = \alpha_3 = \alpha_5 = \alpha_6 = 1,0$				$\alpha_2 \text{ or } \alpha_5 = 0,7$ $\alpha_1 = \alpha_3 = \alpha_6 = 1,0$		
8	200	13,6	15	200	19,4	15
	240	16,3	18	210	20,4	16
	280	19,0	21	220	21,3	17
	323	21,9	24	226	21,9	17
10	200	17,0	18	200	24,2	18
	270	22,9	24	230	27,9	21
	330	28,0	30	250	30,3	23
	402	34,1	36	281	34,1	25
12	200	20,4	21	200	29,1	21
	290	29,5	31	250	36,4	26
	390	39,7	41	290	42,2	31
	483	49,2	51	338	49,1	36
14	210	24,9	25	210	35,6	25
	330	39,2	40	270	45,8	33
	450	53,4	54	330	56,0	40
	563	66,9	68	394	66,8	48
16	240	32,6	33	240	46,5	33
	370	50,2	50	310	60,1	42
	510	69,2	69	380	73,7	52
	644	87,4	87	451	87,4	61
18	270	41,2	41	270	58,9	41
	350	53,4	53	350	76,3	53
	420	64,1	63	420	91,6	63
	500	76,3	75	500	109,1	75
20	300	50,9	64	300	72,7	64
	370	62,8	78	370	89,7	78
	430	72,9	91	430	104,2	91
	500	84,8	106	500	121,2	106
22	330	61,6	93	330	88,0	93
	390	72,8	110	390	104,0	110
	440	82,1	124	440	117,3	124
	500	93,3	141	500	133,3	141
24	360	73,3	152	360	104,7	152
	410	83,5	173	410	119,2	173
	450	91,6	190	450	130,9	190
	500	101,8	211	500	145,4	211
25	375	79,5	141	375	113,6	141
	420	89,1	158	420	127,2	158
	460	97,5	173	460	139,4	173
	500	106,0	188	500	151,5	188

* Values corresponding to the minimum anchorage length. The maximum permissible load is valid for “good bond conditions” as described in EN 1992-1-1. For all other conditions multiply by the value by 0,7. The volume of mortar correspond to the formula “ $1,2 \cdot (d_0^2 - d_s^2) \cdot \pi \cdot l_b / 4$ ” for hammer drilling

Hilti HIT-HY 100 mortar with rebar (as post-installed connection)

Injection mortar system		Benefits
	Hilti HIT-HY 100 500 ml foil pack (also available as 330 ml foil pack)	<ul style="list-style-type: none"> - suitable for concrete C 12/15 to C 50/60 - high loading capacity and fast cure - suitable for dry and water saturated concrete - for rebar diameters up to 25 mm - non corrosive to rebar elements - suitable for applications down to -10 °C - Suitable for embedment depth up to 700 mm depending on the rebar diameter
	Static mixer	
	rebar	



Concrete



European Technical Approval



CE conformity

Approvals / certificates

Description	Authority / Laboratory	No. / date of issue
European Technical Assessment ^{a)}	CSTB, France	ETA-14/0001 / 2014-02-12

a) All data given in this section according ETA-14/0001 issue 2014-02-12.

Materials

Designation	Reinforcement bars
Rebar EN 1992-1-1:2004/AC:2010, Annex C	Bars and de-coiled rods Class B or C with f_{yk} section EN 1992-1-1/NA:2013 $f_{uk} = f_{tk} = k \cdot f_{yk}$

Setting details

Working time, Curing time

Temperature of the base material T_{BM}	Working time $t_{work}^a)$	Curing time t_{cure}
$-10\text{ °C} < T_{BM} < -6\text{ °C}$	180 min	12 h
$-5\text{ °C} < T_{BM} < -1\text{ °C}$	40 min	4 h
$0\text{ °C} < T_{BM} < +4\text{ °C}$	20 min	2 h
$+5\text{ °C} < T_{BM} < +9\text{ °C}$	8 min	1 h
$+10\text{ °C} < T_{BM} < +14\text{ °C}$	7 min	50 min
$+15\text{ °C} < T_{BM} < +19\text{ °C}$	6 min	40 min
$+20\text{ °C} < T_{BM} < +24\text{ °C}$	5 min	30 min
$+25\text{ °C} < T_{BM} < +29\text{ °C}$	3 min	30 min
$+30\text{ °C} < T_{BM} \leq +40\text{ °C}$	2 min	30 min

Installation equipment

Anchor size	8	10	12	14	16	18	20	22	24	25
Rotary hammer	TE 2 – TE 40					TE 40 – TE 70				
Other tools	compressed air gun or blow out pump, set of cleaning brushes, dispenser									

Drilling diameters

Rebar (mm)	Drill bit diameters d_0 [mm]	
	Hammer drill (HD)	Compressed air drill (CA)
8	12 (10) ^{a)}	-
10	14 (12) ^{a)}	-
12	16 (14) ^{a)}	17
14	18	17
16	20	20
18	22	22
20	25	26
22	28	28
24	32	32
25	32	32

a) Values in brackets valid for maximum drilling depth of 250 mm

Dispensers and corresponding maximum embedment depth $\ell_{v,max}$

Rebar (mm)	Dispenser HDM 330, HDM 500, HDE 500 HIT-MD 2000, HIT-MD 2500 HIT-ED 3500, HIT-P300F, HIT-P3500F
$\varnothing d_s$ [mm]	$\ell_{v,max}$ [mm]
8 to 16	700
18 to 25	500

Setting instruction

Dry and water-saturated concrete, hammer drilling

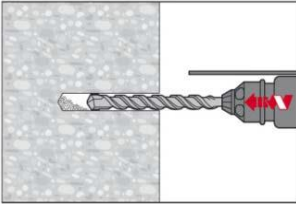
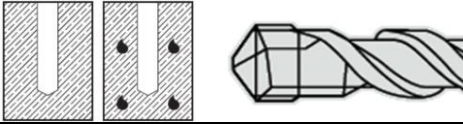

Drill hole

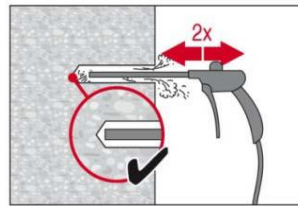
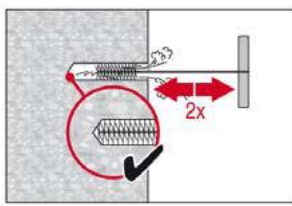
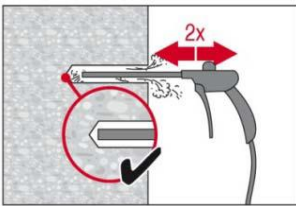

Compressed air
cleaning

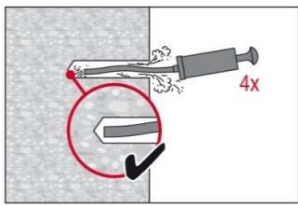
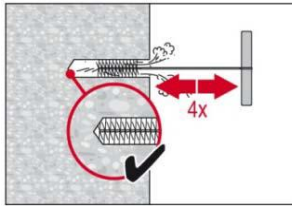
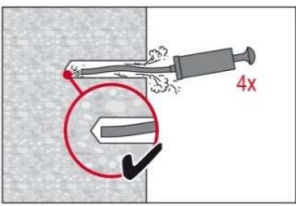

Manual cleaning for
diameters $d_0 \leq 18$
mm and bore hole
depth $h_0 \leq 160$ mm.

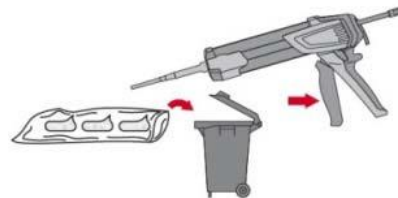
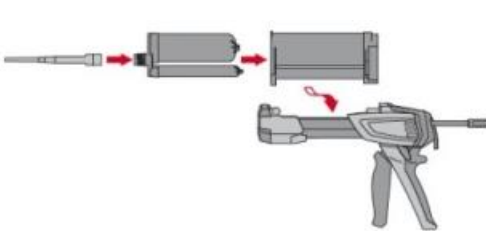

Injection system
preparation

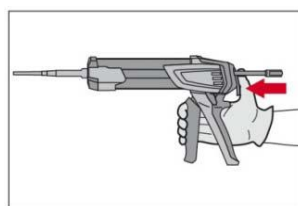
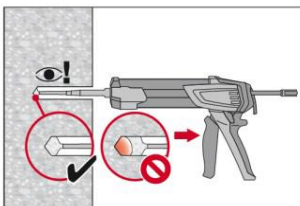

Injection method for
borehole depth ≤ 250
mm

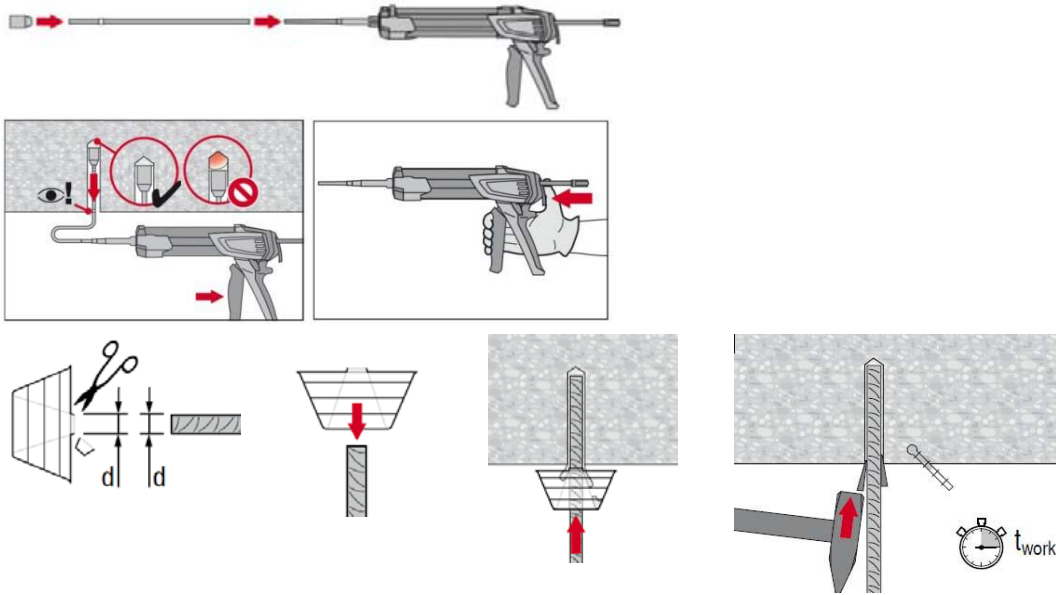

Injection method for
borehole depth > 250
mm or overhead
applications

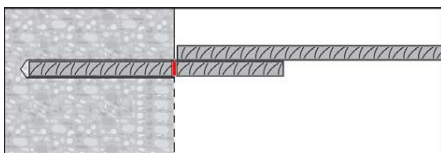

Observe the working
time "t_{work}"

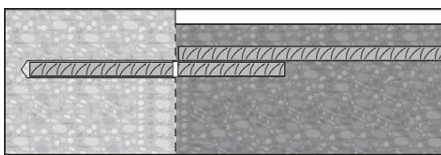

Full load may be
applied only after the
curing time "t_{cure}"

For detailed information on installation see instruction for use given with the package of the product.

Basic design data for rebar design

Bond strength in N/mm² for good bond conditions for all drilling methods

Rebar (mm)	Concrete class								
	C12/15	C16/20	C20/25	C25/30	C30/37	C35/45	C40/50	C45/55	C50/60
8 – 24	1,6	2,0	2,3	2,7	3,0	3,4	3,4	3,4	3,7
25	1,6	2,0	2,3	2,7	3,0	3,4	3,7	3,7	3,7

Minimum anchorage length

The minimum anchorage length $\ell_{b,min}$ and the minimum lap length $\ell_{0,min}$ according to EN 1992-1-1:2004+AC:2010 ($\ell_{b,min}$ acc. to Eq. 8.6 and Eq. 8.7 and $\ell_{0,min}$ acc. to Eq. 8.11) shall be multiplied by a factor according to Table below.

Concrete class	Drilling method	Factor
C12/15 to C50/60	Hammer drilling and compressed air drilling	1,5

Service temperature range

Hilti HIT-HY 100 injection mortar may be applied in the temperature ranges given below. An elevated base material temperature may lead to a reduction of the design bond resistance.

	Base material temperature	Maximum long term base material temperature	Maximum short term base material temperature
Temperature range	-40 °C to +80 °C	+50 °C	+80 °C

Max short term base material temperature

Short-term elevated base material temperatures are those that occur over brief intervals, e.g. as a result of diurnal cycling.

Max long term base material temperature

Long-term elevated base material temperatures are roughly constant over significant periods of time.

Fitness for use

Creep behaviour

Creep tests have been conducted in accordance with ETAG guideline 001 part 5 and TR 023 in the following conditions: in dry environment at 50 °C during 90 days.

These tests show an excellent behaviour of the post-installed connection made with HIT-HY 100: low displacements with long term stability, failure load after exposure above reference load.

Resistance to chemical substances

Chemical substance	Comment	Resistance
Sulphuric acid	23°C	+
Under sea water	23°C	+
Under water	23°C	+
Alkaline medium	pH = 13,2, 23°C	+

Precalculated values

Example of pre-calculated values

Rebar yield strength $f_{yk} = 500 \text{ N/mm}^2$, concrete C25/30, good bond conditions

Rebar [mm]	Anchorage length l_{bd} [mm]	Design value N_{Rd} [kN]	Mortar volume [ml]	Anchorage length l_{bd} [mm]	Design value N_{Rd} [kN]	Mortar volume [ml]
$\alpha_1 = \alpha_2 = \alpha_3 = \alpha_4 = \alpha_5 = 1,0$				$\alpha_2 \text{ or } \alpha_5 = 0,7$ $\alpha_1 = \alpha_3 = \alpha_4 = 1,0$		
8	150	10,2	11	150	14,5	11
	210	14,3	16	180	17,4	14
	260	17,6	20	200	19,4	15
	322	21,9	24	226	21,9	17
10	181	15,4	16	181	21,9	16
	260	22,1	24	210	25,4	19
	330	28,0	30	250	30,3	23
	403	34,2	36	281	34,1	25
12	218	22,2	23	218	31,7	23
	310	31,6	33	260	37,8	27
	390	39,7	41	300	43,6	32
	483	49,2	51	338	49,1	36
14	254	30,2	31	254	43,1	31
	360	42,8	43	300	50,9	36
	460	54,6	55	350	59,4	42
	564	67,0	68	394	66,8	48
16	290	39,4	39	290	56,2	39
	410	55,6	56	340	65,9	46
	530	71,9	72	400	77,6	54
	644	87,4	87	451	87,4	61
18	326	49,8	49	326	71,1	49
	380	58,0	57	380	82,9	57
	440	67,2	66	440	96,0	66
	500	76,3	75	500	109,1	75
20	363	61,6	77	363	88,0	77
	410	69,6	87	410	99,4	87
	450	76,3	95	450	109,1	95
	500	84,8	106	500	121,2	106
22	399	74,5	113	399	106,4	113
	430	80,2	122	430	114,6	122
	470	87,7	133	470	125,3	133
	500	93,3	141	500	133,3	141
24	435	88,6	184	435	126,5	184
	460	93,6	194	460	133,8	194
	480	97,7	203	480	139,6	203
	500	101,8	211	500	145,4	211
25	453	96,1	170	453	137,2	170
	470	99,7	177	470	142,4	177
	480	101,8	181	480	145,4	181
	500	106,0	188	500	151,5	188

* Values corresponding to the minimum anchorage length. The maximum permissible load is valid for "good bond conditions" as described in EN 1992-1-1. For all other conditions multiply by the value by 0,7. The volume of mortar correspond to the formula " $1,2 \cdot (d_0^2 - d_s^2) \cdot \pi \cdot l_b / 4$ " for hammer drilling



Example of pre-calculated values for “overlap joints”

Rebar yield strength $f_{yk} = 500 \text{ N/mm}^2$, concrete C25/30, good bond conditions

Rebar [mm]	Anchorage length l_{bd} [mm]	Design value N_{Rd} [kN]	Mortar volume [ml]	Anchorage length l_{bd} [mm]	Design value N_{Rd} [kN]	Mortar volume [ml]
$\alpha_1 = \alpha_2 = \alpha_3 = \alpha_5 = \alpha_6 = 1,0$				$\alpha_2 \text{ or } \alpha_5 = 0,7$ $\alpha_1 = \alpha_3 = \alpha_6 = 1,0$		
8	200	13,6	15	200	19,4	15
	240	16,3	18	210	20,4	16
	280	19,0	21	220	21,3	17
	322	21,9	24	226	21,9	17
10	200	17,0	18	200	24,2	18
	270	22,9	24	230	27,9	21
	340	28,8	31	250	30,3	23
	403	34,2	36	281	34,1	25
12	200	20,4	21	200	29,1	21
	290	29,5	31	250	36,4	26
	390	39,7	41	290	42,2	31
	483	49,2	51	338	49,1	36
14	210	24,9	25	210	35,6	25
	330	39,2	40	270	45,8	33
	450	53,4	54	330	56,0	40
	564	67,0	68	394	66,8	48
16	240	32,6	33	240	46,5	33
	370	50,2	50	310	60,1	42
	510	69,2	69	380	73,7	52
	644	87,4	87	451	87,4	61
18	270	41,2	41	270	58,9	41
	350	53,4	53	350	76,3	53
	420	64,1	63	420	91,6	63
	500	76,3	75	500	109,1	75
20	300	50,9	64	300	72,7	64
	370	62,8	78	370	89,7	78
	430	72,9	91	430	104,2	91
	500	84,8	106	500	121,2	106
22	330	61,6	93	330	88,0	93
	390	72,8	110	390	104,0	110
	440	82,1	124	440	117,3	124
	500	93,3	141	500	133,3	141
24	360	73,3	152	360	104,7	152
	410	83,5	173	410	119,2	173
	450	91,6	190	450	130,9	190
	500	101,8	211	500	145,4	211
25	375	79,5	141	375	113,6	141
	420	89,1	158	420	127,2	158
	460	97,5	173	460	139,4	173
	500	106,0	188	500	151,5	188

* Values corresponding to the minimum anchorage length. The maximum permissible load is valid for “good bond conditions” as described in EN 1992-1-1. For all other conditions multiply by the value by 0,7. The volume of mortar correspond to the formula “ $1,2 \cdot (d_0^2 - d_s^2) \cdot \pi \cdot l_b / 4$ ” for hammer drilling

Hilti HIT-CT 1 mortar with rebar (as post-installed connection)

Injection mortar system	Benefits
 <p>Hilti HIT-CT 1 330 ml foil pack (also available as 500 ml foil pack)</p>  <p>Static mixer</p>  <p>Rebar</p>	<ul style="list-style-type: none"> - Hilti Clean-Tec technology: clean of critical hazardous substances, environmentally and user friendly. - Hilti SAFEset technology: drilling with Hilti hollow drill bit and vacuum properly cleans the borehole and removes dust. No further cleaning needed. - suitable for concrete C12/15 to C50/60 - high loading capacity and fast curing - hybrid chemistry - suitable for dry and water saturated concrete - for rebar diameters up to 25 mm - non corrosive to rebar elements - good load capacity at elevated temperatures, and suitable for applications down to -5 °C

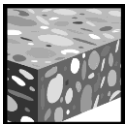

Concrete



Hilti Clean
technology



European
Technical
Approval



CE
conformity



PROFIS
Rebar
design
software



Hilti **SAFEset**
technology

Service temperature range

Temperature range: -40°C to +80°C (max. long term temperature +50°C, max. short term temperature +80°C).

Approvals / certificates

Description	Authority / Laboratory	No. / date of issue
European technical approval ^{a)}	CSTB, Paris	ETA-11/0390 / 2012-08-27
Fire test report	DiBT, Berlin	Z-21.8-2004

a) All data given in this section according ETA-11/0354 issue 2012-08-27.

Materials

Reinforcement bars according to EC2 Annex C Table C.1 and C.2N.

Properties of reinforcement

Product form		Bars and de-coiled rods	
Class		B	C
Characteristic yield strength f_{yk} or $f_{0,2k}$ (MPa)		400 to 600	
Minimum value of $k = (f_t/f_y)_k$		$\geq 1,08$	$\geq 1,15$ < 1,35
Characteristic strain at maximum force, ϵ_{uk} (%)		$\geq 5,0$	$\geq 7,5$
Bendability		Bend / Rebind test	
Maximum deviation from nominal mass (individual bar) (%)	Nominal bar size (mm) ≤ 8	$\pm 6,0$ $\pm 4,5$	
	> 8		
Bond: Minimum relative rib area, $f_{R,min}$	Nominal bar size (mm) 8 to 12	0,040	
	> 12	0,056	

Setting details

For detailed information on installation see instruction for use given with the package of the product.

Working time, Curing time

Temperature of the base material T_{BM}	Working time t_{gel}	Curing time $t_{cure}^a)$
$-5\text{ °C} \leq T_{BM} < 0\text{ °C}$	60 min	6 h
$0\text{ °C} \leq T_{BM} < 5\text{ °C}$	40 min	3 h
$5\text{ °C} \leq T_{BM} < 10\text{ °C}$	25 min	2 h
$10\text{ °C} \leq T_{BM} < 20\text{ °C}$	10 min	90 min
$20\text{ °C} \leq T_{BM} < 30\text{ °C}$	4 min	75 min
$30\text{ °C} \leq T_{BM} \leq 40\text{ °C}$	2 min	60 min

a) The curing time data are valid for dry anchorage base only. For water saturated anchorage bases the curing times must be doubled.

Setting instruction

Dry and water-saturated concrete, hammer drilling

Bore hole drilling

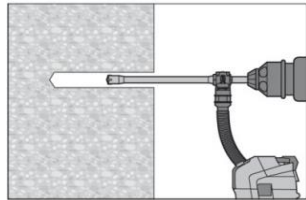

Drill hole to the required embedment depth with an appropriately sized Hilti TE-CD or TE-YD hollow drill bit with Hilti vacuum attachment. This drilling method properly cleans the borehole and removes dust while drilling. After drilling is complete, proceed to the "injection preparation" step in the instructions for use.

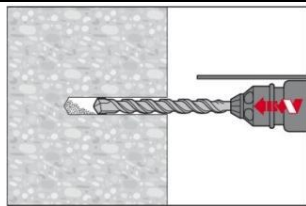

Drill hole to the required embedment depth using a hammer-drill with carbide drill bit set in rotation hammer mode, a Hilti hollow drill bit or a compressed air drill.

Bore hole cleaning

Just before setting an anchor, the bore hole must be free of dust and debris by one of two cleaning methods described below

a) Compressed air cleaning (CAC)

For all bore hole diameters d_0 and all bore hole depth h_0

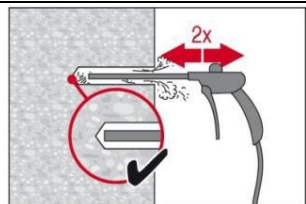

Blowing 2 times from the back of the hole with oil-free compressed air (min. 6 bar at 100 litres per minute (LPM)) until return air stream is free of noticeable dust. Bore hole diameter ≥ 32 mm the compressor must supply a minimum air flow of 140 m³/hour. If required use additional accessories and extensions for air nozzle and brush to reach back of hole.

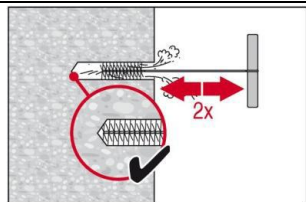

Brushing 2 times with the specified brush size (brush $\varnothing \geq$ borehole \varnothing) by inserting the round steel brush to the back of the hole in a twisting motion. The brush shall produce natural resistance as it enters the anchor hole. If this is not the case, please use a new brush or a brush with a larger diameter.

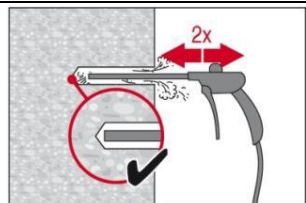

Blowing 2 times again with compressed air until return air stream is free of noticeable dust.

b) Manual Cleaning (MC)

As an alternative to compressed air cleaning, a manual cleaning is permitted for hammer drilled boreholes up to hole diameters $d_0 \leq 20\text{mm}$ and depths l_v resp. $l_{e,ges.} \leq 160\text{mm}$ or $10 \cdot d$. The borehole must be free of dust, debris, water, ice, oil, grease and other contaminants prior to mortar injection.

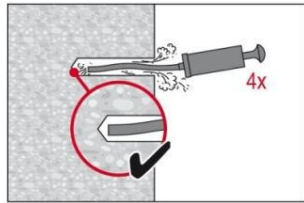

4 strokes with Hilti blow-out pump from the back of the hole until return air stream is free of noticeable dust.

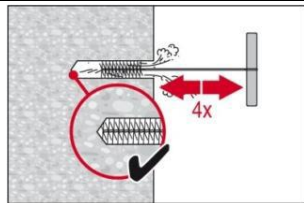

4 times with the specified brush size (brush $\varnothing \geq$ borehole \varnothing) by inserting the round steel wire brush to the back of the hole with a twisting motion. The brush shall produce natural resistance as it enters the anchor hole. If this is not the case, please use a new brush or a brush with a larger \varnothing ,

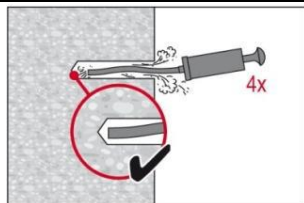

4 strokes with Hilti blow-out pump from the back of the hole until return air stream is free of noticeable dust.

Injection preparation

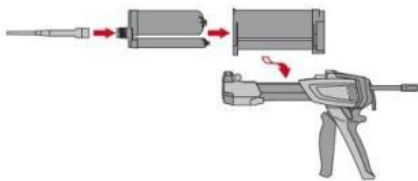

Observe the Instruction for Use of the dispenser.
Observe the Instruction for Use of the mortar.
Tightly attach Hilti HIT-RE-M mixing nozzle to foil pack manifold.
Insert foil pack into foil pack holder and swing holder into the dispenser.

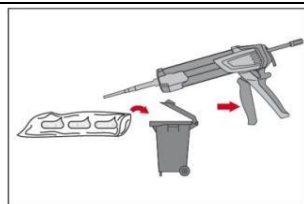

Discard initial adhesive. The foil pack opens automatically as dispensing is initiated. Depending on the size of the foil pack an initial amount of adhesive has to be discarded.

Discard quantities are
2 strokes for 330 ml foil pack
3 strokes for 500 ml foil pack

Inject adhesive from the back of the borehole without forming air voids

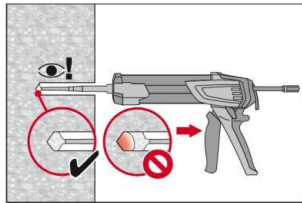

Injection method for borehole depth ≤ 250 mm:

Inject the mortar from the back of the hole towards the front and slowly withdraw the mixing nozzle step by step after each trigger pull. **Important! Use extensions for deep holes > 250 mm.** Fill holes approximately 2/3 full, or as required to ensure that the annular gap between the rebar and the concrete is completely filled with adhesive over the embedment length.

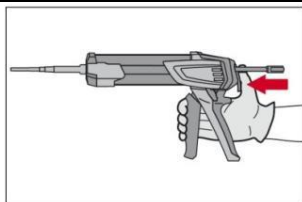

After injecting, depressurize the dispenser by pressing the release trigger (only for manual dispenser). This will prevent further mortar discharge from the mixing nozzle.

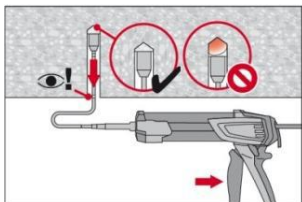

Piston plug injection for borehole depth > 250 mm or overhead applications:

Assemble mixing nozzle, extension(s) and appropriately sized piston plug. Insert piston plug to back of the hole. Begin injection allowing the pressure of the injected adhesive mortar to push the piston plug towards the front of the hole. After injecting, depressurize the dispenser by pressing the release trigger. This will prevent further mortar discharge from the mixing nozzle.

The proper injection of mortar using a piston plug HIT-SZ prevents the creation of air voids. The piston plug must be insertable to the back of the borehole without resistance. During injection the piston plug will be pressed towards the front of the borehole slowly by mortar pressure. Attention! Pulling the injection or when changing the foil pack, the piston plug is rendered inactive and air voids may occur.

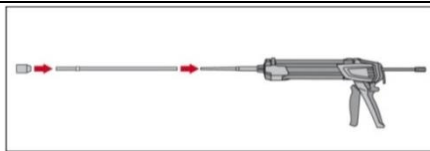

Dispenser types with related foil pack sizes:

HDM 330 Manual dispenser (330 ml)
HDM 500 Manual dispenser (330 / 500 ml)
HDE 500-A22 Electric dispenser (330 / 500 ml)

Setting the element

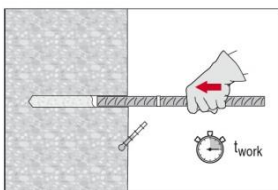

Before use, verify that the element is dry and free of oil and other contaminants.

Mark and set element to the required embedment depth until working time t_{work} has elapsed.

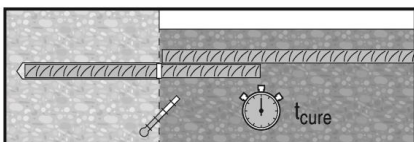

After installing the rebar the annular gap must be completely filled with mortar.

Proper installation can be verified when:

Desired anchoring embedment is reached l_v :

Embedment mark at concrete surface.

Excess mortar flows out of the borehole after the rebar has been fully inserted until the embedment mark.

Overhead application: Support the rebar and secure it from falling till mortar started to harden.

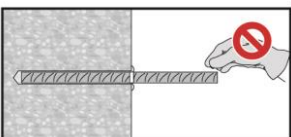

Observe the working time " t_{work} ", which varies according to temperature of base material. Minor adjustments to the rebar position may be performed during the working time. After t_{cure} preparation work may continue.

For detailed information on installation see instruction for use given with the package of the product.

Fitness for use

Creep behaviour

Creep tests have been conducted in dry environment at 50°C during 90 days.

These tests show an excellent behaviour of the post installed connection made with HIT-CT 1: low displacements with long term stabilisation, failure load after exposure above reference load.

Resistance to chemical substances

Chemical	Resistance
Acetic acid 100%	o
Acetic acid 10%	+
Hydrochloric Acid 20%	+
Nitric Acid 40%	-
Phosphoric Acid 40%	+
Sulphuric acid 40%	+
Ethyl acetate 100%	o
Acetone 100%	-
Ammoniac 5%	o
Diesel 100%	+
Gasoline 100%	+
Ethanol 96%	o
Machine oils 100%	+

Chemical	Resistance
Methanol 100%	o
Peroxide of hydrogen 30%	o
Solution of phenol (sat.)	-
Sodium hydroxide pH=14	+
Solution of chlorine (sat.)	+
Solution of hydrocarbons (60 % vol Toluene, 30 % vol Xylene, 10 % vol Methyl naphtalene)	+
Salted solution 10% sodium chloride	+
Suspension of concrete (sat.)	+
Chloroform 100%	+
Xylene 100%	+

- + resistant
- o resistant in short term (max. 48h) contact
- not resistant

Electrical Conductivity

HIT-CT 1 in the hardened state **is not conductive electrically**. Its electric resistivity is $1,4 \cdot 10^{10} \Omega \cdot m$ (DIN IEC 93 – 12.93). It is adapted well to realize electrically insulating anchorings (ex: railway applications, subway).

Drilling diameters

Rebar (mm)	Drill bit diameters d_0 [mm]	
	Hammer drill (HD)	Compressed air drill (CA)
8	12 (10 ^a)	-
10	14 (12 ^a)	-
12	16 (14 ^a)	17
14	18	17
16	20	20
20	25	26
25	32	32

a) Max. installation length $l = 250$ mm.

Basic design data for rebar design

Bond strength

**Bond strength in N/mm² according to EC2 for good bond conditions
for all drilling methods**

Rebar (mm)	Concrete class								
	C12/15	C16/20	C20/25	C25/30	C30/37	C35/45	C40/50	C45/55	C50/60
8 - 25	1,6	2,0	2,3	2,7	3,0	3,0	3,0	3,0	3,0

Minimum anchorage length

Minimum and maximum embedment depths and lap lengths for C20/25 according to ETA

The minimum anchorage length according to EC 2 shall be multiplied by the factor

- 1,0 for concrete class \leq C20/25
- 1,2 for concrete class C25/30
- 1,4 for concrete class \leq C20/25

Minimum and maximum embedment depth and lap lengths for C25/30

Rebar		Hammer drilling, Compressed air drilling		
Diameter d_s [mm]	$f_{y,k}$ [N/mm ²]	$l_{b,min}^*$ [mm]	$l_{o,min}^*$ [mm]	l_{max} [mm]
8	500	136	240	700
10	500	170	240	700
12	500	204	240	700
14	500	238	252	700
16	500	272	288	700
18	500	306	324	500
20	500	340	360	500
22	500	374	396	500
24	500	408	432	500
25	500	425	450	500

* $l_{b,min}$ (8.6) and $l_{o,min}$ (8.11) are calculated for good bond conditions with maximum utilisation of rebar yield strength $f_{yk} = 500$ N/mm² and $\alpha_6 = 1,0$

Introduction to Hilti rail anchoring systems

1 The Hilti direct fixation (DFF) generation for bottom-up, top-down, elastic and rigid applications

Hilti offers solution for both construction methods, Top-down (cast-in) and bottom up (post-installed) construction method.

Bottom-up is described as the concrete slab is poured first. The rail is set in position while all associated components are clipped to the rail besides Hilti DFF. The holes for anchors are cored in the top of the slab while the holes in the baseplates are used as drilling pattern (high accuracy). Afterwards the borehole is filled with Hilti injection mortar and Hilti DFF are inserted into the mortar filled borehole

Bottom-up construction method



Hilti direct fixation fastener



Top down is described as the rail is set and supported on props in the correct position. Baseplates and all associated components (clips, Hilti rail anchors, etc.) are clipped to the rail while the concrete is then poured up to a given level or the underside of the baseplate.

Top down construction method



Clipped components before concrete pouring



Support after concrete pouring



Hilti provides elastic fasteners if **elastomeric pads** are situated between rib plate and concrete surface. The necessary movement of the baseplate is ensured by Hilti DFF adapted with compression springs **9** which will be pre-tensioned during installation.

Hilti provides rigid systems if **no elastomeric pads** are situated between rib plate and concrete surface (tram washes, depots) where the baseplate will not move up and down in the area of the anchors. Hilti rigid rail anchors are also used if **sandwich base-plates** or so called **floating plates** should be fastened.

This boundary condition is taken into account by equipping Hilti rail anchors with spring washers (rigid) **10**

2 Hilti direct fixation fasteners ensure that major components of a modular baseplate support works

- 1 Rail to provide guide way for rolling stocks
- 2 To secure the rail to the baseplate in general two pieces of **elastic clips** fitted with electrical insulation are used. The elastic clips ensure sufficient force transfer to the rail to restrain longitudinal movement of the rail. These are attached to the baseplate via T-bolts including nut and washer.
- 3 The **rail pad** is located between the rail and baseplate to reduce abrasion as the rail moves with temperature.
- 4 The **baseplate/rib plate** may be steel iron plates which seat the rail foot and provide anchoring points for the Hilti rail anchors and clips. The baseplate also incline the rail towards the center of the track either by an angle of 1:20 or 1:40 due to the conical wheel thread of the wheels on the rail.
- 5 The **elastic pad** is providing the necessary elasticity between the baseplate and concrete slab and manages resilience in terms of noise and vibration.
- 6 **Shims** are packing pieces of varying thickness to accommodate variations in the concrete surface located between the elastic pad and concrete surface.
- 7
- 8 **Hilti direct fixation fasteners (2 or 4 pics. per baseplate) to provide a reliable load transfer from the support into the slab (concrete sleepers)**

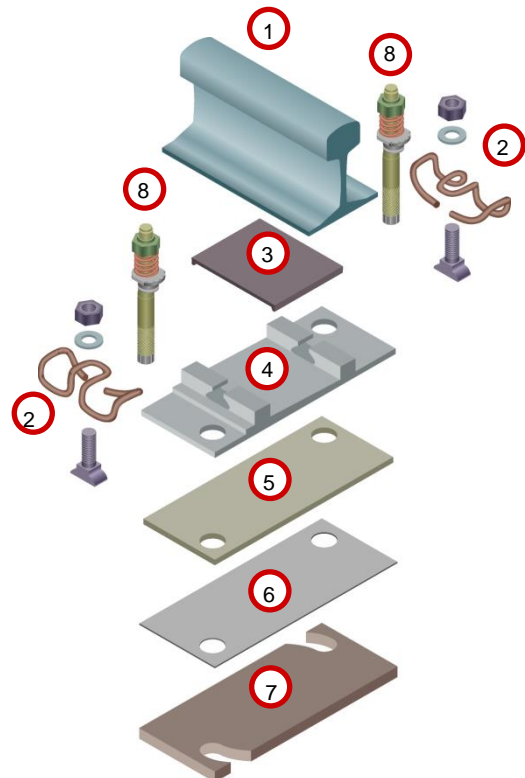

3 State-of-the art testing while Hilti direct fixation fasteners are going beyond

Hilti Rail anchors are tested by third party according to the new European standard DIN EN 13481-5 and the former standards¹⁾. Therefore Hilti rail anchors provide:

- **Sufficient fatigue resistant** (repeated loading) to ensure that the horizontal guidance forces are transferred from the rail to the base material, see section 4
- **Sufficient electrical resistance** to avoid stray current, see section 5
- the possibility of **dismantling the complete support after exposure** to severe environmental conditions
- **Sufficient tension resistance**, see section 6

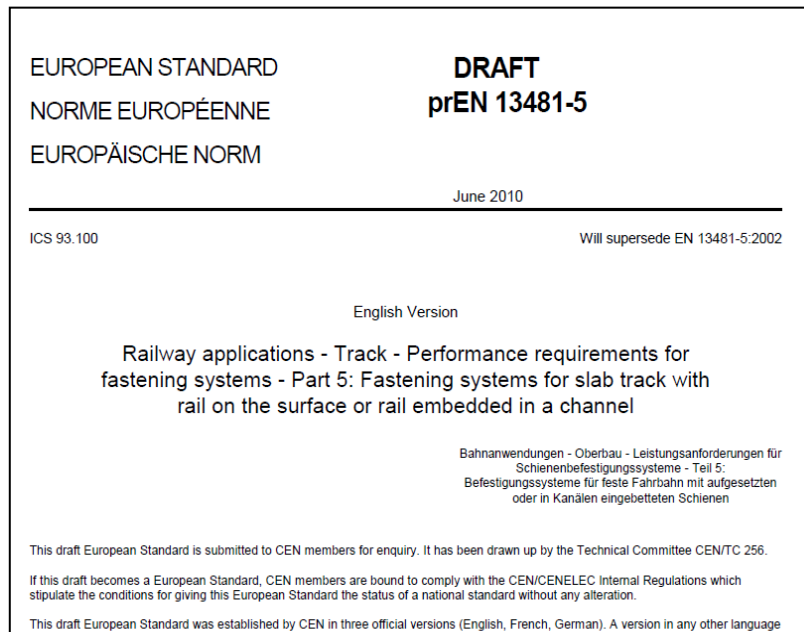

European standard for performance requirements for fastening systems – Part 5: Fastening systems for slab track with rail on the surface or rail embedded in channel

Hilti rail anchors go beyond the scope and requirements of DIN EN 13481-5 by means of tested under not expected concrete conditions (cracks in slab track), installation safety, electrical insulation and highest loads.

1) Testing recommended by the Research and Test Establishment of the International Railway association ORE or ERRI (see also CEN/TC, Part 4 «Railway applications – permanent way, test methods for fastening systems/biaxial load test, June 1996).

4 Hilti DFF keep position even under high fatigue loading

Forces acting on the rail (F_R) by rolling stock are loading Hilti direct fixation fasteners under shear by means of cantilever bending. The orientation and value of the forces are taken account by the DIN EN 13481-5 and the former standards¹⁾ in a realistic way based on axle load of the rolling stock, maximum speed and curve radii.

All Hilti rail anchor resist more than 3×10^6 load cycles under the tested boundary conditions without showing any damage.

Due to High steel strength and manufacturing quality Hilti direct fixation fasteners cover the largest lever arm possible to provide you the most flexible solution concerning load and fixing height. In general only 2 anchors per baseplate are needed (straight track). This results in less installation time and costs in combination with a reliable solution.

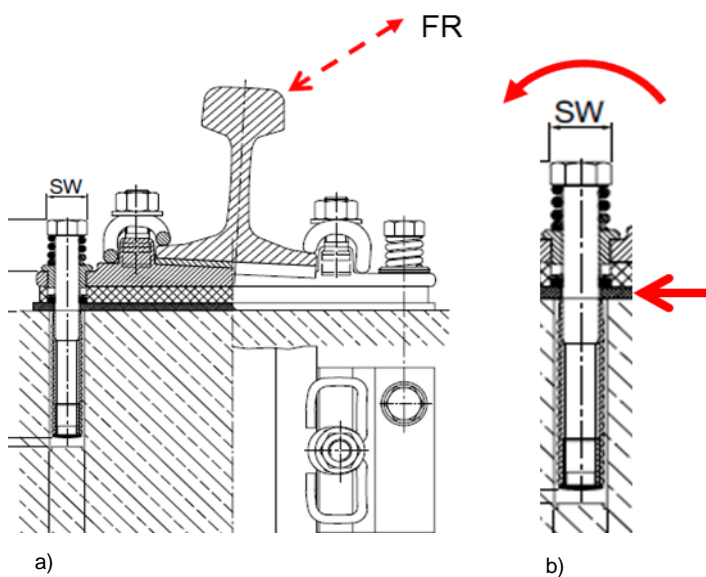

a) Cross section and inclined load F_R by rolling stock
 b) Cantilever bending of Hilti direct fixation fasteners by means of shear force and moment

Hilti rail anchor goes beyond !

While the axle load of DIN EN 13481-5 is limited to 250 kN (25tons), Hilti showed that the HRC rail anchor family resists axle loads up to 390 kN (39tons) without showing any damage.

We do not believe in plastic if it comes to load transfer

All parts of Hilti rail anchors which are taking up tension load and/or bending moment are made out of high strength steel to ensure a reliable load transfer mechanism.

5 Hilti rail anchors brings electrical current to the intended path

Stray currents can be described as electrical current which do not follow the intended path. Effectively stray currents are electrical charges leaking into the ground while the hazard of stray currents emerges whenever this rogue DC charge comes into contact with anything metallic, whereupon it will begin the corrosion process (e.g. pipes).

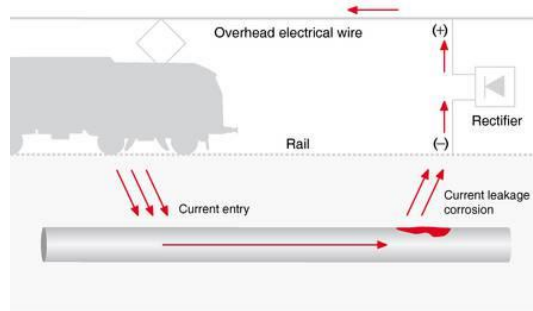

Stray current acting on a metallic pipe

One part of reducing stray current such as rail-to-earth resistance can be controlled via Hilti rail anchors by combining Hilti electrical resistance mortar (HIT RE 500 & HIT RE 500 SD) with Hilti electrical resistance collar bushes.

The European standard is measuring the electrical insulation during test, the minimum required resistance value is $R_{33} = 5.0\text{k}\Omega$ (wet conditions),

With Hilti rail anchors always $5.0\text{k}\Omega < R_{33} \leq 33\text{k}\Omega$ were achieved based on the used system.

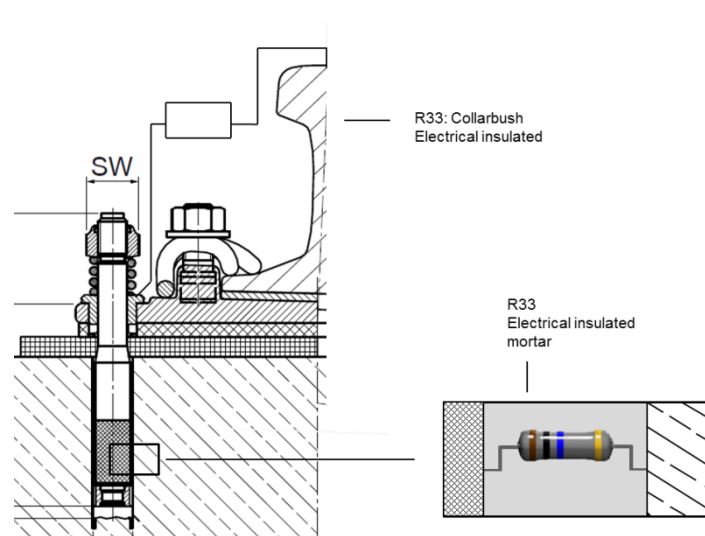



6 The state-of the art testing standard DIN EN 13481-5

According to DIN EN 13481-5 "Railway applications – Track – Performance requirements for fastening systems – Part 5: Fastening systems for slab track with rail on surface or rail embedded in a channel", direct fixation fasteners should in addition resist a tension load of 60 kN for 3 minutes. However it is not clearly stated if these pullout tests should be performed after or before the fatigue tests by means of 3 Mio. load cycles.

This is clear for us. Providing top quality direct fixation fasteners Hilti performs the discussed pullout test after and with the already fatigue loaded anchor to take account of all conditions in a realistic way

With Hilti direct fixation fasteners pullout loads of up to 150 kN after fatigue loading are measured.

HRT-WH Rail anchor with Hilti HVU or Hilti HIT-RE 500

Fastening system	Benefits
 <p>Hilti HRT-WH</p>	<ul style="list-style-type: none"> - for fastening rails to concrete slab track - for bottom-up (post-installed) construction method - verified for axle loads up to 250 kN - high electrical insulation values concerning stray current - corrosion resistance -- additional sizes and accessories available - chisel point - setting through rib plate possible - different support stiffness - complete installation and system portfolio - 2 and 4 anchor configuration
 <p>Hilti HIT-RE 500 330 ml foil pack (also available as 500 ml and 1400 ml foil pack)</p>	
 <p>Hilti HVU foil capsule</p>	

Approvals / certificates

Description	Authority / Laboratory	No. / date of issue
Rail anchor testing	Technical University of Munich	Report no. 1893 / 2001-05-06

Application field covered

Selection of Hilti rail anchors for fastening rails to concrete track slab, based on axle load (A), stiffness (c) and thickness (t) of elastic pad

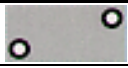
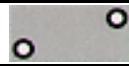
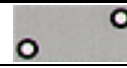
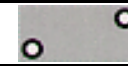
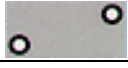
Anchor *	Elastic pad, t (mm)**	Tramway A = 100 kN	Metro A = 135 kN	Commuter A = 170 kN	Full Size A = 250 kN
HRT-WH M22x200	10				
	20				
Criteria	V _{max}	60 km/h	80 km/h	120 km/h	≥ 250 km/h
	R _{min} (V _{max})***	70 m (25 km/h)	200 m (60 km/h)	350 m (80 km/h)	3000 m
	Support spacing	750 mm	750 mm	700 mm	650 mm

* Configuration of base plate (support):  -> = Anchors per support

** Stiffness of elastic pad:
t = 10mm -> c = 20-30 kN/mm
t = 20mm -> c = 10-20 kN/mm

*** Indicative value: V_{max} is a function of the existing superelevation (cant) and the lateral acceleration.

Setting details	HRT WH 22x200		
	Hilti mortar type	HVU M20x110	HIT-RE 500
	Nominal diameter of drill bit d_0 [mm]	25	
	Nominal drilling depth h_1 [mm]	120	110
	Embedment depth h_{nom} [mm]	110	
	Minimum member thickness h_{min} [mm]	200	
	Length of anchor l [mm]	200	
	Maximum fixing height t_{fix} [mm]	35	
	Spring deflection S_{inst} [mm]	5	
	Spring length L_{st} [mm]	22	
	Wrench size S_{inst} [mm]	32	

Curing time for general conditions HVU capsule

Temperature of the base material	Curing time before anchor can be fully loaded t_{cure}
20 °C to 40 °C	20 min
10 °C to 19 °C	30 min
0 °C to 9 °C	1 h
-5 °C to - 1 °C	5 h



Curing time for general conditions HIT-RE 500

Temperature of the base material	Curing time before anchor can be fully loaded t_{cure}
40 °C	4h
30 °C to 39 °C	8h
20 °C to 29 °C	12h
15 °C to 19 °C	24h
10 °C to 14 °C	48h
5 °C to 9 °C	72h

Specification

HRT-WH Rail Anchor	
	<p>Stopnut (M22-SW32) Material: 5S (DIN 985, EN ISO 7040, DIN 267), blue zinc plated: Fe/Zn 5B (DIN 50961) Fixing device: Nylon, torque force 68 Nm Service temperature: -50°C up to 120°C</p>
	<p>Washer (24/39/3 mm) Material: Steel grade 4.6 (DIN 126), blue zinc plated: Fe/Zn 5B (DIN 50961)</p>
	<p>Double coil Spring Fe 6 Material: Spring steel, Int. Ø= 24 mm, Ext. Ø= 44 mm, original height: 22 mm, compressed height: 17 mm, cathaphoretic coating 7 µ</p>
	<p>Collar Bush (Sealing Lip) Material: Plastic, int. Ø= 22 mm, ext. Ø= 36 mm Volume resistivity: $1.2 \times 10^{12} \Omega \text{ cm}$ Flexible lower portion of collar bush to prevent any excess injection mortar HIT-RE or foilcapsule (HVU) from restricting managed system compression</p>
	<p>Anchor Body (Ø 22 mm) High grade steel (DIN/ISO 898/1) Blue zinc plated: Fe/Zn 10B (DIN 50961) Designed to withstand high axle loads of 250 kN, cone heads fits setting tool TE-Y-E M20 to set the anchor with the HVU foil capsule</p>
	<p>Thread (M22) To provide adequate bonding with foil capsule HVU or HIT-RE 500 mortar and transfer tension loading to the lower part of the concrete slab</p>
<p>Chisel Point To provide adequate mixing of the HVU foil capsule and to transfer the torsionloading via the mortar to the concrete</p>	

HRT Rail anchor with Hilti HIT-RE 500

Fastening system	Benefits
 <p>Hilti HRT</p>  <p>Hilti HIT-RE 500 330 ml foil pack (also available as 500 ml and 1400 ml foil pack)</p>	<ul style="list-style-type: none"> - for fastening rails to concrete slab track - for bottom-up (post-installed) construction method - verified for axle loads up to 170 kN - high electrical insulation values concerning stray current - corrosion resistance - for diamond core drilled holes with roughening - additional sizes and accessories available - setting through rib plate possible - different support stiffness - complete installation and system portfolio - 2 and 4 anchor configuration

Approvals / certificates

Description	Authority / Laboratory	No. / date of issue
Rail anchor testing	Technical University of Munich	Report no. 1584a / 1995-08-15
		Report no. 1726 / 1998-04-04

Application field covered

Selection of Hilti rail anchors for fastening rails to concrete track slab, based on axle load (A), stiffness (c) and thickness (t) of elastic pad

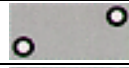
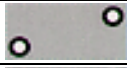
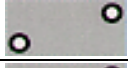
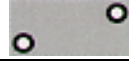
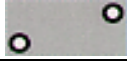
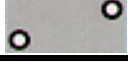
Anchor *	Elastic pad, t (mm)**	Tramway A = 100 kN	Metro A = 135 kN	Commuter A = 170 kN	Full Size A = 250 kN
HRT M22x215	10				
	20				
	30				
Criteria	V_{max}	60 km/h	80 km/h	120 km/h	≥ 250 km/h
	$R_{min}(V_{max})^{***}$	70 m (25 km/h)	200 m (60 km/h)	350 m (80 km/h)	3000 m
	Support spacing	750 mm	750 mm	700 mm	650 mm

* Configuration of base plate (support):  -> = Anchors per support

** Stiffness of elastic pad:
 t = 10mm -> c = 20-30 kN/mm
 t = 20mm -> c = 10-20 kN/mm
 t = 30mm -> c = 5-10 kN/mm

*** Indicative value: V_{max} is a function of the existing superelevation (cant) and the lateral acceleration.

Setting details	HRT WH 22x200	
	Anchor size	M22
	Hilti mortar type	HIT-RE 500
	Nominal diameter of drill bit d_0 [mm]	25
	Nominal drilling depth h_1 [mm]	110
	Embedment depth h_{nom} [mm]	106
	Minimum member thickness h_{min} [mm]	160
	Length of anchor l [mm]	215
	Maximum fixing height t_{fix} [mm]	40
	Spring deflection S_{inst} [mm]	8
	Spring length L_{st} [mm]	35
	Wrench size S_{inst} [mm]	38



Curing time for general conditions HIT-RE 500

Temperature of the base material	Curing time before anchor can be fully loaded t_{cure}
40 °C	4h
30 °C to 39 °C	8h
20 °C to 29 °C	12h
15 °C to 19 °C	24h
10 °C to 14 °C	48h
5 °C to 9 °C	72h

Specification

	<p>Hilti HRT Rail Anchor</p> <p>Stopnut (M22-SW32) Material: 5S (DIN 985, EN ISO 7040, DIN 267), blue zinc plated: Fe/Zn 5B (DIN 50961) Fixing device : Nylon, torque force 68 Nm Service temperature: -50°C up to 120°C</p> <p>Spring 35mm Wire grade: C7 (DIN 2076), yellow zinc plated: Fe/Zn 7C (DIN 50961) Spring rate: 373 N/mm Deformation: 8mm → 3.0 kN compression</p> <p>Collar Bush (Sealing Lip) Material: Plastic, int. Ø= 22 mm, ext. Ø= 36 mm Volume resistivity: $1.2 \times 10^{12} \Omega \text{ cm}$ Flexible lower portion of collar bush to prevent any excess injection mortar from restricting managed system compression</p> <p>Anchor Body (Ø 22 mm) Material: High grade carbon steel (DIN/ISO 898/1) Yellow zinc plated: Fe/Zn 10C (DIN 50961) Designed to withstand high dynamic loads resulting from train axle loads up to 170 kN</p> <p>Knurling To provide adequate bonding with HIT-RE 500 mortar and transfer tension and torsion loadings to the lower part of the concrete slab</p> <p>Centering Bush To centrally locate the anchor within the cored hole to provide an uniform wrapping of the anchor rod with the injection mortar. To avoid the contact between the concrete slab reinforcement and the anchor body</p>
--	---

HRC / HRC-DB Rail anchor with Hilti HIT-RE 500

Fastening system	Benefits
 <p>Hilti HRC</p>	<ul style="list-style-type: none"> - for fastening rails to concrete slab track - for bottom-up (post-installed) construction method - verified for axle loads up to 250 kN - high electrical insulation values concerning stray current - corrosion resistance - additional sizes and accessories available - horizontal adjustment when used with ex-center collar bush - different support stiffness - complete installation and system portfolio - 2 and 4 anchor configuration
 <p>Hilti HRC-DB</p>	
 <p>Hilti HIT-RE 500 330 ml foil pack (also available as 500 ml and 1400 ml foil pack)</p>	





Approvals / certificates

Description	Authority / Laboratory	No. / date of issue
Rail anchor testing	Technical University of Munich	Report no. 1584b / 1995-08-15
		Report no. 1584d / 1995-08-15
		Report no. 1609 / 1995-12-06
EBA approval ^{a)}	German Federal Railway Office	21.62 lozb (561/00) / 2001-05-29

a) EBA approval (HRC-DB), shimming up to 25mm to take account of settlement

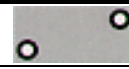
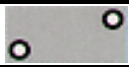
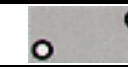
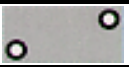
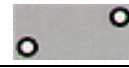
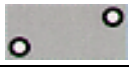
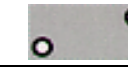
Application field covered

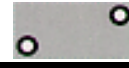
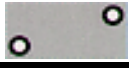
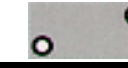
Selection of Hilti rail anchors for fastening rails to concrete track slab, based on axle load (A), stiffness (c) and thickness (t) of elastic pad

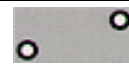
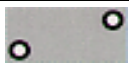
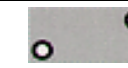
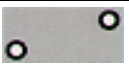
Anchor *	Elastic pad, t (mm)**	Tramway A = 100 kN	Metro A = 135 kN	Commuter A = 170 kN	Full Size A = 250 kN
HRC M22x215	10				
	20				
	30				
HRC-DB M22x225	10 +26mm shim				
Criteria	V_{max}	60 km/h	80 km/h	120 km/h	≥ 250 km/h
	$R_{min}(V_{max})^{***}$	70 m (25 km/h)	200 m (60 km/h)	350 m (80 km/h)	3000 m
	Support spacing	750 mm	750 mm	700 mm	650 mm

* Configuration of base plate (support):  -> = Anchors per support

** Stiffness of elastic pad:
 t = 10mm -> c = 20-30 kN/mm
 t = 20mm -> c = 10-20 kN/mm
 t = 30mm -> c = 5-10 kN/mm

*** Indicative value: V_{max} is a function of the existing superelevation (cant) and the lateral acceleration.

Setting details	HRC M22x215 / HRC-DB M22x225		
	Anchor	HRC M22	HRC-DB M22
	Hilti mortar type	HIT-RE 500	
	Nominal diameter of drill bit d_0 [mm]	30	
	Nominal drilling depth h_1 [mm]	110	
	Embedment depth h_{nom} [mm]	106	
	Minimum member thickness h_{min} [mm]	160	
	Length of anchor l [mm]	215	225
	Maximum fixing height t_{fix} [mm]	40	50
	Spring deflection S_{inst} [mm]	8	
	Spring length L_{st} [mm]	35	
	Wrench size S_{inst} [mm]	38	

Curing time for general conditions HIT-RE 500

Temperature of the base material	Curing time before anchor can be fully loaded t_{cure}
40 °C	4h
30 °C to 39 °C	8h
20 °C to 29 °C	12h
15 °C to 19 °C	24h
10 °C to 14 °C	48h
5 °C to 9 °C	72h

Specification

Hilti HRC Rail Anchor



Stopnut (M22-SW32)

Material: 5S (DIN 985, EN ISO 7040, DIN 267), blue zinc plated: Fe/Zn 5B (DIN 50961)

Fixing device : Nylon, torque force 68 Nm

Service temperature: -50°C up to 120°C

Spring 35mm

Wire Grade: C7 (DIN 2076), Yellow Zinc Plated: Fe/Zn 7C (DIN 50961)

Spring Rate: 373 N/mm

Deformation: 8mm → 3.0 kN compression

Collar Bush (Sealing Lip)

Material: Plastic, int. Ø= 22 mm, ext. Ø= 36 mm

Volume Resistivity: $1.2 \times 10^{12} \Omega \text{ cm}$

Flexible lower portion of collar bush to prevent any excess injection mortar from restricting managed system compression

Anchor Body (Ø 22 mm)

Material: High grade carbon steel (DIN/ISO 898/1), yellow zinc plated: Fe/Zn 10C (DIN 50961)

Designed to withstand high dynamic loads resulting from train axle loads up to 250 kN





Knurling

To provide adequate bonding with HIT-RE/HY mortar and transfer tension and torsion loadings to the lower part of the concrete slab

Centering Bush

To centrally locate the anchor within the cored hole to provide an uniform wrapping of the anchor rod with the injection mortar. To avoid the contact between the concrete slab reinforcement and the anchor body

HRA Rail anchor with Hilti HIT-RE 500 or HVU-G/EA glass capsule

Fastening system	Benefits
 <p>Hilti HRA, type a</p>	<ul style="list-style-type: none"> - for fastening rails to concrete slab track - for bottom-up (post-installed) construction method - verified for axle loads up to 250 kN - high electrical insulation values concerning stray current - corrosion resistance -- with spring or double coil spring - additional sizes and accessories available - different support stiffness - complete installation and system portfolio - 2 and 4 anchor configuration
 <p>Hilti HRA, type b</p>	
 <p>Hilti HIT-RE 500 330 ml foil pack (also available as 500 ml and 1400 ml foil pack)</p>	
 <p>Hilti HVU-G/EA glass capsule</p>	

Approvals / certificates

Description	Authority / Laboratory	No. / date of issue
Rail anchor testing	Technical University of Munich	Report no. 1584c / 1995-08-15
		Report no. 1584d / 1995-08-15

Application field covered

Selection of Hilti rail anchors for fastening rails to concrete track slab, based on axle load (A), stiffness (c) and thickness (t) of elastic pad

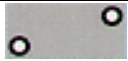
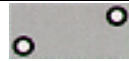
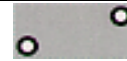
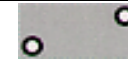
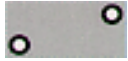
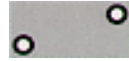
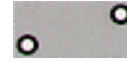
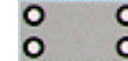
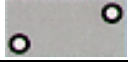
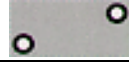
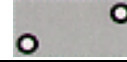
Anchor *	Elastic pad, t (mm)**	Tramway A = 100 kN	Metro A = 135 kN	Commuter A = 170 kN	Full Size A = 250 kN
HRA M22x220a M22x220b M22x270 M22x310	10				
	20				
	30				
Criteria	V_{max}	60 km/h	80 km/h	120 km/h	≥ 250 km/h
	$R_{min}(V_{max})^{***}$	70 m (25 km/h)	200 m (60 km/h)	350 m (80 km/h)	3000 m
	Support spacing	750 mm	750 mm	700 mm	650 mm

* Configuration of base plate (support):  -> = Anchors per support

** Stiffness of elastic pad:
 t = 10mm -> c = 20-30 kN/mm
 t = 20mm -> c = 10-20 kN/mm
 t = 30mm -> c = 5-10 kN/mm

*** Indicative value: V_{max} is a function of the existing superelevation (cant) and the lateral acceleration.

Setting details	HRA M22				
	Anchor	HRA M22			
		220a	220b	270	310
	Hilti mortar type	HIT-RE 500 HVU-G/EA glass capsule			
	Nominal diameter of drill bit d_0 [mm]	35			
	Nominal drilling depth h_1 [mm]	120	120	130	130
	Embedment depth h_{nom} [mm]	110	110	125	125
	Minimum member thickness h_{min} [mm]	160			
	Length of anchor l [mm]	220	220	270	310
	Maximum fixing height t_{fix} [mm]	50	40	65	105
	Spring deflection S_{inst} [mm]	5	8	12	12
	Spring length L_{st} [mm]	22	35	55	55
	Wrench size S_{inst} [mm]	38			

Curing time for dry conditions HVU-G/EA glass capsule

Temperature of the base material	Curing time before anchor can be fully loaded t_{cure}
30 °C	20 min
20 °C to 29 °C	30 min
10 °C to 19 °C	1,5 h
-5 °C to 9 °C	6 h

The curing time data for water saturated anchorage bases must be doubled

Curing time for general conditions HIT-RE 500

Temperature of the base material	Curing time before anchor can be fully loaded t_{cure}
40 °C	4h
30 °C to 39 °C	8h
20 °C to 29 °C	12h
15 °C to 19 °C	24h
10 °C to 14 °C	48h
5 °C to 9 °C	72h

Specification

Hilti HRA Rail Anchor, type a	
	<p>Stopnut (M22-SW38) Material; 5S (DIN 982), Zinc plated Fe/Zn 7C (DIN 50961)</p>
	<p>Spring (35mm/55mm) Wire Grade: C7 (DIN 2076), yellow zinc plated: Fe/Zn 7C (DIN 50961) Spring Rate: 373 N/mm</p>
	<p>Washer (W 24 x39 x 3 mm) Zinc plated Fe/ZN 5B (DIN 50961)</p>
	<p>Collar Bush Material; Plastic, int Ø= 28 mm, ext Ø= 35.5 mm Electrical Insulation; $3.5 \times 10^{12} \Omega$</p>
	<p>Plastic Wrapping Designed to eliminate stray current loss. Ext Ø= 32 mm</p>
	<p>Anchor Body High grade carbon steel. Designed to withstand high dynamic loads resulting from train axle loads up to 250 kN</p>
	<p>Bonding Ribs To provide adequate bonding with injection mortar HIT-RE 500 mortar and HVU-G/EA capsule</p>
<p>Chisel Point To provide torsional resistance and ensure mixing of HVU-G/EA capsule</p>	

Hilti HRA Rail Anchor, type b**Stopnut (M22-SW38)**

Material; 5S (DIN 982), Zinc plated Fe/Zn 7C (DIN 50961)

Double coilSpring Fe 6 (22 mm)

Spring steel, Int Ø= 24mm, Ext Ø= 44 mm, Original Height: 22mm
Compressed Height: 17mm, Cathaphoretic coatings 7 µ

Washer (W 24 x39 x 3 mm)

Zinc plated Fe/ZN 5B (DIN 50961)

Collar Bush

Material; Plastic, int Ø= 28 mm, ext Ø= 35.5 mm
Electrical Insulation; $3.5 \times 10^{12} \Omega$

Plastic Wrapping

Designed to eliminate stray current loss. Ext Ø= 32 mm

Anchor Body

High grade carbon steel. Designed to withstand high dynamic loads
resulting from train axle loads up to 250 kN

Bonding Ribs



To provide adequate bonding with injection mortar HIT-RE 500 mortar and
HVU-G/EA capsule

Chisel Point

To provide torsional resistance and ensure mixing of HVU-G/EA capsule



HRT-I Rail anchor with Hilti HIT-RE 500

Fastening system	Benefits
 <p>Hilti HRT-I (rigid)</p>	<ul style="list-style-type: none"> - for fastening rails to concrete slab track - for bottom-up (post-installed) construction method - verified for axle loads up to 250 kN - high electrical insulation values concerning stray current - corrosion resistance - with spring (elastic) or spring washer (rigid) - additional sizes and accessories available - bolt removable - different support stiffness - complete installation and system portfolio - 2 and 4 anchor configuration
 <p>Hilti HRT-I (elastic)</p>	
 <p>Hilti HIT-RE 500 330 ml foil pack (also available as 500 ml and 1400 ml foil pack)</p>	

Approvals / certificates

Description	Authority / Laboratory	No. / date of issue
Rail anchor testing	Technical University of Munich	Report no. 2824 / 2011-12-21
		Report no. 2883 / 2012-05-21

Application field covered

Selection of Hilti rail anchors for fastening rails to concrete track slab, based on axle load (A), stiffness (c) and thickness (t) of elastic pad

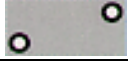
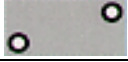
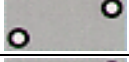
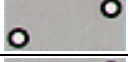
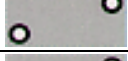
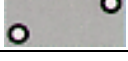
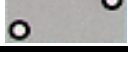
Anchor *	Elastic pad, t (mm)**	Tramway A = 100 kN	Metro A = 135 kN	Commuter A = 180 kN	Full Size A = 250 kN
HRT- I M22	15				-
	25				-
HRT- I M27	10				
	20				
	30				-
Criteria	V_{max}	60 km/h	80 km/h	120 km/h	≥ 250 km/h
	$R_{min}(V_{max})^{***}$	70 m (25 km/h)	200 m (60 km/h)	300 m (80 km/h)	3000 m
	Support spacing	750 mm	750 mm	700 mm	650 mm

* Configuration of base plate (support):  -> = Anchors per support

** Stiffness of elastic pad:
 t = 10mm -> c = 20-30 kN/mm
 t = 20mm -> c = 10-20 kN/mm
 t = 30mm -> c = 5-10 kN/mm

*** Indicative value: V_{max} is a function of the existing superelevation (cant) and the lateral acceleration.

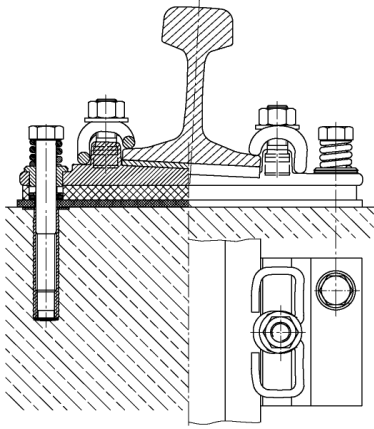
Setting details	HRT-I-M22x190/HRT-I M27x240		
	Anchor	HRT-I M22	HRT-I M27
	Hilti mortar type	HIT-RE 500	
	Nominal diameter of drill bit d_0 [mm]	32	35
	Nominal drilling depth h_1 [mm]	125	155
	Embedment depth h_{nom} [mm]	120	150
	Minimum member thickness h_{min} [mm]	-	
	Length of anchor l [mm]	160	200
	Maximum fixing height t_{fix} [mm]	-	-
	Spring deflection S_{inst} [mm]	8	10
	Spring length L_{st} [mm]	35	40
	Wrench size S_{inst} [mm]	32	41

Curing time for general conditions HIT-RE 500

Temperature of the base material	Curing time before anchor can be fully loaded t_{cure}
40 °C	4h
30 °C to 39 °C	8h
20 °C to 29 °C	12h
15 °C to 19 °C	24h
10 °C to 14 °C	48h
5 °C to 9 °C	72h

Specification

Hilti HRT-I (elastic) Rail Anchor		
	<p>Bolt (M22, SW32) Material: 10.9 (DIN 931, EN ISO 4014), hot dipped galvanized Head: Hexagonal</p>	<p>Bolt (M27, SW41) Material: 8.8 (DIN 931, EN ISO 4014), blue zinc plated: Fe/Zn 10B (DIN 50961) Head: Hexagonal</p>
	<p>Spring (35 mm) Wire Grade: C7 (DIN 2076), Yellow Zinc Plated: Fe/Zn 7C (DIN 50961), spring Rate: 373 N/mm, deformation: 8mm</p>	<p>Spring (40 mm) Wire Grade: C7 (DIN 2076), yellow zinc plated: Fe/Zn 7C (DIN 50961), spring Rate: 300 N/mm, deformation: 10mm → 3.0 kN compression</p>
	<p>Collar Bush (Sealing Lip) Material: Plastic, Int. Ø= 23 mm, Ext. Ø= 36 mm Volume resistivity: $1.2 \times 10^{12} \Omega \text{ cm}$ Flexible lower portion of collar bush to prevent any excess injection mortar HIT-RE on the anchor shaft</p>	<p>Collar Bush (Sealing Lip) Material: Plastic, int. Ø= 28 mm, ext. Ø= 36 mm Volume Resistivity: $1.2 \times 10^{12} \Omega \text{ cm}$ Flexible lower portion of collar bush to prevent any excess injection mortar HIT-RE on the anchor shaft</p>
	<p>Sealingwasher (22.0/36.0/5.0) To prevent any excess injection mortar HIT-RE on the anchor shaft.</p>	<p>Sealingwasher (27.0/36.0/5.0) To prevent any excess injection mortar HIT-RE on the anchor shaft.</p>
	<p>Insert Body Ø 28 mm Material: carbon steel (DIN/ISO 898/1), blue zinc plated: Fe/Zn 10B (DIN 50961), designed for an embedment of 120 mm</p>	<p>Insert Body Ø 33 mm Material: carbon steel (DIN/ISO 898/1), blue zinc plated: Fe/Zn 10B (DIN 50961), designed for an embedment of 150 mm</p>

Hilti HRT-I (rigid) Rail Anchor

Bolt (M22, SW32)

Material: 10.9 (DIN 931, EN ISO 4014), hot dipped galvanized
Head: Hexagonal

Spring washer (22.5/35.9/4.0)

Wire Grade: C7 (DIN 2076), blue zinc plated: Fe/Zn 10B (DIN 50961), deformation: 4mm

Washer (23.0/44.0/4.0)

Material: 4.8 (DIN 125), blue zinc plated: Fe/Zn 10B (DIN 50961)
Int. Ø= 23 mm, Ext. Ø= 44 mm

Collar Bush

Material: Plastic, int. Ø: 22.2 mm, ext. Ø: 24.2 mm; collar Ø: 44 mm, height: 2/12/14 mm to provide insulation against stray current.

Sealingwasher (22.0/36.0/5.0)

PE-Hard foam LD29, black, to prevent any excess injection mortar HIT-RE on the anchor shaft.

Insert Body (Ø 28 mm)

Material: carbon steel (DIN/ISO 898/1), blue zinc plated: Fe/Zn 10B (DIN 50961), designed for an embedment of 120 mm

Bolt (M27, SW41)

Material: 8.8 (DIN 931, EN ISO 4014), blue zinc plated: Fe/Zn 10B (DIN 50961)
Head: Hexagonal

Spring washer (27.5/41.5/5.0)

Wire Grade: C7 (DIN 2076), blue zinc plated: Fe/Zn 10B (DIN 50961), deformation: 4mm

Washer (28.0/49.0/4.0)

Material: 4.8 (DIN 125), blue zinc plated: Fe/Zn 10B (DIN 50961)
Int. Ø= 28 mm, Ext. Ø= 49 mm

Collar Bush

Material: Plastic, int. Ø: 27.2 mm, ext. Ø: 30.5 mm; collar Ø: 49 mm, height: 2/12/14 mm to provide insulation against stray current.

Sealingwasher (27.0/36.0/5.0)



PE-Hard foam LD29, black, to prevent any excess injection mortar HIT-RE on the anchor shaft.

Insert Body (Ø 33 mm)

Material: carbon steel (DIN/ISO 898/1), blue zinc plated: Fe/Zn 10B (DIN 50961), designed for an embedment of 150 mm



HRT-IP Rail Anchor for cast-in/top down construction method

Fastening system	Benefits
 <p data-bbox="699 548 951 580">Hilti HRT-IP (elastic)</p>	<ul style="list-style-type: none"> - for fastening rails to concrete slab track - for top-down (cast-in) construction method - verified for axle loads up to 250 kN - high electrical insulation values concerning stray current - corrosion resistance - with spring (elastic) or spring washer (rigid) - additional accessories available different support stiffness - fixing plate to support assembling - bolt removable - identical system for post-installed/bottom up construction method available (HRT-I) → Rehabilitation - 2 and 4 anchor configuration
 <p data-bbox="699 768 919 799">Hilti HRT-IP (rigid)</p>	

Approvals / certificates

Description	Authority / Laboratory	No. / date of issue
Rail anchor testing	Technical University of Munich	Report no. 2824 / 2011-12-21
		Report no. 2883 / 2012-05-21

Application field covered

Selection of Hilti rail anchors for fastening rails to concrete track slab, based on axle load (A), stiffness (c) and thickness (t) of elastic pad

Anchor *	Elastic pad, t (mm)**	Tramway A = 100 kN	Metro A = 135 kN	Commuter A = 180 kN	Full Size A = 250 kN
HRT- IP M22	15				-
	25				-
HRT - IP M27	10				
	20				
	30				-
Criteria	V_{max}	60 km/h	80 km/h	120 km/h	≥ 250 km/h
	$R_{min}(V_{max})^{***}$	70 m (25 km/h)	200 m (60 km/h)	300 m (80 km/h)	3000 m
	Support spacing	750 mm	750 mm	700 mm	650 mm

* Configuration of base plate (support): -> = Anchors per support

** Stiffness of elastic pad:
 t = 10mm -> c = 20-30 kN/mm
 t = 20mm -> c = 10-20 kN/mm
 t = 30mm -> c = 5-10 kN/mm

*** Indicative value: V_{max} is a function of the existing superelevation (cant) and the lateral acceleration.

Setting details	HRT-IP M22x190/HRT-IP M27x240		
	Anchor	HRT-IP M22	HRT-IP M27
	Embedment depth h_{nom} [mm]	120	150
	Minimum member thickness h_{min} [mm]	-	
	Length of anchor l [mm]	160	200
	Maximum fixing height t_{fix} [mm]	-	-
	Spring deflection S_{inst} [mm]	8	10
	Spring length L_{st} [mm]	35	40
	Wrench size S_{inst} [mm]	38	41

Specification

Hilti HRT-IP (elastic) Rail Anchor		
	<p>Bolt (M22, SW32) Material: 10.9 (DIN 931, EN ISO 4014, hot dipped galvanized) Head: Hexagonal</p>	<p>Bolt (M27, SW41) Material: 8.8 (DIN 931, EN ISO 4014), Blue Zinc Plated: Fe/Zn 10B (DIN 50961) Head: Hexagonal</p>
	<p>Spring (35 mm) Wire Grade: C7 (DIN 2076), yellow zinc plated: Fe/Zn 7C (DIN 50961), Spring rate: 373 N/mm, deformation: 8mm</p>	<p>Spring (40 mm) Wire Grade: C7 (DIN 2076), Yellow Zinc Plated: Fe/Zn 7C (DIN 50961), spring Rate: 300 N/mm, deformation: 10mm → 3.0 kN compression</p>
	<p>Collar Bush Material: Plastic, int. Ø= 27 mm, ext. Ø= 36 mm Volume resistivity: $1.2 \times 10^{12} \Omega \text{ cm}$</p>	<p>Collar Bush Material: Plastic, int. Ø= 28 mm, ext. Ø= 36 mm Volume resistivity: $1.2 \times 10^{12} \Omega \text{ cm}$</p>
	<p>Sealingwasher (22.0/36.0/5.0) To prevent any excess concrete on the anchor shaft</p>	<p>Sealingwasher (27.0/36.0/5.0) To prevent any excess concrete on the anchor shaft</p>
	<p>Fixing plate (26.2/50.0/2.0) To fix the rigid pad (HDPE) and elastic pad to the support assembling during concrete slab pouring.</p>	<p>Fixing plate (31.2/50.0/2.0) To fix the rigid pad (HDPE) and elastic pad to the support assembling during concrete slab pouring.</p>
	<p>Insert Body (Ø 28 mm) Material: carbon steel (DIN/ISO 898/1), blue zinc plated: Fe/Zn 10B (DIN 50961), designed for an embedment of 120 mm</p>	<p>Insert Body (Ø 33 mm) Material: Carbon steel (DIN/ISO 898/1), blue zinc plated: Fe/Zn 10B (DIN 50961), designed for an embedment of 150 mm</p>

Hilti HRT-IP (rigid) Rail Anchor

Bolt (M22, SW32)

Material: 10.9 (DIN 931, EN ISO 4014), hot dipped galvanized
Head: Hexagonal

Spring washer (22.5/35.9/4.0)

Wire Grade: C7 (DIN 2076), blue zinc plated: Fe/Zn 10B (DIN 50961), deformation: 4mm

Washer (23.0/44.0/4.0)

Material: 4.8 (DIN 125), blue zinc plated: Fe/Zn 10B (DIN 50961)
Int. Ø= 23 mm, Ext. Ø= 44 mm

Collar Bush

Material: Plastic, int. Ø: 22.2 mm, ext. Ø: 24.2 mm; collar Ø: 44 mm, height: 2/12/14 mm to provide insulation against stray current.

Sealingwasher (22.0/36.0/5.0)

PE-Hard foam LD29, black, to prevent any excess injection mortar HIT-RE on the anchor shaft.

Fixing plate (26.2/50.0/2.0)

To fix the rigid pad (HDPE) and elastic pad to the support assembling during concrete slab pouring.

Insert Body (Ø 28 mm)

Material: carbon steel (DIN/ISO 898/1), blue zinc plated: Fe/Zn 10B (DIN 50961), designed for an embedment of 120 mm

or

Bolt (M27, SW41)

Material: 8.8 (DIN 931, EN ISO 4014), Blue Zinc Plated: Fe/Zn 10B (DIN 50961)
Head: Hexagonal

Spring washer (27.5/41.5/5.0)

Wire Grade: C7 (DIN 2076), blue zinc plated: Fe/Zn 10B (DIN 50961), deformation: 4mm

Washer (28.0/49.0/4.0)

Material: 4.8 (DIN 125), blue zinc plated: Fe/Zn 10B (DIN 50961)
Int. Ø= 28 mm, Ext. Ø= 49 mm

Collar Bush

Material: Plastic, int. Ø: 27.2 mm, ext. Ø: 30.5 mm; collar Ø: 49 mm, height: 2/12/14 mm to provide insulation against stray current.

Sealingwasher (27.0/36.0/5.0)

PE-Hard foam LD29, black, to prevent any excess injection mortar HIT-RE on the anchor shaft.

Fixing plate (31.2/55.0/2.0)

To fix the rigid pad (HDPE) and elastic pad to the support assembling during concrete slab pouring.

Insert Body (Ø 33 mm)

Material: carbon steel (DIN/ISO 898/1), blue zinc plated: Fe/Zn 10B (DIN 50961), designed for an embedment of 150 mm



Hilti worldwide

Afghanistan

Ansary Engineering Products & Services (AEP), Hilti Division, Kabul
Phone +93 799 481 935

Algeria

BFIX SARL, Algiers
Phone+213 216 013 60
Fax+213 216 055 03

Angola

Agrinsul S.A.R.L., Luanda
Phone+244 222 395 884
Fax+244 222 397 935

Argentina

Hilti Argentina, S.R.L., Buenos Aires
Phone+54 11 4721 4400
Fax+54 11 4721 4410

Aruba

Carfast Holding N.V., Oranjestad
Phone +297-5-828-449
Fax +297-5-832-582

Australia

Hilti (Aust.) Pty. Ltd., Rhodes
Phone+61 2 8748 1000
Fax+61 2 8748 1190

Austria

Hilti Austria Ges.m.b.H., Wien
Phone+43 1 66101
Fax+43 1 66101 257

Azerbaijan

HCA Ltd., Baku
Phone+994 12 598 0955
Fax+994 12 598 0957

Bahrain

Hilti Bahrain W.L.L., Manama
Phone +973 17 702 101
Fax +973 17 702 151

Bangladesh

Aziz & Company Ltd., Hilti Division, Dhaka
Phone+8802 881 4461
Fax+8802 8827028

Barbados

Williams Equipment, Ltd., St.Michel
Phone+1 246 425 5000
Fax+1 246 417 9140

Belgium

Hilti Belgium S.A., Asse (Zellik)
Phone+32 2 4677911
Fax+32 2 4665802

Belize

Benny's Homecenter Ltd., Belize City,
Phone+501 227 2126
Fax+501 227 4340

Benin

La Roche S.A.R.L., Cotonou
Phone+229 21330775
Fax+229 21331920

Bhutan

Hilti Regional Office Middle East & South Asia Region, Dubai
Phone+9714 8060300
Fax+9718 4480485

Bolivia

Genex, S.A., Santa Cruz
Phone+591 3 343 1819
Fax+591 3 343 1819

Bosnia and Herzegovina

Hilti Systems BH d.o.o. Sarajevo, Sarajevo-Ilidža
Phone +387 33 761 100
Fax +387 33 761 101

Botswana

Turbo Agencies, Gaborone
Phone+267 312288
Fax+267 352925

Brazil

Hilti do Brasil Comercial Ltda., Barueri
Phone+55 11 4134 9000
Fax+55 11 4134 9021

Bulgaria

Hilti (Bulgaria) GmbH, Sofia
Phone +359 2976 00 11
Fax +359 2974 01 23

Canada

Hilti (Canada) Ltd., Mississauga, Ontario
Phone 1-800-363-4458
Fax 1-800-363-4459

Cayman Islands

Active Traders Ltd., Georgetown
Phone +345-769-4458
Fax +345-769-5886

Chile

Hilti Chile, Ltda., Santiago
Phone+562 655 3000
Fax+562 365 0505

China

Hilti (China) Ltd., Shanghai
Phone+86 21 6485 3158
Fax+86 21 6485 0311

Colombia

Hilti Colombia, Bogotá
Phone+571 3810121/3810134
Fax+571 3810131

Costa Rica

Superba S.A., La Uruca, San José
Phone+506 255 1044
Fax+506 255 1110

Croatia

Hilti Croatia d.o.o., Sesvete-Zagreb
Phone+385 1 2030 777
Fax+385 1 2030 766

Cyprus

Cyprus Trading Corp. Ltd., Nicosia
Phone+357 22 740340
Fax+357 22 482892

Czech Republik

Hilti CR spol. s r.o., Prag-Pruhonice
Phone+420 2 611 95 611
Fax+420 2 726 80 440

Denmark

Hilti Danmark A/S, Rødovre
Phone +45 88 8000
Fax +45 44 88 8084

Dominican Republik

Dalsan C por A, Santo Domingo
Phone+1 809 565 4431
Fax+1 809 541 7313

Ecuador

Quifatex S.A., Quito
Phone+593 2 247 7400
Fax+593 2 247 8600

Egypt

M.A.P.S.O. for Marine Propulsion & Supply S.A.E., Cairo
Phone +202 2 698 47 77
Fax+202 2 698 82 60

El Salvador

Electrama, S.A. de C.V.,
San Salvador
Phone+503 274 9745
Fax+503 274 9747

Estonia

Hilti Eesti OÜ, Tallinn
Phone+372 6 550 900
Fax+372 6 550 901

Ethiopia

A. Sarafian Industrial
Accessories
& Tools, Addis Ababa
Phone+251 115512408
Fax+251 115519068

Fiji

Central Pacific Agencies,
Suva
Phone+ 679 336 2580

Finland

Hilti (Suomi) OY, Vantaa
Phone+358 9 47870 0
Fax+358 9 47870 100

France

Hilti France S.A.,
Magny-les-Hameaux
Phone+33 1 3012 5000
Fax+331 3012 5012

Gabon

CECA-GADIS, Libreville
Phone+241 740747
Fax+241 720416

Georgia

ICT Georgia Ltd., Tbilisi
Phone+995 32 25 38 42

Germany

Hilti Deutschland GmbH,
Kaufering
Phone+49 8191/90-0
Fax+49 8191/90-1122

Ghana

Auto Parts Limited, Accra
Phone+233 21225924
Fax+233 21224899

Great Britain

Hilti (Gt. Britain) Ltd.,
Manchester
Phone+44 161 886 1000
Fax+44 161 872 1240

Greece

Hilti Hellas SA, Likovrisi
Phone+30210 288 0600
Fax+30210 288 0607

Guatemala

Equipos y Fijaciones, S.A.,
Guatemala City
Phone+502 339 3583
Fax+502 339 3585

Guyana

Agostini's Fastening Systems
Ltd., Port of Spain
Phone +1 868 623 2236
Fax+1 868 624 6751

Honduras

Lazarus & Lazarus, S.A.,
San Pedro Sula
Phone+504 565 8882
Fax+504 565 8624

Hong Kong

Hilti (Hong Kong) Ltd.,
Tsimshatsui, Kowloon
Phone+852 8228 8118
Fax+852 2764 3234 (main)

Hungary

Hilti (Hungária), Budapest
Phone+36 1 4366 300
Fax+36 1 4366 390

Iceland

HAGI ehf HILTI Iceland,
Reykjavik
Phone+354 4143700
Fax+354 4143720

India

Hilti India Pvt Ltd., New Dehli
Phone +91 11 4270 1111
Fax+91 11 2637 1634

Indonesia

P.T. Hilti Nusantara,
Jakarta
Phone+62 21 / 789-0850
Fax+62 21 / 789-0845

Iran

Madavi Company, Hilti Division,
Tehran
Phone+98 21 81 721
Fax+98 21 887 61 523

Iraq

Systems Engineering Services
Co. (SESCO), Hilti Division,
Baghdad
Phone+964 1 778 8933
Phone+964 7901 309592

Ireland

Hilti (Fastening Systems) Ltd.,
Dublin
Phone+353 1 886
Fax+353 1 886 3569

Israel

Hilti (Israel) Ltd., Petach Tikva
Phone+972 3 930 4499
Fax+972 3 930 2095

Italy

Hilti Italia S.p.A., Milano
Phone+3902 212721
Fax+3902 25902189

Jamaica

Evans Safety Ltd., Kingston
Phone+1 876 929 5546
Fax+1 876 926 2069

Japan

Hilti (Japan) Ltd., Yokohama
Phone+81 45 943 6211
Fax+81 45 943 6231

Jordan

Newport Trading Agency, Hilti
Division, Amman
Phone +962 6 4026829
Fax+962 6 4026794

Kazakhstan

EATC Ltd., Almaty
Phone +7327 298 01 80
Fax+7 3272 50 39 57

Korea

Hilti (Korea) Ltd., Seoul,
Phone +82 2 2007 2802
Fax +82 2 2007 2809

Kuwait

Works & Building Co, Hilti
Division, Safat
Phone+965 844 855
Fax+965 4831379

Latvia

Hilti Services Limited, Riga
Phone+371 762 8822
Fax+371 762 8821

Lebanon

Chehab Brothers S.A.L.,
Hilti Division, Beirut
Phone+9611 244435
Fax+9611 243623

Libya

Wemco Workshop &
Maintenance Equipments Co.,
Tripoli
Phone+ 218 21 4801213
Fax+ 218 21 4802810

Liechtenstein

Hilti Aktiengesellschaft, Schaan
Liechtenstein
Phone+423 234 2111
Fax+423 234 2965

Lithuania

UAB Hilti Complete Systems,
Vilnius
Phone+370 6 872 7898
Fax+370 5 271 5341

Luxembourg

Hilti G.D. Luxembourg,
Bertrange
Phone+352 310 705
Fax+352 310 751

Macedonia

Famaki-ve doel, Skopje
Phone+389 2 246 96
Fax+389 2 246 99 97

Madagascar

Société F. Bonnet Et Fils,
Antananarivo
Phone+261 202220326
Fax+261 202222253

Malaysia

Hilti (Malaysia) Sdn. Bhd.,
Petaling Jaya
Phone+60 3 563 38583
Fax+60 3 563 37100

Maldives

Aima Con. Co. Pvt. Ltd,
Hilti Division, Malé
Phone +960 3330909
Fax+960 3313366

Malta

Panta Marketing & Services Ltd.,
Msida
Phone+356 21 441 361
Fax+356 21 440 000

Mauritius

Ireland Blyth Limited, Port Louis
Phone+230 207 05 00
Fax+230 207 04 41

Mexico

Hilti Mexicana, S.A. de C.V.,
Mexico City
Phone+5255 5387-1600
Fax+5255 5281-5967

Moldova

Sculcom Grup SRL, Chisinau
Phone+373 22 212488
Fax+373 22 238196

Mongolia

PSC CO. LTD., Hilti Division,
Ulaan Baatar
Phone+976 +50 88 45 84
Fax+976 50 88 45 85

Morocco

Mafix SA, Casablanca
Phone+2122 257301
Fax+2122 257364

Mozambique

Diatecnica Lda., Maputo
Phone+2581 303816
Fax+2581 303804

Namibia

A. Huester Machinetool
Company (Pty) Ltd., Windhoek
Phone+26461 237083
Fax+26461 227696

Nepal

INCO (P) Ltd., Kathmandu
Phone+9771 4431 992
Fax+9771 4432 728

Netherlands

Hilti Nederland B.V.,
Berkel en Rodenrijs
Phone+3110 5191111
Fax+3110 5191199

Netherlands Antilles

Fabory Carribbean Fasteners
N.V., Davelaar
Phone+599 9 737 6288
Fax+599 9 737 6225

New Zealand

Hilti (New Zealand) Ltd.,
Auckland
Phone +64 9 571 9995
Fax +64 9 571 9942

Nicaragua

Fijaciones de Nicaragua,
Managua
Phone+505 270 4567
Fax+505 278 5331

Nigeria

Top Brands Import Ltd., Hilti
Division
Ikeja
Phone +234 1 817 97 601
Fax+234 1 496 22 00

Norway

Motek AS, Oslo
Phone+47 230 52 500
Fax+47 22 640 063

Oman

Bin Salim Enterprices LLC,
Hilti Division, Muscat
Phone+968 245 63078
Fax+968 245 61193

Pakistan

Hilti Pakistan (Pvt) Ltd
Lahore
Phone +9242 111144584
Fax +9242 37500521

Palestine

Shaer United Co. for Modern
Technology, Beit Jala
Phone+970 2 276 5840
Fax+970 2 274 7355

Panama

Cardoze & Lindo,
Ciudad de Panamá
Phone+507 274 9300
Fax+507 267 1122

Peru

Química Suiza SA, Lima
Phone+511 211 4000
Fax+511 211 4050

Philippines

Hilti (Philippines) Inc., Makati
City
Phone+632 784 7100
Fax+632 784 7101

Poland

Hilti (Poland) Sp. z o.o., Warsaw
Phone +48 320 5500
Fax +48 22 320 5500

Portugal

Hilti (Portugal), Produtos e
Servicos, Lda., Matosinhos –
Senhora Da Hora,
Phone +351 229 568 100
Fax+35122 9568190

Puerto Rico

Hilti Caribe, Inc., Hato Rey,
Phone+1-787 281 6160
Fax+1 787 281 6155

Qatar

Hilti Qatar
Doha
Phone+974 4425022
Fax+974 435 6098

Romania

Hilti Romania S.R.L., Otopeni
Phone+40 213523000

Russia

Hilti Distribution Ltd., Moscow
Phone+7 495 792 52 52
Fax+7 495 792 52 53

République de Djibouti

Les Etablissements TANI,
Djibouti
Phone +235 35 03 37
Fax+235 35 23 33

Saudi Arabia

TFT Ltd
Jeddah
Phone +9662 6983660
Fax +9662 6974696

Senegal

Senegal-Bois, Dakar
Phone+2218 323527
Fax+2218 321189

Serbia Montenegro

Hilti SMN d.o.o., Belgrade
Phone +381-11-2379-515
Fax+381-11-2379-514

Singapore

Hilti Far East Private
Ltd., Singapore
Phone+65 6777 7887,
Fax+65 6777 3057

Slovakia

Hilti Slovakia spol. s r.o.,
Bratislava
Phone+421 248 221 211
Fax+421 248 221 255

Slovenja

Hilti Slovenija d.o.o., Trzin
Phone+386 1 56809 33
Fax+386 1 56371 12

South Africa

Hilti (South Africa) (Pty) Ltd.,
Midrand
Phone+2711 2373000
Fax+2711 2373111

Spain

Hilti Española S.A., Madrid
Phone+3491 3342200
Fax+3491 3580446

Sri Lanka

Hunter & Company Ltd., Hilti
Division
Phone+94 114713352
Fax +94 114723208

St. Lucia

Williams Equipment Ltd,
Castries
Phone +1 758 450-3272
Fax+1 758-450-4206

St. Maarten, N.A.

Carfast Holding N.V., Cole Bay
Phone +599 544 4760
Fax +599-544-4763

Sudan

PEMECO INDUSTRIAL
SUPPLIES CO. LTD. Khartoum
Phone+249 15 517 5031
Fax+249 15 517 5032

Sweden

Hilti Svenska AB, Arlöv
Phone+46 40 539 300
Fax+46 40 435 196

Switzerland

Hilti (Schweiz) AG, Adliswil
Phone+41 844 84 84 85
Fax+41 844 84 84 86

Syria

Al-Safadi Brothers Co., Hilti
Division
Damascus
Phone+96311 6134211
Fax+96311 6123818

Taiwan

Hilti Taiwan Co., Ltd., Taipei
Phone+886 2 2357 9090
Fax+886 2 2397 3730

Tanzania

Coastal Steel Industrial Limited,
Hilti Division, Dar es Salaam
Phone+255 222865662
Fax+255 222865692

Thailand

Hilti (Thailand) Ltd.,
Bangkok Metropolis
Phone+66 2 751 4123
Phone-2-751 4127
Fax+66 2 751 4116

Trinidad and Tobago

Agostini's Fastening Systems
Ltd., TT- Port of Spain
Phone+1 868 623 2236
Fax+1 868 624 6751

Tunisia

Permetal SA, Tunis C.U.N
Phone+216 71 766 911
Fax+216 71 766 807

Turkey

Hilti Insaat Malzemeleri Tic
.A.S.,
Umraniye/Istanbul
Phone+90 216 528 6800
Fax+90 216 528 6898

Turkmenistan

Zemmer Legal, Ashgabat

Uganda

Casements (Africa) Ltd.,
Kampala
Phone+25641 234000
Fax+25641 234301

Ukraine

HILTI (Ukraine) Ltd., Kyiv
Phone +380 44 390 5566
Fax+380 44 390 5565

United Arab Emirates

Hilti Emirates L.L.C.
Phone+9714 8854445
Fax+9714 8854405

USA

Hilti, Inc., Tulsa
Phone (866) 445-8827
Fax 1-800-879-7000

Uruguay

Seler Parrado, S.A., Montevideo
Phone+598 2 902 3515
Fax+598 2 902 0880

Uzbekistan

BNZ Industrial Support,
Tashkent
Phone +998 90 186 2792
Fax +99871 361

Venezuela

Inversiones Hilti de Venezuela,
S.A., Caracas
Phone+58 -212-2034200
Fax+58-212-2034310

Vietnam

Hilti AG Representative Office,
Ho Chi Minh City
Phone+84 8 930 4091
Fax+84 8 930 4090

Yemen

Nasser Ziad Establishment, Hilti
Division, Sana'a
Phone+9671 275238
Fax+9671 272854

Zambia

BML Electrical Limited, Kitwe
Phone+260 (2) 226644

Zimbabwe

Glynn's Bolts (Pvt.) Ltd., Harare
Phone+2634 754042-48
Fax+2634 754049