

HILTI

PR 300-HV2S

Bedienungsanleitung	de
Operating instructions	en
Mode d'emploi	fr
Istruzioni d'uso	it
Manual de instrucciones	es
Manual de instruções	pt
Gebruiksaanwijzing	nl
Brugsanvisning	da
Bruksanvisning	sv
Bruksanvisning	no
Käyttöohje	fi
Használati utasítás	hu
Instrukcja obsługi	pl
Инструкция по эксплуатации	ru
Návod k obsluze	cs
Návod na obsluhu	sk
Kullanma Talimatı	tr
دليل الاستعمال	ar
取扱説明書	ja

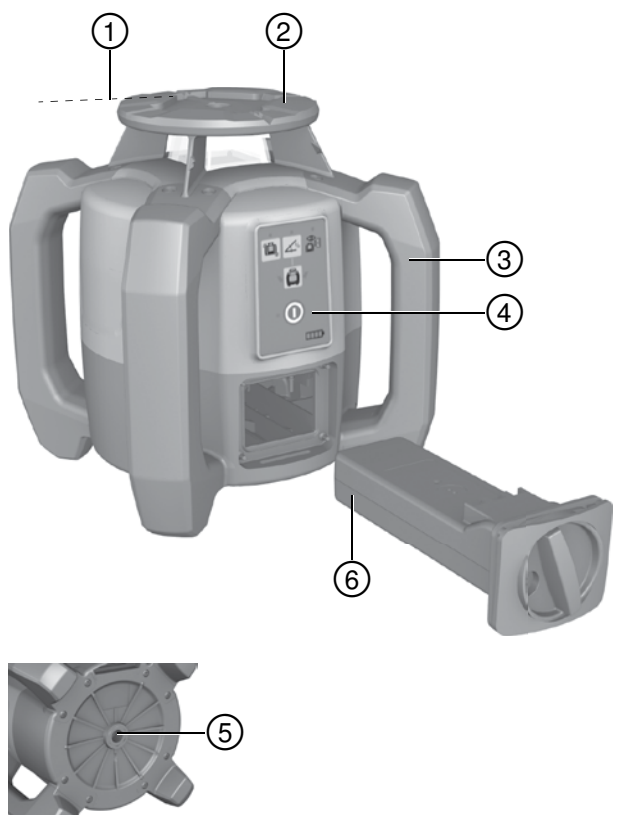



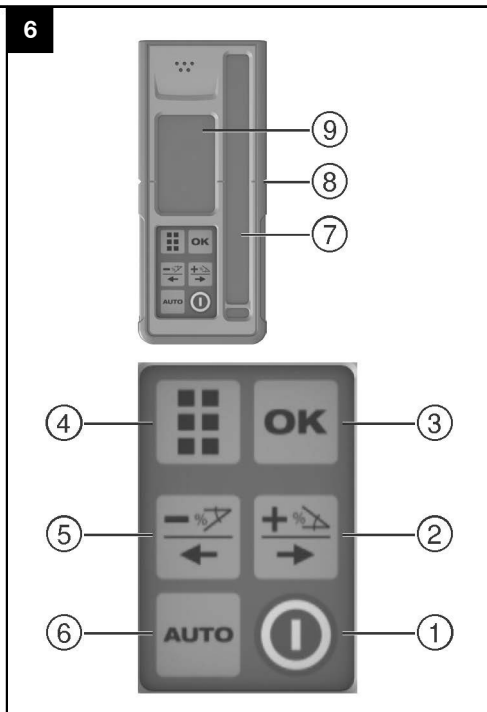
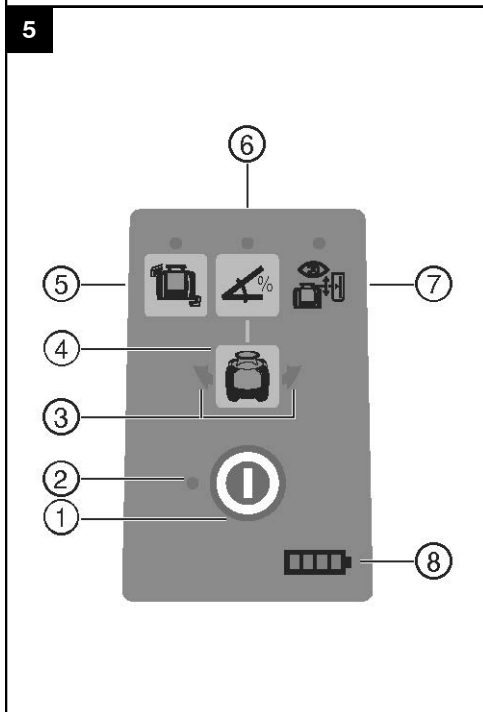
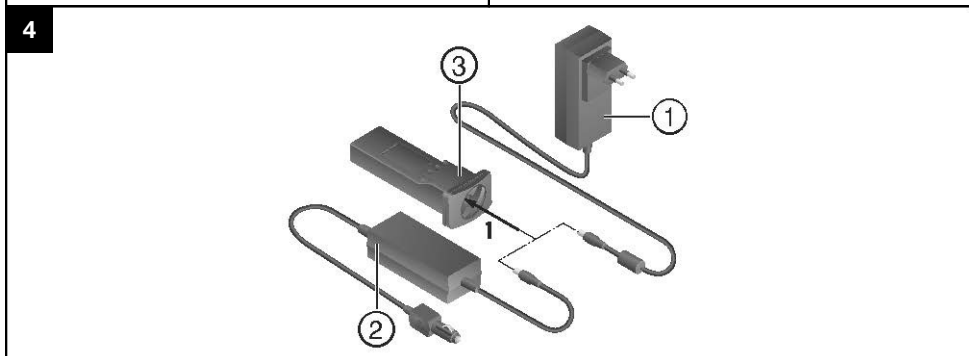
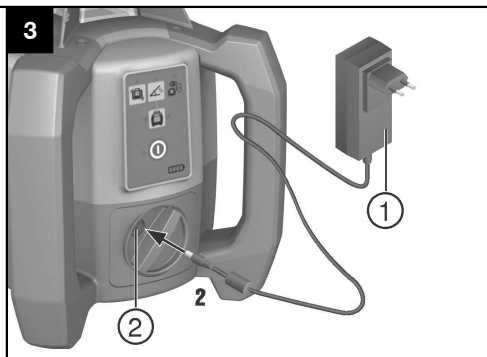
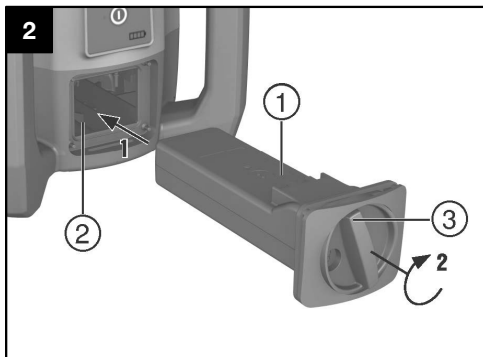

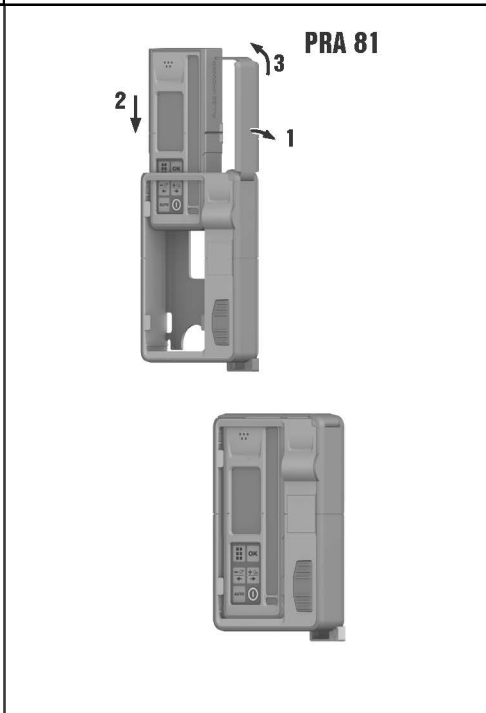
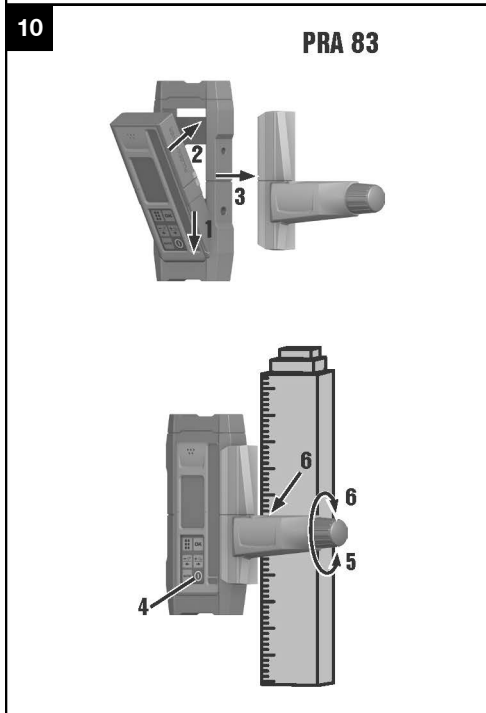
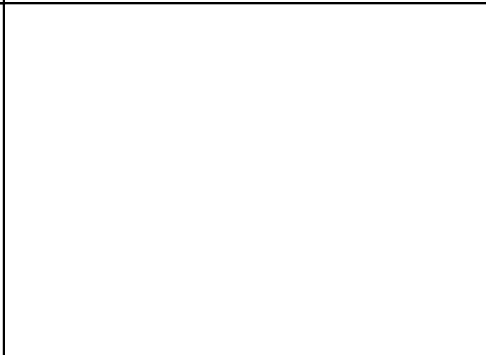
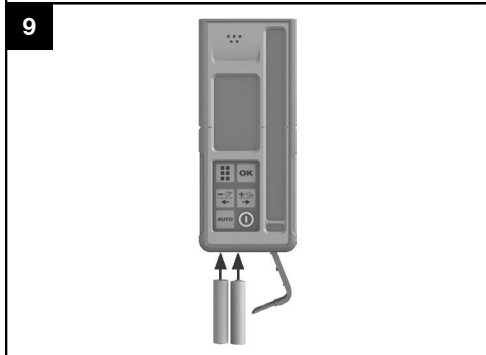
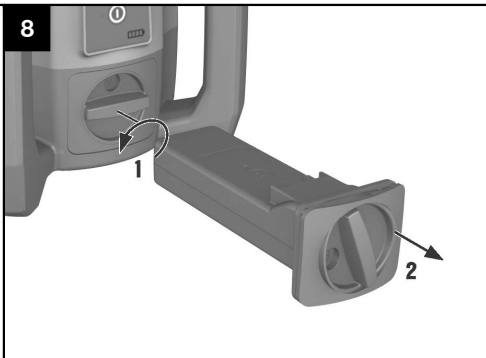
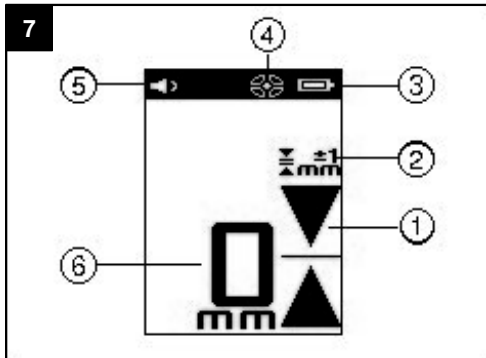

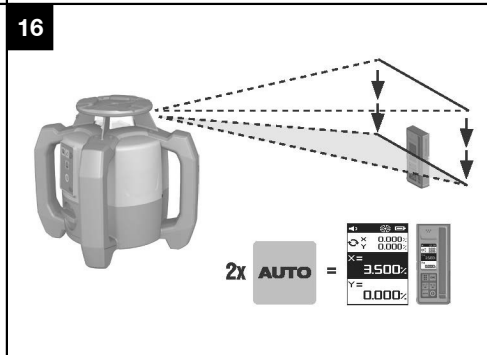
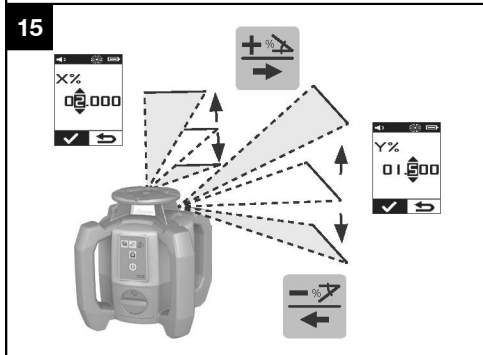
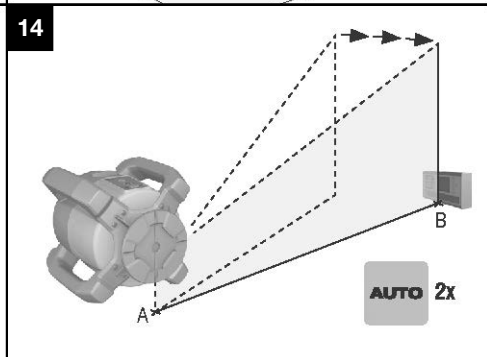
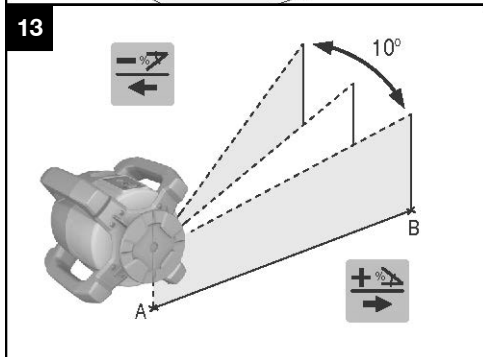
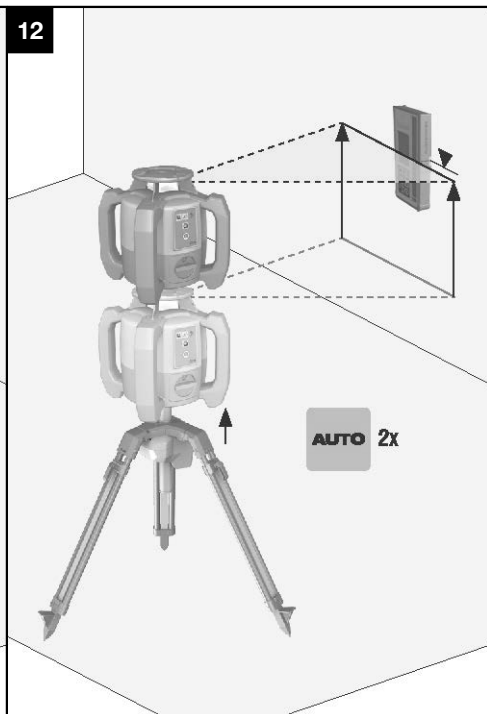
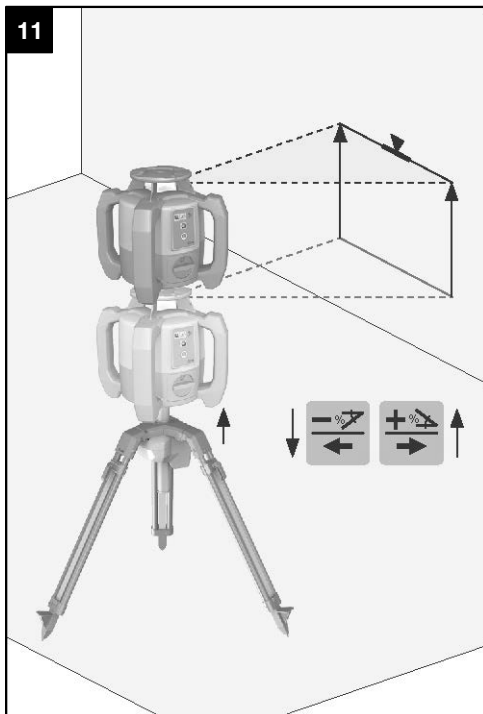

17

X 0.000%
Y 0.000%
X=
-2.000%
Y=
-1.500%

18

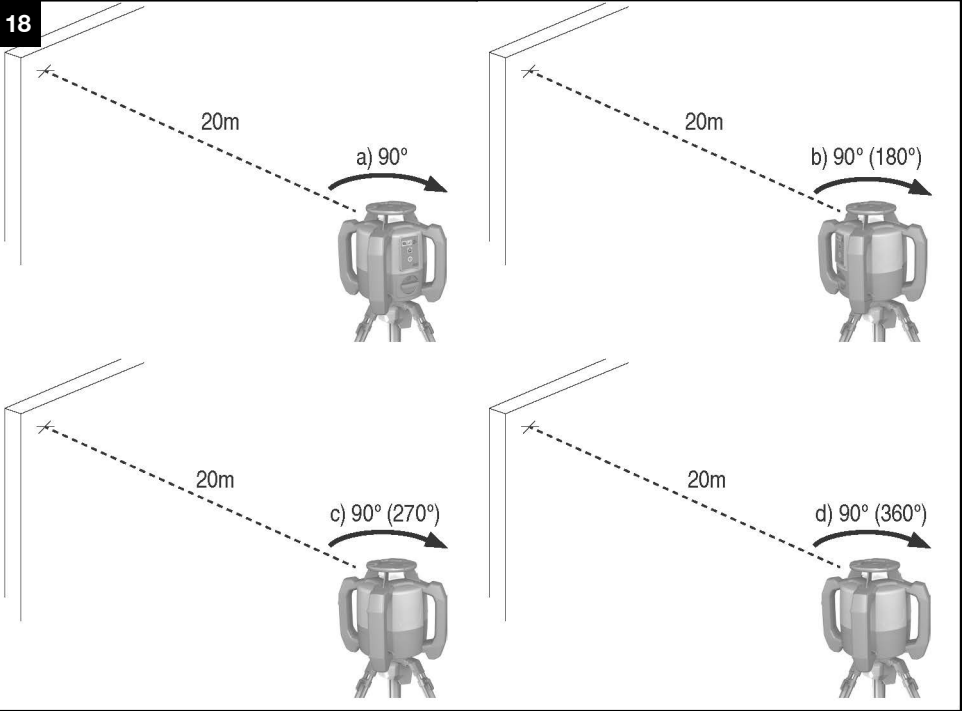

19

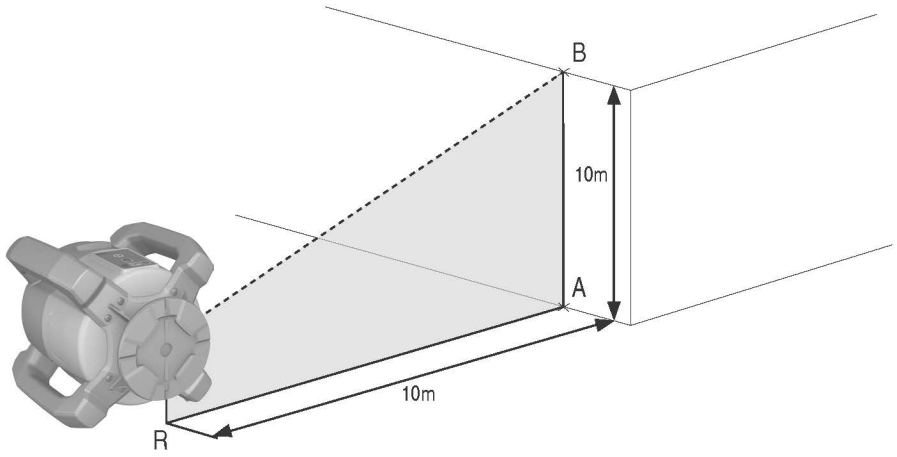

20

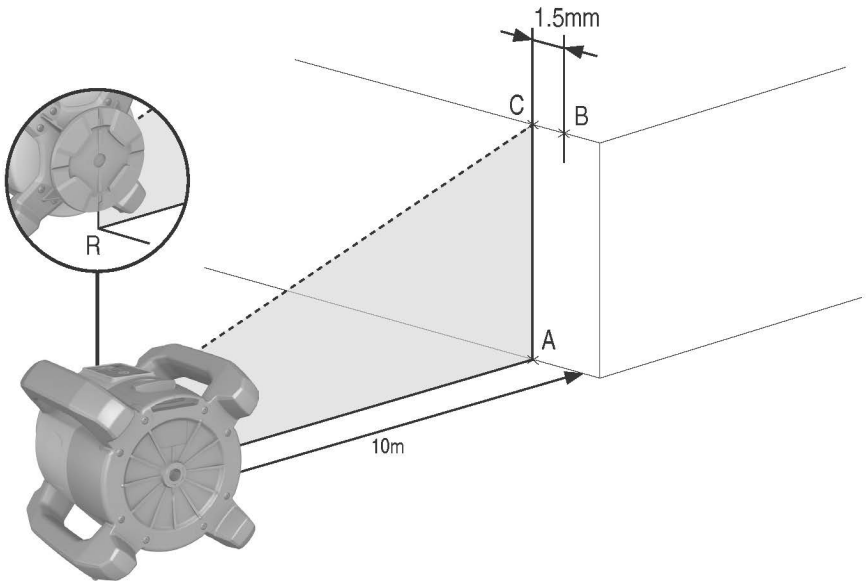

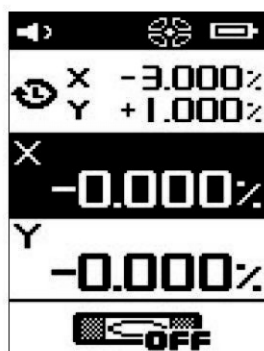

ORIGINAL OPERATING INSTRUCTIONS

PR 300-HV2S rotating laser

It is essential that the operating instructions are read before the tool is operated for the first time.

Always keep these operating instructions together with the tool.

Ensure that the operating instructions are with the tool when it is given to other persons.

Contents	Page
1 General information	26
2 Safety instructions	26
3 Description	28
4 Technical data	31
5 Before use	32
6 Operation	34
7 Care and maintenance	43
8 Troubleshooting	45
9 Disposal	46
10 Manufacturer's warranty - tools	47
11 EC declaration of conformity (original)	47

1 These numbers refer to the illustrations. You can find the illustrations at the beginning of the operating instructions.

In these operating instructions, the designation "the tool" or "the rotating laser" always refers to the PR 300-HV2S. "Remote control", "laser receiver" or "receiver" always refer to the PRA 300.

Rotating laser **1**

- 1 Laser beam (plane of rotation)
- 2 Rotating head
- 3 Pentaprism
- 4 Grip
- 5 Control panel
- 6 Base plate with $\frac{5}{8}$ " thread
- 7 PRA 84 Li-Ion battery

Battery compartment **2**

- 1 PRA 84 Li-Ion battery
- 2 Battery compartment
- 3 Catch

Charging the battery in the tool **3**

- 1 PUA 81 AC adapter
- 2 Charging socket

Charging the battery externally (not in the tool) **4**

- 1 PUA 81 AC adapter
- 2 PUA 82 motor vehicle power adapter
- 3 Charging activity LED

Rotating laser control panel **5**

- 1 On/off button
- 2 Auto-leveling LED
- 3 LED arrow for electronic inclination alignment
- 4 Manual electronic inclination alignment key (only in conjunction with inclined plane mode)
- 5 Shock warning function key and LED
- 6 Inclined plane mode key and LED
- 7 Surveillance mode LED (only with automatic vertical alignment)
- 8 Battery charge status LED

PRA 300 laser receiver / remote control unit control panel **6**

- 1 On/off button
- 2 Inclination entry key (Plus / Right or Up arrow key) (with the PRA 90)
- 3 Confirmation button (OK)
- 4 "Menu" button
- 5 Inclination entry key (Minus / Left or Down arrow key) (with the PRA 90:
- 6 Automatic alignment / surveillance mode key (vertical) (double click)
- 7 Receiving window
- 8 Marking notch
- 9 Display

Display on the PRA 300 laser receiver / remote control unit **7**

- 1 Indicator showing position of receiver relative to height of laser plane
- 2 Indication of accuracy
- 3 Battery status
- 4 Virtual beam shields on/off
- 5 Volume
- 6 Indication of distance from laser plane

en

1 General information

1.1 Safety notices and their meaning

DANGER

Draws attention to imminent danger that will lead to serious bodily injury or fatality.

WARNING

Draws attention to a potentially dangerous situation that could lead to serious personal injury or fatality.

CAUTION

Draws attention to a potentially dangerous situation that could lead to slight personal injury or damage to the equipment or other property.

NOTE

Draws attention to an instruction or other useful information.

1.2 Explanation of the pictograms and other information

Symbols



Read the operating instructions before use.



General warning



Warning: caustic substances



Warning: electricity



For indoor use only



Return materials for recycling



Do not look into the beam.



Warning: explosive substances



Locked



Unlocked

On the tool



**LASER RADIATION
DO NOT STARE INTO BEAM
CLASS 2 LASER PRODUCT**

Wavelength: 620-690nm
Maximum output power: $P_o < 4.85\text{mW}$, $\geq 300\text{rpm}$
This product complies with IEC 60825-1: 2007 and 21 CFR 1040.10 and 1040.11
Except for deviations pursuant for Laser Notice No.50, date June 24, 2007.

Laser Class 2 product. Do not stare into the beam.

Location of identification data on the tool

The type designation and serial number can be found on the type identification plate on the tool. Make a note of this data in your operating instructions and always refer to it when making an enquiry to your Hilti representative or service department.

Type: _____

Generation: 01 _____

Serial no.: _____

2 Safety instructions

2.1 Basic information concerning safety

In addition to the information relevant to safety given in each of the sections of these operating instructions, the following points must be strictly observed at all times.

2.2 General safety rules

- Do not render safety devices ineffective and do not remove information and warning notices.
- Modification of the tool is not permissible.

- Stay alert, watch what you are doing and use common sense when operating the tool. Don't use the tool when you are tired or under the influence of drugs, alcohol or medication. A moment of inattention while operating tools may result in serious personal injury.
- Keep laser tools out of reach of children.
- Failure to follow the correct procedures when opening the tool may cause emission of laser radiation in excess of class 2 or, respectively, class 3. Have the tool repaired only at a Hilti service center.

- f) **Do not operate the tool in explosive atmospheres, such as in the presence of flammable liquids, gases or dust.** Tools and appliances create sparks which may ignite the dust or fumes.
- g) (Statement in accordance with FCC §15.21): Changes or modifications not expressly approved by the manufacturer can void the user's authority to operate the equipment.
- h) Use of setting-up / adjusting devices and equipment or operating procedures other than those specified in these instructions may lead to exposure to hazardous radiation.
- i) **Check the condition of the tool before use. If the tool is found to be damaged, have it repaired at a Hilti service center.**
- j) **Maintain the tool carefully. Check for misalignment or binding of moving parts, breakage of parts and any other condition that may affect the tool's operation. If damaged, have the tool repaired before use.** Poor maintenance is the cause of many accidents.
- k) **The user must check the accuracy of the tool after it has been dropped or subjected to other mechanical stresses.**
- l) **Check the tool before using it for important measuring work.**
- m) **Check the accuracy of the measurements several times during use of the tool.**
- n) **When the tool is brought into a warm environment from very cold conditions, or vice-versa, allow it to become acclimatized before use.**
- o) **If mounting on an adapter, check that the tool is screwed on securely.**
- p) **Keep the laser exit aperture clean to avoid measurement errors.**
- q) **Although the tool is designed for the tough conditions of jobsite use, as with other optical and electronic instruments (e.g. binoculars, spectacles, cameras) it should be treated with care.**
- r) **Although the tool is protected to prevent entry of dampness, it should be wiped dry each time before being put away in its transport container.**
- s) **Keep the electrical contacts dry (protect from rain or dampness).**
- t) **Use the AC adapter only for connecting to the AC supply.**
- u) **Check to ensure that the tool and AC adapter do not present an obstacle that could lead to a risk of tripping and personal injury.**
- v) **Ensure that the workplace is well lit.**
- w) **Check the condition of the extension cord and replace it if damage is found. Do not touch the AC adapter if the extension cord or AC adapter are damaged while working. Disconnect the supply cord plug from the power outlet. Damaged supply cords or extension cords present a risk of electric shock.**
- x) **Avoid body contact with earthed or grounded surfaces, such as pipes, radiators, ranges and refrigerators.** There is an increased risk of electric shock if your body is earthed or grounded.

- y) **Do not expose the supply cord to heat, oil or sharp edges.**
- z) **Never operate the AC adapter when it is dirty or wet. Dust (especially dust from conductive materials) or dampness adhering to the surface of the AC adapter may, under unfavorable conditions, lead to electric shock. Dirty or dusty tools should thus be checked at a Hilti Service Center at regular intervals, especially if used frequently for working on conductive materials.**
- z) **Avoid touching the contacts.**

2.2.1 Battery tool use and care

- a) **Do not expose batteries to high temperatures and keep them away from fire.** This presents a risk of explosion.
- b) **Do not disassemble, squash or incinerate batteries and do not subject them to temperatures over 75°C.** This presents a risk of fire, explosion or injury through contact with caustic substances.
- c) **Avoid ingress of moisture.** Moisture in the interior of the tool may cause a short circuit and chemical reactions resulting in burns to the skin or fire.
- d) Under abusive conditions, liquid may leak from the battery. **Avoid contact. If contact accidentally occurs, flush with water. In the event of the liquid coming into contact with the eyes, rinse the eyes with plenty of water and consult a doctor.** Liquid ejected from the battery may cause irritation or burns.
- e) **Use only batteries of the type approved for use with the applicable tool.** Use of other batteries or use of the batteries for purposes for which they are not intended presents a risk of fire and explosion.
- f) **Observe the special guidelines applicable to the transport, storage and use of Li-ion batteries.**
- g) **When not in use, keep the battery and the charger away from paper clips, coins, keys, nails, screws or other small metal objects that could cause a short circuit at the battery terminals or the charging contacts.** A short circuit at the battery terminals or charging contacts could result in personal injury (burns) or fire.
- h) **Avoid short circuiting the battery terminals.** Check that the battery terminals and the terminals in the device are free from foreign objects before inserting the battery in the device. Short circuiting the battery terminals presents a risk of fire, explosion and chemical burns.
- i) **Do not charge or continue to use damaged batteries (e.g. batteries with cracks, broken parts, bent or pushed-in and/or pulled-out contacts).**
- j) **Use only the PUA 81 AC adapter, PUA 82 motor vehicle power adapter or other chargers recommended by the manufacturer to power the tool or charge the battery.** Failure to observe these points may result in damage to the tool. A charger that is suitable for a certain type of battery may present a risk of fire when used with other types of battery.

2.3 Proper organization of the work area

- a) **Secure the area in which you are working and take care to avoid directing the beam towards other persons or towards yourself when setting up the tool.**
- b) **Avoid unfavorable body positions when working from ladders. Make sure you work from a safe stance and stay in balance at all times.**
- c) Readings taken in the vicinity of reflective objects or surfaces, through panes of glass or similar materials may produce incorrect results.
- d) **Ensure that the tool is set up on a steady, level surface (not subject to vibration).**
- e) **Use the tool only within its specified limits.**
- f) Make sure that your PR 300-HV2S is responding only to your PRA 300 and not to any other PRA 300 that may be in use on the jobsite.
- g) **When working in “charging during operation” mode, attach the AC adapter in a secure position, e.g. on a tripod.**
- h) Use of products for applications different from those intended could result in hazardous situations. **Use the product and its accessories etc. in accordance with these instructions and in the manner intended for the particular type of product. Take**

the working conditions and the work to be performed into account.

- i) **Use of the telescopic staff in the vicinity of overhead high voltage cables is not permissible.**

2.3.1 Electromagnetic compatibility

Although the tool complies with the strict requirements of the applicable directives, Hilti cannot entirely rule out the possibility of the tool being subject to interference caused by powerful electromagnetic radiation, leading to incorrect operation. Check the accuracy of the tool by taking measurements by other means when working under such conditions or if you are unsure. Likewise, Hilti cannot rule out the possibility of interference with other devices (e.g. aircraft navigation equipment).

2.3.2 Laser classification for Laser Class 2 products

According to the version purchased, the tool complies with Laser Class 2 as per IEC60825-1:2007 / EN60825-1:2007. This tool may be used without need for further protective measures. Nevertheless, as with the sun, one should not look directly into sources of bright light. In the event of direct eye contact with the laser beam, close your eyes and move your head out of the path of the laser beam. Do not direct the laser beam toward persons.

3 Description

3.1 Use of the product as directed

The Hilti PR 300-HV2S is a rotating laser tool with a visible rotating laser beam and a reference beam set at 90° to the main beam. The rotating laser can be used vertically, horizontally and for inclinations in one or two planes.

The tool is designed to be used to determine, transfer and check levels, verticals, slopes and right angles. Examples of its uses are: transferring datums and height marks, determining right angles for walls, vertical alignment on reference points and setting out slopes.

The tool is designed for professional use and may be operated, serviced and maintained only by trained, authorized personnel. This personnel must be informed of any special hazards that may be encountered. The tool and its ancillary equipment may present hazards when used incorrectly by untrained personnel or when used not as directed.

Hilti supplies various accessories which allow the tool to be used with maximum efficiency.

To avoid the risk of injury, use only genuine Hilti accessories and insert tools.

3.2 Features

The tool makes it possible for a single person to level or align in any plane quickly and with great accuracy.

Leveling takes place automatically after the tool is switched on. The laser beam is activated after the tool has leveled itself.

LEDs indicate the current operating status.

The tool is powered by a rechargeable Li-ion battery which can be charged while the tool is in operation.

3.3 Combined use of the PRA 300 remote control / laser receiver

The PRA 300 is a combined remote control unit and laser receiver. It can be used to control the PR 300-HV2S rotating laser over great distances. The PRA 300 also serves as a laser receiver and can thus be used to detect and indicate the laser beam at great distance.

3.4 Digital distance measurement display

The laser receiver displays digitally the distance between the laser plane and the marking notch. This allows the user to determine the exact position of the receiver relative to the laser plane, with millimeter accuracy, in a single operation.

3.5 Automatic alignment and surveillance

Using the PR 300-HV2S and the PRA 300, a single person can align the laser plane automatically with a certain point with great accuracy. The tool detects the applicable alignment (horizontal, vertical or inclined) automatically and uses the automatic alignment function accordingly (horizontal with the PRA 90 plus inclination) or automatic alignment with subsequent monitoring of the plane (vertical). With the aid of the PRA 300, the surveillance function checks alignment of the laser plane at regular intervals in order to avoid possible deviations due to temperature fluctuations, wind or similar. The surveillance function can be deactivated.

3.6 Digital inclination display with patented automatic electronic inclination alignment

The digital inclination display is capable of indicating an inclination of up to 25% when the PR 300-HV2S is operating in inclined mode. This makes it possible to set out and check slopes without having to make any calculations. Automatic electronic inclination alignment allows optimum inclination accuracy.

3.7 Shock warning

The shock warning function is activated two minutes after the tool has leveled itself after switching on. If a key is pressed within these two minutes, the two-minute delay begins again. The tool switches to warning mode if it is brought out of level while in operation (due to vibration or an impact); all LEDs begin to blink and the laser switches off (the head stops rotating).

3.8 Automatic cut-out

The laser does not switch on and all LEDs blink if the tool is set up outside its self-leveling range ($\pm 16^\circ$ X-axis, $\pm 10^\circ$ Y-axis) or if movement is blocked mechanically.

The tool can be set up on a tripod with a 5/8" thread or stood directly on some other steady surface (free of vibration). When automatic leveling is activated for one or both axes, the built-in servo system ensures that the specified accuracy is maintained. The tool switches itself off when automatic leveling cannot be achieved (tool set up outside its leveling range or physical impediment of the mechanism) or when knocked off level (see "Shock warning" section).

NOTE

If the correct level cannot be achieved, the laser switches itself off and all LEDs blink.

3.9 Items supplied

- 1 PR 300-HV2S rotating laser
- 1 PRA 300 laser receiver / remote control unit
- 1 PRA 83 laser receiver holder
- 2 Operating instructions
- 1 PRA 84 Li-Ion battery
- 1 PUA 81 AC adapter
- 2 Batteries (size AA cells)
- 2 Manufacturer's certificates
- 1 Hilti toolbox

NOTE

Accessories are available from your Hilti Center or can be ordered online at www.hilti.com.

3.10 Operating status indicators

The tool is equipped with the following operating status indicators: Auto-leveling LED, battery charge status LED, shock warning function deactivation LED, inclined plane mode LED, surveillance mode LED and electronic inclination alignment LED.

3.11 LED indicators on the PR 300-HV2S rotating laser

Auto-leveling LED	The green LED blinks.	The tool is in the leveling phase.
	The green LED lights constantly.	The tool has leveled itself / is operating normally.
Shock warning deactivation LED	The orange LED lights constantly.	The shock warning function is deactivated.
Inclined plane mode LED	The orange LED blinks.	Alignment in the sloping plane.
	The orange LED lights constantly.	Inclined plane mode is active.
Surveillance mode LED	The orange LED lights constantly.	The tool is aligning the laser plane with the reference point (PRA 300).
	The orange LED blinks.	The tool is in surveillance mode. Alignment with the reference point (PRA 300) is correct.
Electronic inclination alignment LED	The orange LED arrows blink.	The tool is in electronic inclination alignment mode, the PRA 300 receives no laser beam.
	Both orange LED arrows light constantly.	The tool is correctly aligned with the PRA 300.
	The orange LED arrow on the left lights.	The tool must be rotated in a clockwise direction.
	The orange LED arrow on the right lights.	The tool must be rotated in a counter-clockwise direction.
All LEDs	All LEDs blink.	The tool has been bumped or is indicating a fault.

3.12 Charge state of the Li-ion battery while the tool is in operation

LEDs light constantly	LEDs blink	Charge status C
LED 1, 2, 3, 4	-	$C \geq 75 \%$
LED 1, 2, 3	-	$50 \% \leq C < 75 \%$
LED 1, 2	-	$25 \% \leq C < 50 \%$
LED 1	-	$10 \% \leq C < 25 \%$
-	LED 1	$C < 10 \%$

3.13 Charge state of the Li-ion battery while charging in the tool

LEDs light constantly	LEDs blink	Charge status C
LED 1, 2, 3, 4	-	$C = 100 \%$
LED 1, 2, 3	LED 4	$75 \% \leq C < 100 \%$
LED 1, 2	LED 3	$50 \% \leq C < 75 \%$
LED 1	LED 2	$25 \% \leq C < 50 \%$
-	LED 1	$C < 25 \%$

3.14 Charging activity display on the Li-ion battery while charging the battery outside the tool

If the red LED lights constantly, the battery is being charged.

If the red charging activity LED does not light, then either the charging operation is complete or the charger is providing no current.

4 Technical data

Right of technical changes reserved.

PR 300-HV2S

Receiving range (diameter)	Typical distance with PRA 300: 2...600 m
Range of remote control (circle diameter)	Typical distance with PRA 300, In the open field, without external influences: 0...240 m
Accuracy ¹	at 10 m: ± 0.5 mm
Plumb beam	Continuous, perpendicular to the plane of rotation
Laser class	Class 2, 620-690 nm; < 1 mW (EN 60825-1:2007 / IEC 60825-1:2007); Maximum power < 4.85 mW at ≥ 300 r.p.m.
Speed of rotation	600/min, 1,000/min (during the automatic alignment procedure)
Inclination range	With the tool already inclined: $\leq 25\%$
Self-leveling range	$\pm 16^\circ$ X-axis, $\pm 10^\circ$ Y-axis
Power source	7.2V/ 4.5 Ah Li-ion battery
Battery life	Temperature +25°C, Li-ion battery: ≥ 25 h
Operating temperature range	-20... +50°C
Storage temperature range (dry)	-25... +60°C
Protection class	IP 66 (in accordance with IEC 60529); Not in "charging during operation" mode
Tripod thread	$\frac{5}{8}$ " x 18
Weight (incl. PRA 84)	2.5 kg
Drop test height ²	1.5 m

¹ Influences such as particularly high temperature fluctuations, dampness, shock, dropping, etc. can affect accuracy. Unless stated otherwise, the tool was adjusted or calibrated under standard ambient conditions (MIL-STD-810G).

² The drop test was carried out from a tripod, dropping onto flat concrete under standard ambient conditions (MIL-STD-810G).

PRA 300

Detection range (area diameter)	With the PR 300-HV2S (typical): 2...600 m
Signal tone generator	3 volume levels plus mute setting
Liquid-crystal display	On both sides
Indicator range, distance from zero	± 52 mm
Laser plane display range	± 1 mm
Length of the detection area	120 mm
Casing top edge center indicator	75 mm
Marking notches	On both sides
Time without detection before automatic power off	15 min
Weight (including batteries)	0.25 kg
Power source	2 AA batteries
Battery life	Temperature +20°C: Approx. 40 h (depending on the quality of the alkaline batteries used)
Operating temperature range	-20... +50°C
Storage temperature range	-25... +60°C

¹ The drop test was carried out using the PRA 83 receiver holder, dropped onto flat concrete under standard ambient conditions (MIL-STD-810G).

en

Protection class	IP 66 (in accordance with IEC 60529), except battery compartment
Drop test height ¹	2 m
¹ The drop test was carried out using the PRA 83 receiver holder, dropped onto flat concrete under standard ambient conditions (MIL-STD-810G).	

en

PRA 84 Li-Ion battery

Rated voltage (normal mode)	7.2 V
Maximum voltage (during operation or during charging while in operation)	13 V
Rated current	180 mA
Charging time	Temperature +32°C: 2 h 10 min (battery 80 % charged)
Operating temperature range	-20...+50°C
Storage temperature range (dry)	-25...+60°C
Charging temperature range (also for charging during operation)	+0...+40°C
Weight	0.3 kg

PUA 81 AC adapter

AC supply	115...230 V
AC frequency	47...63 Hz
Rated power	36 W
Rated voltage	12 V
Operating temperature range	+0...+40°C
Storage temperature range (dry)	-25...+60°C
Weight	0.23 kg

5 Before use

NOTE

The tool may be powered only by a Hilti PRA 84 or PRA 84G battery.

5.1 Inserting the battery

- Slide the battery into the tool.
- Turn the catch in a clockwise direction until the “locked” symbol appears.

5.2 Removing the battery

- Turn the catch in a counter-clockwise direction until the “unlocked” symbol appears.
- Remove the battery from the tool.

5.3 Charging the battery

5.3.1 Charging a battery for the first time

Charge the battery fully before using it for the first time.

NOTE

Make sure the system to be charged is standing securely.

5.3.2 Recharging a battery

- Check that the outer surfaces of the battery are clean and dry.
- Insert the battery in the tool.

NOTE Li-ion batteries are ready for use at any time, even when only partly charged.

Charging progress is indicated by the LEDs when the tool is switched on.

5.4 Options for charging the battery

NOTE

Make sure that the recommended temperature range is observed when charging (0 to 40°C).

DANGER

The PUA 81 AC adapter is for indoor use only. Avoid ingress of moisture.

5.4.1 Charging the battery in the tool 4

1. Insert the battery in the battery compartment (see 5.1).
2. Rotate the socket cover until the charging socket on the battery becomes visible.
3. Plug the cord from the AC adapter or motor vehicle power adapter into the battery.
The battery will be charged.
4. Switch the tool on in order to display the charging status while charging is in progress.

5.4.2 Charging the battery when not in the tool 5

1. Remove the battery (see 5.2).
2. Connect the cord from the AC adapter or the motor vehicle power adapter to the battery.
The red LED on the battery indicates charging activity.

5.4.3 Charging the battery while the tool is in operation

DANGER

Operation in “charging during operation” mode is not permissible for outdoor use or in damp surroundings.

1. Rotate the socket cover until the charging socket on the battery becomes visible.
2. Plug the cord from the AC adapter into the battery.
The tool continues to operate while charging and battery charging status is indicated by the LEDs on the tool.

5.5 Switching on the rotating laser

Press the on/off button .

NOTE

After switching on, the tool begins to level itself automatically. After completion of the leveling process, the laser beam is switched on and begins to rotate in the normal direction.

5.6 LED indicators

See section “LED indicators on the PR 300-HV2S rotating laser” for a description.

5.7 Inserting batteries in the PRA 300 9

DANGER

Do not use damaged batteries.

DANGER

Do not mix old and new batteries. Do not mix batteries of different makes or types.

NOTE

The PRA 300 may be powered only by batteries manufactured in accordance with the applicable international standards.



1. Open the laser receiver battery compartment.
2. Insert the batteries in the laser receiver.
NOTE Check to ensure correct polarity when inserting the batteries.
3. Close the battery compartment cover.

5.8 Pairing

The rotating laser and the remote control / laser receiver are already paired when supplied. Additional laser receivers of the same type or PRA 90 automatic tripods are not ready for use until they have been paired. The rotating laser and these accessories must be paired before they can be used together. Pairing tools and devices means that they are explicitly assigned to each other. The rotating laser and the PRA 90 automatic tripod then receive only signals from the remote control units / laser receivers with which they have been paired. Pairing allows devices to be used close to other rotating lasers without the risk that their settings will be altered by these other lasers.



5.8.1 Pairing the rotating laser and the laser receiver



1. Press the on/off buttons  on the rotating laser and laser receiver simultaneously and keep them pressed for at least 3 seconds.
Successful pairing is indicated by a signal tone emitted by the laser receiver and all LEDs blinking on the rotating laser. At the same time, the symbol shown above  appears briefly in the laser receiver display. The rotating laser and the receiver switch off automatically after pairing.
2. Switch the paired devices on again.

5.8.2 Pairing the PRA 90 tripod and the receiver











1. Press the on/off buttons  on the PRA 90 automatic tripod and laser receiver simultaneously and keep them pressed for at least 3 seconds.
Successful pairing is indicated by a signal tone emitted by the laser receiver and all LEDs blinking on the rotating laser. At the same time, the symbol shown above  appears briefly in the laser receiver display. The rotating laser and the receiver switch off automatically after pairing.
2. Switch the paired devices on again.
The rotating laser with the tripod  is shown in the display on the laser receiver.

6 Operation

6.1 Overview of general symbols

Overview of general symbols

General symbols

	Activity successfully completed.
	Information
	Warning
	Shock warning is activated
	Sleep mode is activated
	The rotating laser is in sleep mode
	Inclined plane mode is activated
	Automatic electronic alignment is activated
	Manual alignment

6.2 Checking the tool

Check the accuracy of the tool before using it for important tasks, especially if it has been dropped or subjected to unusual influences or impacts etc. (see 7.6).

6.3 Switching the tool on

Press the on/off button .

NOTE

After switching on, the tool begins to level itself automatically.

6.4 Working with the PRA 300 laser receiver / remote control unit

The PRA 300 is a combined laser receiver and remote control unit. The remote control makes working with the rotating laser more convenient and is required in order to make use of certain functions. The laser beam is indicated by visual and audible signals.

6.4.1 Using the PRA 300 laser receiver as a hand-held tool

1. Press the on/off button .
- NOTE** If the receiver was switched on before the PR 300 rotating laser was started, a laser beam will not yet be shown in the receiver's display.
2. Hold the laser receiver with the detection area directly in the plane of the rotating laser beam.





6.4.2 Working with the laser receiver in the PRA 83 receiver holder







1. Push the receiver into the rubber sleeve of the PRA 83 at an angle until it fully encloses the receiver. Take care to ensure that the detection area and the keys are facing the front.
2. Fit the receiver, complete with the rubber sleeve, onto the grip section. The cover and grip section are joined together by the magnetic holder.
3. Switch the receiver on by pressing the on/off button .
4. Turn the rotating grip to the open position.
5. Secure the PRA 83 receiver holder on the telescopic staff or leveling staff by tightening the clamping knob.
6. Hold the laser receiver with the detection area directly in the plane of the rotating laser beam.



6.4.3 Working with the PRA 81 height transfer device

1. Open the catch on the PRA 81.
2. Insert the laser receiver in the PRA 81 height transfer device.
3. Close the catch on the PRA 81.
4. Switch the laser receiver on by pressing the on/off button .
5. Hold the laser receiver with the detection area directly in the plane of the rotating laser beam.
6. Position the laser receiver so that the distance display shows "0".
7. Use the measuring tape to measure the desired distance.

6.5 Menu options on the PRA 300 laser receiver / remote control unit

1. The "Menu" key  may be pressed at any time during operation. The menu then appears in the display.
2. Use the arrow keys  or , as required, to select the individual items from the menu. **NOTE** The arrow keys  or  let you select the various settings. Press the **OK** key to save the settings you have selected.



	Volume level
 	Units
	System setup
	Tool setting
	Information
	Back

3. You can leave the menu again at any time by pressing the "Menu" key  or the "Back" key .

6.5.1 Setting the volume level

The laser receiver is set to "Normal" volume every time it is switched on. The volume can be adjusted by way of the "Volume" function in the menu. One of four settings can be selected: "Low", "Normal", "High" or "Off". After making a selection you are returned automatically to the normal operating mode.

	Volume high
------------------------------------------------------------------------------------	-------------









	Volume normal
	Volume low
	Volume off

Press the “Back” key  if you wish to return to the menu.



6.5.2 Setting the units

Using the units function from the menu you can set the desired accuracy of the digital display in millimeters or inches. After making each selection you are returned automatically to the normal operating mode or, alternatively, pressing the “Back” key  will take you back to the menu.

Units









	1 mm		1/16"
	2 mm		1/8"
	5 mm		1/4"
	10 mm		1/2"
	25 mm		1"

6.5.3 System setup

The following items appear in the menu: “Activate / deactivate beam shields”  and “Sleep mode” .

6.5.3.1 Activating/deactivating the beam shields





The laser beam from the PR 300-HV2S can be shut off at one or more sides of the tool. This feature is useful when you are using several laser tools simultaneously on the jobsite and it is necessary to prevent reception of the beam from more than one laser tool. The laser plane is divided into four quadrants. These are marked on the casing of the tool and can be set as follows:

1. In the menu , select the system settings  and confirm your selection by pressing the **OK** key.
 2. Select the “Activate / deactivate beam shields” function  and confirm your selection by pressing the **OK** key.
 3. Use the arrow keys   to navigate to the correct quadrant.
 4. Activate / deactivate the desired quadrants by pressing the OK key **OK**.
 5. Confirm this setting by pressing the OK key .
- If the quadrant is visible its status is “On”. If the quadrant is not visible its status is “Off”.
6. Press the “Back” key  to return to the “System setup” menu item  or press the “Menu” key  to return to normal operating mode.











NOTE Settings that affect the rotating laser only become effective when the rotating laser is switched on and a wireless connection has been established.

6.5.3.2 Activating / deactivating sleep mode

The PR 300-HV2S saves power when in sleep mode. The laser is switched off, thereby extending battery life.

1. Press the “Menu” key  on the PRA 300.
2. Select system setup .
3. Use the arrow keys   to navigate to the option “Sleep mode” .
4. Confirm your selection by pressing the OK key **OK**.

5. Activate / deactivate sleep mode by pressing the OK key .
- NOTE** All settings remain saved.

6.5.4 Tool settings		
 Shock warning sensitivity		High vibration, low sensitivity to shock
		Medium
		Low
% <hr/> ‰ Inclined plane mode units		Percent
		Degrees
		Thousandths
		Millimeters
mm <hr/> in Units		Inches
		On
Wireless connection		Off

en



Settings that affect the rotating laser only become effective when the rotating laser is switched on and a wireless connection has been established. Pressing the “Back” key  takes you back to the main menu.

6.5.4.1 Deactivating the shock warning function

1. Switch the rotating laser on (see 6.3).
2. Press the “Deactivate shock warning” key .
The shock warning deactivation LED lights constantly, indicating that the function has been deactivated.
If the shock warning function is deactivated, the tool no longer reacts to shock (i.e. when bumped or shaken).
3. To return to standard operating mode, switch the tool off and then switch it back on again.



6.5.4.2 Inclined plane mode units

Under “Inclined plane mode units” the units to be used when entering an inclination can be set to percent, degrees or thousandths.

1. Press the “Menu” key  on the PRA 300.
2. Choose the “Settings” key .
3. Use the arrow keys to select “Inclined plane mode units” $\frac{\%}{‰}$.
4. Confirm your selection by pressing the **OK** key.
5. Choose the correct units and activate these by pressing the **OK** key.



6.5.4.3 Units

This item in the menu lets you choose between metric and imperial units.

1. Press the “Menu” key  on the PRA 300.
2. Choose the “Settings” key .
3. Press one of the arrow keys to select “Units” $\frac{mm}{in}$.
4. Confirm your selection by pressing the **OK** key.
5. Choose the correct units and activate these by pressing the **OK** key.



6.5.4.4 Wireless connection

If necessary, you can deactivate the receiver’s wireless connection and then use the receiver / remote control unit simply as a receiver.

1. Press the “Menu” key  on the PRA 300.
2. Choose the “Settings” key .
3. Use the arrow keys to select the “Wireless connection” option .
4. Confirm your selection by pressing the **OK** key.
5. Choose the correct wireless connection and activate this by pressing the **OK** key.

6.5.5 Information

When this menu item is selected you have the following options:

	The software version of the tool, receiver and PRA 90 can be viewed here.
Software version	
	The date of the last calibration can be viewed here.
Date of last calibration	
	The QR code, which can be scanned with a smartphone, is linked to animation videos that explain how to operate the system.
QR code	

You can leave the menu again at any time by pressing the “Menu” key  or the “Back” key .

6.6 Working in the horizontal plane

6.6.1 Setting up

1. Set up the tool in a suitable position for the application, e.g. on a tripod. Alternatively, the rotating laser may be mounted on a wall bracket. The angle of inclination of the surface on which it stands should not exceed $\pm 5^\circ$.
2. Press the on/off button .

The “auto leveling” LED blinks green and the leveling status is shown in the display on the laser receiver. The laser switches on, the beam begins to rotate and the “auto leveling” LED lights as soon as the tool has leveled itself.

6.6.2 Alignment using the PRA 90 automatic tripod

NOTE

This function is available only with the PRA 90 automatic tripod.

When used for the first time, the PRA 300 laser receiver must be paired with the tripod (see 6.9.2).

With the optional PRA 90 automatic tripod you can set the height of the laser plane to the desired level manually or automatically.

1. Mount the tool on the PRA 90 automatic tripod.
2. Switch on the rotating laser, the automatic tripod and the laser receiver. Set the height of the laser plane manually (see 6.6.2.1) or automatically (see 6.6.2.2).

en

6.6.2.1 Manual alignment

Press the   keys on the laser receiver or the arrow keys on the PRA 90 to shift the horizontal plane up or down (parallel).

6.6.2.2 Automatic alignment

1. Hold the laser receiver at the desired height with the detection area facing the PRA 90 control panel. Hold the laser receiver still while alignment is taking place and take care to ensure that the line of sight between the laser receiver and the tool is not obstructed.
2. Press the “Automatic alignment” key  on the laser receiver twice in quick succession (double-click). Double-click the key again to complete the procedure.

The laser plane alignment process is then started, i.e. the tripod elevates or lowers itself to the required height. A constant signal tone is emitted while this is taking place. As soon as the laser beam strikes the detection area of the laser receiver, the beam moves to the position of the marking notch (reference plane).

After the position has been reached and the rotating laser has leveled itself, a signal tone with a duration of 5 seconds indicates that the process is complete. The “Automatic alignment” symbol  is then no longer shown.



3. Check the height settings in the display.
4. Remove the laser receiver.
NOTE If the automatic alignment process was not successful, short signal tones are emitted and the “Automatic alignment” symbol  disappears.
NOTE A warning is also displayed on the laser receiver indicating that the receiver is outside the possible receiving area.

6.7 Working in the vertical plane

1. When working in the vertical plane, mount the tool on a suitable tripod, facade adapter, batter board adapter or wall bracket, with the control panel facing upwards. Alternatively, the tool can be stood on the rubber feet on the rear grips.
NOTE The best wireless connection with the PRA 300 is provided by the side of the tool to the right of the control panel.
NOTE In order to ensure that the tool's specified accuracy can be maintained, make sure that it is set up on a level surface or mounted sufficiently level on the tripod or other accessory.
2. Use the visual sighting method (front and rear sights) to align the rotating laser in the desired direction.

3. Press the on/off button .



After the tool has leveled itself automatically, it projects a stationary laser beam vertically downwards. This projected point is a reference point (not a plumb point) and can be used to help position the tool.

4. Align the tool so that the projected laser point coincides exactly with a reference point (e.g. nail on a batter board).
5. Now line up the laser plane with the second reference point manually (see 6.7.1) or automatically (see 6.7.2). The laser begins to rotate automatically as soon as you begin the alignment operation.

6.7.1 Manual alignment 13

1. Press the arrow keys  on the laser receiver in order to align the vertical plane manually.

6.7.2 Automatic alignment and surveillance 14

1. Mount or hold the laser receiver with the marking notch at the desired alignment point and facing the rotating laser.
2. Double-click the “Automatic alignment” key . Double-click the key again to complete the procedure. The laser plane alignment procedure then begins. A constant signal tone is emitted while this is taking place. The direction of the search can be changed by pressing the “Automatic alignment” key  once. As soon as the laser beam strikes the detection area of the laser receiver, the beam moves to the position of the marking notch (reference plane). Once the position is reached (i.e. the marking notch is found), a signal tone with a duration of 5 seconds indicates that the process is complete. The laser receiver switches automatically to surveillance mode and checks at regular intervals whether the laser plane has shifted. If it is found to have shifted, the laser plane will be readjusted to the original marking notch as far as possible. If the marking plane is outside the leveling range of $\pm 5^\circ$, direct line of sight between the rotating laser and the laser receiver is obstructed for a long period or the alignment process is not completed successfully within a time of 2 minutes, then short signal tones are emitted, the laser stops rotating and the “Automatic alignment” symbol disappears. This indicates cancellation of the automatic alignment process.







3. After the automatic alignment process is completed and, instead of leaving the receiver in position, you wish to use the device again as a receiver, you can leave surveillance mode again by pressing the “Automatic alignment” key  twice in quick succession (double click).

6.8 Working with slopes

NOTE

If the tool measures a change in temperature of more than 10 degrees, laser rotation stops for about 40 seconds. During this time the tool corrects all errors that may have been caused by the temperature change. After this automatic correction the tool resets the laser plane to the previous inclination and the laser again begins to rotate.



	Tool is level
	Leveling switched off in order to work with the slope adapter

	Last previously used inclination value
	X-axis
	Y-axis



en

The inclination can be set manually, automatically, or by using the PRA 79 slope adapter.

6.8.1 Setting up

1. Mount the rotating laser on a tripod.
2. Position the rotating laser at the first reference point either at the upper edge or lower edge of the inclined plane.
3. Position yourself behind the tool, facing the control panel.
4. With the aid of the visual sighting method (using the front and rear sights on the head of the tool), aim the tool roughly at the second reference point, keeping it parallel to the inclined plane.
5. Switch the laser receiver on .
6. Switch the tool on  and then press the "Inclined plane mode" key .

The "Inclined plane mode" LED then lights.
The laser beam switches on as soon as the tool has leveled itself. The control panel of the PRA 300 then offers the following ways of adjusting the inclination:









 - Digital adjustment of the X or Y values .
 - Switch off the leveling control (to allow use with the PRA 79 slope adapter)
 - Recall the last previously used value .

For more precise adjustment, first set the inclination and then carry out automatic or manual electronic inclination alignment (see 6.8.2.2). Inclination can be set and displayed on the PRA 300 in %, ‰ or in ° (see 6.5.4).

6.8.2 Setting the inclination manually (digital entry)

Inclination values of up to 20% can be entered with the laser receiver / remote control unit. The display on the laser receiver shows the angle of inclination. If a slope adapter or an already inclined tripod is also used, inclinations of up to 25% can be achieved.

You can set the X and Y inclinations at the same time or for just one of the two axes.

1. Use the arrow keys  or  to select soft key X and then confirm your choice by pressing **OK**.
2. Then use the arrow keys  or  to select the digit or character that you wish to set and activate it by pressing **OK**.
3. Enter the desired value by way of the arrow keys  or  and confirm each digit by pressing **OK** – only then can a new digit be selected.
4. After entering the desired value, confirm your input by pressing **OK**.
5. Use the arrow keys to navigate to the OK key  and press **OK**.
6. You can now enter the Y-value or go straight to "Confirm" . The laser beam will be adjusted only when you confirm this step.
NOTE Alternatively, before confirming, you can press the "Back" key  and return to the main menu, thereby deleting the entries you have made.

6.8.2.1 Optional automatic electronic inclination alignment

After aligning the rotating laser approximately and setting the inclination as described above, alignment of the PR 300-HV2S can be optimized through use of Hilti's patented automatic electronic alignment system.

1. Position the PRA 300 laser receiver centrally opposite the PR 300-HV2S rotating laser at the end of the inclined plane on the second reference mark. It can be held still by hand or fixed in place with the aid of the PRA 83 receiver holder.

2. After entering the inclination on the PRA 300, double-click the AUTO key to select the Auto E-targeting function and confirm your selection by pressing **OK**.

The animation shown on the PRA 300 indicates how automatic alignment is proceeding. As soon as this is completed, alignment with the PRA 300 is correct.

After successful alignment, the function is ended automatically and the laser is aimed at the receiving window on the receiver.

There may be divergence between the results obtained by approximate alignment with the aid of the visual sighting method (using the front and rear sights) and fine alignment with the aid of automatic electronic inclination alignment. As the automatic electronic method using the tool is more accurate than the visual method, we recommend that electronic inclination alignment is always used as the reference.

It can always be seen from the menu bar that Auto E-targeting has been used. If the system is switched off, the divergence from the result obtained using the visual sighting method is canceled.

The laser first searches for the receiver in the X-axis and then in the Y-axis. Targeting can take place only within an angle of +/- 5°.

6.8.2.2 Optional manual electronic inclination alignment

After aligning the rotating laser approximately and setting the inclination as described above, alignment of the PR 300-HV2S can be optimized through use of Hilti's patented manual electronic alignment system.

1. Position the PRA 300 centrally opposite the PR 300-HV2S at the end of the inclined plane. It can be held still by hand or fixed in place with the aid of the PRA 83.

NOTE The detection area must be aligned with the second reference point.

2. Activate manual electronic inclination alignment on the PR 300-HV2S by pressing the "Electronic inclination alignment" key.

If the arrows for electronic inclination alignment blink, the PRA 300 is receiving no laser beam from the PR 300-HV2S.

3. If the left arrow lights, turn the PR 300-HV2S clockwise.
4. If the right arrow lights, turn the PR 300-HV2S counter-clockwise.

When both arrows light, the PRA 300 is correctly aligned.

After successful alignment (both arrows light constantly for 10 seconds), the function ends automatically.

5. Then secure the rotating laser on the tripod so that it cannot be inadvertently moved out of position.
6. You can also end electronic inclination alignment by pressing the "End manual electronic inclination alignment" key.

NOTE There may be divergence between the results obtained by approximate alignment with the aid of the visual sighting method (using the front and rear sights) and fine alignment with the aid of manual electronic inclination alignment. As the manual electronic method is more accurate than the visual method, we recommend that electronic inclination alignment is always used as the reference.

6.8.3 Measuring a given inclination automatically

With this function you can create an inclined laser plane between 2 points automatically and determine the angle of inclination between these points.

1. Set up the rotating laser at the top edge of the inclined plane as described in 6.8.1.
2. Mount the laser receiver with the PRA 83 receiver holder, for example, on the PUA 53 telescopic staff.
3. Position the receiver immediately in front of the rotating laser, bring it into alignment with the laser plane at the correct height, and then secure it at the second reference point on the telescopic staff.
4. Position the receiver on the telescopic staff at the lower edge of the inclined plane, click the "Automatic alignment" key **auto** and confirm this by pressing **OK**.

NOTE Double-click the AUTO key again to complete the alignment procedure.

The laser plane alignment procedure then begins. A constant signal tone is emitted while this is taking place.

5. The direction of the search can be changed by pressing the "Automatic alignment" key **auto** once. As soon as the laser beam strikes the detection area of the laser receiver, the beam is fixed at the position of the marking notch (reference plane). Once the position is reached (i.e. the marking notch is found), a signal tone with a duration of five seconds indicates that the process is complete.

The "Automatic alignment" symbol is no longer shown in the display on the laser receiver and the receiver switches automatically to normal operating mode.

The new inclination is shown in the display on the laser receiver.



6. Read the inclination between the two points (positions of the rotating laser and the laser receiver) from the display of the laser receiver.

NOTE Optionally, following this, Auto E-targeting can be carried out. 6.8.2.1

6.8.4 Setting the inclination with the aid of the PRA 79 slope adapter

NOTE

Check that the slope adapter is fitted correctly between the tripod and the tool (please refer to the operating instructions for the PRA 79).



1. Set up the PRA 79 slope adapter in a suitable position for the application, e.g. on a tripod.
2. Position the tripod either at the upper edge or lower edge of the inclined plane.
3. Mount the rotating laser on the slope adapter and, with the aid of the sights on the head of the PR 300-HV2S, adjust the tool and slope adapter so that they are parallel to the inclined plane. The control panel of the PR 300-HV2S should face away from the direction of inclination.
4. Make sure that the slope adapter is in the zero position (0°).
5. Switch the tool on (see 6.3).
6. Press the “Inclined plane mode” key .
The “Inclined plane mode” LED then lights on the control panel of the rotating laser.
The tool then begins automatic self-leveling. The laser switches on and begins to rotate as soon as this is complete.
7. On the receiver, now press  to deactivate the leveling function.
8. Set the slope adapter to the desired angle of inclination.

NOTE When the angle of inclination is set manually, the PR 300-HV2S levels the laser plane once and then subsequently fixes it. Vibration, changes in temperature or other influences that may occur during the course of the day may affect the position of the laser plane.

NOTE In order to enter digital manual settings for X/Y, you must first set the tool to the standard operating mode. To do this, the system must be restarted.

6.9 Recalling the last previous value

If you switch the tool off to reposition it, the last previous inclination value saved in the receiver can be recalled.

1. Switch the tool on again  and activate inclined plane mode .
The first item in the menu is the last previous value.
2. Press **OK** to select the value.
3. Check that the X and Y-values are, in fact, correct.
4. Confirm the values by pressing **OK**.
The rotating laser then resets itself to the previous inclination.

6.10 Resetting the X/Y value

Use the “Reset to 0” soft key to quickly reset the X and Y-values to 0.

6.11 Returning to standard mode

To return to standard operating mode, switch the tool off and then switch it back on again.

7 Care and maintenance

7.1 Cleaning and drying

1. Blow dust off exit windows.
2. Do not touch the glass with the fingers.
3. Use only a clean, soft cloth for cleaning. If necessary, moisten the cloth slightly with pure alcohol or a little water.
NOTE Abrasive cleaning materials may scratch the glass and impair the accuracy of the laser tool.
NOTE Do not use any other liquids as these may damage the plastic components.
4. Dry the equipment, observing the maximum temperatures given in the technical data.
NOTE Especially in summer and winter, take care that the given maximum and minimum temperatures are not exceeded, e.g. when the equipment is stored in a motor vehicle.

7.2 Care of Li-ion batteries

NOTE

With Li-ion batteries, a conditioning charge (as is required with NiCd or NiMH batteries) is not necessary.

NOTE

Interruption of the charging procedure has no negative effect on battery life.

NOTE

Charging can be started at any time with no negative effect on battery life. There is no memory effect (in contrast to NiCd or NiMH batteries).

NOTE

For best results, batteries should be stored fully charged in a cool, dry place. Storing the battery in places subject to high ambient temperatures (e.g. at a window) has an adverse effect on battery life and increases the rate of self-discharge.

NOTE

Batteries lose capacity due to aging and overstressing. They can then no longer be fully charged. You may continue to work with a battery that shows signs of aging, but the battery should be replaced in good time.

1. Avoid ingress of moisture.
2. Charge the battery fully before using it for the first time.
3. Charge the battery as soon as performance drops noticeably.

NOTE Recharging in good time will increase the service life of the battery.

NOTE If use of the battery continues, further discharge will be stopped automatically before the battery cells suffer damage, i.e. the tool switches itself off.

4. Charge the batteries using only the Hilti chargers approved for use with Li-ion batteries.

7.3 Storage

1. Remove the tool from its case if it has become wet. Dry and clean the tool, its transport container and accessories (while observing the permissible temperature range). Repack the equipment only once it is completely dry.
2. Check the accuracy of the equipment before it is used after a long period of storage or transportation.
3. Remove rechargeable and non-rechargeable batteries from the tool or the laser receiver before storing the units for long periods. The tool or laser receiver may suffer damage caused by leakage from rechargeable or non-rechargeable batteries.

7.4 Transport

Use the Hilti toolbox or packaging of equivalent quality for transporting or shipping your equipment.

CAUTION

Always remove the batteries before shipping the tool.

7.5 Hilti Measuring Systems Service

Hilti Measuring Systems Service checks the tool and, if deviations from the specified accuracy are found, recalibrates the tool and checks it again to ensure conformity with specifications. The service certificate provides written confirmation of conformity with specifications at the time of the test.

The following is recommended:

1. The tool should be checked at suitable intervals, depending on the frequency of normal use.
2. The tool should be checked at least once a year by a Hilti Measuring Systems Service Center.

3. The tool should be checked by a Hilti Measuring Systems Service Center if it has been abused in any way.
4. The tool should be checked by a Hilti Measuring Systems Service Center before being used for particularly important work.

Having the tool checked by a Hilti Measuring Systems Service Center does not relieve the user of his/her obligation to check the tool before and during use.

7.6 Checking accuracy

NOTE

In order to ensure compliance with the technical specifications, the tool should be checked regularly (at least before each major / relevant job).

NOTE

After falling and suffering an impact it can be assumed that the tool will continue to operate faultlessly, with the accuracy it achieved prior to the impact, when the following conditions are met:

The height of the fall did not exceed the height given in the technical data.

The tool suffered no obvious mechanical damage from the impact (e.g. breakage of the pentaprism).

The tool projects a rotating laser beam when in operation. The tool operated faultlessly before the impact.

7.6.1 Checking the main and transverse horizontal axes

1. Set up the tripod approx. 20 m from a wall and level the tripod head with a spirit level.
2. Mount the tool on the tripod and use the visual sighting method (front and rear sights) to aim the tool at the wall.
3. Use the receiver to catch the laser beam and mark a point (point 1) on the wall.
4. Pivot the tool clockwise through 90° about its own axis. In doing so, ensure that the height of the tool does not change.
5. Use the laser receiver to catch the laser beam and mark a second point (point 2) on the wall.
6. Repeat steps 4 and 5 twice and mark points 3 and 4 on the wall with the aid of the laser receiver. When this procedure is carried out carefully, the vertical distance between the two marked points 1 and 3 (main axis) or, respectively, points 2 and 4 (transverse axis) should be less than 2 mm (at 20 m). If the deviation is greater than this, the tool should be returned to a Hilti Service Center for calibration.

7.6.2 Checking the vertical axis











1. Place the tool in the vertical position on a flat floor approx. 10 m from a wall.
2. Adjust the position of the tool so that the grips are parallel to the wall.
3. Switch the tool on and mark the reference point (R) on the floor.





4. With the aid of the receiver, mark point (A) low on the wall.
5. With the aid of the receiver, mark point (B) at a height of approx. 10 m.
6. Pivot the tool through 180° and realign it with the reference point (R) on the floor and with point (A) at the base of the wall.
7. With the aid of the receiver, mark point (C) at a height of approx. 10 m.
8. Check the distance between points (B) and (C). When the procedure has been carried out carefully, the horizontal distance between the two points (B) and (C) marked at a height of 10 meters should be less than 1 mm (at 10 m).

NOTE If the deviation is greater: Please return the tool to Hilti Service for calibration.

8 Troubleshooting

Every item shown in the display is accompanied by either the “Information” or the “Warning” symbol (see section “Overview of general symbols”).

Message displayed	Fault	Possible cause	Remedy
 Inclination angle too high.	The tool cannot achieve the given inclination.	Inclination angle too high	Reposition the tool so that the inclination value you have entered can be achieved.
 Rotating laser in wrong position.	The tool cannot level itself.	The tool is not correctly positioned – is already too steeply inclined.	The tool must be repositioned in order to bring it within the leveling range.
 Rotating laser shock	The tool has been subjected to shock.	The rotating laser has been subjected to shock – accuracy can no longer be guaranteed.	Restart the system and take a reference measurement before continuing your work.
 Surveillance interrupted	Surveillance between the tool and the laser receiver has been interrupted.	The receiver has received no laser beam for more than 2 minutes.	The tool must be restarted and alignment of the vertical laser beam then carried out again.
 Receiver battery symbol	The receiver's battery is almost empty.	The receiver's battery is almost empty.	Charge the battery soon.
 Rotating laser battery symbol	The rotating laser's battery is almost empty.	The rotating laser's battery is almost empty.	Charge the battery soon.
 Tripod battery symbol	The tripod's battery is almost empty.	The tripod's battery is almost empty.	Charge the battery soon.
 Autoalignment	The Autoalignment process was canceled.	The receiver could find no laser beam within 2 minutes.	The process must be restarted.
 Auto E-targeting	Auto E-targeting cannot be started.	The receiver is outside the Auto E-targeting range.	Hold the receiver within the laser beam.
 Autoalignment not possible	Autoalignment is not possible at the moment.	Autoalignment is not possible while certain menu items are being executed.	Close the current menu and try again.

Message displayed	Fault	Possible cause	Remedy
 Receiver battery symbol	The receiver's battery is empty.	The receiver's battery is empty.	Charge the battery.
 Rotating laser battery symbol	The rotating laser's battery is empty.	The rotating laser's battery is empty.	Charge the battery.
 Tripod battery symbol	The tripod battery is empty.	The tripod's battery is empty.	Charge the battery.
 Display symbol	Auto E-targeting is not taking place.	The receiver is outside the Auto E-targeting range.	Hold the receiver within the laser beam.
 Auto E-targeting was not successful	Auto E-targeting was not successful.	Auto E-targeting cannot be completed.	Restart the Auto E-targeting function.

9 Disposal

WARNING

Improper disposal of the equipment may have serious consequences:

The burning of plastic components generates toxic fumes which may present a health hazard.

Batteries may explode if damaged or exposed to very high temperatures, causing poisoning, burns, acid burns or environmental pollution.

Careless disposal may permit unauthorized and improper use of the equipment. This may result in serious personal injury to third parties and pollution of the environment.



Most of the materials from which Hilti tools or appliances are manufactured can be recycled. The materials must be correctly separated before they can be recycled. In many countries, Hilti has already made arrangements for taking back old tools and appliances for recycling. Ask Hilti customer service or your Hilti representative for further information.



For EC countries only

Do not dispose of electronic measuring tools or appliances together with household waste.

In observance of the European Directive on waste electrical and electronic equipment and its implementation in accordance with national law, electrical appliances and batteries that have reached the end of their life must be collected separately and returned to an environmentally compatible recycling facility.



Dispose of the batteries in accordance with national regulations.

10 Manufacturer's warranty - tools

Please contact your local Hilti representative if you have questions about the warranty conditions.

11 EC declaration of conformity (original)

Designation:	Rotating laser
Type:	PR 300-HV2S
Generation:	01
Year of design:	2014

We declare, on our sole responsibility, that this product complies with the following directives and standards: 2011/65/EU, 2006/42/EC, 2006/66/EC, 1999/5/EC, EN ISO 12100, until 19th April 2016: 2004/108/EC, from 20th April 2016: 2014/30/EU, EN 300 440-2 V1.4.1, EN 301 489-1 V1.9.2, EN 301 489-17 V2.2.1.

Hilti Corporation, Feldkircherstrasse 100,
FL-9494 Schaan



Paolo Luccini
Head of BA Quality and Process Management
Business Area Electric Tools & Accessories
05/2015



Edward Przybyłowicz
Head of BU Measuring Systems
BU Measuring Systems
05/2015

Technical documentation filed at:

Hilti Entwicklungsgesellschaft mbH
Zulassung Elektrowerkzeuge
Hiltistrasse 6
86916 Kaufering
Deutschland

en



Hilti Corporation

LI-9494 Schaan

Tel.: +423/234 21 11

Fax: +423/234 29 65

www.hilti.com

Hilti = registered trademark of Hilti Corp., Schaan
Pos. 1 | 20150716



2108730