

HILTI

GX 2

English



1	Information about the documentation	2
1.1	About this documentation	2
1.2	Explanation of symbols used	2
1.2.1	Warnings	2
1.2.2	Symbols in the documentation	2
1.2.3	Symbols in the illustrations	2
1.3	Product-dependent symbols	2
1.3.1	Symbols on the product	2
1.3.2	Highlighting of designations and markings	3
1.4	Product information	3
1.5	Declaration of conformity	3
2	Safety	3
2.1	Safety instructions	3
3	Description	8
3.1	Overview of the product	8
3.2	Intended use	9
3.3	Items supplied	9
3.4	Fastener guide	9
3.5	Slider for fastener driving depth adjustment and for releasing the fastener guide	9
3.6	Support leg	9
3.7	Belt hook	9
3.8	Gas can	10
3.9	Indication of gas can status	10
3.10	Indication of battery charge status	10
4	Technical data	10
4.1	Fastening tool	10
4.2	Noise information and vibration values	11
5	Loading the fastening tool	11
5.1	Equipment required for driving nails	11
5.2	Loading the magazine	11
5.3	Inserting the gas can	11
5.4	Inserting the battery	11
6	Driving nails	12
7	Unloading the fastening tool	12
7.1	Removing the battery	12
7.2	Removing the gas can	12
7.3	Unloading the magazine	12
8	Optional operating steps	13
8.1	Removing the transport safety device from a new gas can	13
8.2	Checking the status of the gas can	13
8.3	Removing the magazine	13
8.4	Fitting the magazine	13
8.5	Removing the fastener guide	14
8.6	Inserting the fastener guide	14
8.7	Removing the support leg	14
8.8	Fitting the support leg	14
9	Remedying possible malfunctions	14
9.1	Removing foreign objects from the area of the fastener guide	14

10	Care and maintenance	14
10.1	Caring for the fastening tool	14
10.2	Cleaning the fastening tool	15
10.3	Maintenance	15
10.4	Checks after care and maintenance work	15
11	Troubleshooting	15
12	Disposal	17
13	Manufacturer's warranty	17

1 Information about the documentation



1.1 About this documentation

- Read this documentation before initial operation or use. This is a prerequisite for safe, trouble-free handling and use of the product.
- Observe the safety instructions and warnings in this documentation and on the product.
- Always keep the operating instructions with the product and make sure that the operating instructions are with the product when it is given to other persons.

1.2 Explanation of symbols used



1.2.1 Warnings

Warnings alert persons to hazards that may occur when handling or using the product. The following signal words are used in combination with a symbol:

	DANGER! Draws attention to an imminent hazard that will lead to serious personal injury or fatality.
	WARNING! Draws attention to a potential hazard that could lead to serious personal injury or fatality.
	CAUTION! Draws attention to a potentially dangerous situation that could lead to minor personal injury or material damage.



1.2.2 Symbols in the documentation

The following symbols are used in this document:

	Read the operating instructions before use
	Instructions for use and other useful information

1.2.3 Symbols in the illustrations

The following symbols are used in illustrations:





2	These numbers refer to the corresponding illustrations found at the beginning of these operating instructions.
3	The numbering reflects the sequence of operations shown in the illustrations and may deviate from the steps described in the text.
	Item reference numbers are used in the overview illustration and refer to the numbers used in the key in the product overview section.
	This symbol is intended to draw special attention to certain points when handling the product.

1.3 Product-dependent symbols

1.3.1 Symbols on the product

The following symbols are used on the product:

	General mandatory sign
---	------------------------

	Wear eye protection
	Wear ear protection
	Wear a hard hat
	Return waste material for recycling

1.3.2 Highlighting of designations and markings

Designations and markings are indicated as follows:

, '	Description of marked operating controls on the fastening tool
« »	Markings on the fastening tool

1.4 Product information

Hilti products are designed for professional use and may be operated, serviced and maintained only by trained, authorized personnel. This personnel must be informed of any particular hazards that may be encountered. The product and its ancillary equipment can present hazards if used incorrectly by untrained personnel or if used not in accordance with the intended use.

The type designation and serial number are stated on the rating plate.

- ▶ Write down the serial number in the table below. You will be required to state the product details when contacting Hilti Service or your local Hilti organization to inquire about the product.

Product information

Fastening tool, gas-actuated	GX 2
Generation:	01
Serial number:	

1.5 Declaration of conformity

We declare, on our sole responsibility, that the product described here complies with the applicable directives and standards. A copy of the declaration of conformity can be found at the end of this documentation.

The technical documentation is filed and stored here:

Hilti Entwicklungsgesellschaft mbH | Tool Certification | Hiltistraße 6 | 86916 Kaufering, DE

2 Safety

2.1 Safety instructions

Working safely with the fastening tool

- ▶ Pressing the nosepiece of the fastening tool against a part of the body may lead to serious injury due to inadvertent actuation and release of a fastener. **Never press the nosepiece of the tool against your hand or any other part of the body.**
- ▶ When inserting/loading application-specific fasteners (e.g. washers, clips or clamps, etc.) in/on the fastener guide there is a risk of serious injury due to inadvertent actuation of the tool resulting in discharge of a fastener. **When inserting/loading an application-specific type of fastener, never press a hand or any other part of the body against the fastener guide.**
- ▶ **Never point the fastening tool towards yourself or any other person.**
- ▶ **Keep your arms flexed when operating the tool (do not straighten the arms).**
- ▶ When pulling back the nail pusher, always take care to ensure that it engages.
- ▶ **When disengaging the nail pusher, do not release it and allow it to jump forward. Guide it forward slowly.** There is a risk of pinching the fingers.
- ▶ Do not attempt to drive fasteners into **materials that are too hard**, such as welded steel or cast steel. Attempting to drive fasteners into these materials may lead to malfunctions, incorrectly driven fasteners or breakage of fasteners.
- ▶ Do not attempt to drive fasteners into **materials that are too soft**, such as wood or drywall/gypsum board. Attempting to drive fasteners into these materials may lead to malfunctions and fasteners being driven incorrectly or driven right through the material.

- ▶ Do not attempt to drive fasteners into **materials that are too brittle**, such as glass or tiles. Attempting to drive fasteners into these materials may lead to malfunctions, fasteners being driven incorrectly and may cause the material to shatter.
- ▶ Before driving fasteners, check that there is no risk of injuring persons or of damaging objects present behind or below the working surface.
- ▶ Pull the safety trigger only when the fastening tool is pressed against the working surface in such a way that the fastener guide is pushed into the tool as far as it will go.
- ▶ **Always wear gloves if you have to carry out maintenance work on the fastening tool while it is still hot.**
- ▶ If fasteners are driven at a high rate or if the tool used for a long period, surfaces of the tool beyond the grip areas may get hot. Wear protective gloves to avoid burning injuries.
- ▶ If the fastening tool overheats, remove the gas can and allow the tool to cool down. Do not exceed the specified maximum fastener driving rate.
- ▶ Driving fasteners may cause flying fragments or result in parts of the nail strip material being forcibly ejected from the tool. Flying fragments present a risk of injury to the body and eyes. **Wear eye protection, ear protection and a hard hat.** Depending on the application and type of fastening tool in use, wearing personal protective equipment such as a dust mask, non-slip safety footwear, hard hat and ear protection reduces the risk of injury. Other persons in the vicinity must also wear eye protection and a hard hat.
- ▶ Wear suitable ear protection (see noise information in the technical data section). Fasteners are driven through ignition of a gas/air mixture. The resulting noise exposure may cause damage to the hearing. Other persons in the vicinity should also wear suitable hearing protection.
- ▶ When driving a fastener, always hold the fastening tool securely and at right angles to the supporting material. This helps to avoid deflection of the fastener by the supporting material.
- ▶ Never drive a second fastener at the same location. This may lead to breakage or jamming of fasteners.
- ▶ Always remove the gas can (→ page 12) and battery (→ page 12) and empty the magazine (→ page 12) before changing the magazine or before cleaning, servicing or maintenance work on the tool, before storage or transport and before leaving the fastening tool unattended.
- ▶ To ensure that the fastening tool functions faultlessly and as intended, always check the tool and accessories for possible damage before use. Check that moving parts function faultlessly, without sticking, and that no parts are damaged. In order to ensure faultless operation of the fastening tool, all parts must be fitted correctly and must meet the necessary requirements. Damaged protective devices or other parts must be properly repaired or replaced by **Hilti Service** unless otherwise stated in the operating instructions.
- ▶ Have the fastening tool repaired only by trained and qualified specialists using genuine Hilti spare parts. This will ensure that the safety of the fastening tool is maintained.
- ▶ Tampering with or modification of the fastening tool is not permissible.
- ▶ **Do not use the fastening tool where there is a risk of fire or explosion.**
- ▶ Take influences of the surrounding area into account. Do not expose the fastening tool to rain or snow and do not use it in damp or wet conditions.
- ▶ Use the fastening tool only in well-ventilated working areas.
- ▶ Select the correct combination of fastener guide and fastener. The wrong combination may result in damage to the tool and in reduced fastening quality.
- ▶ Always observe the application guidelines .

Hazards presented by electricity

- ▶ **Before beginning work, check the working area (e.g. using a metal detector) to ensure that no concealed electric cables or gas and water pipes are present.**
- ▶ Hold the fastening tool only by the insulated grip when working in areas where fasteners may be driven inadvertently into concealed electric cables. Contact with a live electric cable may cause metal parts of the fastening tool also to become live, leading to a risk of electric shock.

Use and care of battery-powered tools

- ▶ **Check that the tool is switched off before inserting the battery.** Inserting a battery into an electric tool that is switched on can lead to accidents.
- ▶ **Do not expose batteries to high temperatures, the direct heat of the sun, and keep them away from fire.** There is a risk of explosion.
- ▶ **Do not disassemble, squash or incinerate batteries and do not subject them to temperatures over 80°C.** This presents a risk of fire, explosion or injury through contact with caustic substances.
- ▶ **Avoid ingress of moisture.** Ingress of moisture may cause a short circuit, resulting in burning injuries or fire.

- ▶ **Use only batteries of the type approved for use with the applicable tool.** Use of other batteries or use of the batteries for purposes for which they are not intended presents a risk of fire and explosion.
- ▶ **Observe the special guidelines applicable to the transport, storage and use of Li-ion batteries.**
- ▶ **Remove the battery from the tool before transport or storage.**
- ▶ **Avoid short circuiting the battery terminals. Check that the contacts on the battery and on the tool are free from foreign objects before inserting the battery into the tool.** Short circuiting the battery terminals presents a risk of fire, explosion and chemical burns.
- ▶ **Do not continue to use or attempt to charge damaged batteries (e.g. batteries with cracks, broken parts, bent or pushed-in / pulled-out contacts).**
- ▶ A battery that is too hot to hold may be defective. Allow the battery to cool down in a place where there is no risk of causing a fire. Check that there are no flammable materials nearby. Contact Hilti Service.

Instructions for handling the propellant gas

- ▶ Observe the instructions printed on the gas can and in the accompanying information.
- ▶ Escaping gas is harmful to the lungs, skin and eyes. Keep your face and eyes away from the gas can compartment for up to about 10 seconds after removing the gas can.
- ▶ Do not operate the gas can valve manually.
- ▶ If a person has inhaled gas, take the person into the open air or into a well-ventilated area and place the person in a comfortable position. Consult a doctor if necessary.
- ▶ **Call a doctor if the person is unconscious.** Bring the person into a well-ventilated area and place the person in the stable recovery position (i.e. lying on the side). If the person is not breathing, administer artificial respiration and, if necessary, supply oxygen.
- ▶ After eye contact with gas, rinse the open eyes thoroughly under running water for several minutes.
- ▶ After skin contact with gas, wash the contact area carefully with soap and warm water. Subsequently apply a skin cream.

General instructions concerning personal safety

- ▶ Take care to adopt an ergonomic body position. Work from a safe stance and take care to stay in balance at all times. This will allow you to control the fastening tool better, even in unexpected situations.
- ▶ Keep other people away from the working area, especially children.

3 Description

3.1 Overview of the product

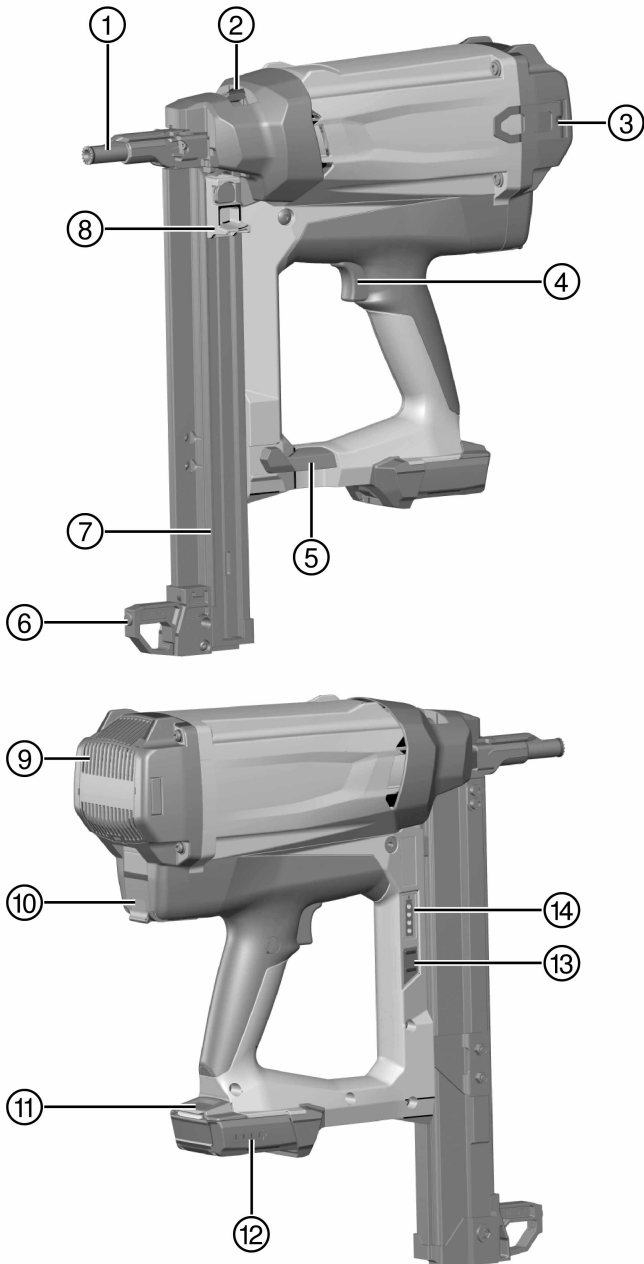

- | | |
|---|-----------------------------------|
| ① Fastener guide | ⑧ Nail pusher |
| ② Slider for fastener driving depth adjustment and for releasing the fastener guide | ⑨ Cooling air slots |
| ③ Belt hook | ⑩ Gas can compartment |
| ④ Safety trigger | ⑪ Battery release button |
| ⑤ Magazine lockbutton | ⑫ Battery charge status display |
| ⑥ Support leg | ⑬ Gas can status indicator button |
| ⑦ Magazine | ⑭ Gas can status indicator |

3.2 Intended use

The product described is a gas-actuated fastening tool. It is designed to drive suitable fasteners (nails) into concrete, steel, concrete-block masonry, sand-lime block, rendered masonry and other materials suitable for use of the direct fastening technique.

The fastening tool, gas can, battery and fasteners form a technical unit. This means that trouble-free fastening with this fastening tool can be ensured only when it is used together with the fasteners, gas cans and batteries specially manufactured for it by **Hilti**. The fastening and application recommendations made by **Hilti** apply only when these conditions are observed.

The fastening tool is for hand-held use only.

- ▶ Use only **Hilti** Li-ion batteries of the B 12 series with this product.
- ▶ Use only **Hilti** battery chargers of the C 4/12-50 series for charging these batteries.

3.3 Items supplied

Gas-actuated fastening tool with fastener guide, 2 batteries, charger, toolbox and operating instructions. Other system products approved for use with this product can be found at your local **Hilti** Center or online at: www.hilti.group

3.4 Fastener guide

The fastener guide holds the studs or, respectively, guides the nails and, when the tool is actuated, thus directs the fasteners into the supporting material at the desired position.

3.5 Slider for fastener driving depth adjustment and for releasing the fastener guide

The slider can be used to reduce the depth to which the fastener is driven. In the **EJECT** position, it releases the fastener guide for removal.

Status	Meaning
+	• Standard fastener driving depth
-	• Reduced fastener driving depth
EJECT	• Fastener guide release

3.6 Support leg

On an even working surface, the support leg makes it easier to hold the fastening tool perpendicular as attention then only has to be paid to lateral alignment. On an uneven or undulating surface it may be necessary to remove the support leg in order to allow the fastener guide to be held perpendicular to the working surface.

3.7 Belt hook

The belt hook can be extended in three stages.

Status	Meaning
Position 1	• Position for attaching to a waist belt
Position 2	• Position for attaching to ladders, scaffolds, platforms, etc.
Position 3	• Belt hook removed

3.8 Gas can



Note

Observe the safety instructions provided with the gas can!

In order to operate the fastening tool, the gas can must be inserted in the gas can compartment.

The gas can status can be read from the LED display after pressing the **GAS** button.

The gas can must be removed before breaks between working, before maintenance and before transporting or storing the fastening tool.

3.9 Indication of gas can status

After pressing the **GAS** button, the LED display indicates the status of the gas can.

Status	Meaning
All four LEDs light green.	<ul style="list-style-type: none">The level is between 100 % and 75 %.
Three LEDs light green.	<ul style="list-style-type: none">The level is between 75 % and 50 %.
Two LEDs light green.	<ul style="list-style-type: none">The level is between 50 % and 25 %.
One LED lights green.	<ul style="list-style-type: none">The level is between 25 % and 10 %.
One LED blinks green.	<ul style="list-style-type: none">Level is below 10 %. Replacement of the gas can is recommended.
One LED blinks green.	<ul style="list-style-type: none">The gas can is empty or is malfunctioning. Replacement of the gas can is recommended. <p>Note Even when the level is indicated as "empty", the gas can, for technical reasons, still contains a little gas.</p>
One LED blinks red.	<ul style="list-style-type: none">No gas can or the wrong type of gas can is present in the fastening tool.

3.10 Indication of battery charge status

After pressing a battery release button, the display shows the status of the battery and the fastening tool.

Status	Meaning
All four LEDs light green.	<ul style="list-style-type: none">Charge status is 75 % to 100 %.
Three LEDs light green.	<ul style="list-style-type: none">Charge status is 50 % to 75 %.
Two LEDs light green.	<ul style="list-style-type: none">Charge status is 25 % to 50 %.
One LED lights green.	<ul style="list-style-type: none">Charge status is 10 % to 25 %.
One LED blinks green.	<ul style="list-style-type: none">Charge status is below 10 %. The fastening tool is ready for operation.
One LED blinks green.	<ul style="list-style-type: none">The fastening tool is overloaded or overheated and thus not ready for operation.

4 Technical data

4.1 Fastening tool

Weight (empty)	3.9 kg
Application temperature, ambient temperature	-10 °C ... 45 °C
Maximum fastener length	39 mm
Fastener diameter	<ul style="list-style-type: none">2.6 mm3.0 mm
Compression stroke	20 mm
Magazine capacity in strips of 10 nails (Magazine capacity)	1 ... 4
Maximum fastener driving frequency (Fasteners per hour)	1,200

Maximum magnetic field strength	-7.6 dB μ A/m
Frequency	13,553 MHz ... 13,567 MHz

4.2 Noise information and vibration values

The sound pressure and vibration values given in these instructions have been measured in accordance with a standardized test and may be used to compare one fastening tool with another. They may be used for a preliminary assessment of exposure. The data given represents the main applications of the fastening tool. However, if the fastening tool is used for different applications, with different accessories or is poorly maintained, the data may vary. This may significantly increase exposure over the total working period. An estimation of the level of exposure should also take into account the periods of time when the tool is not actually in use. This may significantly reduce exposure over the total working period. Prescribe additional safety measures to protect the operator from the effects of noise and/or vibration, such as: maintenance of the direct fastening tool and its additional equipment or accessories, keeping the hands warm, organization of work patterns.

Noise emission values determined in accordance with EN 15895

Emission sound pressure level at the workplace ($L_{pA, 1s}$)	96 dB(A)
Peak sound pressure level at the workplace ($L_{pC, peak}$)	130 dB (C)
Sound (power) level ($L_{WA, 1s}$)	100 dB(A)
Sound level uncertainty	2 dB(A) / 2 dB(C)

Recoil

Energy-equivalent acceleration, ($a_{hw, RMS(3)}$)	Results for 1 mm sheet metal on C40 concrete: 3.69 m/s ²
Uncertainty	0.22 m/s ²

5 Loading the fastening tool

5.1 Equipment required for driving nails

Nails are fed through the magazine in strip form (ready-to-use strips of nails).

5.2 Loading the magazine

1. Pull the nail pusher back until it engages.
2. Slide the nail strips into the magazine as far as they will go.



Note

Strips of short nails could be inadvertently inserted the wrong way round. With short nails, take care to ensure that the tips of the nails point towards the nose of the tool.



WARNING

Risk of finger injury! Fingers could be pinched when the nail pusher is released.

- ▶ When disengaging the nail pusher, do not release it and allow it to jump forward. Guide it forward slowly as far as it will go.

3. Release the nail pusher and guide it forward as far as it will go.

5.3 Inserting the gas can

1. If you are using a new gas can, remove the transport safety device. → page 13
2. Open the gas can compartment cover.
3. Push the gas can (with metering valve fitted) into the red adapter in the gas can compartment.
4. Close the gas can compartment cover.

5.4 Inserting the battery

1. Check that the contacts on the battery and on the fastening tool are undamaged and free from foreign objects.

2. Fit the battery and make sure that it is heard to engage.
 - ◀ Once the battery has been fitted, the charge status LEDs light for a short time.



CAUTION

A falling battery presents a hazard. If the battery is not secured correctly it may drop out and fall while the work is in progress.

- ▶ Check that the battery is seated securely.

3. Check that the battery is securely seated in the fastening tool.

6 Driving nails



WARNING

Risk of injury! Pressing the nosepiece of the fastening tool against a part of the body may lead to serious injury due to inadvertent firing and release of a fastener.

- ▶ **Never press the nosepiece of the tool against your hand or any other part of the body.**

1. Check the fastener driving depth setting.
2. Bring the nosepiece of the fastening tool and the support leg into contact with the working surface.
3. Press the fastening tool against the working surface as far as it will go (until fully compressed).
4. Check that the fastener guide is perpendicular to the working surface.
5. Pull the safety trigger to drive a fastener.



Note

It is not possible to drive a fastener if the fastening tool is not pressed fully against the working surface.

6. Lift the fastening tool completely away from the working surface after driving a fastener.
7. Remove the gas can (→ page 12) and battery (→ page 12) and empty the magazine (→ page 12) when work with the fastening tool is finished or before leaving the tool unattended.

7 Unloading the fastening tool

7.1 Removing the battery

- ▶ Press both battery release buttons at the same time and pull the battery out of the fastening tool.

7.2 Removing the gas can

1. Open the gas can compartment.
2. Remove the gas can.
3. Close the gas can compartment.

7.3 Unloading the magazine

1. Pull the nail pusher back until it engages.
2. Remove all nail strips from the magazine.



WARNING

Risk of finger injury! Fingers could be pinched when the nail pusher is released.

- ▶ When disengaging the nail pusher, do not release it and allow it to jump forward. Guide it forward slowly as far as it will go.

3. Release the nail pusher and guide it forward as far as it will go.

8 Optional operating steps

8.1 Removing the transport safety device from a new gas can

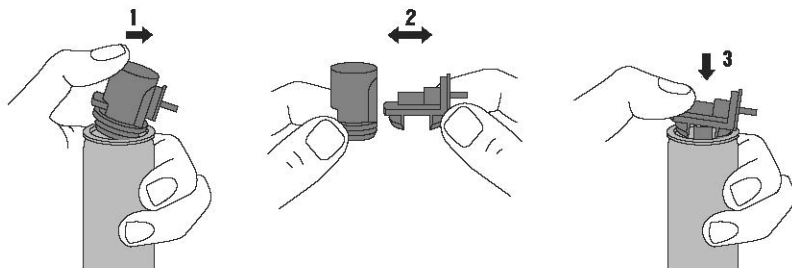

1. Lift the transport safety device, containing the metering valve, away from the gas can.
2. Remove the metering valve from the transport safety device.
3. Fit the metering valve onto the gas can, with the foremost of the two grooves on the lip of the can.
4. Press the metering valve firmly onto the gas can, bringing the rearmost groove towards the lip of the can, until the metering valve is heard to snap into place over the lip and it then lies flush with the can.

8.2 Checking the status of the gas can

1. After inserting the battery, press the **GAS** button without pressing the fastening tool against the working surface.
2. Read the gas can status from the display. → page 10

8.3 Removing the magazine

1. Pull the nail pusher back until it engages.



Note

The magazine cannot be removed if the nail pusher has not been pulled back until it engages in the rearmost position.

2. Remove the loose nail strips from the magazine.
3. Release the magazine locking catch.
4. Pivot the magazine about the pivot point towards the front.
5. Detach the magazine.



WARNING

Risk of finger injury! Fingers could be pinched when the nail pusher is released.

- ▶ When disengaging the nail pusher, do not release it and allow it to jump forward. Guide it forward slowly as far as it will go.

6. Release the nail pusher and guide it forward as far as it will go.

8.4 Fitting the magazine

1. Pull the nail pusher back until it engages.



Note

The magazine cannot be fitted if the nail pusher has not been pulled back until it engages in the rearmost position.

2. Engage the front end of the magazine with the fastening tool.
3. Pivot the magazine towards the fastening tool as far as it will go.
4. Close the magazine locking catch.



WARNING

Risk of finger injury! Fingers could be pinched when the nail pusher is released.

- ▶ When disengaging the nail pusher, do not release it and allow it to jump forward. Guide it forward slowly as far as it will go.

5. Release the nail pusher and guide it forward as far as it will go.

8.5 Removing the fastener guide

1. Remove the battery. → page 12
2. Remove the gas can. → page 12
3. Unload the magazine. → page 12
4. Move the fastener guide release slider to the **EJECT** position.
5. Remove the fastener guide.

8.6 Inserting the fastener guide

1. Remove the gas can. → page 12
2. Remove the battery. → page 12
3. Unload the magazine. → page 12
4. Push the fastener guide release slider in the direction of the arrow into the **EJECT** position and hold it there.



Note

The fastener guide can be inserted only when the slider is held in the **EJECT** position.

5. Slide the fastener guide into the slot in the nose of the fastening tool until it is heard to engage.
6. Check that the fastener guide is seated correctly.

8.7 Removing the support leg

1. Release the support leg engaging mechanism by pressing lightly.
2. Pivot the support leg until it can be withdrawn from the locating groove.

8.8 Fitting the support leg

1. Insert the support leg in the locating groove.
2. Pivot the support leg downwards until it engages.

9 Remediying possible malfunctions

9.1 Removing foreign objects from the area of the fastener guide

1. Remove the battery. → page 12
2. Remove the gas can. → page 12
3. Unload the magazine. → page 12
4. Remove the magazine. → page 13
5. Remove the fastener guide. → page 14
6. Remove all foreign objects from the area of the fastener guide.
7. Insert the fastener guide. → page 14
8. Fit the magazine. → page 13

10 Care and maintenance

10.1 Caring for the fastening tool

- ▶ Clean the fastening tool with a cloth at regular intervals (see also → page 15).
- ▶ Keep the grip areas free from oil and grease.
- ▶ Do not use spray equipment, pressure jet washers or running water for cleaning.
- ▶ Do not use cleaning agents containing silicone.
- ▶ Do not use sprays or similar lubricating and cleaning agents.
- ▶ Never operate the fastening tool if the cooling air slots are blocked.

10.2 Cleaning the fastening tool



Note

The fastening tool must be cleaned and serviced regularly. We recommend that a cleaning service is carried out, at the latest, after driving 25,000 fasteners.

- ▶ Clean the fastening tool, or have it cleaned, if malfunctions such as misfiring occur increasingly.
- ▶ For cleaning, use the cleaning set (available as an accessory) and observe the illustrated cleaning instructions enclosed with it.

10.3 Maintenance

- ▶ To help ensure safe and reliable operation, use only genuine Hilti spare parts and consumables. Spare parts, consumables and accessories approved by Hilti for use with the product can be found at your local **Hilti Center** or online at: **www.hilti.group**.
- ▶ Check all external parts of the fastening tool for signs of damage at regular intervals and make sure that all the controls function correctly.
- ▶ Do not use the fastening tool if parts are damaged or if the controls do not function correctly.
- ▶ Have a defective fastening tool repaired by **Hilti Service**.



10.4 Checks after care and maintenance work

- ▶ After maintenance, check that the fastener guide is fitted → page 14.

11 Troubleshooting

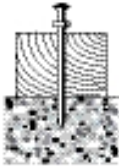
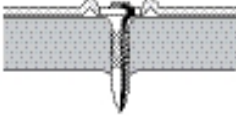
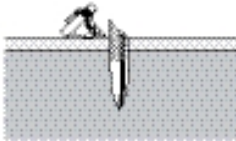
If the trouble you are experiencing is not listed in this table or you are unable to remedy the problem by yourself, please contact **Hilti Service**.

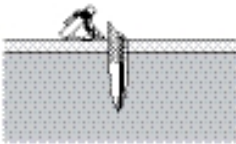
Malfunction	Possible cause	Action to be taken
 <p>Fasteners are frequently driven to inadequate depth.</p>	Driving power is too low.	▶ Move the fastener driving depth adjustment slider to the + position.
	The fasteners are too long.	▶ Use shorter fasteners.
	The supporting material is too hard.	▶ Consider using a DX fastening tool.
 <p>Fasteners are frequently driven too deeply.</p>	Driving power is too high.	▶ Move the fastener driving depth adjustment slider to the - position.
	The fasteners are too short.	▶ Use longer fasteners.
 <p>Fasteners break.</p>	Driving power is too low.	▶ Move the fastener driving depth adjustment slider to the + position.
	The fasteners are too long.	▶ Use shorter fasteners.
	The supporting material is too hard.	▶ Consider using a DX fastening tool.
	The fastener guide is not held perpendicular to the working surface.	▶ On an even surface use the support leg and ensure correct contact with the surface (see "Support leg" → page 9).

Malfunction	Possible cause	Action to be taken
 <p>Fasteners break.</p>	<p>The fastener guide is not held perpendicular to the working surface.</p>	<ul style="list-style-type: none"> ▶ Press the nose of the fastening tool against the working surface, keeping the fastener guide perpendicular to the surface (see "Driving nails" → page 12).
 <p>Fasteners bend.</p>	<p>Driving power is too low.</p> <p>The fasteners are too long.</p> <p>The fastener guide is not held perpendicular to the working surface.</p>	<ul style="list-style-type: none"> ▶ Move the fastener driving depth adjustment slider to the \pm position. ▶ Use shorter fasteners. ▶ On an even surface use the support leg and ensure correct contact with the surface (see "Support leg" → page 9). ▶ Press the nose of the fastening tool against the working surface, keeping the fastener guide perpendicular to the surface (see "Driving nails" → page 12).
 <p>Fasteners do not hold in steel base material.</p>	<p>The supporting material is too thin.</p>	<ul style="list-style-type: none"> ▶ Use a different fastening method.
<p>The content of the gas can is inadequate for the number of fasteners in the package.</p>	<p>High gas consumption due to frequent compression of the tool nosepiece without driving a fastener.</p>	<ul style="list-style-type: none"> ▶ Avoid compressing the tool nosepiece without driving a fastener.
<p>The fastener guide hasn't fully extended after driving a fastener.</p>	<p>A fastener has jammed in the fastener guide.</p>	<ul style="list-style-type: none"> ▶ Remove the fastener guide → page 14. ▶ Release the jammed fastener. ▶ Clean the fastener guide. ▶ Remove foreign matter from the area of the fastener guide.
<p>Fastener driving failure rate is too high.</p>	<p>The fastener guide is not held perpendicular to the working surface.</p> <p>Wrong type of fastener used.</p> <p>The supporting material is too hard.</p>	<ul style="list-style-type: none"> ▶ On an even surface use the support leg and ensure correct contact with the surface (see "Support leg" → page 9). ▶ Press the nose of the fastening tool against the working surface, keeping the fastener guide perpendicular to the surface (see "Driving nails" → page 12). ▶ Use a suitable type of fastener. ▶ Consider using a DX fastening tool.
<p>No fastener is driven.</p>	<p>The nail pusher was not moved forward.</p>	<ul style="list-style-type: none"> ▶ Release the nail pusher and guide it forward as far as it will go.

Malfunction	Possible cause	Action to be taken
No fastener is driven.	Inadequate number of nails in the magazine.	▶ Load the magazine. → page 11
	Nail transport malfunction.	▶ Check the nail strip and, if damaged, use a new one.
		▶ Clean the magazine and the fastener guide.
	The battery is discharged.	▶ Change the battery.
	Empty gas can	▶ Check the status of the gas can. → page 13
	LED 1 lights red	▶ Check the status of the gas can. → page 13
	Incorrect piston position due to lifting the tool away too soon after driving the fastener.	▶ Keep the tool pressed against the surface for longer.
	Incorrect piston position due to foreign-matter build-up	▶ Clean the fastening tool. → page 15
	The tool doesn't fire due to a dirty spark plug.	▶ Clean the fastening tool. → page 15
	Foreign object in the area of the fastener guide.	▶ Remove foreign objects from the area of the fastener guide. → page 14
	Electronic fault.	▶ Remove the gas can and then reinsert it. If the problem persists, use a new gas can.
▶ Remove the battery and then reinsert it.		
No fastener is driven (or driven only intermittently).	Ambient conditions are outside the permissible range.	▶ Make sure that the permissible ranges, in accordance with the technical data, are observed.
	The gas can temperature is outside the permissible range.	▶ Make sure that the permissible ranges, in accordance with the technical data, are observed.
	The tool was not lifted completely away from the surface after driving a fastener.	▶ Lift the fastening tool completely away from the working surface after driving a fastener.
A fastener cannot be removed from the fastener guide.	A fastener has jammed in the fastener guide.	<ul style="list-style-type: none"> ▶ Remove the fastener guide → page 14. ▶ Release the jammed fastener. ▶ Clean the fastener guide. ▶ Remove foreign matter from the area of the fastener guide.

12 Disposal

 Most of the materials from which **Hilti** tools and appliances are manufactured can be recycled. The materials must be correctly separated before they can be recycled. In many countries, your old tools, machines or appliances can be returned to **Hilti** for recycling. Ask **Hilti** Service or your Hilti representative for further information.



- ▶ Disposal of electric tools or appliances together with household waste is not permissible.

13 Manufacturer's warranty

- ▶ Please contact your local **Hilti** representative if you have questions about the warranty conditions.



Hilti Aktiengesellschaft
Feldkircherstraße 100
9494 Schaan | Liechtenstein

GX 2 (01)

[2015]

2014/53/EU

EN ISO 12100

2011/65/EU

EN 792-13

2006/42/EG

EN 301489-1 V2.2.0

EN 301489-3 V2.1.1

EN 300330 V2.1.1

Schaan, 04/2017

Norbert Wohlwend

Head of Quality Management
Business Unit Direct Fastening

Dr. Lars Taenzer

Head of BU Direct Fastening
Business Unit Direct Fastening



Hilti Corporation

LI-9494 Schaan

Tel.: +423/234 21 11

Fax: +423/234 29 65

www.hilti.group

Hilti = registered trademark of Hilti Corp., Schaan



20170825